

MINIATURE RELAY

1 POLE - 1 to 2 A (For Signal Switching)

MZ Series

■ FEATURES

- Subminiature size
 - Standard and high sensitivity types available
 - UL, CSA recognized
 - FCC rules and regulations part 68
 - Dielectric strength 1,500 V between coil and contacts
 - High reliability-bifurcated contacts available
 - DIL pitch terminals
 - Plastic sealed type
 - RoHS compliant.
- Please see page 7 for more information



■ PARTNUMBER INFORMATION

[Example] $\frac{MZ}{(a)}$ $\frac{F}{(b)}$ - $\frac{12}{(c)}$ $\frac{W}{(d)}$ $\frac{HG}{(e)}$ - $\frac{K}{(f)}$ - $\frac{U}{(g)}$

(a)	Relay type	MZ	: MZ-Series
(b)	Dielectric function	Nil F	: Standard type : High dielectric strength type
(c)	Coil rated voltage	12	: 1.5.....48 VDC Coil rating table at page 3
(d)	Contact configuration	Nil D W	: 1A single : 2A single (without MZF) : 1A bifurcated
(e)	Coil type	HG HS	: Standard type (without MZ-D) (450-500mW) : High sensitivity type (without MZF / MZ-D) (190-270mW)
(f)	Enclosure	Nil K	: Flux free type : Plastic sealed type
(g)	UL, CSA standard	Nil U	: Non UL, CSA approved : UL, CSA approved

Note: For movable and stationary contact with gold overlay type, add suffix "-OH".

MZ SERIES

■ SPECIFICATION

Item			Standard type			High sensitivity type		
			Single		Bifurcated	Single	Bifurcated	
			MZ - () D	MZ- () HG	MZ-() WHG	MZ - () HS	MZ-() WHS	
Contact Data	Configuration		1 form C (SPDT)					
	Material		Gold-overlay silver nickel	Gold overlay silver-palladium				
	Resistance (initial)		Max. 100 mΩ at 6 VDC, 1A					
	Contact rating (resistive)		2A, 24VDC 1A, 120VAC	1A, 24VDC 0.5A, 120VAC				
	Max. carrying current		2A					
	Max. switching voltage		120VAC, 60VDC					
	Max. switching power		120VA / 48W		60VA / 24W			
	Max. switching current		2A		1A			
	Min. switching load*		1mA, 1 VDC		0.1mA, 100 mVDC	1mA, 1VDC		0.1mA, 100 mVDC
	Capacitance (at 10 MHz)		Approximately 0.8 pF (between open contacts, adjacent contacts) Approximately 7.5 pF (between coil and contacts)					
Life	Mechanical		Min. 20 x 10 ⁶ operations					
	Electrical		1A, 120VAC: min. 100 x 10 ³ ops. 2A, 24VDC: min. 200 x 10 ³ ops. min.	0.5A, 120VAC: min. 200 x 10 ³ operations 1A, 24VAC: min. 500 x 10 ³ operations				
Coil Data	Rated power (at 20 °C)		450 - 500 mW			190 - 270 mW		
	Operate power (at 20 °C)		220 - 250 mW			100 - 130 mW		
	Operating temperature range		-30 °C to +55 °C (no frost)			-30 °C to +75 °C		
Timing Data	Operate (at nominal voltage)		Max. 6 ms					
	Release (at nominal voltage)		Max. 3 ms					
Insulation	Isolation (initial)		Min. 100MΩ at 500VDC					
	Dielectric strength	Open contacts	Standard: 500VAC, 1min. High Isolation: 1,000VAC, 1min.					
		Contacts to coil	Standard: 500VAC, 1min. High Isolation: 1,500VAC, 1min.					
	Surge strength	Coil to contacts	1,500V / 1 x 40μs standard wave					
Other	Vibration resistance	Misoperation	10 to 55Hz double amplitude 3.28 mm					
		Endurance	10 to 55Hz double amplitude 3.28 mm					
	Shock	Misoperation	Min. 100m/s ² (11 ± 1ms)					
		Endurance	Min. 1,000m/s ² (6 ± 1ms)					
	Weight	Approximately 3.5 g						

* Minimum switching loads mentioned above are reference values. Please perform the confirmation test with actual load before production since reference values may vary according to switching frequencies, environmental conditions and expected reliability levels.

■ COIL RATING

Standard type

Coil Code	Rated Coil Voltage (VDC)	Coil Resistance +/- 10% (Ohm)	Must Operate Voltage (VDC) *	Must Release Voltage (VDC) *	Rated Power (mW)
1.5	1.5	5	1.05	0.08	450
3	3	20	2.1	0.15	
4.5	4.5	45	3.15	0.23	
5	5	56	3.5	0.25	
6	6	80	4.2	0.3	
9	9	180	6.3	0.45	
12	12	320	8.4	0.6	
18	18	720	12.6	0.9	
24	24	1,280	16.8	1.2	500
48	48	4,600	33.6	2.4	

High sensitive type

Coil Code	Rated Coil Voltage (VDC)	Coil Resistance +/- 10% (Ohm)	Must Operate Voltage (VDC) *	Must Release Voltage (VDC) *	Rated Power (mW)
1.5	1.5	12	1.05	0.08	190
3	3	45	2.1	0.15	200
4.5	4.5	100	3.15	0.23	
5	5	120	3.5	0.25	
6	6	180	4.2	0.3	
9	9	400	6.3	0.45	
12	12	700	8.4	0.6	
15	15	1,100	10.5	0.75	
18	18	1,600	12.6	0.9	
24	24	2,800	16.8	1.2	270
48	48	8,500	33.6	2.4	

Note: All values in the table are valid for 20°C and zero contact current.

* Specified operate values are valid for pulse wave voltage.

■ SAFETY STANDARDS

Type	Compliance	Contact rating
UL	UL 508, UL 60950-1	Flammability: UL 94-V0 (plastics)
	E 45026	[1A] 0.5A, 120VAC (resistive)
CSA	C22.2 No. 14 LR 35579	1A, 24VDC (resistive)
		[2A] 1A, 120VAC (resistive) 2A, 30VDC (resistive)

CHARACTERISTIC DATA

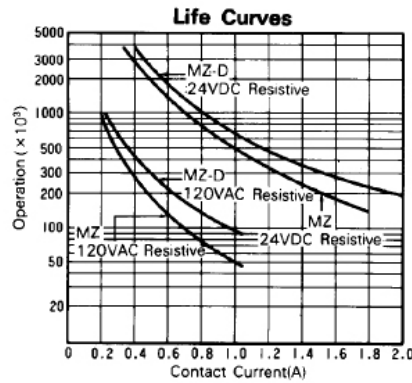
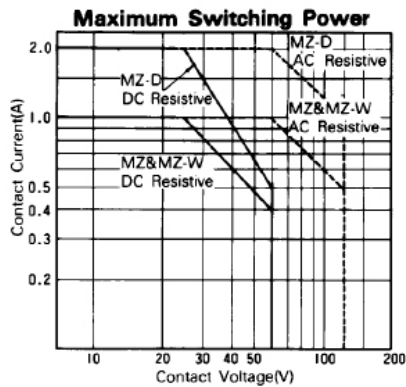
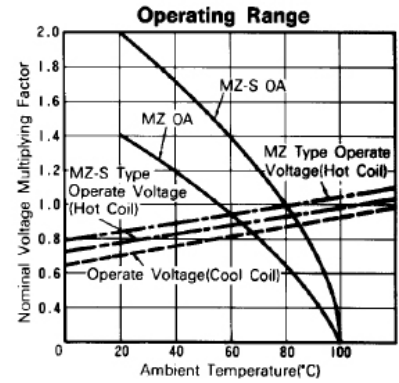
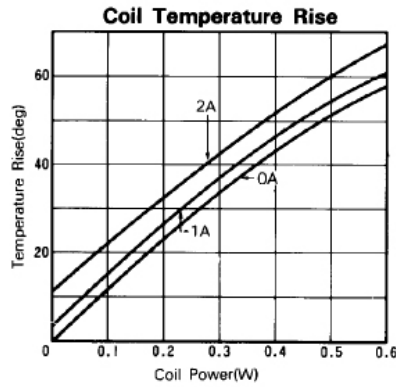
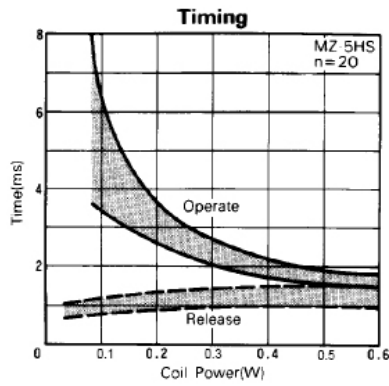

REFERENCE DATA

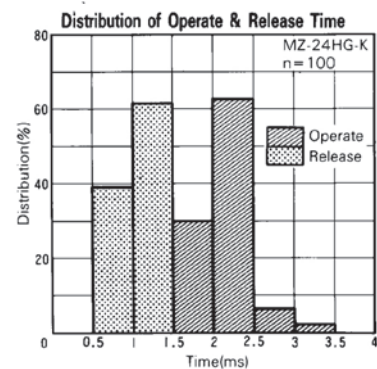
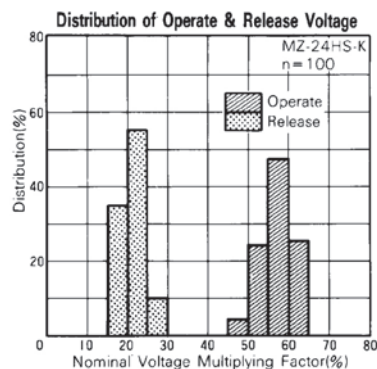
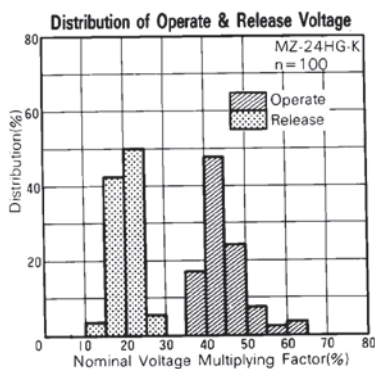

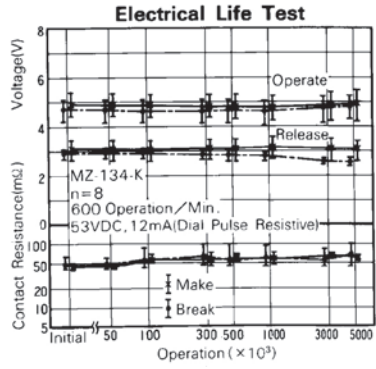
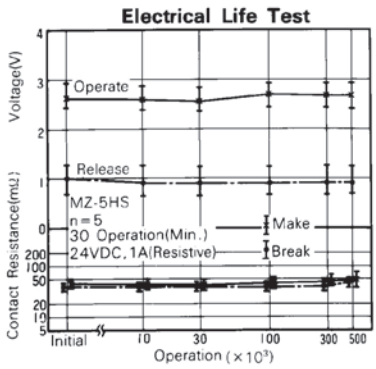
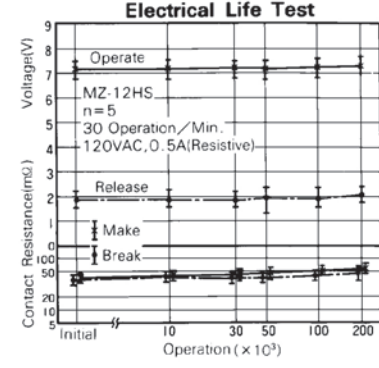
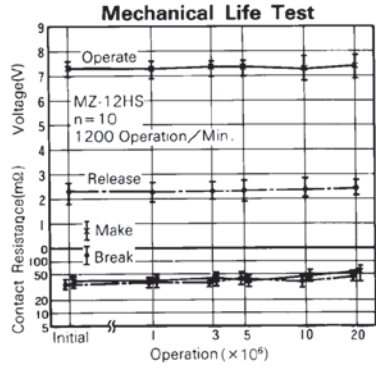
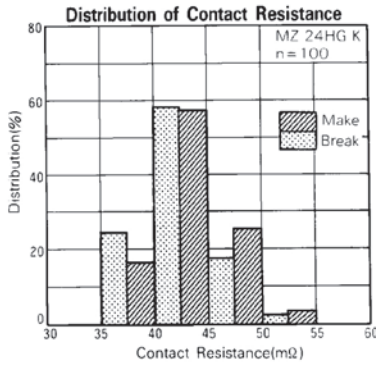
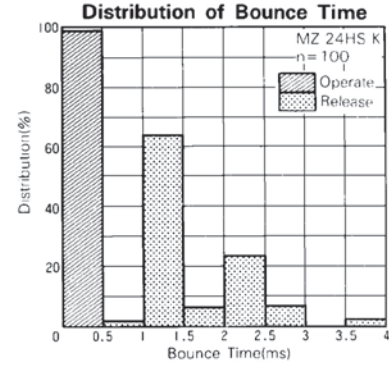
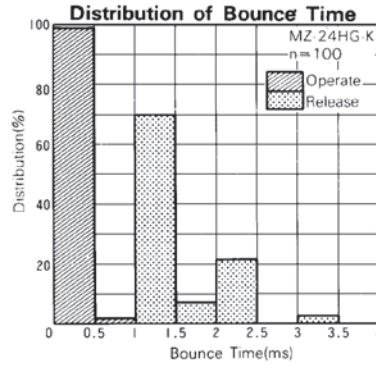
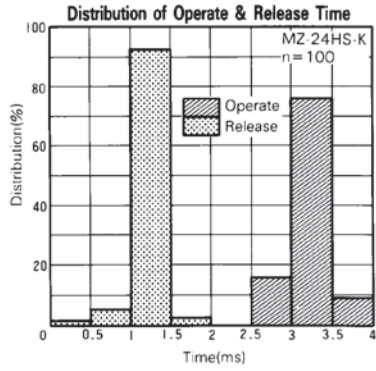

■ DIMENSIONS

- Dimensions

MZ (F) type (Flux free type)

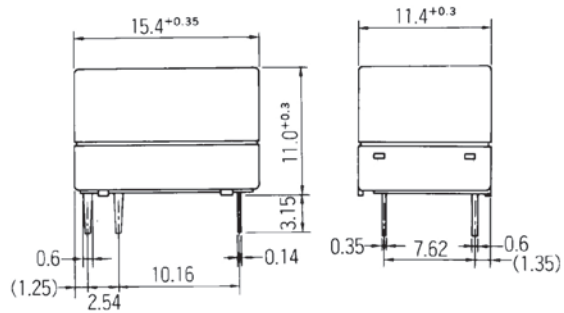

- Schematics (BOTTOM VIEW)

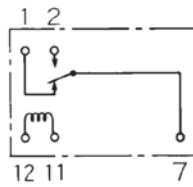

- PC board mounting hole layout (BOTTOM VIEW)

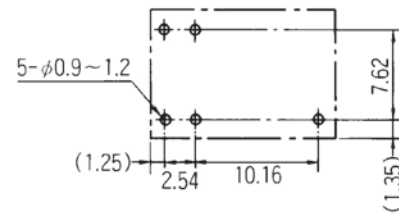

MZ (F)-K type (Plastic sealed type)

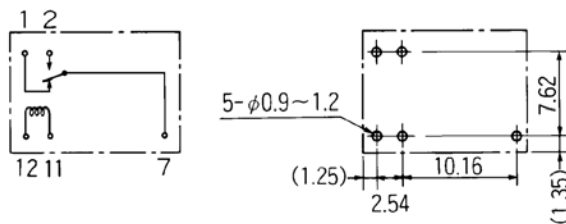

Unit: mm

RoHS Compliance and Lead Free Information

1. General Information

- All relays produced by Fujitsu Components are compliant with RoHS directive 2011/65/EU including amendments.
- Cadmium as used in electrical contacts is exempted from the RoHS directives.
As per Annex III of directive 2011/65/EU.
- All relays are lead-free. Please refer to Lead-Free Status Info for older date codes at:
<http://www.fujitsu.com/downloads/MICRO/fcai/relays/lead-free-letter.pdf>
- Lead free solder plating on relay terminals is Sn-3.0Ag-0.5Cu, unless otherwise specified.
This material has been verified to be compatible with PbSn assembly process.

2. Recommended Lead Free Solder Condition

- Recommended solder Sn-3.0Ag-0.5Cu.

Flow Solder Condition:

Pre-heating: maximum 120°C
within 90 sec.
Soldering: dip within 5 sec. at
255°C ± 5°C solder bath
Relay must be cooled by air immediately
after soldering

Solder by Soldering Iron:

Soldering Iron 30-60W
Temperature: maximum 350-360°C
Duration: maximum 3 sec.

We highly recommend that you confirm your actual solder conditions

3. Moisture Sensitivity

- Moisture Sensitivity Level standard is not applicable to electromechanical relays, unless otherwise indicated.

4. Tin Whiskers

- Dipped SnAgCu solder is known as presenting a low risk to tin whisker development. No considerable length whisker was found by our in house test.

Fujitsu Components International Headquarter Offices

Japan

Fujitsu Component Limited
Gotanda-Chuo Building
3-5, Higashigotanda 2-chome, Shinagawa-ku
Tokyo 141, Japan
Tel: (81-3) 5449-7010
Fax: (81-3) 5449-2626
Email: promothq@ft.ed.fujitsu.com
Web: www.fcl.fujitsu.com

North and South America

Fujitsu Components America, Inc.
250 E. Caribbean Drive
Sunnyvale, CA 94089 U.S.A.
Tel: (1-408) 745-4900
Fax: (1-408) 745-4970
Email: components@us.fujitsu.com
Web: <http://us.fujitsu.com/components>

Europe

Fujitsu Components Europe B.V.
Diamantlaan 25
2132 WV Hoofddorp
Netherlands
Tel: (31-23) 5560910
Fax: (31-23) 5560950
Email: info@fceu.fujitsu.com
Web: emea.fujitsu.com/components/

Asia Pacific

Fujitsu Components Asia Ltd.
102E Pasir Panjang Road
#01-01 Citilink Warehouse Complex
Singapore 118529
Tel: (65) 6375-8560
Fax: (65) 6273-3021
Email: fcal@fcal.fujitsu.com
Web: <http://www.fujitsu.com/sg/services/micro/components/>

©2014 Fujitsu Components Europe B.V. All rights reserved. All trademarks or registered trademarks are the property of their respective owners.

The contents, data and information in this datasheet are provided by Fujitsu Component Ltd. as a service only to its user and only for general information purposes.

The use of the contents, data and information provided in this datasheet is at the users' own risk.

Fujitsu has assembled this datasheet with care and will endeavor to keep the contents, data and information correct, accurate, comprehensive, complete and up to date.

Fujitsu Components Europe B.V. and affiliated companies do however not accept any responsibility or liability on their behalf, nor on behalf of its employees, for any loss or damage, direct, indirect or consequential, with respect to this datasheet, its contents, data, and information and related graphics and the correctness, reliability, accuracy, comprehensiveness, usefulness, availability and completeness thereof.

Nor do Fujitsu Components Europe B.V. and affiliated companies accept on their behalf, nor on behalf of its employees, any responsibility or liability for any representation or warrant of any kind, express or implied, including warranties of any kind for merchantability or fitness for particular use, with respect to these datasheets, its contents, data, information and related graphics and the correctness, reliability, accuracy, comprehensiveness, usefulness, availability and completeness thereof. Rev. May 21, 2014

Компания «Life Electronics» занимается поставками электронных компонентов импортного и отечественного производства от производителей и со складов крупных дистрибьюторов Европы, Америки и Азии.

С конца 2013 года компания активно расширяет линейку поставок компонентов по направлению коаксиальный кабель, кварцевые генераторы и конденсаторы (керамические, пленочные, электролитические), за счёт заключения дистрибьюторских договоров

Мы предлагаем:

- Конкурентоспособные цены и скидки постоянным клиентам.
- Специальные условия для постоянных клиентов.
- Подбор аналогов.
- Поставку компонентов в любых объемах, удовлетворяющих вашим потребностям.
- Приемлемые сроки поставки, возможна ускоренная поставка.
- Доставку товара в любую точку России и стран СНГ.
- Комплексную поставку.
- Работу по проектам и поставку образцов.
- Формирование склада под заказчика.
- Сертификаты соответствия на поставляемую продукцию (по желанию клиента).
- Тестирование поставляемой продукции.
- Поставку компонентов, требующих военную и космическую приемку.
- Входной контроль качества.
- Наличие сертификата ISO.

В составе нашей компании организован Конструкторский отдел, призванный помогать разработчикам, и инженерам.

Конструкторский отдел помогает осуществить:

- Регистрацию проекта у производителя компонентов.
- Техническую поддержку проекта.
- Защиту от снятия компонента с производства.
- Оценку стоимости проекта по компонентам.
- Изготовление тестовой платы монтаж и пусконаладочные работы.



Тел: +7 (812) 336 43 04 (многоканальный)

Email: org@lifeelectronics.ru