

# LED Driver

## LNE-185W Series / LNE-□V185W□□□

# LNE

### Highlights & Features

- Universal AC input voltage from 90-305Vac
- High efficiency > 94.0%
- With IP65/ 67 protection for most outdoor applications
- Built-in Active PFC and conforms to harmonic current IEC/EN 61000-3-2, Class C
- Adjustable constant current level through internal potentiometer
- Common mode 6kV and differential mode 4kV surge immunity

### Safety Standards



CB Certified for worldwide use

**Model Number:** LNE-□V185W□□□

**Unit Weight:** 1.04 kg

**Dimensions (L x W x D):** 228 x 68 x 38.8 mm



### General Description

Delta LED drivers come in different series to suit different application needs. The LNE series features adjustable output voltage and current level. All the models come in full corrosion resistance aluminum casing and major international safety certifications. LNE series offers the capability to achieve different level of LED brightness via built-in dimming function to meet various application and energy optimization needs. The products are designed and rigorously tested to work with various indoor and outdoor LED lighting conditions. Featuring high surge immunity (CM: 6kV, DM: 4kV) and complying to IP65/IP67 make Delta LNE series an essential part of an energy efficient LED lighting power solution for both indoor and outdoor applications.

### Model Information

#### LNE LED Driver

| Model Number   | Input Voltage Range                                    | Output Voltage | Output Current |
|----------------|--|----------------|----------------|
| LNE-12V185W□□□ | 90-305Vac (LNE-□V185W□A□)<br>90-277Vac (LNE-□V185W□C□) | 12Vdc          | 13.00A         |
| LNE-24V185W□□□ |  | 24Vdc          | 7.80A          |
| LNE-36V185W□□□ |  | 36Vdc          | 5.20A          |
| LNE-48V185W□□□ |  | 48Vdc          | 3.90A          |
| LNE-54V185W□□□ |  | 54Vdc          | 3.45A          |

### Model Numbering

| LNE -      | □V  | 185W                                | □  | □   | □                              |
|------------|---|-------------------------------------|--|---|--------------------------------|
| LED Driver | Output Voltage<br>12V<br>24V<br>36V<br>48V<br>54V | Output Power<br>(185W series model) | Package Type<br>A – IP65 with adjustable VR<br>D – IP67 with dimming and without adjustable VR | Safety Approval<br>A – UL approval<br>C – ENEC, CE and CCC approval | Variable<br>A – Delta standard |

# LED Driver

## LNE-185W Series / LNE-□V185W□□□

### Specifications

| Model Number | LNE-12V185W□ | LNE-24V185W□ | LNE-36V185W□ | LNE-48V185W□ | LNE-54V185W□ |
|--------------|--------------|--------------|--------------|--------------|--------------|
|--------------|--------------|--------------|--------------|--------------|--------------|

### Input Ratings / Characteristics

|                                 |   |            |            |            |            |            |
|---------------------------------|---|------------|------------|------------|------------|------------|
| Nominal Input Voltage           | 100-277Vac (LNE-□V185W□A□)<br>100-240Vac (LNE-□V185W□C□)  |            |            |            |            |            |
| Input Voltage Range             | 90-305Vac (LNE-□V185W□A□)<br>90-277Vac (LNE-□V185W□C□)  |            |            |            |            |            |
| Nominal Input Frequency         | 50-60Hz   |            |            |            |            |            |
| Input Frequency Range           | 47-63Hz   |            |            |            |            |            |
| Input Current                   | 1.80A typ. @ 115Vac, 0.60A typ. @ 230Vac, 0.70A typ. @ 277Vac (for 12V)<br>2.10A typ. @ 115Vac, 0.90A typ. @ 230Vac, 0.80A typ. @ 277Vac (for 24V to 54V) |            |            |            |            |            |
| Efficiency at 100% Load         | 115Vac  | 89.0% typ. | 91.0% typ. | 91.0% typ. | 91.5% typ. | 91.5% typ. |
|                                 | 230Vac  | 91.5% typ. | 93.5% typ. | 93.5% typ. | 94.0% typ. | 94.0% typ. |
|                                 | 277Vac  | 91.5% typ. | 93.5% typ. | 93.5% typ. | 94.0% typ. | 94.0% typ. |
| Max Inrush Current (Cold Start) | 65A typ. @ 230Vac   |            |            |            |            |            |
| Power Factor At 100% load       | 0.98 typ. @ 115Vac<br>0.95 typ. @ 230Vac<br>0.92 typ. @ 277Vac  |            |            |            |            |            |
| Leakage Current                 | < 0.75mA @ 277Vac   |            |            |            |            |            |

# LED Driver

## LNE-185W Series / LNE-□V185W□□□

### Power Factor Vs Output Load

LNE-12V185W□

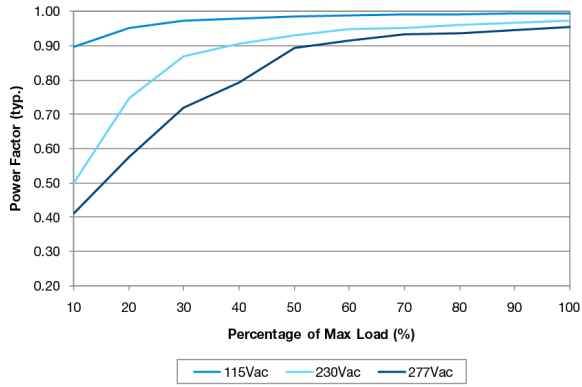

LNE-24V185W□

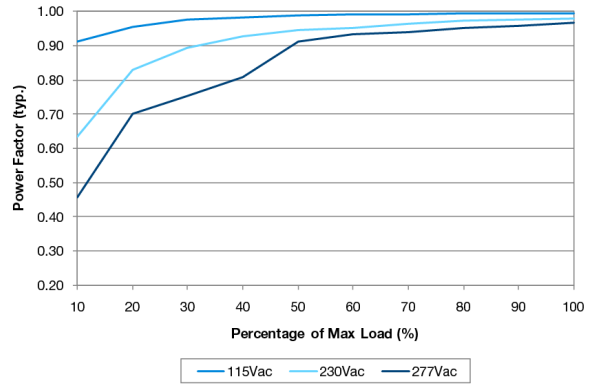

LNE-36V185W□

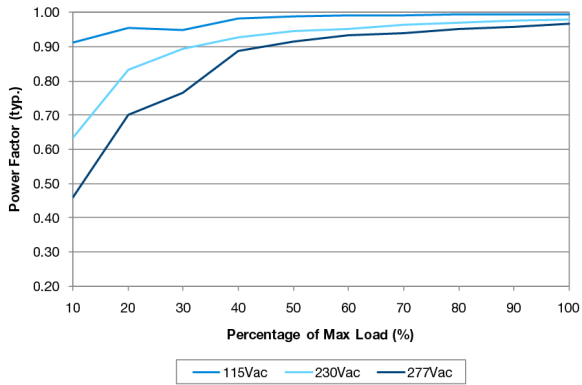

LNE-48V185W□

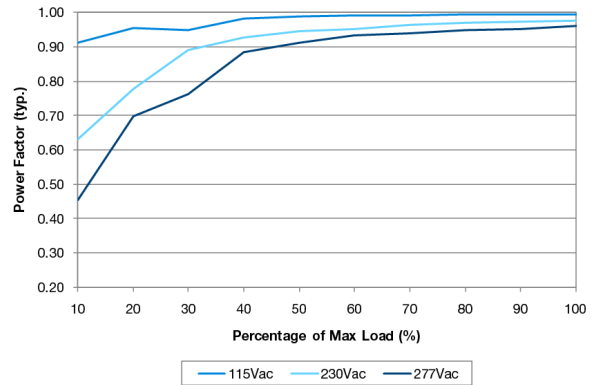

LNE-54V185W□

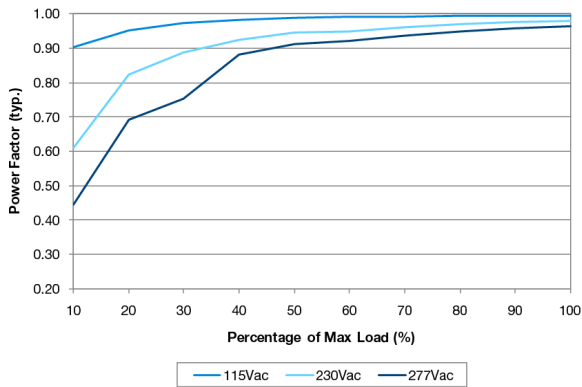

# LED Driver

## LNE-185W Series / LNE-□V185W□□□

### Efficiency Vs Output Load at Nominal Output Voltage

LNE-12V185W□

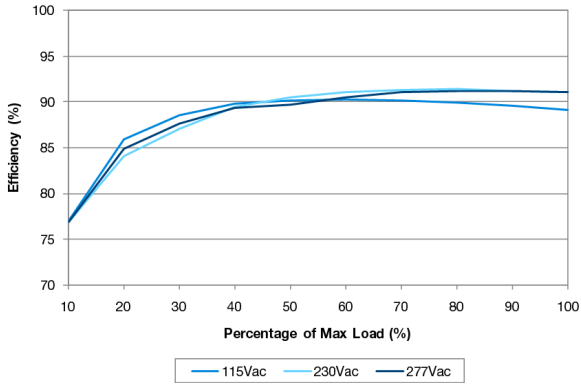

LNE-24V185W□

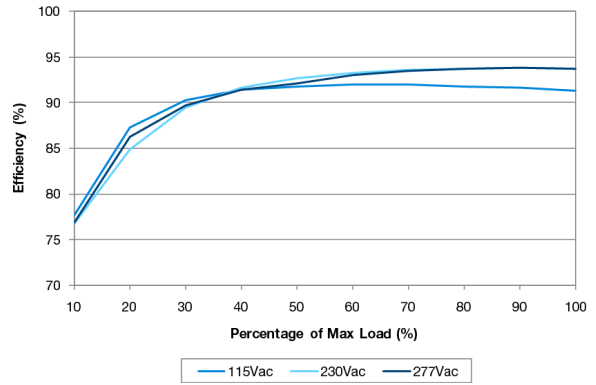

LNE-36V185W□

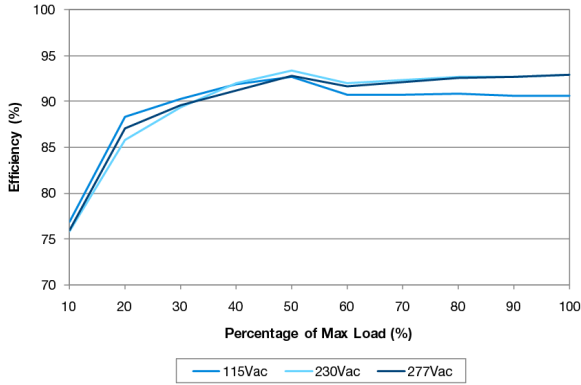

LNE-48V185W□

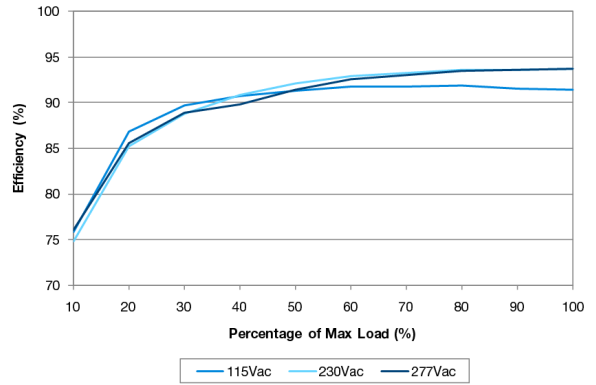

LNE-54V185W□

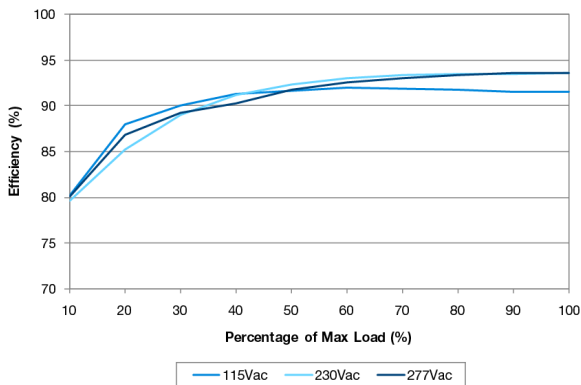

**LED Driver****LNE-185W Series / LNE-□V185W□□□**

| Model Number | LNE-12V185W□ | LNE-24V185W□ | LNE-36V185W□ | LNE-48V185W□ | LNE-54V185W□ |
|--------------|--------------|--------------|--------------|--------------|--------------|
|--------------|--------------|--------------|--------------|--------------|--------------|

**Output Ratings / Characteristics**

|  |  |            |            |            |             |
|--|--|------------|------------|------------|-------------|
| Nominal Output Voltage                                   | 12Vdc  | 24Vdc      | 36Vdc      | 48Vdc      | 54Vdc       |
| Output Voltage Adjustment Range*                         | 10.8-13.5V   | 22.0-27.0V | 33.0-40.0V | 43.0-53.0V | 49.0-58.0V  |
| Nominal Output Current                                   | 13.0A  | 7.8A       | 5.2A       | 3.9A       | 3.45A       |
| Output Current Adjustment Range*                         | 6.5-13.0A  | 3.9-7.8A   | 2.6~5.2A   | 1.95-3.9A  | 1.725-3.45A |
| Output Power   | 156W   | 187.2W     | 187.2W     | 187.2W     | 186.3W      |
| Line Regulation  | ± 0.5% (@ 100-277Vac input)  |            |            |            |             |
| Load Regulation<br>(@ 100-277Vac input, 0-100% load)     | ± 2.0%   | ± 1.0%     | ± 1.0%     | ± 0.5%     | ± 0.5%      |
| PARD (20MHz)   | < 150mVpp  | < 150mVpp  | < 200mVpp  | < 200mVpp  | < 200mVpp   |
| Rise Time  | < 50ms @ 115Vac & 230Vac & 277Vac  |            |            |            |             |
| Start-up Time  | 1000ms typ. @ 115Vac (100% load)<br>500ms typ. @ 230Vac & 277Vac (100% load) |            |            |            |             |
| Hold-up Time   | 16ms typ. @ 115Vac & 230Vac & 277Vac (100% load)                             |            |            |            |             |
| Dynamic Response<br>(Overshoot & Undershoot O/P Voltage) | ± 5% @ 0-100% load<br>(Slew Rate: 0.1A/μS)                                   |            |            |            |             |

\* For LNE-185WA package type only.

# LED Driver

## LNE-185W Series / LNE-□V185W□□□

| Model Number | LNE-12V185W□ | LNE-24V185W□ | LNE-36V185W□ | LNE-48V185W□ | LNE-54V185W□ |
|--------------|--------------|--------------|--------------|--------------|--------------|
|--------------|--------------|--------------|--------------|--------------|--------------|

### Mechanical

|                                      |                                    |     |                             |  |  |
|--------------------------------------|------------------------------------|-----|-----------------------------|--|--|
| Casing                               | Aluminium                          |     |                             |  |  |
| Dimensions (L x W x D)               | 228 x 68 x 38.8 mm                 |     |                             |  |  |
| Unit Weight                          | 1.04 kg                            |     |                             |  |  |
| Cooling System                       | Convection                         |     |                             |  |  |
| Wire                                 | Input                              | VDE | H05RN-F3G1.0mm <sup>2</sup> | Line: Brown, Neutral: Blue, PE: Green/Yellow |  |
|                                      |                                    | UL  | SJTW 18AWGX3C               | Line: Brown, Neutral: Blue, PE: Green/Yellow |  |
|                                      | Output                             | VDE | H07RN-F2x1.5mm <sup>2</sup> | Positive: Red, Negative: Black               |  |
|                                      |                                    | UL  | SJTW 14AWGX2C               | Positive: Red, Negative: Black               |  |
|                                      | Dimming                            | VDE | H05RN-F2x1.0mm <sup>2</sup> | Positive: White, Negative: Blue              |  |
|                                      |                                    | UL  | SJTW 18AWGX2C               | Positive: White, Negative: Blue              |  |
| Noise<br>(1 Meter from power supply) | Sound Pressure Level (SPL) < 25dbA |     |                             |  |  |

### Environment

|                               |  |                |
|-------------------------------|--|----------------|
| Surrounding Air Temperature   | Operating  | -40°C to +70°C |
|                               | Storage  | -40°C to +85°C |
| Power De-rating               | > 60°C de-rate power by 4% / °C<br>< 100Vac de-rate power by 2% / Vac                      |                |
| Operating Humidity            | 5 to 95% RH (Non-Condensing)   |                |
| Operating Altitude            | 0 to 3,000 Meters  |                |
| Shock Test<br>(Non-Operating) | IEC 60068-2-27, Half Sine Wave: 50G for a duration of 11ms, 3 shocks for each 3 directions |                |
| Vibration<br>(Non-Operating)  | IEC 60068-2-6, Random: 5Hz to 500Hz (2.09G); 20 min per axis for all X, Y, Z direction     |                |
| Pollution Degree              | 2  |                |

### Protections

|                          |  |                        |                        |                        |                        |
|--------------------------|--|------------------------|------------------------|------------------------|------------------------|
| Overvoltage              | 13.8-16.8V, Latch Mode   | 27.6-33.6V, Latch Mode | 41.4-50.4V, Latch Mode | 55.2-67.2V, Latch Mode | 62.1-75.6V, Latch Mode |
| Overload / Overcurrent   | 95-108% of rated load current, constant current limit<br>Auto-Recovery when the fault is removed |                        |                        |                        |                        |
| Over Temperature         | Hiccup Mode, Auto-Recovery when the fault is removed   |                        |                        |                        |                        |
| Short Circuit            | Constant current limit, Auto-Recovery when the fault is removed                                  |                        |                        |                        |                        |
| Degree of Protection     | IP65 (LNE-□V185W A□□)<br>IP67 (LNE-□V185W D□□)   |                        |                        |                        |                        |
| Protection Against Shock | Class I with PE* connection  |                        |                        |                        |                        |

\*PE: Primary Earth

# LED Driver

## LNE-185W Series / LNE-□V185W□□□

| Model Number | LNE-12V185W□ | LNE-24V185W□ | LNE-36V185W□ | LNE-48V185W□ | LNE-54V185W□ |
|--------------|--------------|--------------|--------------|--------------|--------------|
|--------------|--------------|--------------|--------------|--------------|--------------|

### Reliability Data

|                        |   |
|------------------------|---|
| MTBF                   | > 700,000 hrs. as per Telcordia SR-332<br>I/P: 115Vac, O/P: 100% load, Ta: 25°C |
| Expected Cap Life Time | 10 years (115Vac & 230Vac, 50% load @ 40°C)                                     |

### Safety Standards / Directives

|                    |  |          |
|--------------------|--|----------|
| Electrical Safety  | CB scheme to IEC 61347-1, IEC 61347-2-13<br>ENEC to EN 61347-1, EN 61347-2-13<br>cRUus to UL 8750 (LNE-□V185W□A□)<br>CCC to GB19519.1, GB19510.14<br>Compliance to IEC/EN/UL 60950-1 |          |
| CE                 | In conformance with EMC Directive 2004/108/EC and Low Voltage Directive 2006/95/EC   |          |
| Material and Parts | RoHS Directive 2011/65/EU Compliant  |          |
| Galvanic Isolation | Input to Output  | 3.85kVac |
|                    | Input to Ground  | 2.0kVac  |
|                    | Output to Ground   | 1.5kVac  |

### EMC

|                                   |   |
|-----------------------------------|---|
| EMC / Emissions                   | EN 55015 Class B;<br>Compliance to CISPR 22, EN 55022, FCC Title 47: Class B  |
| Immunity to                       | Compliance to EN 61547, EN 55024  |
| Electrostatic Discharge           | IEC 61000-4-2<br>Level 4 Criteria A <sup>1)</sup><br>Air Discharge: 15kV<br>Contact Discharge: 8kV                            |
| Radiated Field                    | IEC 61000-4-3<br>Level 3 Criteria A <sup>1)</sup><br>80MHz-1GHz, 10V/M with 1kHz tone / 80% modulation                        |
| Electrical Fast Transient / Burst | IEC 61000-4-4<br>Level 3 Criteria A <sup>1)</sup><br>2kV  |
| Surge                             | IEC 61000-4-5<br>Level 5 Criteria B <sup>2)</sup><br>Common Mode <sup>3)</sup> : 6kV<br>Differential Mode <sup>4)</sup> : 4kV |
| Conducted                         | IEC 61000-4-6<br>Level 3 Criteria A <sup>1)</sup><br>150kHz-80MHz, 10Vrms   |
| Power Frequency Magnetic Fields   | IEC 61000-4-8<br>Level 3 Criteria A <sup>1)</sup><br>10A/Meter  |
| Voltage Dips                      | IEC 61000-4-11<br>100% dip; 0.5 cycle; Self Recoverable<br>70% dip; 10 cycle; Self Recoverable                                |
| Harmonic Current Emission         | IEC/EN 61000-3-2, Class C<br>(115Vac & 230Vac @ ≥ 50% load & 277Vac @ ≥ 75% load)   |
| Voltage Fluctuation and Flicker   | IEC/EN 61000-3-3  |

1) Criteria A: Normal performance within the specification limits

2) Criteria B: Temporary degradation or loss of function which is self-recoverable

3) Asymmetrical: Common mode (Line to earth)

4) Symmetrical: Differential mode (Line to line)

# LED Driver

LNE-185W Series / LNE-□V185W□□□

## Block Diagram

LNE-□V185WA□□

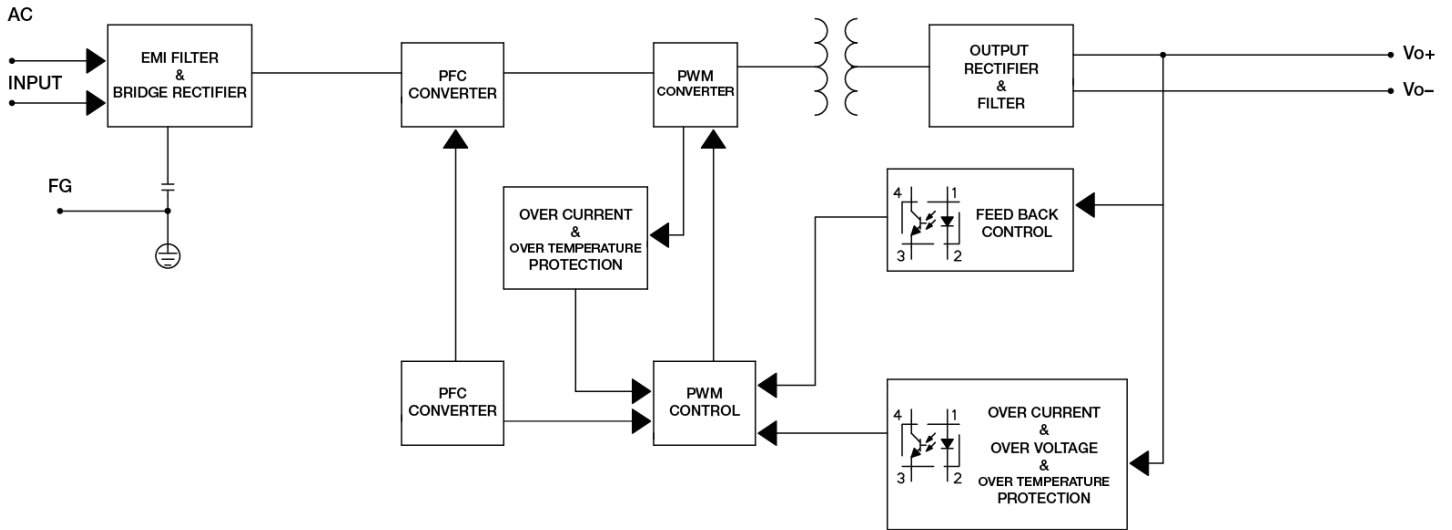

LNE-□V185WD□□

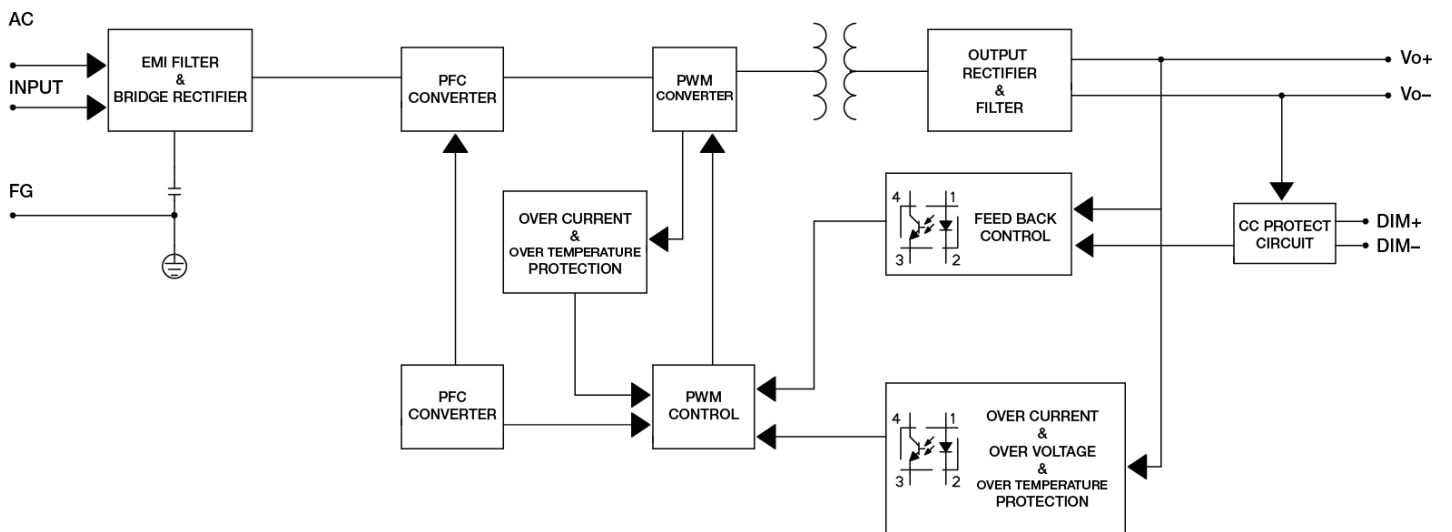



# LED Driver

## LNE-185W Series / LNE-□V185W□□□

### Dimensions

L x W x D: 228 x 68 x 38.8 mm

LNE-□V185WA□□

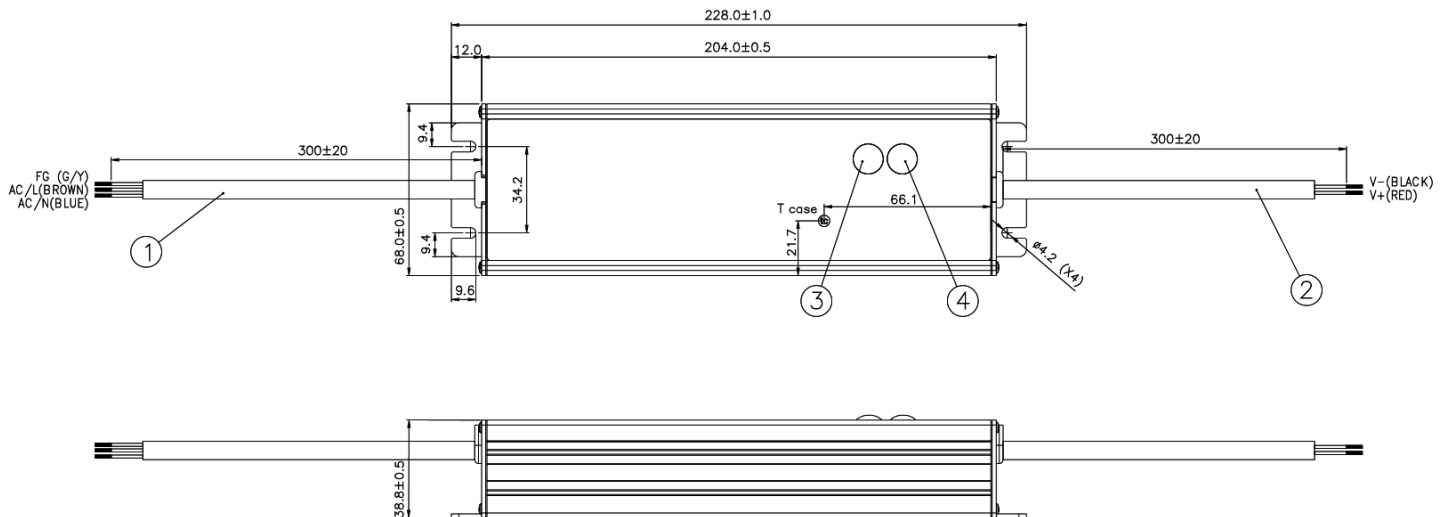

LNE-□V185WD□□

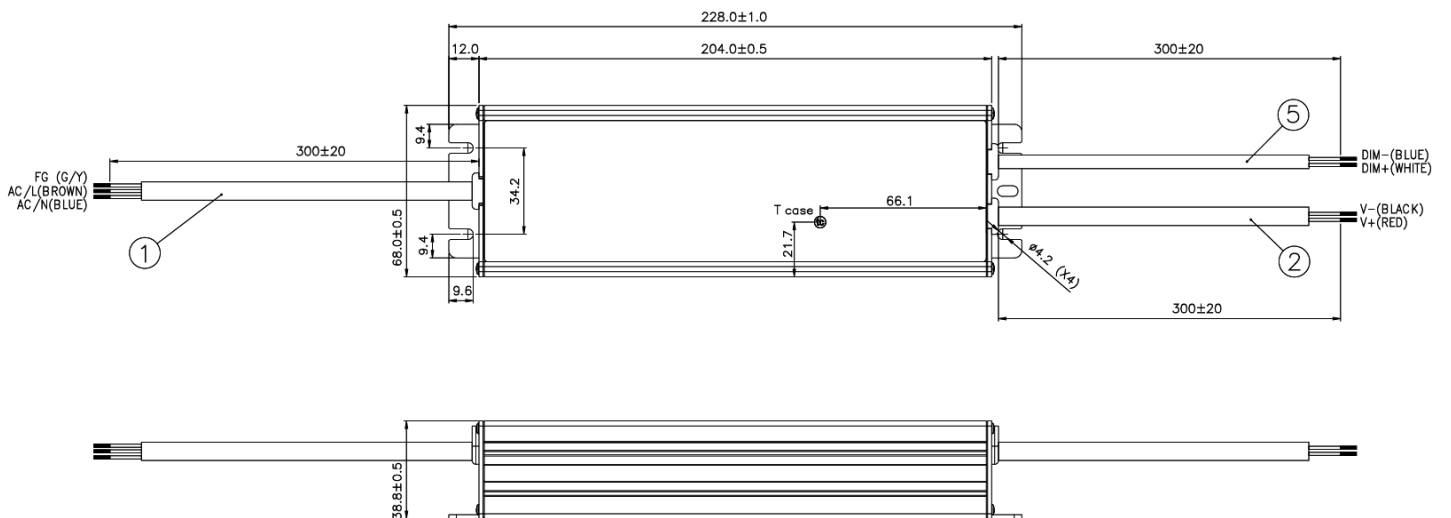

| Item | Device Description                      |
|------|---|
| 1    | Input Cable                             |
| 2    | Output Cable                            |
| 3    | Vo Adjust (Constant Voltage Adjustment) |
| 4    | Io Adjust (Constant Current Adjustment) |
| 5    | Dimming Cable                           |

# LED Driver

LNE-185W Series / LNE-□V185W□□□

## Engineering Data

### De-rating

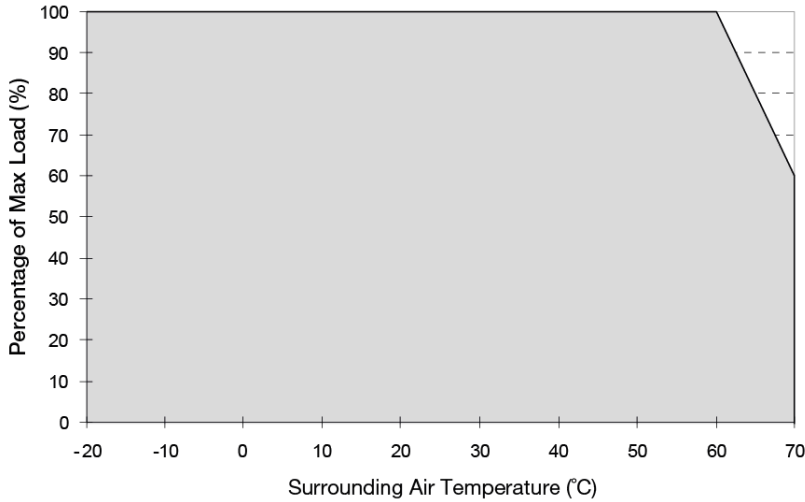
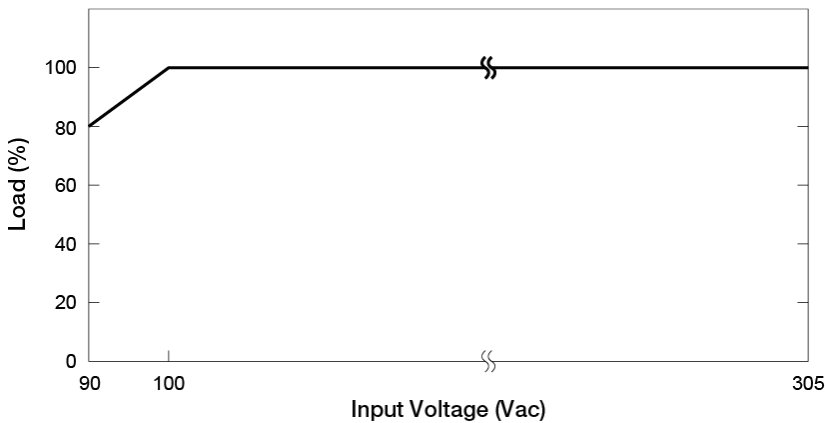

**Fig. 1 De-rating for Horizontal Mounting Orientation**  
 > 60°C de-rate power by 4% / °C

### Note

1. Power supply components may degrade, or be damaged, when the power supply is continuously used outside the shaded region, refer to the graph shown in Fig. 1.
2. If the output capacity is not reduced when the surrounding air temperature >60°C, the device will run into Over Temperature Protection. When activated, the output voltage will go into bouncing mode and will recover when the surrounding air temperature is lowered or the load is reduced as far as necessary to keep the device in working condition.
3. Depending on the surrounding air temperature and output load delivered by the power supply, the device can be very hot!
4. If the device has to be mounted in any other orientation, please do not hesitate to contact [info@deltapsu.com](mailto:info@deltapsu.com) for more details.

### Output De-rating VS. Input Voltage



- No output power de-rating for the input voltage from:-  
 100Vac to 277Vac (LNE-□V185W□C□),  
 100Vac to 305Vac (LNE-□V185W□A□)

# LED Driver

## LNE-185W Series / LNE-□V185W□□□

### Assembly & Installation

The device is not recommended to be placed on low thermal conductive surfaces. For example, plastics.

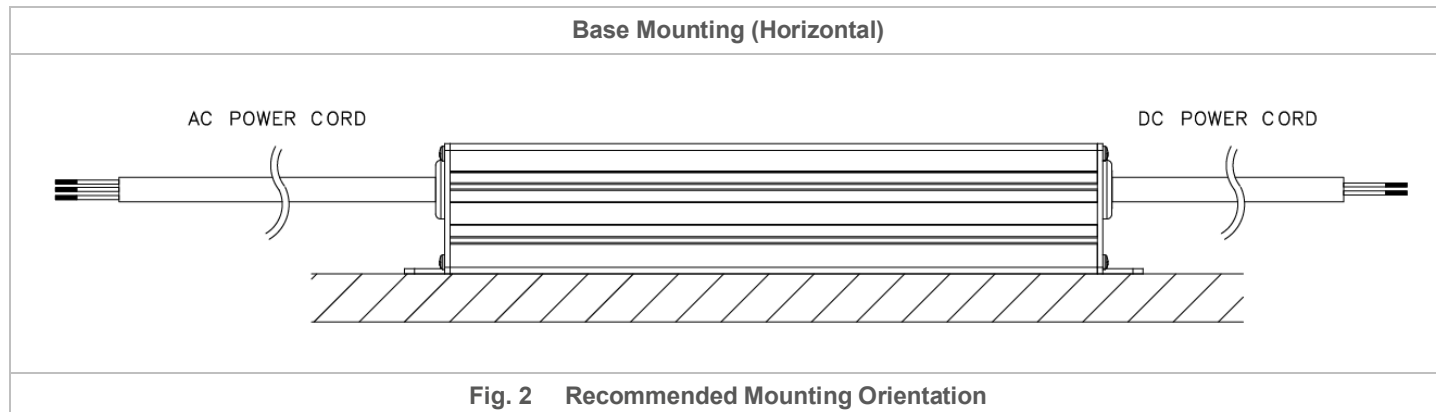

### Safety Instructions

- ALWAYS switch mains of input power OFF before connecting and disconnecting the input voltage to the device. If mains are not turned OFF, there is risk of explosion / severe damage.
- To guarantee sufficient convection cooling, keep a distance of 50mm above and lateral distance to other units.
- DO NOT insert any objects into the device.
- Note that the enclosure of the device can become very hot depending on the surrounding air temperature and load of the device. Risk of burns!
- If the device is continuously operating in a mounting orientation other than those shown in Fig. 2. or at high ambient temperature outside the shaded region shown in Fig. 1., the device may be damaged or degraded.
- When the PE terminal is not connected, the device must be installed on a metal plate with PE connection.
- The current rating for the output cable must be rated higher than or equal to the output current of the power supply. Please refer to the product specifications.
- For device with dimming function, always ensure the dimming control is working properly.

# LED Driver

LNE-185W Series / LNE-□V185W□□□

## Functions

### Start-up Time

The time required for the output voltage to reach 90% of its set value, after the input voltage is applied.

### Rise Time

The time required for the output voltage to change from 10% to 90% of its set value.

### Hold-up Time

Hold up time is the time when the AC input collapses and output voltage retains regulation for a certain period of time. The time required for the output to reach 95% of its set value, after the input voltage is removed.

### ■ Graph illustrating the Start-up Time, Rise Time, and Hold-up Time

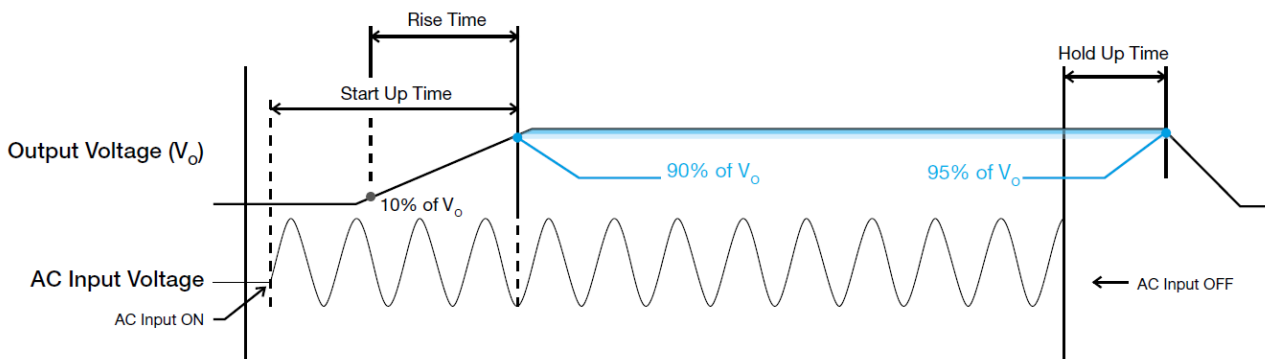

### Inrush Current

Inrush current is the peak, instantaneous, input current measured and, occurs when the input voltage is first applied. For AC input voltages, the maximum peak value of inrush current will occur during the first half cycle of the applied AC voltage. This peak value decreases exponentially during subsequent cycles of AC voltage.

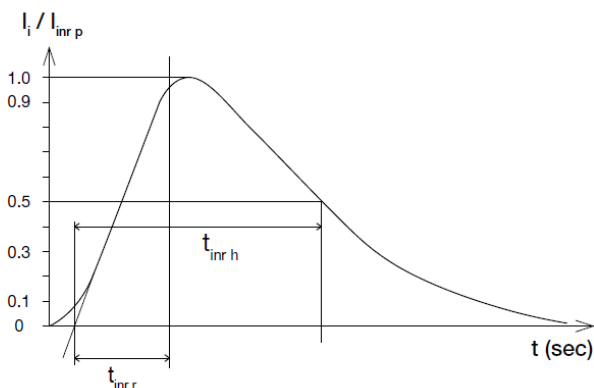

### Dynamic Response

The power supply output voltage will remain within  $\pm 5\%$  of its steady state value, when subjected to a dynamic load from 0 to 100% of its rated current.

#### ■ 90% Duty / 1KHz

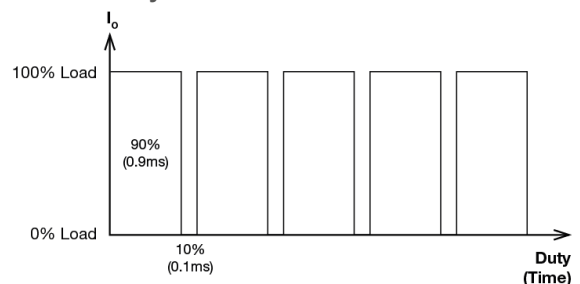

#### ■ 90% Duty / 120Hz

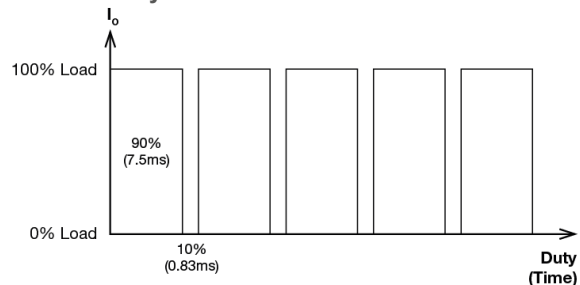

# LED Driver

## LNE-185W Series / LNE-□V185W□□□

### Driving Methods of LED Modules

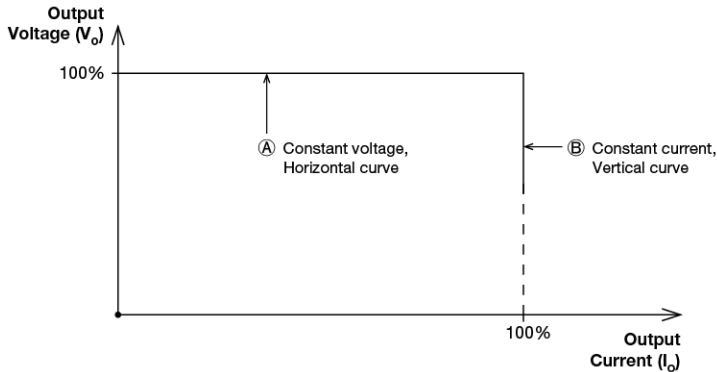

A typical LED power supply is able to either work in "constant voltage mode (CV) or constant current mode (CC)" to drive the LEDs. DELTA's LED driver integrate CV+ CC characteristic that can be operating at both CV mode (with external LED driver, at area **A**) and CC mode (direct drive, at area **B**).

In the constant current region, the highest voltage at the output of the driver depends on the configuration of the end systems.

Should there be any compatibility issues, please contact with Delta.

### Dimming Operations

This operation is available for LNE-□V185WD□□□ only.

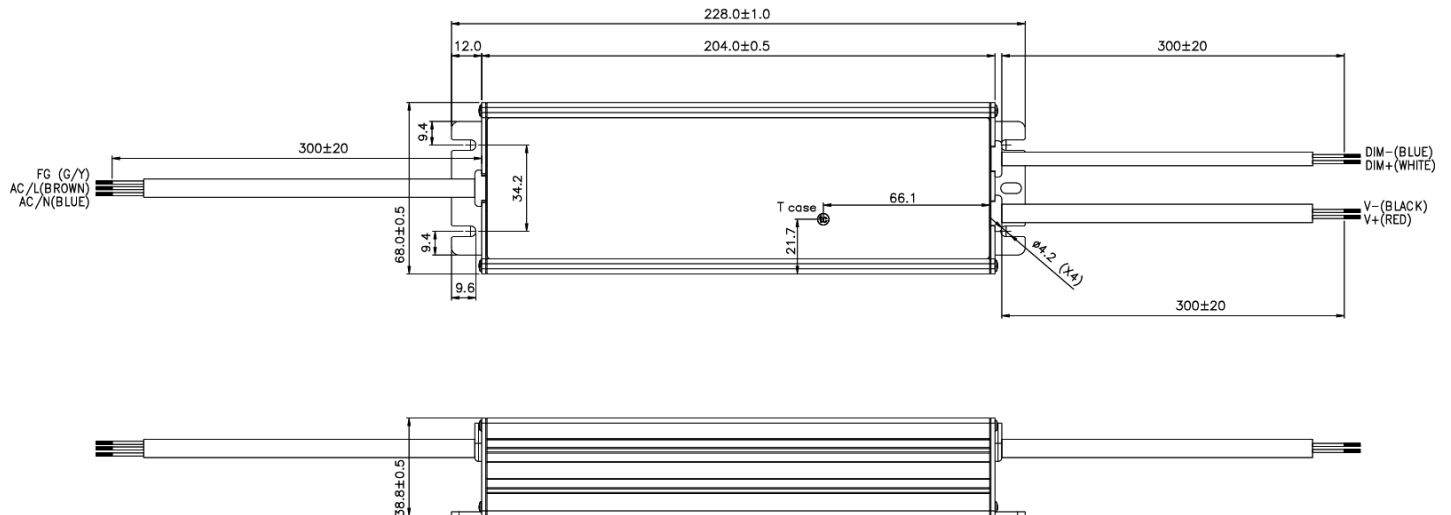

The Dimming connection diagram for turning the lighting fixture ON/OFF can be configured as below.

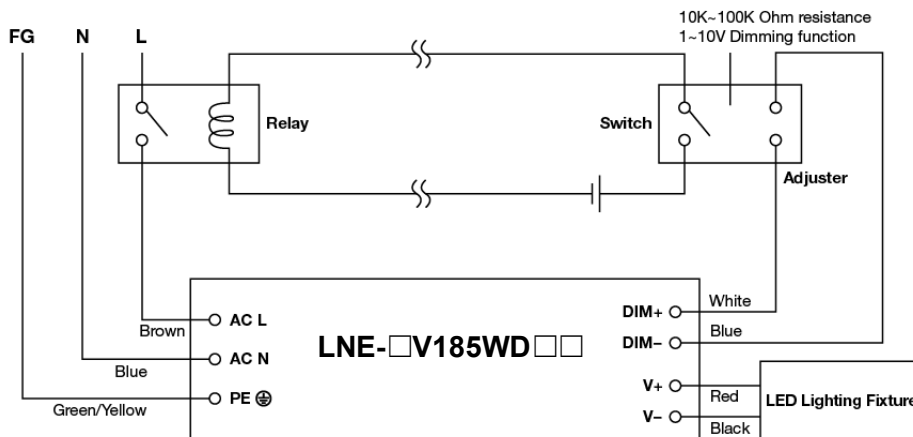

Please refer an example of reference configuration as follows.

1. Built-in 3 in 1 dimming function, IP67 rated. Output constant current level can be adjusted through output cable by connecting a resistance or 1~10Vdc or 10V PWM signal between DIM+ and DIM-.
2. The LED lighting fixture can be turned ON/OFF by the switch.

# LED Driver

## LNE-185W Series / LNE-□V185W□□□

3. Please DO NOT connect "DIM-" to "V-".
4. Reference resistance value for output current adjustment (Typical).

|                   |      |      |      |      |      |      |      |      |      |       |
|-------------------|------|------|------|------|------|------|------|------|------|-------|
| Resistance        | 10KΩ | 20KΩ | 30KΩ | 40KΩ | 50KΩ | 60KΩ | 70KΩ | 80KΩ | 90KΩ | 100KΩ |
| Rated Current (%) | 10%  | 20%  | 30%  | 40%  | 50%  | 60%  | 70%  | 80%  | 90%  | 100%  |

5. 1 ~ 10V dimming function for output current adjustment (Typical).

|                   |     |     |     |     |     |     |     |     |     |      |
|-------------------|-----|-----|-----|-----|-----|-----|-----|-----|-----|------|
| Dimming Value     | 1V  | 2V  | 3V  | 4V  | 5V  | 6V  | 7V  | 8V  | 9V  | 10V  |
| Rated Current (%) | 10% | 20% | 30% | 40% | 50% | 60% | 70% | 80% | 90% | 100% |

6. Please note that LNE-□V185WD□□ can't turn the lighting fixture totally dark. Please refer to the connection method above to achieve 0% brightness of the lighting fixture connecting to the LED power supply unit.
7. It is recommended to directly connect to LEDs, but is not suitable for using additional drivers.

# LED Driver

## LNE-185W Series / LNE-□V185W□□□

### Overload & Overcurrent Protections

Initially, the power supply's Overload (OLP) and Overcurrent (OCP) Protections will be activated when output current between 95% and 108% of  $I_O$  (Max load). In such occurrence, the  $V_O$  will start to droop and once the power supply has reached its maximum power limit, the protection is activated and the power supply will go into "CC mode mode" (Auto-Recovery). The power supply will recover once the fault condition of the OLP and OCP is removed and  $I_O$  is back within the specifications.

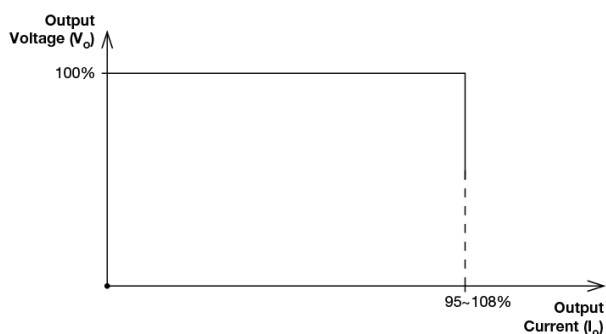

### Short Circuit Protection

The power supply's output OLP/OCP function also provides protection against short circuits. When a short circuit is applied, the output current will operate in "Hiccup mode", as shown in the illustration in the OLP/OCP section on this page. The power supply will return to normal operation after the short circuit is removed.

### Others

#### Delta RoHS Compliant



#### Restriction of the usage of hazardous substances

The European directive 2011/65/EU limits the maximum impurity level of homogeneous materials such as lead, mercury, cadmium, chrome, polybrominated flame retardants PBB and PBDE for the use in electrical and electronic equipment. RoHS is the abbreviation for "Restriction of the use of certain hazardous substances in electrical and electronic equipment".

This product conforms to this standard.

#### PFC – Norm EN 61000-3-2

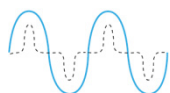

#### Line Current Harmonic content

Typically, the input current waveform is not sinusoidal due to the periodical peak charging of the input capacitor. In industrial environment, complying with EN 61000-3-2 is only necessary under special conditions. Complying to this standard can have some technical drawbacks, such as lower efficiency as well as some commercial aspects such as higher purchasing costs. Frequently, the user does not profit from fulfilling this standard, therefore, it is important to know whether it is mandatory to meet this standard for a specific application.

### Overvoltage Protection

The power supply's overvoltage circuit will be activated when its internal feedback circuit fails. The output voltage shall not exceed its specifications defined on Page 6 under "Protections".

The power supply should be latch.

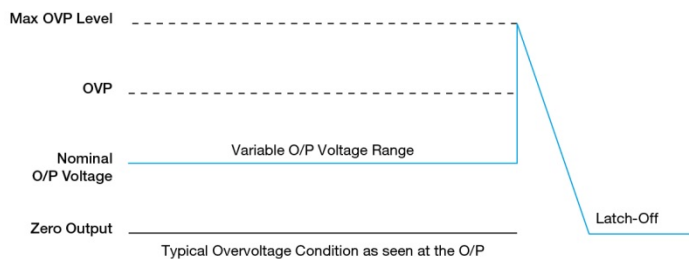

### Over Temperature Protection

As mentioned above, the power supply also has Over Temperature Protection (OTP). In the event of a higher operating temperature at 100% load, the power supply will run into OTP when the operating temperature is beyond what is recommended in the de-rating graph. When activated, the output voltage will go into bouncing mode until the temperature drops to its normal operating temperature as recommended in the de-rating graph.

Компания «Life Electronics» занимается поставками электронных компонентов импортного и отечественного производства от производителей и со складов крупных дистрибьюторов Европы, Америки и Азии.

С конца 2013 года компания активно расширяет линейку поставок компонентов по направлению коаксиальный кабель, кварцевые генераторы и конденсаторы (керамические, пленочные, электролитические), за счёт заключения дистрибьюторских договоров

Мы предлагаем:

- Конкурентоспособные цены и скидки постоянным клиентам.
- Специальные условия для постоянных клиентов.
- Подбор аналогов.
- Поставку компонентов в любых объемах, удовлетворяющих вашим потребностям.
- Приемлемые сроки поставки, возможна ускоренная поставка.
- Доставку товара в любую точку России и стран СНГ.
- Комплексную поставку.
- Работу по проектам и поставку образцов.
- Формирование склада под заказчика.
- Сертификаты соответствия на поставляемую продукцию (по желанию клиента).
- Тестирование поставляемой продукции.
- Поставку компонентов, требующих военную и космическую приемку.
- Входной контроль качества.
- Наличие сертификата ISO.

В составе нашей компании организован Конструкторский отдел, призванный помогать разработчикам, и инженерам.

Конструкторский отдел помогает осуществить:

- Регистрацию проекта у производителя компонентов.
- Техническую поддержку проекта.
- Защиту от снятия компонента с производства.
- Оценку стоимости проекта по компонентам.
- Изготовление тестовой платы монтаж и пусконаладочные работы.



Тел: +7 (812) 336 43 04 (многоканальный)  
Email: [org@lifeelectronics.ru](mailto:org@lifeelectronics.ru)