

Safety relays - PSR-SPP-24DC/MXF3/4X1/2X2/B - 2903258

Please be informed that the data shown in this PDF Document is generated from our Online Catalog. Please find the complete data in the user's documentation. Our General Terms of Use for Downloads are valid (<http://phoenixcontact.com/download>)



Multifunctional safety relay for emergency stop, safety doors, and light grid up to SIL 3, Cat. 4, PL e, automatically or manually monitored activation, 4 N/O contacts, 3 safety functions, 2 shutdown levels, plug-in spring-cage terminal block

Why buy this product

- Up to Cat.4/PL e according to EN ISO 13849-1, SILCL 3 according to EN 62061, SIL 3 according to IEC 61508
- 3 safety functions in one device
- Low housing width of only 22.5mm
- No software configuration required
- Also available with push-in connection



Key Commercial Data

Packing unit	1 STK
GTIN	 4 046356 729826
Weight per Piece (excluding packing)	26.1 g
Weight per piece (including packing)	290.5 g
Country of origin	Germany

Technical data

Note

Utilization restriction	EMC: class A product, see manufacturer's declaration in the download area
-------------------------	---

Dimensions

Width	22.5 mm
Height	117.4 mm
Depth	114.5 mm

Ambient conditions

Safety relays - PSR-SPP-24DC/MXF3/4X1/2X2/B - 2903258

Technical data

Ambient conditions

Ambient temperature (operation)	-20 °C ... 45 °C (see derating curve)
Ambient temperature (storage/transport)	-25 °C ... 85 °C
Max. permissible relative humidity (operation)	75 % (on average, 85% infrequently, non-condensing)
Max. permissible humidity (storage/transport)	75 % (on average, 85% infrequently, non-condensing)
Maximum altitude	≤ 2000 m (Above sea level)

Input data

Nominal input voltage U_N	24 V DC
Input voltage range in reference to U_N	0.85 ... 1.1
Typical input current at U_N	125 mA (with actuated relays)
	55 mA (Two-channel 24 V/0 V + max. 200 mA control (message outputs 32/62) with non-actuated relays)
Current consumption	typ. 5 mA (I_{max}/I_x inputs)
	20 mA (in electric torque)
Voltage at input/start and feedback circuit	24 V -15 %; +10 % (first channel: 24 V; second channel: 0 V)
Typical response time	175 ms (monitored/manual start)
	250 ms (automatic start)
Typ. starting time with U_s	250 ms (when controlled via A1)
Typical release time	25 ms (when controlled via S11/S12 and S21/S22)
	20 ms (when controlled via A1)
Concurrence input 1/2	∞
Recovery time	1 s (Availability time after activation of sensor circuit: 100ms)
Status display	5 green LEDs
Maximum switching frequency	0.5 Hz
Max. permissible overall conductor resistance	100 Ω
Filter time	max. 1.5 ms (Test pulse duration; for all equivalent inputs)
	min. 7.5 ms (Test pulse rate; for all equivalent inputs)

Output data

Contact type	4 enabling current paths
	2 semiconductor alarm outputs
Contact material	AgCuNi, +0,2 -0,4 μm Au
Minimum switching voltage	10 V AC/DC
Maximum switching voltage	250 V AC/DC
Limiting continuous current	6 A (N/O contact)
	max. 100 mA (Alarm output (24 V DC))
Inrush current, minimum	10 mA
Maximum inrush current	6 A
Sq. Total current	$72 A^2 (I_{TH}^2 = I_1^2 + I_2^2 + I_3^2 + I_4^2)$ (note derating))
Interrupting rating (ohmic load) max.	1500 VA (250 V AC, τ = 0 ms)
	66 W (220 V DC, τ = 0 ms)
	66 W (110 V DC, τ = 0 ms)

Safety relays - PSR-SPP-24DC/MXF3/4X1/2X2/B - 2903258

Technical data

Output data

	100 W (48 V DC, $\tau = 0$ ms)
	144 VA (24 V DC, $\tau = 0$ ms)
Maximum interrupting rating (inductive load)	48 W (24 V DC, $\tau = 40$ ms)
	43 W (48 V DC, $\tau = 40$ ms)
Switching capacity min.	0.1 W
Output fuse	6 A gL/gG NEOZED (N/O contact)
	4 A gL/gG NEOZED (for low-demand applications)

General

Relay type	Electromechanical relay with forcibly guided contacts in accordance with EN 50205
Mechanical service life	10 x 10 ⁶ cycles
Net weight	26.1 g
Mounting type	DIN rail mounting
Assembly instructions	See derating curve
Degree of protection	IP20
Min. degree of protection of inst. location	IP54
Mounting position	vertical or horizontal
Control	one and two channel

Connection data

Connection method	Spring-cage connection
pluggable	Yes
Conductor cross section solid min.	0.2 mm ²
Conductor cross section solid max.	1.5 mm ²
Conductor cross section flexible min.	0.2 mm ²
Conductor cross section flexible max.	1.5 mm ²
Conductor cross section AWG min.	24
Conductor cross section AWG max.	16
Stripping length	8 mm
Screw thread	M3

Safety-related characteristic data

Stop category	0
Safety Integrity Level (SIL)	3
	3
Designation	EN ISO 13849
Performance level (PL)	e (5 A DC13; 3 A AC15; 8760 cycles/year)
Category	4
Safety Integrity Level Claim Limit (SIL CL)	3
Designation	IEC 50156
Safety Integrity Level (SIL)	3

Safety relays - PSR-SPP-24DC/MXF3/4X1/2X2/B - 2903258

Technical data

Standards and Regulations

Designation	Air clearances and creepage distances between the power circuits
Standards/regulations	DIN EN 50178/VDE 0160
Rated insulation voltage	250 V AC
Rated surge voltage/insulation	4 kV/basic isolation (safe isolation, reinforced insulation and 6 kV between input circuit, enabling current paths and safety circuit 1 (13/14, 23/24) and safety circuit 2 (43/44, 53/54).)
Degree of pollution	2
Overvoltage category	III

Classifications

eCl@ss

eCl@ss 4.0	27371102
eCl@ss 4.1	27371102
eCl@ss 5.0	27371901
eCl@ss 5.1	27371901
eCl@ss 6.0	27371819
eCl@ss 7.0	27371819
eCl@ss 8.0	27371819
eCl@ss 9.0	27371819

ETIM

ETIM 4.0	EC001449
ETIM 5.0	EC001449

Approvals

Approvals

Approvals

Functional Safety / UL Listed / cUL Listed / EAC / cULus Listed

Ex Approvals

Approvals submitted

Approval details

Functional Safety

Safety relays - PSR-SPP-24DC/MXF3/4X1/2X2/B - 2903258

Approvals

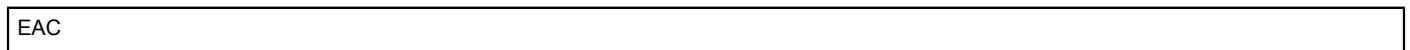
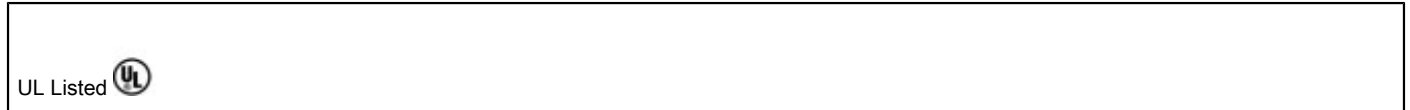

Drawings

Circuit diagram

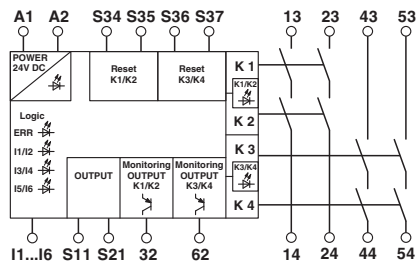

Circuit diagram

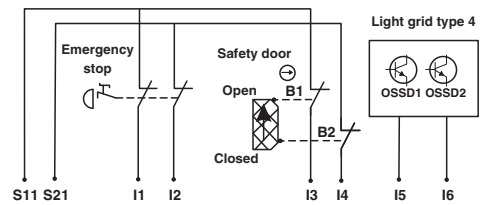

Safety relays - PSR-SPP-24DC/MXF3/4X1/2X2/B - 2903258

Application drawing

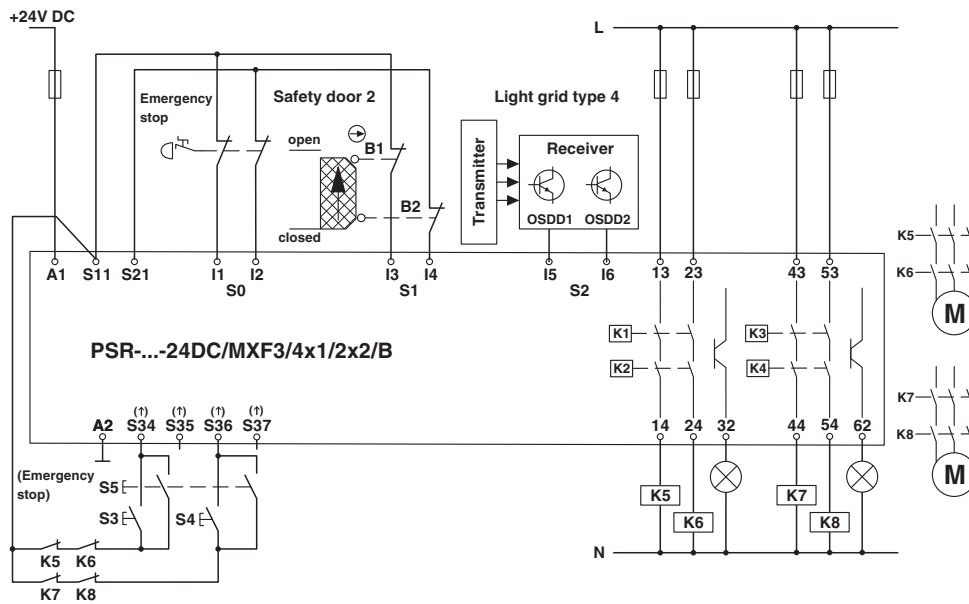

Circuit diagram

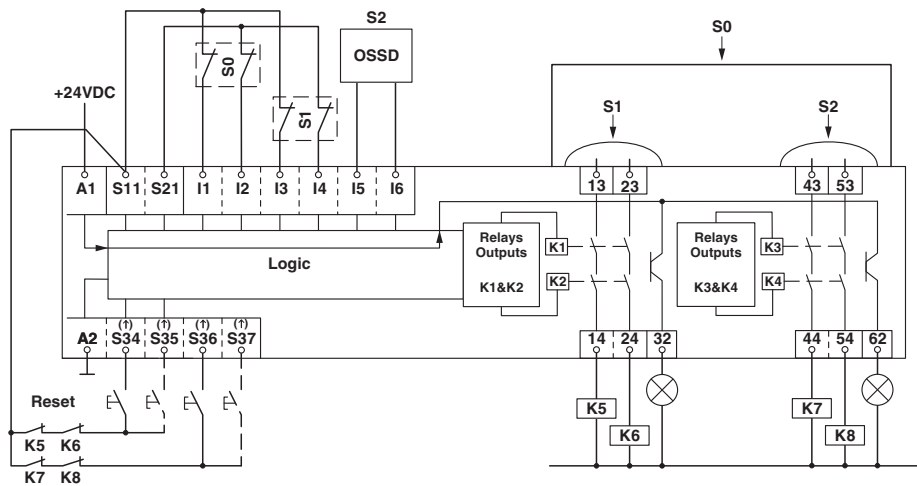

Компания «Life Electronics» занимается поставками электронных компонентов импортного и отечественного производства от производителей и со складов крупных дистрибьюторов Европы, Америки и Азии.

С конца 2013 года компания активно расширяет линейку поставок компонентов по направлению коаксиальный кабель, кварцевые генераторы и конденсаторы (керамические, пленочные, электролитические), за счёт заключения дистрибьюторских договоров

Мы предлагаем:

- Конкурентоспособные цены и скидки постоянным клиентам.
- Специальные условия для постоянных клиентов.
- Подбор аналогов.
- Поставку компонентов в любых объемах, удовлетворяющих вашим потребностям.
- Приемлемые сроки поставки, возможна ускоренная поставка.
- Доставку товара в любую точку России и стран СНГ.
- Комплексную поставку.
- Работу по проектам и поставку образцов.
- Формирование склада под заказчика.
- Сертификаты соответствия на поставляемую продукцию (по желанию клиента).
- Тестирование поставляемой продукции.
- Поставку компонентов, требующих военную и космическую приемку.
- Входной контроль качества.
- Наличие сертификата ISO.

В составе нашей компании организован Конструкторский отдел, призванный помогать разработчикам, и инженерам.

Конструкторский отдел помогает осуществить:

- Регистрацию проекта у производителя компонентов.
- Техническую поддержку проекта.
- Защиту от снятия компонента с производства.
- Оценку стоимости проекта по компонентам.
- Изготовление тестовой платы монтаж и пусконаладочные работы.



Тел: +7 (812) 336 43 04 (многоканальный)

Email: org@lifeelectronics.ru