

POWR-SPEED® Fuse

PSR SERIES HIGH-SPEED SQUARE BODY

Semiconductor Fuses • Flush End • 40 A–2000 A



Description

Littelfuse PSR series high-speed square body fuses are specially designed for protection of power semiconductor devices such as diodes, triacs, IGBTs, SCRs, MOSFETs, and other solid state devices that are typically designed into power conversion and power conditioning equipment. Variable frequency drives, inverters, UPS, rectifiers, and soft-starters are examples of typical equipment designed with sensitive power semiconductor devices that cannot withstand any line surge or overcurrent conditions and require high-speed protection.

Littelfuse POWR-SPEED PSR series products offer optimized circuit protection at the extremely fast speed required to protect modern day power conversion devices. Such products are commonly found in numerous applications including pulp and paper industries, cranes and heavy-lifting equipment, processing industries, wastewater treatment plants, and various large factories and MRO facilities.

Features/Benefits

- Best in class dc performance
- Extremely current limiting
- Superior cycling capability
- Global certification cURus, CCC*
- Direct bus-bar mount design
- Visual and optional microswitch fuse blown indication
- Low watt-loss design
- Compliance with US and Canadian requirements
- Class aR performance according to IEC60269-4

Applications

- Power conversion devices (UPS, inverter, rectifiers, drives)
- Dc systems (dc common bus, dc injection braking)
- Battery protection application (energy storage systems)
- Electric vehicle charging stations
- Heaters and power supplies

Specifications

| | |
|------------------------------|---|
| Voltage Range | Ac: 550 V–1300 V Dc: 500 V–1000 V |
| Amperage Range | 40 A–2000 A |
| Interrupting Range | Ac: 100 kA–200 kA Dc: 150 kA |
| Time Constant | 10 ms at IR |
| Microswitch | Yes |
| Mounting | Flush-end style |
| Material | Body: ceramic Contacts: plated brass |
| Approvals | UL 248-13 Recognized (File: E71611) cURus (File: E71611) CCC* |
| Compliance | UL248-13, IEC 60269-4 (Class aR) |
| Environmental | RoHS Compliant, REACH |
| Operating Temperature | -55 °C to +125 °C |
| Storage Temperature | Up to +35 °C with relative humidity <65 % |
| Country of Origin | Mexico |

Ordering Part Number

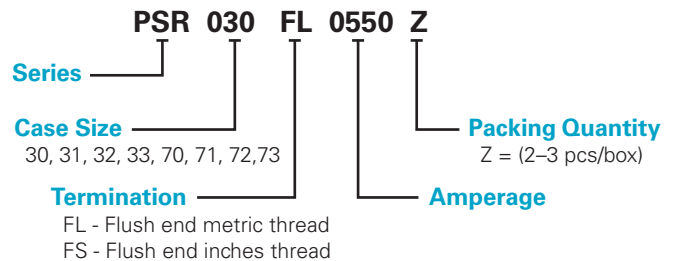

Catalog Number

| SERIES | CASE SIZE | TERMINATION | AMPERAGE | CATALOG NUMBER | ORDERING PART NUMBER |
|--------|-----------|-------------|----------|----------------|----------------------|
| PSR | 030 | FL | 0550 | PSR030FL0550 | PSR030FL0550Z |

Recommended Accessories

Microswitch: MS3H1000C (case size 30 to 33)
MS7H1500C (case size 70 to 73)

Web Resources

Download technical documents: Littelfuse.com/psr

Note: high-speed fuses are designed for fixed installations. They are not intended for use in moving vehicle applications.

*CCC Certification only for Flush End Metric Thread version

POWR-SPEED® Fuse

PSR SERIES HIGH-SPEED SQUARE BODY

Electrical Characteristics

| CASE SIZE | CATALOG NUMBER | | AMPERAGE RATING (A) | VOLTAGE RATING (V) | | | INTERRUPTING RATING | | MELTING (PRE-ARC) I ² T (A ² s) | TOTAL CLEARING I ² T (A ² s) AT RATED VOLTAGE | | WATT LOSS AT 100 % RATED CURRENT (W) | AGENCY CERTIFICATION | |
|--------------|-------------------------|-------------------------|---------------------|--------------------|-----|--------|---------------------|---------|---|---|---------|--------------------------------------|----------------------|------|
| | FLUSH END METRIC THREAD | FLUSH END INCHES THREAD | | AC | | DC | AC | DC | | AC | DC | | cURus | CCC* |
| | | | | IEC | UL | | | | | | | | | |
| 30 | PSR030FL0040 | PSR030FS0040 | 40 | 690 | 700 | 600 | 200 kA | 150 kA | 76 | 280 | 260 | 12 | • | • |
| | PSR030FL0050 | PSR030FS0050 | 50 | 690 | 700 | 600 | 200 kA | 150 kA | 110 | 598 | 384 | 15 | • | • |
| | PSR030FL0063 | PSR030FS0063 | 63 | 690 | 700 | 600 | 200 kA | 150 kA | 176 | 1023 | 640 | 20 | • | • |
| | PSR030FL0080 | PSR030FS0080 | 80 | 690 | 700 | 600 | 200 kA | 150 kA | 304 | 1728 | 1252 | 24 | • | • |
| | PSR030FL0100 | PSR030FS0100 | 100 | 690 | 700 | 600 | 200 kA | 150 kA | 437 | 2835 | 1575 | 27 | • | • |
| | PSR030FL0125 | PSR030FS0125 | 125 | 690 | 700 | 600 | 200 kA | 150 kA | 707 | 4684 | 2783 | 36 | • | • |
| | PSR030FL0160 | PSR030FS0160 | 160 | 690 | 700 | 600 | 200 kA | 150 kA | 1359 | 9114 | 5507 | 39 | • | • |
| | PSR030FL0200 | PSR030FS0200 | 200 | 690 | 700 | 600 | 200 kA | 150 kA | 3012 | 15169 | 14700 | 39 | • | • |
| | PSR030FL0250 | PSR030FS0250 | 250 | 690 | 700 | 600 | 200 kA | 150 kA | 4668 | 29952 | 20833 | 50 | • | • |
| | PSR030FL0315 | PSR030FS0315 | 315 | 690 | 700 | 600 | 200 kA | 150 kA | 7131 | 61830 | 31600 | 61 | • | • |
| | PSR030FL0350 | PSR030FS0350 | 350 | 690 | 700 | 600 | 200 kA | 150 kA | 12007 | 85320 | 49273 | 62 | • | • |
| | PSR030FL0400 | PSR030FS0400 | 400 | 690 | 700 | 600 | 200 kA | 150 kA | 16209 | 114750 | 63367 | 75 | • | • |
| | PSR030FL0450 | PSR030FS0450 | 450 | 690 | 700 | 600 | 200 kA | 150 kA | 23133 | 160110 | 93533 | 75 | • | • |
| PSR030FL0500 | PSR030FS0500 | 500 | 690 | 700 | 600 | 200 kA | 150 kA | 31429 | 225180 | 137333 | 80 | • | • | |
| PSR030FL0550 | PSR030FS0550 | 550 | 690 | 700 | 600 | 200 kA | 150 kA | 44323 | 268920 | 145400 | 78 | • | • | |
| 31 | PSR031FL0200 | PSR031FS0200 | 200 | 690 | 700 | 600 | 200 kA | 150 kA | 1965 | 17334 | 16188 | 49 | • | • |
| | PSR031FL0250 | PSR031FS0250 | 250 | 690 | 700 | 600 | 200 kA | 150 kA | 3789 | 35343 | 21080 | 52 | • | • |
| | PSR031FL0315 | PSR031FS0315 | 315 | 690 | 700 | 600 | 200 kA | 150 kA | 6862 | 59130 | 30694 | 61 | • | • |
| | PSR031FL0350 | PSR031FS0350 | 350 | 690 | 700 | 600 | 200 kA | 150 kA | 9523 | 76140 | 40996 | 63 | • | • |
| | PSR031FL0400 | PSR031FS0400 | 400 | 690 | 700 | 600 | 200 kA | 150 kA | 14770 | 124335 | 64359 | 63 | • | • |
| | PSR031FL0450 | PSR031FS0450 | 450 | 690 | 700 | 600 | 200 kA | 150 kA | 22457 | 178200 | 97444 | 68 | • | • |
| | PSR031FL0500 | PSR031FS0500 | 500 | 690 | 700 | 600 | 200 kA | 150 kA | 29751 | 251505 | 125935 | 74 | • | • |
| | PSR031FL0550 | PSR031FS0550 | 550 | 690 | 700 | 600 | 200 kA | 150 kA | 42056 | 289170 | 171845 | 79 | • | • |
| | PSR031FL0630 | PSR031FS0630 | 630 | 690 | 700 | 600 | 200 kA | 150 kA | 73513 | 507465 | 276315 | 86 | • | • |
| PSR031FL0700 | PSR031FS0700 | 700 | 690 | 700 | 600 | 200 kA | 150 kA | 98187 | 601425 | 337260 | 89 | • | • | |
| PSR031FL0800 | PSR031FS0800 | 800 | 690 | 700 | 600 | 200 kA | 150 kA | 137208 | 848880 | 502800 | 107 | • | • | |
| 32 | PSR032FL0400 | PSR032FS0400 | 400 | 690 | 700 | 600 | 200 kA | 150 kA | 11104 | 79650 | 44533 | 82 | • | • |
| | PSR032FL0450 | PSR032FS0450 | 450 | 690 | 700 | 600 | 200 kA | 150 kA | 15535 | 116100 | 65463 | 88 | • | • |
| | PSR032FL0500 | PSR032FS0500 | 500 | 690 | 700 | 600 | 200 kA | 150 kA | 21573 | 161460 | 88277 | 94 | • | • |
| | PSR032FL0550 | PSR032FS0550 | 550 | 690 | 700 | 600 | 200 kA | 150 kA | 26327 | 177660 | 107960 | 104 | • | • |
| | PSR032FL0630 | PSR032FS0630 | 630 | 690 | 700 | 600 | 200 kA | 150 kA | 34790 | 234900 | 156963 | 110 | • | • |
| | PSR032FL0700 | PSR032FS0700 | 700 | 690 | 700 | 600 | 200 kA | 150 kA | 51191 | 291870 | 209287 | 117 | • | • |
| | PSR032FL0800 | PSR032FS0800 | 800 | 690 | 700 | 600 | 200 kA | 150 kA | 60125 | 472770 | 249000 | 145 | • | • |
| | PSR032FL0900 | PSR032FS0900 | 900 | 690 | 700 | 600 | 200 kA | 150 kA | 107785 | 764100 | 404000 | 145 | • | • |
| | PSR032FL1000 | PSR032FS1000 | 1000 | 690 | 700 | 600 | 200 kA | 150 kA | 190102 | 933120 | 672333 | 146 | • | • |
| PSR032FL1100 | PSR032FS1100 | 1100 | 690 | 700 | 600 | 200 kA | 150 kA | 225379 | 1247400 | 744000 | 149 | • | • | |
| 33 | PSR033FL0450 | PSR033FS0450 | 450 | 690 | 700 | 600 | 200 kA | 150 kA | 13600 | 106380 | 58947 | 99 | • | • |
| | PSR033FL0500 | PSR033FS0500 | 500 | 690 | 700 | 600 | 200 kA | 150 kA | 16434 | 140400 | 77846 | 107 | • | • |
| | PSR033FL0550 | PSR033FS0550 | 550 | 690 | 700 | 600 | 200 kA | 150 kA | 23314 | 187650 | 100461 | 108 | • | • |
| | PSR033FL0630 | PSR033FS0630 | 630 | 690 | 700 | 600 | 200 kA | 150 kA | 38727 | 285930 | 142437 | 113 | • | • |
| | PSR033FL0700 | PSR033FS0700 | 700 | 690 | 700 | 600 | 200 kA | 150 kA | 56763 | 392580 | 209863 | 113 | • | • |
| | PSR033FL0800 | PSR033FS0800 | 800 | 690 | 700 | 600 | 200 kA | 150 kA | 84691 | 575505 | 348500 | 120 | • | • |
| | PSR033FL0900 | PSR033FS0900 | 900 | 690 | 700 | 600 | 200 kA | 150 kA | 122619 | 740340 | 451177 | 122 | • | • |
| | PSR033FL1000 | PSR033FS1000 | 1000 | 690 | 700 | 600 | 200 kA | 150 kA | 222350 | 1170450 | 787750 | 124 | • | • |
| | PSR033FL1100 | PSR033FS1100 | 1100 | 690 | 700 | 600 | 200 kA | 150 kA | 310824 | 1568700 | 821400 | 127 | • | • |
| | PSR033FL1250 | PSR033FS1250 | 1250 | 690 | 700 | 600 | 200 kA | 150 kA | 476902 | 2403000 | 1674333 | 131 | • | • |
| | PSR033FL1400 | PSR033FS1400 | 1400 | 690 | 700 | 500 | 200 kA | 150 kA | 583552 | 2920050 | 1979750 | 144 | • | • |
| | PSR033FL1500 | PSR033FS1500 | 1500 | 600 | 650 | 500 | 200 kA | 150 kA | 674538 | 2433200 | 1996733 | 163 | • | • |
| PSR033FL1600 | PSR033FS1600 | 1600 | 600 | 650 | 500 | 200 kA | 150 kA | 779948 | 2942800 | 2301633 | 182 | • | • | |
| PSR033FL1800 | PSR033FS1800 | 1800 | 600 | 650 | 500 | 200 kA | 150 kA | 952196 | 3785040 | 2724180 | 224 | • | • | |
| PSR033FL2000 | PSR033FS2000 | 2000 | 550 | 600 | 500 | 200 kA | 150 kA | 1234315 | 4131600 | 3755180 | 222 | • | • | |

*CCC Certification only on Flush End Metric Thread Version

POWR-SPEED® Fuse

PSR SERIES HIGH-SPEED SQUARE BODY

Electrical Characteristics (cont.)

| CASE SIZE | CATALOG NUMBER | | AMPERAGE RATING (A) | VOLTAGE RATING (V) | | | INTERRUPTING RATING | | MELTING (PRE-ARC) I ² T (A ² s) | TOTAL CLEARING I ² T (A ² s) AT RATED VOLTAGE | | WATT LOSS AT 100 % RATED CURRENT (W) | AGENCY CERTIFICATION | |
|--------------|-------------------------|-------------------------|---------------------|--------------------|------|--------|---------------------|--------|---|---|--------|--------------------------------------|----------------------|------|
| | FLUSH END METRIC THREAD | FLUSH END INCHES THREAD | | AC | | DC | AC | DC | | AC | DC | | cURus | CCC* |
| | | | | IEC | UL | | | | | | | | | |
| 70 | PSR070FL0050 | PSR070FS0050 | 50 | 1250 | 1300 | 1000 | 100 kA | 150 kA | 177 | 2050 | 400 | 21 | • | • |
| | PSR070FL0063 | PSR070FS0063 | 63 | 1250 | 1300 | 1000 | 100 kA | 150 kA | 273 | 3399 | 900 | 23 | • | • |
| | PSR070FL0080 | PSR070FS0080 | 80 | 1250 | 1300 | 1000 | 100 kA | 150 kA | 583 | 6732 | 2200 | 24 | • | • |
| | PSR070FL0100 | PSR070FS0100 | 100 | 1250 | 1300 | 1000 | 100 kA | 150 kA | 974 | 10996 | 3750 | 29 | • | • |
| | PSR070FL0125 | PSR070FS0125 | 125 | 1250 | 1300 | 1000 | 100 kA | 150 kA | 1352 | 13011 | 5150 | 43 | • | • |
| | PSR070FL0160 | PSR070FS0160 | 160 | 1250 | 1300 | 1000 | 100 kA | 150 kA | 2377 | 25662 | 8950 | 51 | • | • |
| | PSR070FL0200 | PSR070FS0200 | 200 | 1250 | 1300 | 1000 | 100 kA | 150 kA | 4177 | 39087 | 17267 | 61 | • | • |
| | PSR070FL0250 | PSR070FS0250 | 250 | 1250 | 1300 | 1000 | 100 kA | 150 kA | 8629 | 89790 | 36750 | 71 | • | • |
| | PSR070FL0280 | PSR070FS0280 | 280 | 1250 | 1300 | 1000 | 100 kA | 150 kA | 11844 | 113201 | 46750 | 71 | • | • |
| PSR070FL0315 | PSR070FS0315 | 315 | 1250 | 1300 | 1000 | 100 kA | 150 kA | 18162 | 142051 | 66833 | 69 | • | • | |
| 71 | PSR071FL0160 | PSR071FS0160 | 160 | 1250 | 1300 | 1000 | 100 kA | 150 kA | 2756 | 24600 | 8800 | 42 | • | • |
| | PSR071FL0200 | PSR071FS0200 | 200 | 1250 | 1300 | 1000 | 100 kA | 150 kA | 4918 | 50307 | 19050 | 52 | • | • |
| | PSR071FL0250 | PSR071FS0250 | 250 | 1250 | 1300 | 1000 | 100 kA | 150 kA | 10592 | 104427 | 43100 | 54 | • | • |
| | PSR071FL0280 | PSR071FS0280 | 280 | 1250 | 1300 | 1000 | 100 kA | 150 kA | 13763 | 131897 | 54150 | 58 | • | • |
| | PSR071FL0315 | PSR071FS0315 | 315 | 1250 | 1300 | 1000 | 100 kA | 150 kA | 20882 | 200244 | 67450 | 60 | • | • |
| | PSR071FL0350 | PSR071FS0350 | 350 | 1250 | 1300 | 1000 | 100 kA | 150 kA | 23301 | 225500 | 102500 | 71 | • | • |
| | PSR071FL0400 | PSR071FS0400 | 400 | 1250 | 1300 | 1000 | 100 kA | 150 kA | 43211 | 374986 | 185000 | 69 | • | • |
| PSR071FL0450 | PSR071FS0450 | 450 | 1250 | 1300 | 1000 | 100 kA | 150 kA | 55915 | 452394 | 241333 | 88 | • | • | |
| 72 | PSR072FL0250 | PSR072FS0250 | 250 | 1250 | 1300 | 1000 | 100 kA | 150 kA | 7737 | 72789 | 28567 | 63 | • | • |
| | PSR072FL0280 | PSR072FS0280 | 280 | 1250 | 1300 | 1000 | 100 kA | 150 kA | 10915 | 124538 | 46897 | 62 | • | • |
| | PSR072FL0315 | PSR072FS0315 | 315 | 1250 | 1300 | 1000 | 100 kA | 150 kA | 16187 | 145140 | 58867 | 67 | • | • |
| | PSR072FL0350 | PSR072FS0350 | 350 | 1250 | 1300 | 1000 | 100 kA | 150 kA | 18727 | 160447 | 69633 | 80 | • | • |
| | PSR072FL0400 | PSR072FS0400 | 400 | 1250 | 1300 | 1000 | 100 kA | 150 kA | 27112 | 243540 | 108000 | 89 | • | • |
| | PSR072FL0450 | PSR072FS0450 | 450 | 1250 | 1300 | 1000 | 100 kA | 150 kA | 35927 | 406413 | 159133 | 107 | • | • |
| | PSR072FL0500 | PSR072FS0500 | 500 | 1250 | 1300 | 1000 | 100 kA | 150 kA | 50398 | 425375 | 216333 | 115 | • | • |
| | PSR072FL0550 | PSR072FS0550 | 550 | 1250 | 1300 | 1000 | 100 kA | 150 kA | 73858 | 539833 | 271333 | 115 | • | • |
| PSR072FL0630 | PSR072FS0630 | 630 | 1250 | 1300 | 1000 | 100 kA | 150 kA | 126126 | 942180 | 436000 | 119 | • | • | |
| 73 | PSR073FL0315 | PSR073FS0315 | 315 | 1250 | 1300 | 1000 | 100 kA | 150 kA | 10245 | 106600 | 38650 | 88 | • | • |
| | PSR073FL0350 | PSR073FS0350 | 350 | 1250 | 1300 | 1000 | 100 kA | 150 kA | 13586 | 159627 | 57467 | 96 | • | • |
| | PSR073FL0400 | PSR073FS0400 | 400 | 1250 | 1300 | 1000 | 100 kA | 150 kA | 19797 | 211273 | 86800 | 124 | • | • |
| | PSR073FL0450 | PSR073FS0450 | 450 | 1250 | 1300 | 1000 | 100 kA | 150 kA | 29834 | 279073 | 114333 | 122 | • | • |
| | PSR073FL0500 | PSR073FS0500 | 500 | 1250 | 1300 | 1000 | 100 kA | 150 kA | 42751 | 416437 | 184500 | 121 | • | • |
| | PSR073FL0550 | PSR073FS0550 | 550 | 1250 | 1300 | 1000 | 100 kA | 150 kA | 55513 | 491713 | 224500 | 130 | • | • |
| | PSR073FL0630 | PSR073FS0630 | 630 | 1250 | 1300 | 1000 | 100 kA | 150 kA | 94649 | 804338 | 377500 | 136 | • | • |
| PSR073FL0700 | PSR073FS0700 | 700 | 1250 | 1300 | 1000 | 100 kA | 150 kA | 158097 | 1170960 | 575667 | 135 | • | • | |

*CCC Certification only on Flush End Metric Thread Version

POWR-SPEED® Fuse

PSR SERIES HIGH-SPEED SQUARE BODY

Ordering Information

| CASE SIZE | FLUSH END - METRIC THREAD | | | FLUSH END - INCHES THREAD | | | BOX QUANTITY PCS/BOX |
|--------------|---------------------------|----------------------|--------------|---------------------------|----------------------|-------------|----------------------|
| | CATALOG NUMBER | ORDERING PART NUMBER | UPC | CATALOG NUMBER | ORDERING PART NUMBER | UPC | |
| 30 | PSR030FL0040 | PSR030FL0040Z | 07945820436 | PSR030FS0040 | PSR030FS0040Z | 07945820451 | 3 pcs/box |
| | PSR030FL0050 | PSR030FL0050Z | 07945820437 | PSR030FS0050 | PSR030FS0050Z | 07945820452 | 3 pcs/box |
| | PSR030FL0063 | PSR030FL0063Z | 07945820438 | PSR030FS0063 | PSR030FS0063Z | 07945820453 | 3 pcs/box |
| | PSR030FL0080 | PSR030FL0080Z | 07945820439 | PSR030FS0080 | PSR030FS0080Z | 07945820454 | 3 pcs/box |
| | PSR030FL0100 | PSR030FL0100Z | 07945820440 | PSR030FS0100 | PSR030FS0100Z | 07945820455 | 3 pcs/box |
| | PSR030FL0125 | PSR030FL0125Z | 07945820441 | PSR030FS0125 | PSR030FS0125Z | 07945820456 | 3 pcs/box |
| | PSR030FL0160 | PSR030FL0160Z | 07945820442 | PSR030FS0160 | PSR030FS0160Z | 07945820457 | 3 pcs/box |
| | PSR030FL0200 | PSR030FL0200Z | 07945820443 | PSR030FS0200 | PSR030FS0200Z | 07945820458 | 3 pcs/box |
| | PSR030FL0250 | PSR030FL0250Z | 07945820444 | PSR030FS0250 | PSR030FS0250Z | 07945820459 | 3 pcs/box |
| | PSR030FL0315 | PSR030FL0315Z | 07945820445 | PSR030FS0315 | PSR030FS0315Z | 07945820460 | 3 pcs/box |
| | PSR030FL0350 | PSR030FL0350Z | 07945820446 | PSR030FS0350 | PSR030FS0350Z | 07945820461 | 3 pcs/box |
| | PSR030FL0400 | PSR030FL0400Z | 07945820447 | PSR030FS0400 | PSR030FS0400Z | 07945820462 | 3 pcs/box |
| | PSR030FL0450 | PSR030FL0450Z | 07945820448 | PSR030FS0450 | PSR030FS0450Z | 07945820463 | 3 pcs/box |
| | PSR030FL0500 | PSR030FL0500Z | 07945820449 | PSR030FS0500 | PSR030FS0500Z | 07945820464 | 3 pcs/box |
| PSR030FL0550 | PSR030FL0550Z | 07945820450 | PSR030FS0550 | PSR030FS0550Z | 07945820465 | 3 pcs/box | |
| 31 | PSR031FL0200 | PSR031FL0200Z | 07945820466 | PSR031FS0200 | PSR031FS0200Z | 07945820477 | 3 pcs/box |
| | PSR031FL0250 | PSR031FL0250Z | 07945820467 | PSR031FS0250 | PSR031FS0250Z | 07945820478 | 3 pcs/box |
| | PSR031FL0315 | PSR031FL0315Z | 07945820468 | PSR031FS0315 | PSR031FS0315Z | 07945820479 | 3 pcs/box |
| | PSR031FL0350 | PSR031FL0350Z | 07945820469 | PSR031FS0350 | PSR031FS0350Z | 07945820480 | 3 pcs/box |
| | PSR031FL0400 | PSR031FL0400Z | 07945820470 | PSR031FS0400 | PSR031FS0400Z | 07945820481 | 3 pcs/box |
| | PSR031FL0450 | PSR031FL0450Z | 07945820471 | PSR031FS0450 | PSR031FS0450Z | 07945820482 | 3 pcs/box |
| | PSR031FL0500 | PSR031FL0500Z | 07945820472 | PSR031FS0500 | PSR031FS0500Z | 07945820483 | 3 pcs/box |
| | PSR031FL0550 | PSR031FL0550Z | 07945820473 | PSR031FS0550 | PSR031FS0550Z | 07945820484 | 3 pcs/box |
| | PSR031FL0630 | PSR031FL0630Z | 07945820474 | PSR031FS0630 | PSR031FS0630Z | 07945820485 | 3 pcs/box |
| | PSR031FL0700 | PSR031FL0700Z | 07945820475 | PSR031FS0700 | PSR031FS0700Z | 07945820486 | 3 pcs/box |
| PSR031FL0800 | PSR031FL0800Z | 07945820476 | PSR031FS0800 | PSR031FS0800Z | 07945820487 | 3 pcs/box | |
| 32 | PSR032FL0400 | PSR032FL0400Z | 07945820488 | PSR032FS0400 | PSR032FS0400Z | 07945820498 | 3 pcs/box |
| | PSR032FL0450 | PSR032FL0450Z | 07945820489 | PSR032FS0450 | PSR032FS0450Z | 07945820499 | 3 pcs/box |
| | PSR032FL0500 | PSR032FL0500Z | 07945820490 | PSR032FS0500 | PSR032FS0500Z | 07945820500 | 3 pcs/box |
| | PSR032FL0550 | PSR032FL0550Z | 07945820491 | PSR032FS0550 | PSR032FS0550Z | 07945820501 | 3 pcs/box |
| | PSR032FL0630 | PSR032FL0630Z | 07945820492 | PSR032FS0630 | PSR032FS0630Z | 07945820502 | 3 pcs/box |
| | PSR032FL0700 | PSR032FL0700Z | 07945820493 | PSR032FS0700 | PSR032FS0700Z | 07945820503 | 3 pcs/box |
| | PSR032FL0800 | PSR032FL0800Z | 07945820494 | PSR032FS0800 | PSR032FS0800Z | 07945820504 | 3 pcs/box |
| | PSR032FL0900 | PSR032FL0900Z | 07945820495 | PSR032FS0900 | PSR032FS0900Z | 07945820505 | 3 pcs/box |
| | PSR032FL1000 | PSR032FL1000Z | 07945820496 | PSR032FS1000 | PSR032FS1000Z | 07945820506 | 3 pcs/box |
| | PSR032FL1100 | PSR032FL1100Z | 07945820497 | PSR032FS1100 | PSR032FS1100Z | 07945820507 | 3 pcs/box |
| 33 | PSR033FL0450 | PSR033FL0450Z | 07945822163 | PSR033FS0450 | PSR033FS0450Z | 07945822164 | 3 pcs/box |
| | PSR033FL0500 | PSR033FL0500Z | 07945820508 | PSR033FS0500 | PSR033FS0500Z | 07945820522 | 3 pcs/box |
| | PSR033FL0550 | PSR033FL0550Z | 07945820509 | PSR033FS0550 | PSR033FS0550Z | 07945820523 | 3 pcs/box |
| | PSR033FL0630 | PSR033FL0630Z | 07945820510 | PSR033FS0630 | PSR033FS0630Z | 07945820524 | 3 pcs/box |
| | PSR033FL0700 | PSR033FL0700Z | 07945820511 | PSR033FS0700 | PSR033FS0700Z | 07945820525 | 3 pcs/box |
| | PSR033FL0800 | PSR033FL0800Z | 07945820512 | PSR033FS0800 | PSR033FS0800Z | 07945820526 | 3 pcs/box |
| | PSR033FL0900 | PSR033FL0900Z | 07945820513 | PSR033FS0900 | PSR033FS0900Z | 07945820527 | 3 pcs/box |
| | PSR033FL1000 | PSR033FL1000Z | 07945820514 | PSR033FS1000 | PSR033FS1000Z | 07945820528 | 3 pcs/box |
| | PSR033FL1100 | PSR033FL1100Z | 07945820515 | PSR033FS1100 | PSR033FS1100Z | 07945820529 | 3 pcs/box |
| | PSR033FL1250 | PSR033FL1250Z | 07945820516 | PSR033FS1250 | PSR033FS1250Z | 07945820530 | 3 pcs/box |
| | PSR033FL1400 | PSR033FL1400Z | 07945820517 | PSR033FS1400 | PSR033FS1400Z | 07945820531 | 3 pcs/box |
| | PSR033FL1500 | PSR033FL1500Z | 07945820518 | PSR033FS1500 | PSR033FS1500Z | 07945820532 | 3 pcs/box |
| | PSR033FL1600 | PSR033FL1600Z | 07945820519 | PSR033FS1600 | PSR033FS1600Z | 07945820533 | 3 pcs/box |
| | PSR033FL1800 | PSR033FL1800Z | 07945820520 | PSR033FS1800 | PSR033FS1800Z | 07945820534 | 3 pcs/box |
| PSR033FL2000 | PSR033FL2000Z | 07945820521 | PSR033FS2000 | PSR033FS2000Z | 07945820535 | 3 pcs/box | |

POWR-SPEED® Fuse

PSR SERIES HIGH-SPEED SQUARE BODY

Ordering Information (cont.)

| CASE SIZE | FLUSH END - METRIC THREAD | | | FLUSH END - INCHES THREAD | | | BOX QUANTITY PCS/BOX |
|--------------|---------------------------|----------------------|--------------|---------------------------|----------------------|-------------|----------------------|
| | CATALOG NUMBER | ORDERING PART NUMBER | UPC | CATALOG NUMBER | ORDERING PART NUMBER | UPC | |
| 70 | PSR070FL0050 | PSR070FL0050Z | 07945820536 | PSR070FS0050 | PSR070FS0050Z | 07945820546 | 2 pcs/box |
| | PSR070FL0063 | PSR070FL0063Z | 07945820537 | PSR070FS0063 | PSR070FS0063Z | 07945820547 | 2 pcs/box |
| | PSR070FL0080 | PSR070FL0080Z | 07945820538 | PSR070FS0080 | PSR070FS0080Z | 07945820548 | 2 pcs/box |
| | PSR070FL0100 | PSR070FL0100Z | 07945820539 | PSR070FS0100 | PSR070FS0100Z | 07945820549 | 2 pcs/box |
| | PSR070FL0125 | PSR070FL0125Z | 07945820540 | PSR070FS0125 | PSR070FS0125Z | 07945820550 | 2 pcs/box |
| | PSR070FL0160 | PSR070FL0160Z | 07945820541 | PSR070FS0160 | PSR070FS0160Z | 07945820551 | 2 pcs/box |
| | PSR070FL0200 | PSR070FL0200Z | 07945820542 | PSR070FS0200 | PSR070FS0200Z | 07945820552 | 2 pcs/box |
| | PSR070FL0250 | PSR070FL0250Z | 07945820543 | PSR070FS0250 | PSR070FS0250Z | 07945820553 | 2 pcs/box |
| | PSR070FL0280 | PSR070FL0280Z | 07945820544 | PSR070FS0280 | PSR070FS0280Z | 07945820554 | 2 pcs/box |
| | PSR070FL0315 | PSR070FL0315Z | 07945820545 | PSR070FS0315 | PSR070FS0315Z | 07945820555 | 2 pcs/box |
| 71 | PSR071FL0160 | PSR071FL0160Z | 07945820556 | PSR071FS0160 | PSR071FS0160Z | 07945820564 | 2 pcs/box |
| | PSR071FL0200 | PSR071FL0200Z | 07945820557 | PSR071FS0200 | PSR071FS0200Z | 07945820565 | 2 pcs/box |
| | PSR071FL0250 | PSR071FL0250Z | 07945820558 | PSR071FS0250 | PSR071FS0250Z | 07945820566 | 2 pcs/box |
| | PSR071FL0280 | PSR071FL0280Z | 07945820573 | PSR071FS0280 | PSR071FS0280Z | 07945820582 | 2 pcs/box |
| | PSR071FL0315 | PSR071FL0315Z | 07945820560 | PSR071FS0315 | PSR071FS0315Z | 07945820568 | 2 pcs/box |
| | PSR071FL0350 | PSR071FL0350Z | 07945820561 | PSR071FS0350 | PSR071FS0350Z | 07945820569 | 2 pcs/box |
| | PSR071FL0400 | PSR071FL0400Z | 07945820562 | PSR071FS0400 | PSR071FS0400Z | 07945820570 | 2 pcs/box |
| | PSR071FL0450 | PSR071FL0450Z | 07945820563 | PSR071FS0450 | PSR071FS0450Z | 07945820571 | 2 pcs/box |
| 72 | PSR072FL0250 | PSR072FL0250Z | 07945820572 | PSR072FS0250 | PSR072FS0250Z | 07945820581 | 2 pcs/box |
| | PSR072FL0280 | PSR072FL0280Z | 07945820573 | PSR072FS0280 | PSR072FS0280Z | 07945820582 | 2 pcs/box |
| | PSR072FL0315 | PSR072FL0315Z | 07945820574 | PSR072FS0315 | PSR072FS0315Z | 07945820583 | 2 pcs/box |
| | PSR072FL0350 | PSR072FL0350Z | 07945820575 | PSR072FS0350 | PSR072FS0350Z | 07945820584 | 2 pcs/box |
| | PSR072FL0400 | PSR072FL0400Z | 07945820576 | PSR072FS0400 | PSR072FS0400Z | 07945820585 | 2 pcs/box |
| | PSR072FL0450 | PSR072FL0450Z | 07945820577 | PSR072FS0450 | PSR072FS0450Z | 07945820586 | 2 pcs/box |
| | PSR072FL0500 | PSR072FL0500Z | 07945820578 | PSR072FS0500 | PSR072FS0500Z | 07945820587 | 2 pcs/box |
| | PSR072FL0550 | PSR072FL0550Z | 07945820579 | PSR072FS0550 | PSR072FS0550Z | 07945820588 | 2 pcs/box |
| 73 | PSR073FL0630 | PSR072FL0630Z | 07945820580 | PSR072FS0630 | PSR072FS0630Z | 07945820589 | 2 pcs/box |
| | PSR073FL0315 | PSR073FL0315Z | 07945820590 | PSR073FS0315 | PSR073FS0315Z | 07945820602 | 2 pcs/box |
| | PSR073FL0350 | PSR073FL0350Z | 07945820591 | PSR073FS0350 | PSR073FS0350Z | 07945820603 | 2 pcs/box |
| | PSR073FL0400 | PSR073FL0400Z | 07945820592 | PSR073FS0400 | PSR073FS0400Z | 07945820604 | 2 pcs/box |
| | PSR073FL0450 | PSR073FL0450Z | 07945820593 | PSR073FS0450 | PSR073FS0450Z | 07945820605 | 2 pcs/box |
| | PSR073FL0500 | PSR073FL0500Z | 07945820594 | PSR073FS0500 | PSR073FS0500Z | 07945820606 | 2 pcs/box |
| | PSR073FL0550 | PSR073FL0550Z | 07945820595 | PSR073FS0550 | PSR073FS0550Z | 07945820607 | 2 pcs/box |
| | PSR073FL0630 | PSR073FL0630Z | 07945820596 | PSR073FS0630 | PSR073FS0630Z | 07945820608 | 2 pcs/box |
| PSR073FL0700 | PSR073FL0700Z | 07945820597 | PSR073FS0700 | PSR073FS0700Z | 07945820609 | 2 pcs/box | |

POWR-SPEED® Fuse

PSR SERIES HIGH-SPEED SQUARE BODY

Dimensions



DIMENSIONS IN MM (IN)

| CASE SIZE | A | B | C | D | E | F | G | FL METRIC THREAD | FS INCHES THREAD | RECOMMENDED TORQUE |
|-----------|-------------|-------------|-------------|-------------|-------------|-------------|--------------|------------------|------------------|--------------------|
| 30 | 50.0 (1.97) | 43.0 (1.69) | 43.0 (1.69) | 49.0 (1.93) | 17.0 (0.67) | 47.4 (1.86) | 76.4 (3.01) | M8 x 1.25 | 5/16"–18 UNC 2B | 13–20 Nm |
| 31 | 50.0 (1.97) | 51.5 (2.03) | 51.5 (2.03) | 57.5 (2.26) | 20.0 (0.8) | 48.2 (1.90) | 84.9 (3.34) | M8 x 1.25 | 5/16"–18 UNC 2B | 13–20 Nm |
| 32 | 51.0 (2.01) | 60.0 (2.36) | 60.0 (2.36) | 66.0 (2.60) | 23.0 (0.91) | 48.8 (1.92) | 93.4 (3.68) | M10 x 1.5 | 3/8"–16 UNC 2B | 26–35 Nm |
| 33 | 51.0 (2.01) | 73.5 (2.89) | 73.5 (2.89) | 79.5 (3.13) | 30.0 (1.18) | 49.2 (1.94) | 106.9 (4.21) | M12 x 1.75 | 1/2"–13 UNC 2B | 45–55 Nm |
| 70 | 74.0 (2.91) | 43.0 (1.69) | 43.0 (1.69) | 49.0 (1.93) | 17.0 (0.67) | 71.4 (2.81) | 76.4 (3.01) | M8 x 1.25 | 5/16"–18 UNC 2B | 13–20 Nm |
| 71 | 74.0 (2.91) | 51.5 (2.03) | 51.5 (2.03) | 57.5 (2.26) | 20.0 (0.79) | 72.2 (2.84) | 84.9 (3.34) | M8 x 1.25 | 5/16"–18 UNC 2B | 13–20 Nm |
| 72 | 75.0 (2.95) | 60.0 (2.36) | 60.0 (2.36) | 66.0 (2.60) | 23.0 (0.91) | 72.8 (2.87) | 93.4 (3.68) | M10 x 1.5 | 3/8"–16 UNC 2B | 26–35 Nm |
| 73 | 75.0 (2.95) | 73.5 (2.89) | 73.5 (2.89) | 79.5 (3.13) | 30.0 (1.18) | 73.2 (2.88) | 106.9 (4.21) | M12 x 1.75 | 1/2"–13 UNC 2B | 45–55 Nm |

POWR-SPEED® Fuse

PSR SERIES HIGH-SPEED SQUARE BODY

Time Current Curve (30 Case Size)



* Dc minimum breaking capacity = 9 x Rated Current of Fuse

POWR-SPEED® Fuse

PSR SERIES HIGH-SPEED SQUARE BODY

Time Current Curve (31 Case Size)



* Dc minimum breaking capacity = 9 x Rated Current of Fuse

POWR-SPEED® Fuse

PSR SERIES HIGH-SPEED SQUARE BODY

Time Current Curve (32 Case Size)



* Dc minimum breaking capacity = 9 x Rated Current of Fuse

POWR-SPEED® Fuse

PSR SERIES HIGH-SPEED SQUARE BODY

Time Current Curve (33 Case Size)



* Dc minimum breaking capacity = 9 x Rated Current of Fuse

POWR-SPEED® Fuse

PSR SERIES HIGH-SPEED SQUARE BODY

Time Current Curve (70 Case Size)



* Dc minimum breaking capacity = 9 x Rated Current of Fuse

POWR-SPEED® Fuse

PSR SERIES HIGH-SPEED SQUARE BODY

Time Current Curve (71 Case Size)

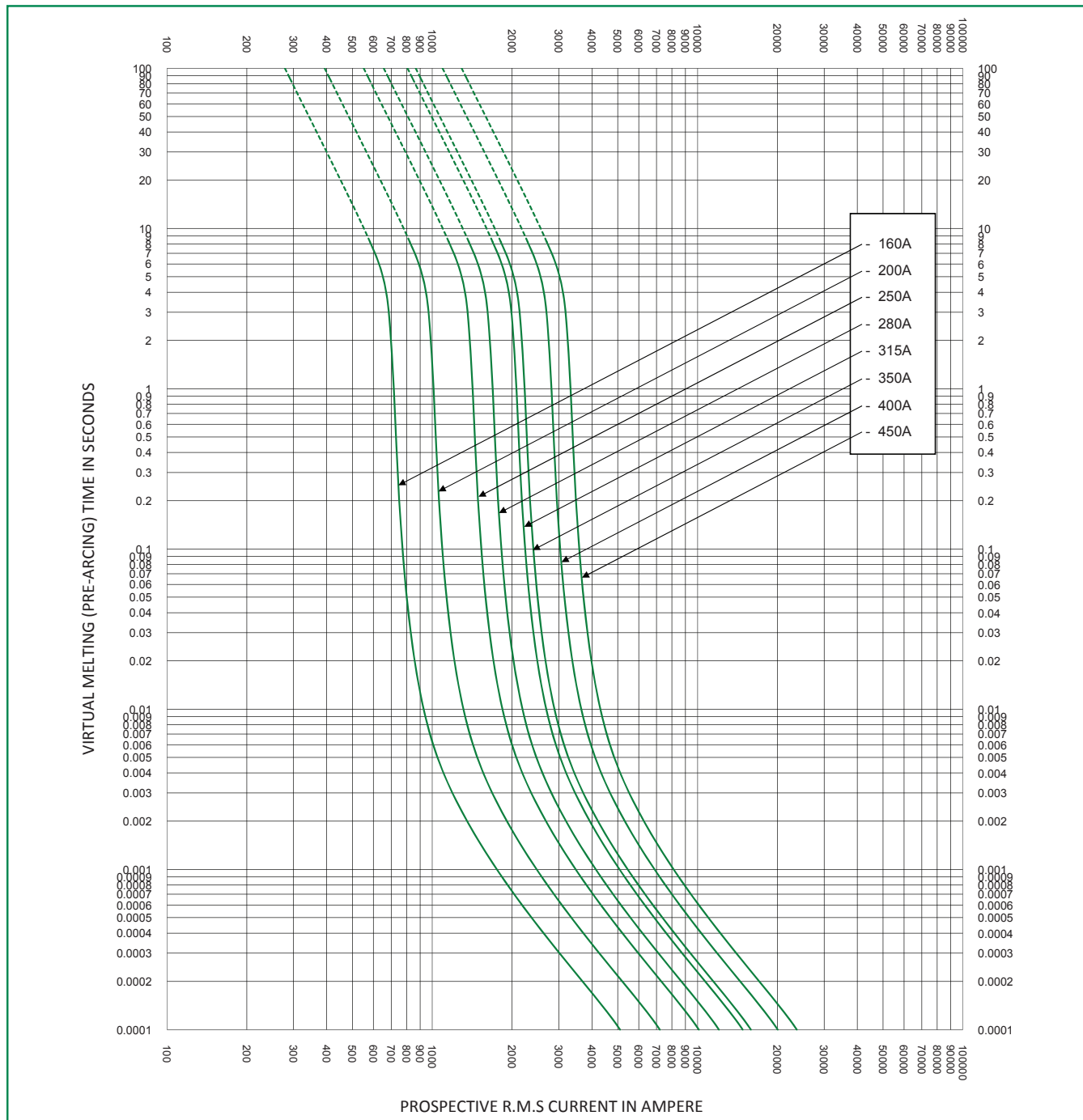

* Dc minimum breaking capacity = 9 x Rated Current of Fuse

Time Current Curve (72 Case Size)



* Dc minimum breaking capacity = 9 x Rated Current of Fuse

Time Current Curve (73 Case Size)

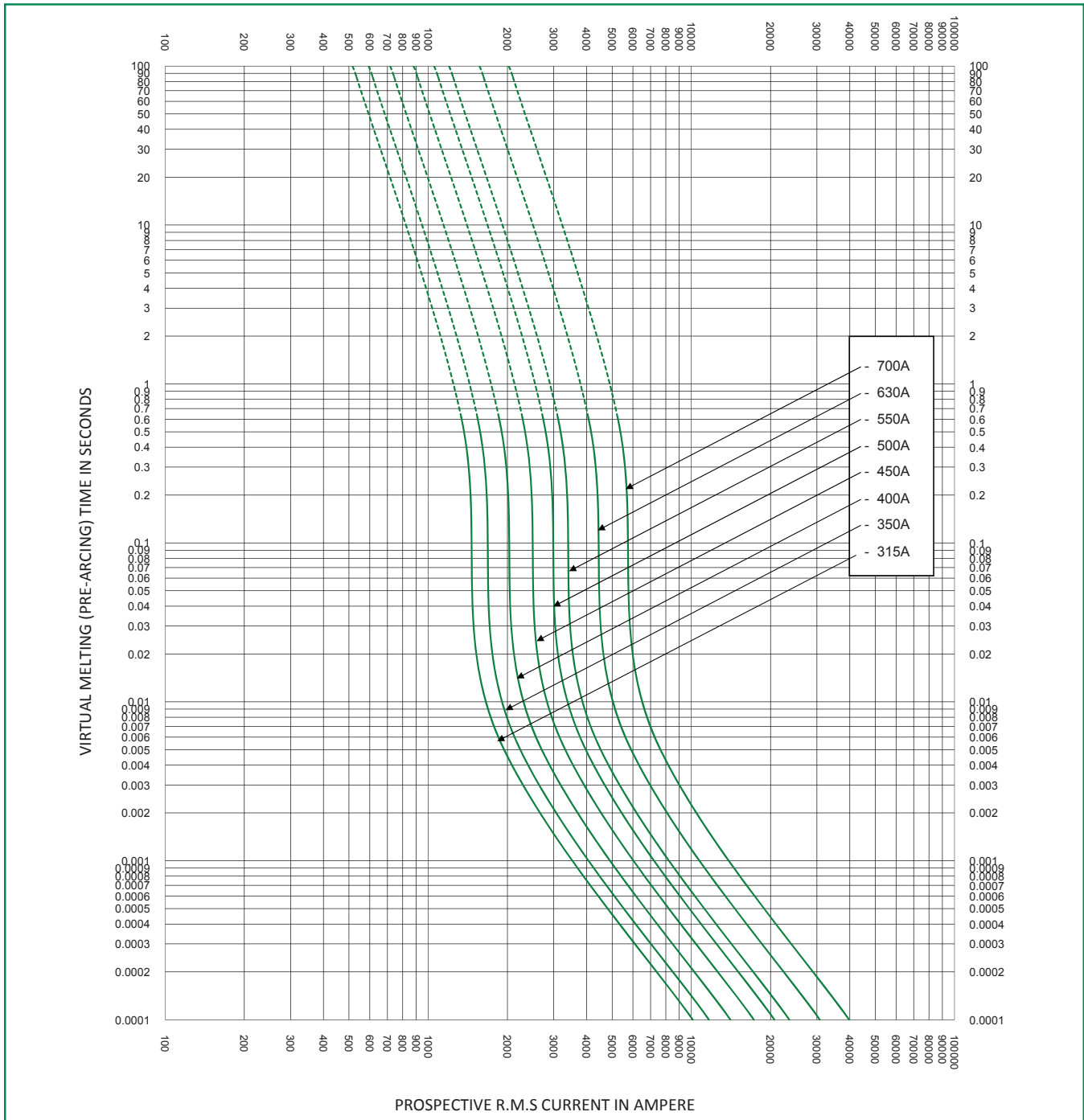

* Dc minimum breaking capacity = 9 x Rated Current of Fuse

Peak Let-Thru Curve (30 Case Size)



Peak Let-Thru Curve (31 Case Size)



Peak Let-Thru Curve (32 Case Size)



Peak Let-Thru Curve (33 Case Size)



Peak Let-Thru Curve (70 Case Size)

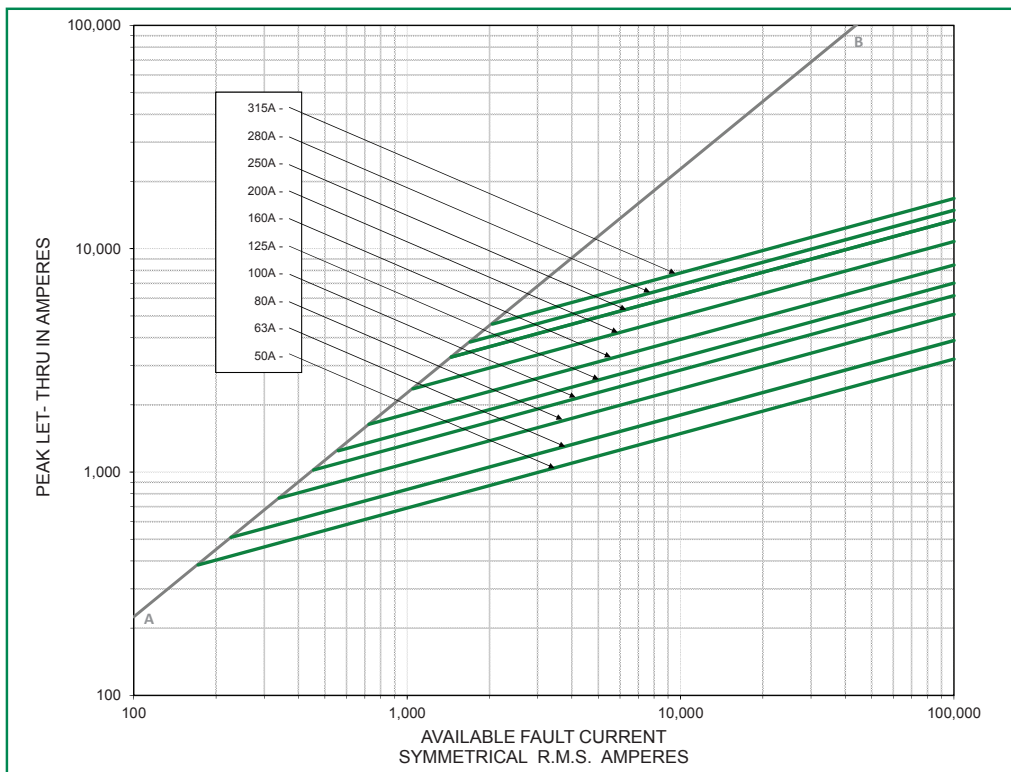

Peak Let-Thru Curve (71 Case Size)

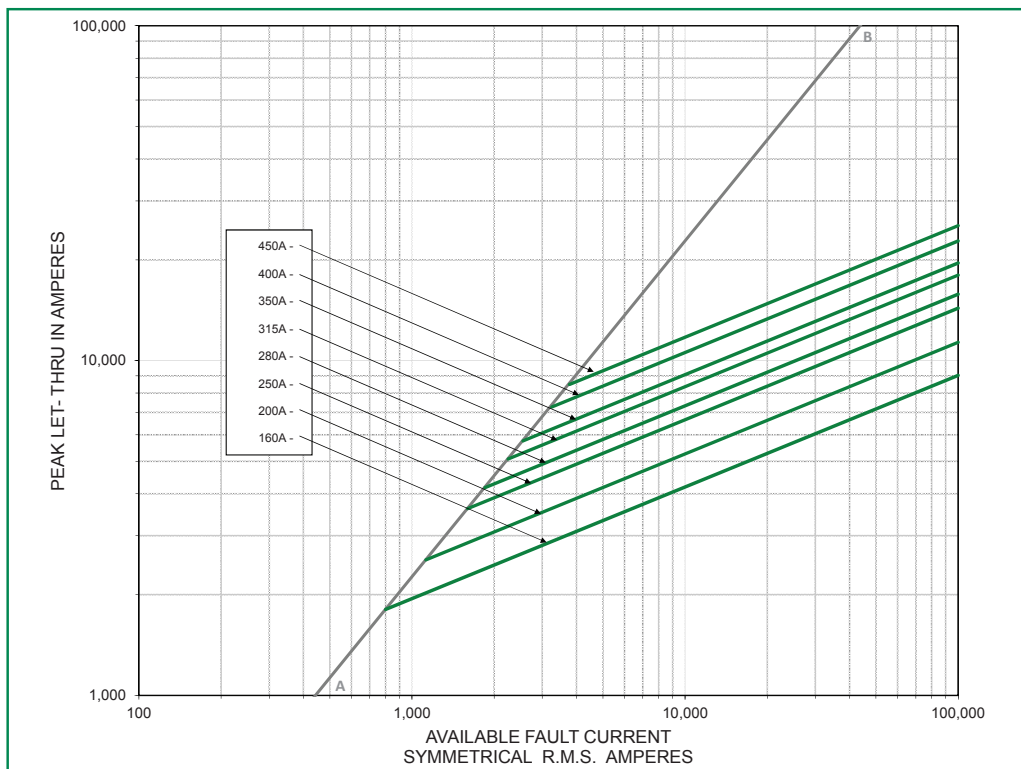

Peak Let-Thru Curve (72 Case Size)



Peak Let-Thru Curve (73 Case Size)



Total Clearing I²t Correction Factor Curve
Case Size (30, 31, 32 and 33)

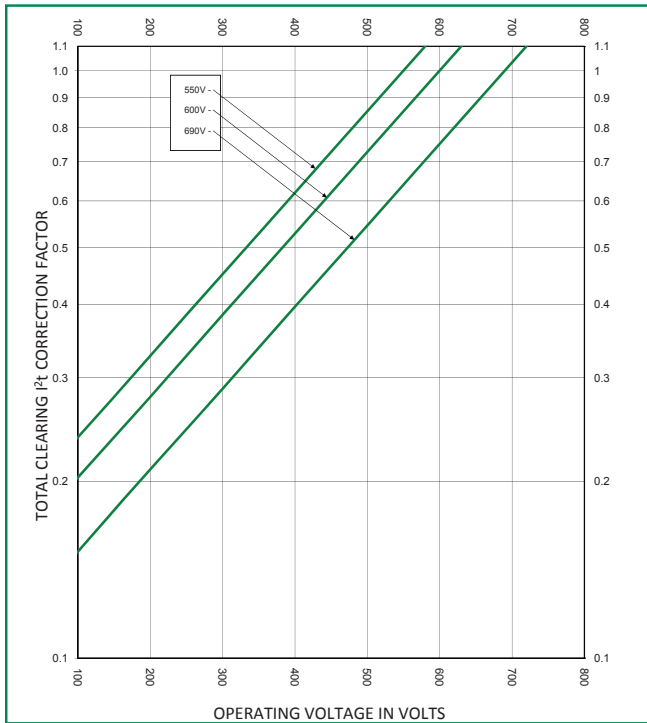

Total Clearing I²t Correction Factor Curve
Case Size (70, 71, 72, and 73)

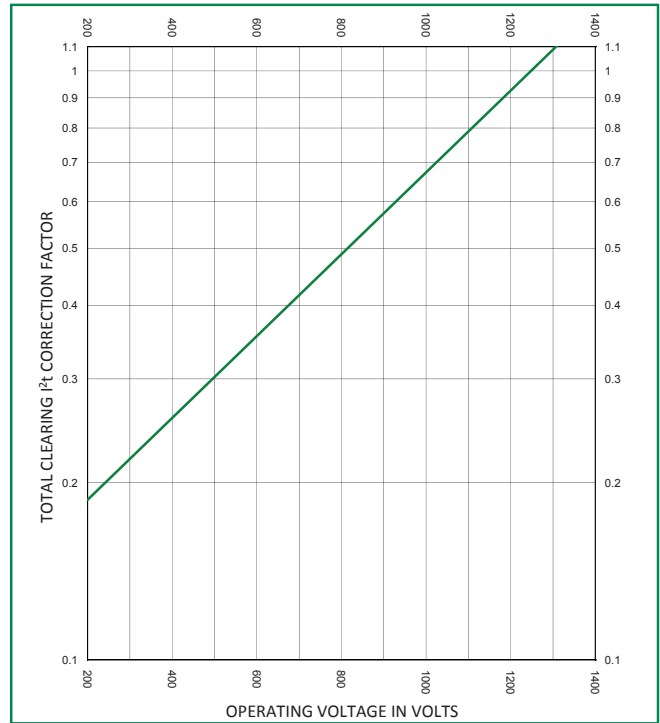

Peak Arc Voltage Curve
Case Size (30, 31, 32 and 33)



Peak Arc Voltage Curve
Case Size (70, 71, 72, and 73)

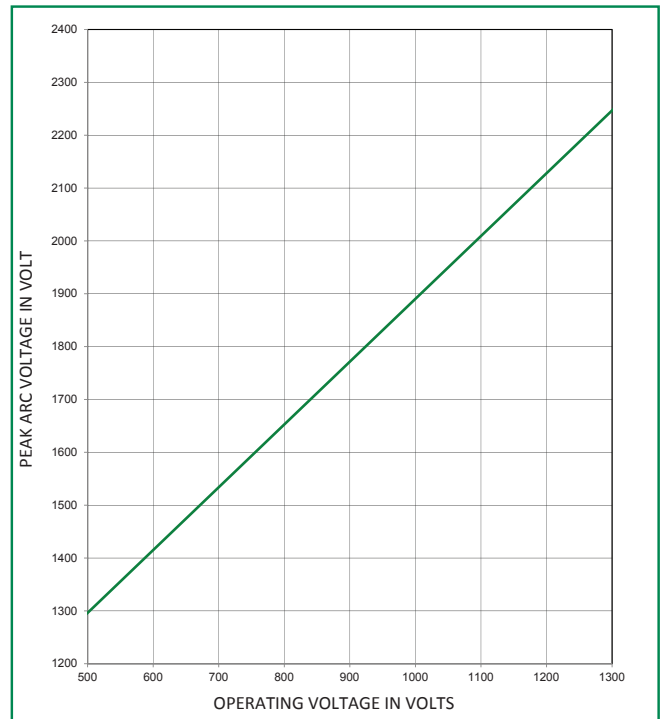

Temperature Derating Curve
 (temperature of air immediately surrounding fuse)



Watts Loss Correction Factor Curve



POWR-SPEED® Fuse

PSR SERIES HIGH-SPEED SQUARE BODY

Microswitch

[Dimensions in millimeters]

MS3H1000C

Document Number: OL-MS3H1000C Rev. B



MS7H1500C

Document Number: OL-MS7H1500C Rev. B

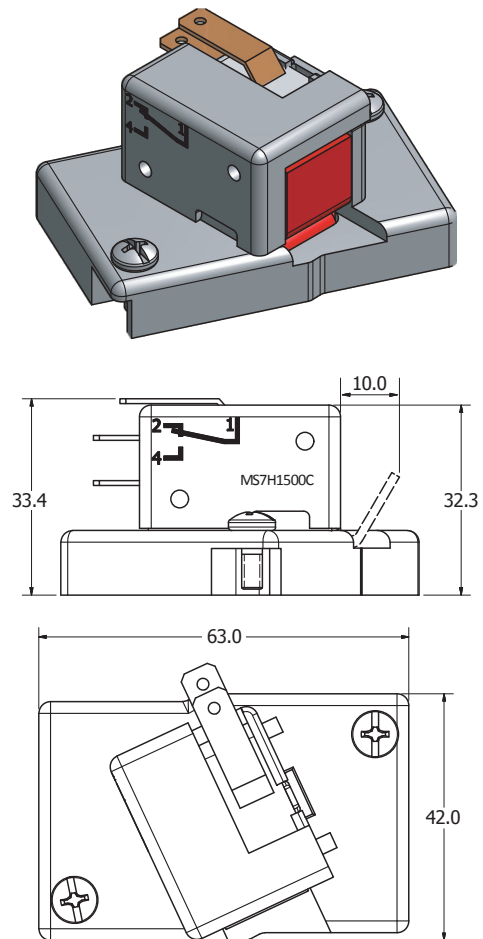

Electrical Characteristics

| CATALOG NUMBER/ ORDERING NUMBER | INDICATING STYLE | INSULATION VOLTAGE RATING (VAC) | FUSE CASE SIZE | POSITIVE OPERATING MIN VOLTAGE / MIN CURRENT | INTERRUPTING RATING | | | | | | OPERATING TEMP. | RELATIVE HUMIDITY | PACK QUANTITY | |
|------------------------------------|------------------|---------------------------------|----------------|--|---------------------|--------------------|-------|-------|-------------------------------|-------|-----------------|-------------------|---------------|-----------|
| | | | | | CURRENT | NON-INDUCTIVE LOAD | | | INDUCTIVE LOAD (DC L/R=25 ms) | | | | | |
| | | | | | | 30 V | 110 V | 250 V | 30 V | 110 V | | | | 250 V |
| MS3H1000C* | Standard NO-NC | 1000 | 30, 31, 32, 33 | 4 V / 1mA | ac (50/60 Hz) | 5 A | 5 A | 5 A | 5 A | 5 A | 4 A | -60 °C to +125 °C | 95 % | 3 pcs/bag |
| | | | | | dc | 5 A | 0.6 A | 0.3 A | 3 A | 0.2 A | 0.1 A | | | |
| MS7H1500C* | Standard NO-NC | 1500 | 70, 71, 72, 73 | | ac (50/60 Hz) | 5 A | 5 A | 5 A | 5 A | 5 A | 4 A | -60 °C to +125 °C | 95 % | 3 pcs/bag |
| | | | | | dc | 5 A | 0.6 A | 0.3 A | 3 A | 0.2 A | 0.1 A | | | |

* Contains internal microswitch (Part Number: U83161.8), listed under UL File: E42016.

Disclaimer Notice – Information furnished is believed to be accurate and reliable. However, users should independently evaluate the suitability of and test each product selected for their own applications. Littelfuse products are not designed for, and may not be used in, all applications. Read complete Disclaimer Notice at www.littelfuse.com/product-disclaimer.

Компания «Life Electronics» занимается поставками электронных компонентов импортного и отечественного производства от производителей и со складов крупных дистрибьюторов Европы, Америки и Азии.

С конца 2013 года компания активно расширяет линейку поставок компонентов по направлению коаксиальный кабель, кварцевые генераторы и конденсаторы (керамические, пленочные, электролитические), за счёт заключения дистрибьюторских договоров

Мы предлагаем:

- Конкуренспособные цены и скидки постоянным клиентам.
- Специальные условия для постоянных клиентов.
- Подбор аналогов.
- Поставку компонентов в любых объемах, удовлетворяющих вашим потребностям.
- Приемлемые сроки поставки, возможна ускоренная поставка.
- Доставку товара в любую точку России и стран СНГ.
- Комплексную поставку.
- Работу по проектам и поставку образцов.
- Формирование склада под заказчика.
- Сертификаты соответствия на поставляемую продукцию (по желанию клиента).
- Тестирование поставляемой продукции.
- Поставку компонентов, требующих военную и космическую приемку.
- Входной контроль качества.
- Наличие сертификата ISO.

В составе нашей компании организован Конструкторский отдел, призванный помогать разработчикам, и инженерам.

Конструкторский отдел помогает осуществить:

- Регистрацию проекта у производителя компонентов.
- Техническую поддержку проекта.
- Защиту от снятия компонента с производства.
- Оценку стоимости проекта по компонентам.
- Изготовление тестовой платы монтаж и пусконаладочные работы.



Тел: +7 (812) 336 43 04 (многоканальный)

Email: org@lifeelectronics.ru