

# Digital Fiber Amplifier E3X-DA-N

## The Ultimate Fiber Amplifier for Maximum Ease of Use and High Performance



**UL991\***

 Be sure to read *Safety Precautions* on page 23.

\* UL certification including UL 991 testing and evaluation • Applicable standards: UL 3121-1  
• Additional application testing and evaluations standards: UL 991 and SEMI S2-0200S

### Features

#### Models with New Connector System Reduces Wiring, Saves Space, and Makes Maintenance Easier

**First in the Industry Patent Pending**

In Amplifiers with wire-saving connectors, the power supply is distributed to 1-conductor slave connectors through a 3-conductor master connector. This design has three major advantages.

1. Wiring time is significantly reduced.
2. Relay connectors are unnecessary, so wiring takes up less space and costs are reduced.
3. Storage and maintenance are simpler because it isn't necessary to distinguish between master connector and slave connectors on the Amplifier.



#### Super Digital Display with Auto Power Control (APC) Circuit

**First in the Industry**

The passage of time causes the intensity of the Sensor's light-emitting LED elements to deteriorate, which may make stable detection impossible.

The E3X-DA-N is the first series of Fiber Sensors to use an Auto Power Control (APC) circuit. This achieves strict detection by eliminating fluctuation in the digital value and is ideal for subtle detection such as stable detection of liquid-crystal glass.



### Power Consumption Reduced by As Much As 70%

Power consumption is reduced by as much as 70% from 1800 mW to 600 mW (when the digital display is OFF).



### Digital Display Can Be Turned OFF or Dimmed during Operation

Eco-mode

When the digital display is viewed infrequently during operation, current consumption can be reduced by dimming the display or turning it OFF entirely. (Eco-mode can be set from the Mobile Console only.)

### New Generation of Mobile Consoles the Size of Cellular Phones. Further Developing the Ultimate Power of Fiber Amplifiers.

#### Remote Setting and Adjustment

Perform settings, teaching, and fine adjustments at the end of the Fiber Unit.

Previously, settings and teaching could be performed only on the Amplifier. Now, however, using a Mobile Console enables these operations at the end of the fiber. Strict adjustments can be made while checking the workpiece position.



#### With group teaching, teach multiple amplifiers simultaneously.

The tedious teaching that had to be performed separately for each Amplifier can now be performed for several Amplifiers at once using the Mobile Console.

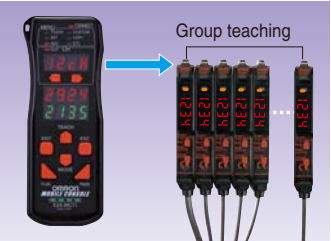

#### Display the light intensity and threshold at the same time.

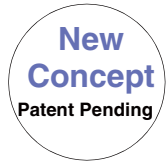

#### Eliminate inconsistency by using group zero reset.

The group zero reset function can simultaneously reset the digital displays of multiple Amplifiers to 0. This function is useful to minimize variation between Amplifier values.

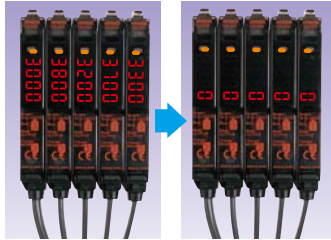

#### Flash the Sensor head and display the amplifier channels during operation.

Even if the Amplifier and Sensor head are separated during operation, it is still possible to flash the Sensor head and display the amplifier channels.

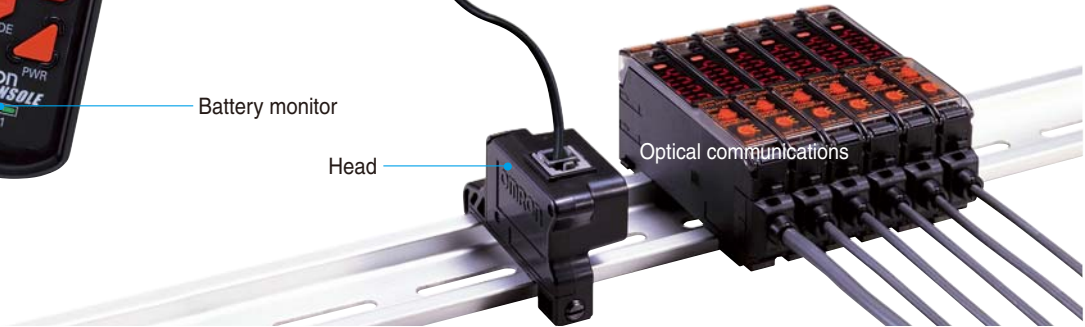

## Ordering Information

### Amplifiers

#### Pre-wired Amplifiers

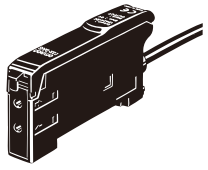
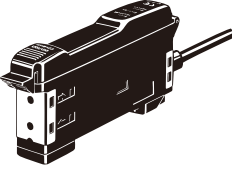
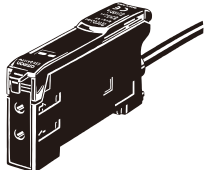
Type	Appearance	Control output	Model	
			NPN output	PNP output
Standard models		ON/OFF output	<b>E3X-DA11-N</b>	<b>E3X-DA41-N</b>
Monitor-output models		• ON/OFF output • Monitor output	<b>E3X-DA21-N</b>	<b>E3X-DA51-N</b>
Mark-detecting models (blue LED)		ON/OFF output	<b>E3X-DAB11-N</b>	<b>E3X-DAB41-N</b>
Mark-detecting models (green LED)			<b>E3X-DAG11-N</b>	<b>E3X-DAG41-N</b>
Infrared models			<b>E3X-DAH11-N</b>	<b>E3X-DAH41-N</b>
Differential-output model*			<b>E3X-DA11D</b>	---
Water-resistant models		ON/OFF output	<b>E3X-DA11V</b>	<b>E3X-DA41V</b>
Twin-output models			<b>E3X-DA11TW</b>	<b>E3X-DA41TW</b>

\* For details, refer to page 6.

#### Amplifiers with Standard Connectors

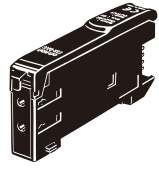
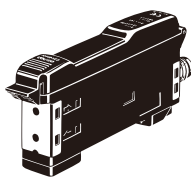
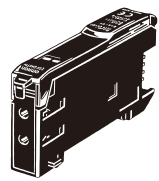
Type	Appearance	Applicable Connector (order separately)		Control output	Model	
					NPN output	PNP output
Standard models		Master	E3X-CN11	ON/OFF output	<b>E3X-DA6</b>	<b>E3X-DA8</b>
		Slave	E3X-CN12			
Monitor-output models		Master	E3X-CN21	• ON/OFF output • Monitor output	<b>E3X-DA7</b>	<b>E3X-DA9</b>
		Slave	E3X-CN22			
Mark-detecting models (Blue LED)		ON/OFF output	Master	E3X-CN11	<b>E3X-DAB6</b>	<b>E3X-DAB8</b>
			Slave	E3X-CN12		
Mark-detecting models (Green LED)		ON/OFF output	Master	E3X-CN11	<b>E3X-DAG6</b>	<b>E3X-DAG8</b>
			Slave	E3X-CN12		
Infrared models		ON/OFF output	Master	E3X-CN11	<b>E3X-DAH6</b>	<b>E3X-DAH8</b>
			Slave	E3X-CN12		
Differential-output model*		ON/OFF output	Master	E3X-CN11	<b>E3X-DA6D</b>	---
			Slave	E3X-CN12		
Water-resistant models (M8 connector)		XS3F-M421-40□-A XS3F-M422-40□-A		ON/OFF output	<b>E3X-DA14V</b>	<b>E3X-DA44V</b>
Twin-output models		Master	E3X-CN21	ON/OFF output	<b>E3X-DA6TW</b>	<b>E3X-DA8TW</b>
		Slave	E3X-CN22			

\* For details, refer to page 6.

**Amplifier Connectors (Order Separately)** Note: Seal provided as accessory.

Type	Appearance	Cable length	No. of conductors	Model
Master Connector		2 m	3	E3X-CN11
			4	E3X-CN21
Slave Connector			1	E3X-CN12
			2	E3X-CN22

**Combining Amplifiers and Connectors (Basically Amplifiers and Connectors are sold separately.)**

Refer to the following tables when placing an order.

Amplifiers			Applicable Connectors (Order Separately)	
Type	NPN	PNP	Master Connector	Slave Connector
Standard models	E3X-DA6	E3X-DA8	E3X-CN11	E3X-CN12
Mark-detecting models	E3X-DAB6	E3X-DAB8		
	E3X-DAG6	E3X-DAG8		
Infrared models	E3X-DAH6	E3X-DAH8		
Differential-output model	E3X-DA6D	---	E3X-CN21	E3X-CN22
Monitor-output models	E3X-DA7	E3X-DA9		
Twin-output models	E3X-DA6TW	E3X-DA8TW		





**When Using 5 Amplifiers**

Amplifiers (5 Units)	+	1 Master Connector	4 Slave Connectors
----------------------	---	--------------------	--------------------

**Sensor I/O Connectors (Order Separately)**

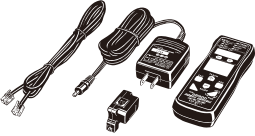

Size	Cable specifications	Appearance	Cable type	Model	
M8	Standard cable	Straight connector 	2 m	4-wire connection	XS3F-M421-402-A
			5 m		XS3F-M421-405-A
		L-shaped connector 	2 m		XS3F-M422-402-A
			5 m		XS3F-M422-405-A

## Mobile Console (Order Separately)

Appearance	Model	Remarks
	(model number of set) <b>E3X-MC11</b>	Mobile Console with head, cable, and AC adapter provided as accessories. Power supply method: chargeable battery
	<b>E3X-MC11-C1</b>	Mobile Console
	<b>E3X-MC11-H1</b>	Head
	<b>E39-Z12-1</b>	Cable (1.5 m)

## Accessories (Order Separately)

### Mounting Brackets

Appearance	Applicable model	Model	Quantity	Remarks
	E3X-DA-N Series	<b>E39-L143</b>	1	---
	E3X-DA□V	<b>E39-L148</b>		

\*When using a Through-beam Fiber Unit, order one Bracket for the Receiver and one for the Emitter.

### Operating Instructions Sticker

Model	Remarks
<b>E39-Y1</b>	Attach near the Sensor. → Refer to page 25.

### End Plate

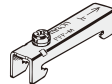
Appearance	Model	Quantity
	<b>PFP-M</b>	1

## Ratings and Specifications

For dimensions, refer to page 26 to 29.

## Amplifiers

## Pre-wired Amplifiers

Item	Output type	Type	Standard models	Monitor-output models	Mark-detecting models		Infrared models	Water-resistant models	Twin-output models
		NPN output	E3X-DA11-N	E3X-DA21-N	E3X-DAB11-N	E3X-DAG11-N	E3X-DAH11-N	E3X-DA11V	E3X-DA11TW
	PNP output	E3X-DA41-N	E3X-DA51-N	E3X-DAB41-N	E3X-DAG41-N	E3X-DAH41-N	E3X-DA41V	E3X-DA41TW	
Light source (wavelength)		Red LED (660 nm)		Blue LED (470 nm)	Green LED (525 nm)	Infrared LED (870 nm)	Red LED (660 nm)		
Power supply voltage		12 to 24 VDC±10%, ripple (p-p) 10% max.							
Power consumption		Normally: 960 mW max. (current consumption: 40 mA max. at power supply voltage of 24 VDC) Eco Mode: 720 mW max. (current consumption: 30 mA max. at power supply voltage of 24 VDC) Digital display not lit: 600 mW max. (current consumption: 25 mA max. at power supply voltage of 24 VDC)							
Control output	ON/OFF output	Load current: 50 mA (residual voltage (NPN/PNP): 1 V max., Open collector (NPN or PNP output, depending on the model) Light ON/Dark ON selectable							
	Monitor output	---	Load 1 to 5 VDC, 10 kΩ min.	---					
Protection circuit		Power supply reverse polarity, Output short-circuit protection, Mutual interference prevention (supported for up to 10 Units)							
Response time	Super-high-speed mode	0.25 ms for operation and reset respectively						0.5 ms for operation and reset respectively	
	Standard mode	1 ms for operation and reset respectively						2 ms for operation and reset	
	Super-long-distance mode	4 ms for operation and reset respectively						7 ms for operation and reset respectively	
Sensitivity setting		Teaching or manual method							
Functions	Timer function	OFF-delay timer: 0 to 200 ms, 1 to 20 ms (set in 1-ms units); 20 to 200 ms (set in 5-ms units) Using Mobile Console: OFF delay, ON delay, or one shot (selectable)							
	Automatic power control (APC)	Fiber-optic current digital control			---			Fiber-optic current digital control	
	Zero-reset	Negative values can be displayed.							
	Initial reset	Settings can be returned to defaults as required.							
	Monitor focus	---	Upper and lower limits can be set as required for every 100 digital values.	---					
Indicators		Operation indicator (orange), 7-segment digital incident level display (red), 7-segment digital incident level percentage display (red), threshold and excess gain 2-color double bar indicators (green and red), 7-segment digital threshold display (red)							
Display timing		Switching between normal/peak-hold/bottom-hold possible							
Display orientation		Switching between normal/reverse possible							
Optical axis adjustment		Optical axis adjustment possible (hyper-flashing function)							
Ambient illumination (receiver side)		Incandescent lamp: 10,000 lx max. Sunlight: 20,000 lx max.							

Item	Output type	Type	Standard models	Monitor-output models	Mark-detecting models		Infrared models	Water-resistant models	Twin-output models
		NPN output	E3X-DA11-N	E3X-DA21-N	E3X-DAB11-N	E3X-DAG11-N	E3X-DAH11-N	E3X-DA11V	E3X-DA11TW
		PNP output	E3X-DA41-N	E3X-DA51-N	E3X-DAB41-N	E3X-DAG41-N	E3X-DAH41-N	E3X-DA41V	E3X-DA41TW
<b>Ambient temperature</b>			Operating: Groups of 1 to 3 Amplifiers: -25 to 55°C Groups of 4 to 11 Amplifiers: -25 to 50°C Groups of 12 to 16 Amplifiers: -25 to 45°C Storage: -30 to 70°C (with no icing or condensation)						
<b>Ambient humidity</b>			Operating and storage: 35% to 85% (with no condensation)						
<b>Insulation resistance</b>			20 MΩ min. (at 500 VDC)						
<b>Dielectric strength</b>			1,000 VAC at 50/60 Hz for 1 min						
<b>Vibration resistance (destruction)</b>			10 to 55 Hz with a 1.5-mm double amplitude for 2 h each in X, Y and Z directions						
<b>Shock resistance (destruction)</b>			500m/s <sup>2</sup> , for 3 times each in X, Y and Z directions						
<b>Degree of protection</b>			IEC IP50 (with Protective Cover attached)					IEC IP66 (with Protective Cover attached)	IEC IP50 (with Protective Cover attached)
<b>Connection method</b>			Pre-wired (standard cable length: 2 m)						
<b>Weight (packed state)</b>			Approx. 100 g					Approx. 110 g	Approx. 100 g
<b>Material</b>	<b>Case</b>		Polybutylene terephthalate (PBT)						
	<b>Cover</b>		Polycarbonate						Polyethersulfone
<b>Accessories</b>			Instruction sheet						

## Amplifiers with Connectors (Specifications different to those for Pre-wired Amplifiers)

Item	Output type	Type	Standard models	Monitor-output models	Mark-detecting models		Infrared models	Water-resistant models*	Twin-output models
		NPN output	E3X-DA6	E3X-DA7	E3X-DAB6	E3X-DAG6	E3X-DAH6	E3X-DA14V	E3X-DA6TW
		PNP output	E3X-DA8	E3X-DA9	E3X-DAB8	E3X-DAG8	E3X-DAH8	E3X-DA44V	E3X-DA8TW
<b>Connection method</b>			Standard connector					M8 connector	Standard connector
<b>Weight (packed state)</b>			Approx. 55 g					Approx. 65 g	Approx. 55 g

\*The dielectric strength for water-resistant models is 500 VAC at 50/60 Hz for 1 min.

## Connectors

Item	Model	E3X-CN11/21/22	E3X-CN12
<b>Rated current</b>		2.5 A	
<b>Rated voltage</b>		50 V	
<b>Contact resistance</b>		20 mΩ max. (20 mVDC max., 100 mA max.) The figure is for connection to the Amplifier and the adjacent Connector. It does not include the conductor resistance of the cable.	
<b>No. of insertions (durability)</b>		50 times The figure for the number of insertions is for connection to the Amplifier and the adjacent Connector.	
<b>Material</b>	<b>Housing</b>	Polybutylene terephthalate (PBT)	
	<b>Contacts</b>	Phosphor bronze/gold-plated nickel	
<b>Weight (packed state)</b>		Approx. 55 g	Approx. 25 g

## Mobile Console

Item	Model	E3X-MC11
<b>Power supply voltage</b>		Charged with AC adapter
<b>Connection method</b>		Connected via adapter
<b>Weight (packed state)</b>		Approx. 580 g (Console only: 120 g)

Refer to *Instruction Manual* provided with the Mobile Console for details.

## Digital Fiber Amplifiers with Differential Outputs (E3X-DA11D/E3X-DA6D)

### Characteristics of Applicable Fiber Units

#### Through-beam Fiber Units

Sensitivity selection 11-level setting Response time Fiber Unit	Sensing distance (mm) (The figures in parentheses apply when using the 39-F1 Lens Unit.)						Standard object (mm) *1 (min. sensing object *2: opaque)
	HIGH			LOW			
	1	2	3 to 11	1	2	3 to 11	
	270 or 570 $\mu$ s	0.5 or 1 ms	1 to 200 ms or 2 to 400 ms	270 or 570 $\mu$ s	0.5 or 1 ms	1 to 200 ms or 2 to 400 ms	
E32-T11R	240 (1680)	280 (1960)	370 (2590)	140 (980)	180 (1260)	240 (1680)	1 dia. (0.01 dia.)
E32-T21R	50	60	80	30	40	50	
E32-T16WR	580	690	910	350	450	580	(0.3 dia.) *1
E32-T16PR	380	450	600	230	290	380	(0.2 dia.) *2

\*1. These values are for sensing objects that are moving.

\*2. This value applies when the response time is set to 3 to 11. An object of this value is detectable if the temperature changes within the range of ambient operating temperature. (The value is for sensing objects that are moving.)

\*3. The values given in the above table are those that can be detected at a digital value of 1,000 in each sensing area.

#### Reflective Fiber Units

Sensitivity selection 11-level setting Response time Fiber Unit	Sensing distance (mm) *1						Standard object (mm) *2 (min. sensing object *3: opaque)
	HIGH			LOW			
	1	2	3-11	1	2	3-11	
	270 or 570 $\mu$ s	0.5 or 1 ms	1 to 200 ms or 2 to 400 ms	270 or 570 $\mu$ s	0.5 or 1 ms	1 to 200 ms or 2 to 400 ms	
E32-D11R	80	90	120	45	60	80	150 $\times$ 150 (0.01 dia.)
E32-D21R	13	15	20	7	10	13	25 $\times$ 25 (0.01 dia.)

\*1. Sensing distances are given for white paper.

\*2. These values are for sensing objects that are moving.

\*3. This value applies when the response time is set to 3 to 11. An object of this value is detectable if the temperature changes within the range of ambient operating temperature. (The value is for sensing objects that are moving.)

#### Differences Compared with E3X-DA-N Amplifier

Item	Type NPN output	Differential-output Models (Edge-detection Models)	
		Pre-wired	Wire-saving connector
		E3X-DA11D	E3X-DA6D
Current consumption		960 mW max. (current consumption: 40 mA max. at power supply voltage of 24 VDC)	
Control output	ON/OFF output	Load current: 50 mA max., (Residual voltage: 1 V max. for NPN/PNP output)	
		Open collector Switchable between Light ON (ON at edge detection) and Dark ON (OFF at edge detection)	
Detection mode		Switchable between single edge and double edge detection mode	
Response time		Single edge: Can be set to 270 $\mu$ s, 500 $\mu$ s, 1 ms, 2 ms, 4 ms, 10 ms, 20 ms, 30 ms, 50 ms, 100 ms, or 200 ms. Double edge: Can be set to 570 $\mu$ s, 1 ms, 2 ms, 4 ms, 10 ms, 20 ms, 30 ms, 50 ms, 100 ms, 200 ms or 400 ms.	
Func-tions	Timer functions	Light ON: OFF-delay timer, Dark ON: ON-delay timer 0 to 5 s (1 to 20 ms: 1-ms units, 20 to 200 ms: 5-ms units, 200 ms to 1 s: 100 ms, 1 to 5 s: 1-s units)	
	APC	Yes	
	Zero-reset	Yes (Negative values can be displayed.)	
	Initial reset	Yes (Settings can be returned to defaults.)	
	Sensitivity selection	Yes (HIGH/LOW)	
Teaching level		One-point teaching level can be varied from 1% to 50% in increments of 1%	
Indicators		Operation indicator (orange), 7-segment digital incident level display (red), 7-segment digital detection level display (red)	

For other information, refer to the instruction manual supplied with the product.



Engineering Data (Typical)

E3X-DA-N/E3X-DA□V/E3X-DA□TW

**Parallel Operating Range** At maximum sensitivity. (Use for optical axis adjustment at installation.)

**Through-beam**  
**E32-T11L**



**Through-beam**  
**E32-T11L + E39-F1 (separately sold**  
**Long-distance Lens Unit)**



**Through-beam**  
**E32-T12L**



**Through-beam**  
**E32-TC200**



**Through-beam**  
**E32-TC200 + E39-F1 (separately sold**  
**Long-distance Lens Unit)**



**Through-beam**  
**E32-T11R**



**Through-beam**  
**E32-T12R**



**Through-beam**  
**E32-T21R**



**Through-beam**  
**E32-T22R**



**Through-beam**  
**E32-T11**

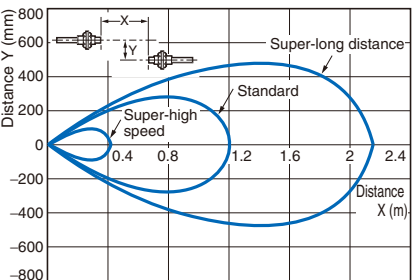

**Through-beam**  
**E32-T22B**

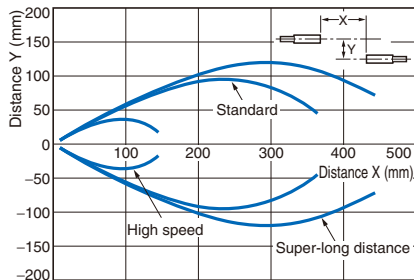

**Through-beam**  
**E32-T14LR**

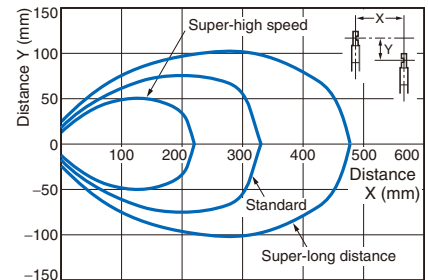

**Through-beam  
E32-T24R**



**Through-beam  
E32-T61**



**Through-beam  
E32-T24S**



**Through-beam  
E32-T16J**

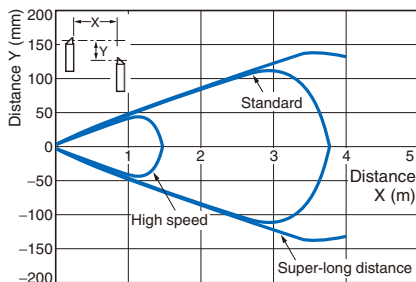

**Through-beam  
E32-T16P**

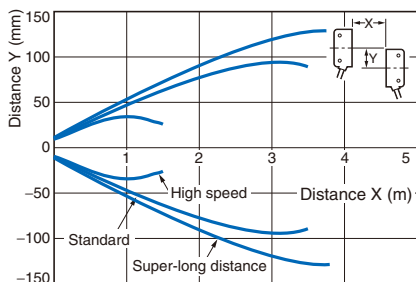

**Through-beam  
E32-T81R**

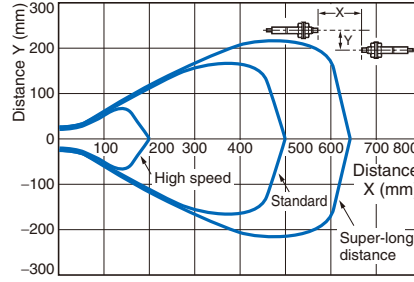

**Through-beam  
E32-T61 + E39-F1 (separately sold  
Long-distance Lens Unit)**



**Through-beam  
E32-T16W**



**Through-beam  
E32-T16J**

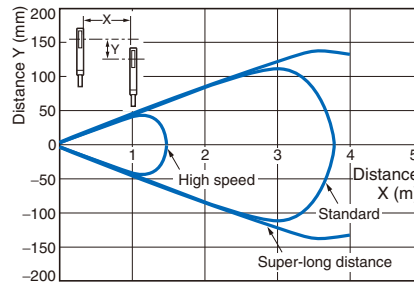

**Through-beam  
E32-T16PR**

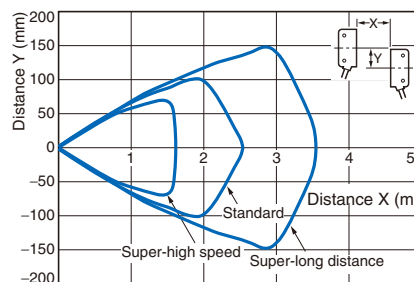

**Through-beam  
E32-T51**



**Through-beam  
E32-T22S**



**Through-beam  
E32-T16WR**



**Through-beam  
E32-T16JR**

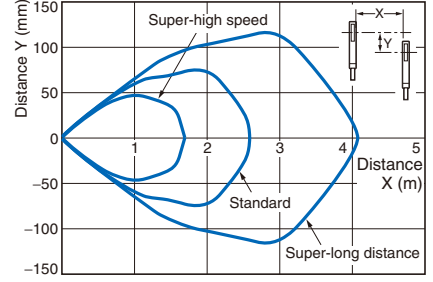

**Operating Range** With standard sensing object at maximum sensitivity. (Use for the positioning of the object and Sensor.)

**Reflective  
E32-D21L**

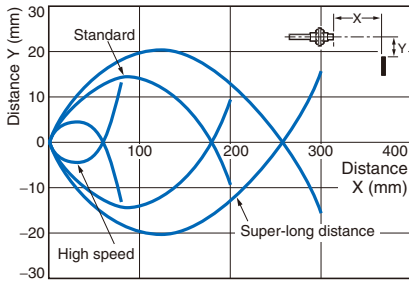

**Reflective  
E32-DC200**

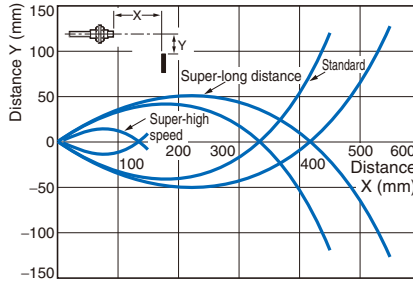

**Reflective  
E32-D11R**

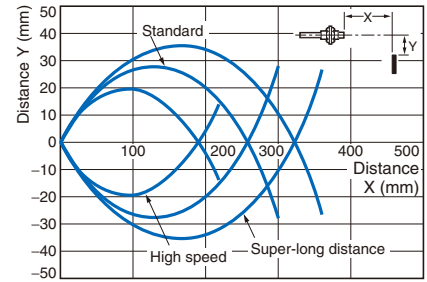

**Reflective  
E32-D12R**

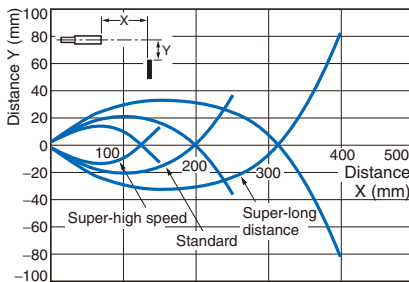

**Reflective  
E32-D21R**

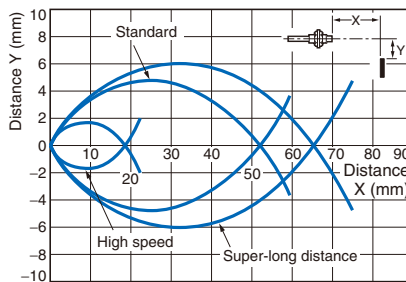

**Reflective  
E32-D22R**

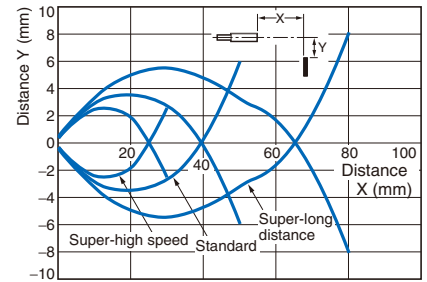

**Reflective  
E32-D33**

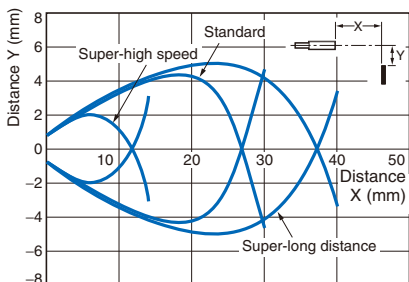

**Reflective  
E32-D331**

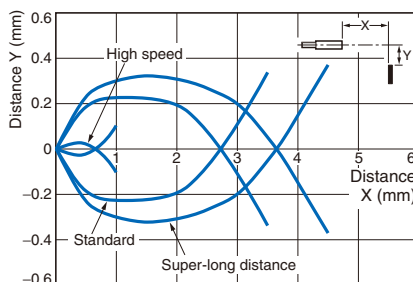

**Reflective  
E32-D21B**

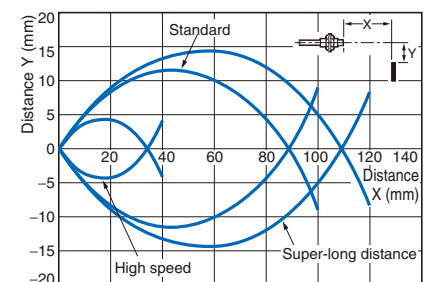

**Reflective  
E32-D22B**



**Reflective  
E32-C31**

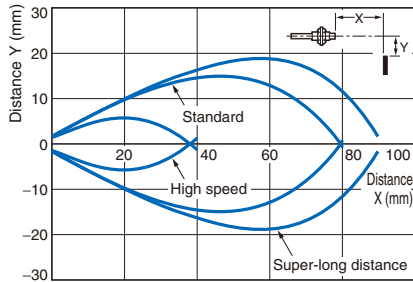

**Reflective  
E32-C41**



**Reflective  
E32-C42**



**Reflective  
E32-D32**



**Reflective  
E32-D14LR**



**Reflective  
E32-D24**



**Reflective  
E32-D24R**



**Reflective  
E32-D61**



**Reflective  
E32-D36P1**



**Reflective  
E32-D36P1**



**Reflective  
E32-L56E**



**Limited Reflective  
E32-L25L**



**Excess Gain Ratio vs. Distance** With standard sensing object at maximum sensitivity.

**Through-beam  
E32-TC200**



**Reflective  
E32-DC200**



**Reflective  
E32-D21L**



**Operating Range  
Reflective  
E32-DC200**



**Hysteresis vs. Sensing Distance  
Reflective  
E32-D11L**



**Repeat Accuracy vs. Sensing Distance  
Reflective  
E32-DC200**



**E3X-DA-N**

**Monitor Output vs. Distance (Standard Mode)**

**Through-beam  
E32-TC200**



**Reflective  
E32-DC200**



**E3X-DAB-N/E3X-DAG-N**

**Parallel Operating Range** At maximum sensitivity. (Use for optical axis adjustment at installation.)

**Through-beam**  
**E32-TC200**



**Through-beam**  
**E32-TC200 + E39-F1 (separately sold Long-distance Lens Unit)**

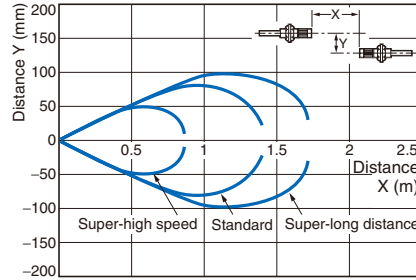

**Operating Range** With standard sensing object at maximum sensitivity. (Use for the positioning of the object and Sensor.)

**Reflective**  
**E32-DC200**



**Reflective**  
**E32-CC200**

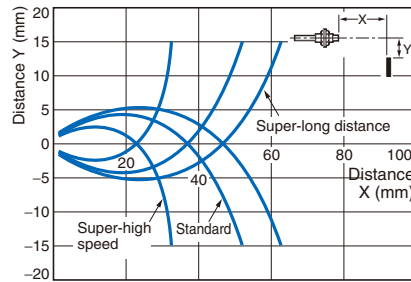

**Limited Reflective**  
**E32-D11L**

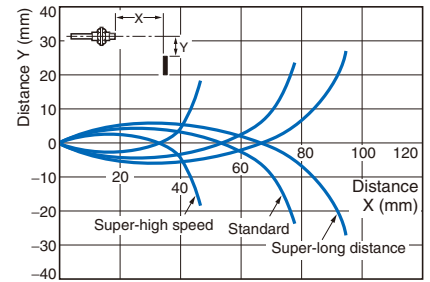

**E3X-DAH-N**

**Parallel Operating Range** At maximum sensitivity. (Use for optical axis adjustment at installation.)

**Through-beam**  
**E32-TC200**

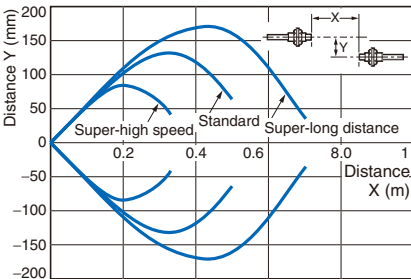

**Through-beam**  
**E32-T11L**

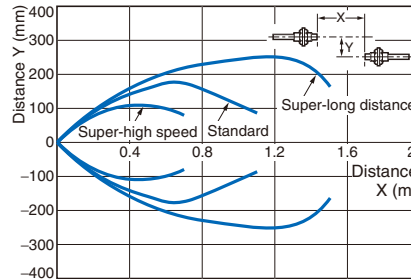

**Through-beam**  
**E32-T14**



**Operating Range** With standard sensing object at maximum sensitivity. (Use for the positioning of the object and Sensor.)

**Reflective**  
**E32-DC200**

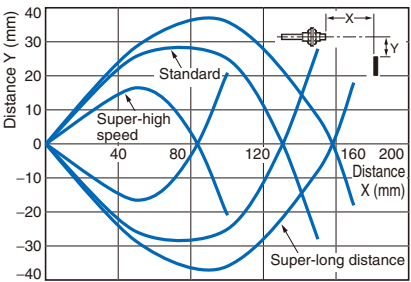

**Reflective**  
**E32-D11L**

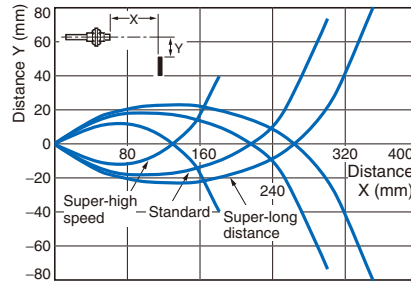

**Limited Reflective**  
**E32-CC200**

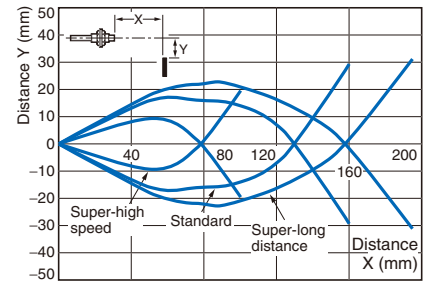

For other information on Fiber Units, refer to the Fiber Sensors Best Selection Catalog (Cat. No. E353).

Technical Reference (for E3X-DA-TW Twin-output Models)

(In the following examples, threshold 1 is set to 3,000, and threshold 2 is set to 1,000.)

Output Patterns for Normal Operation

Outputs 1 and 2 can be set to operate independently and either Light ON mode or Dark ON mode can be selected (independently) for channels 1 and 2 making a total of 4 possible output patterns.

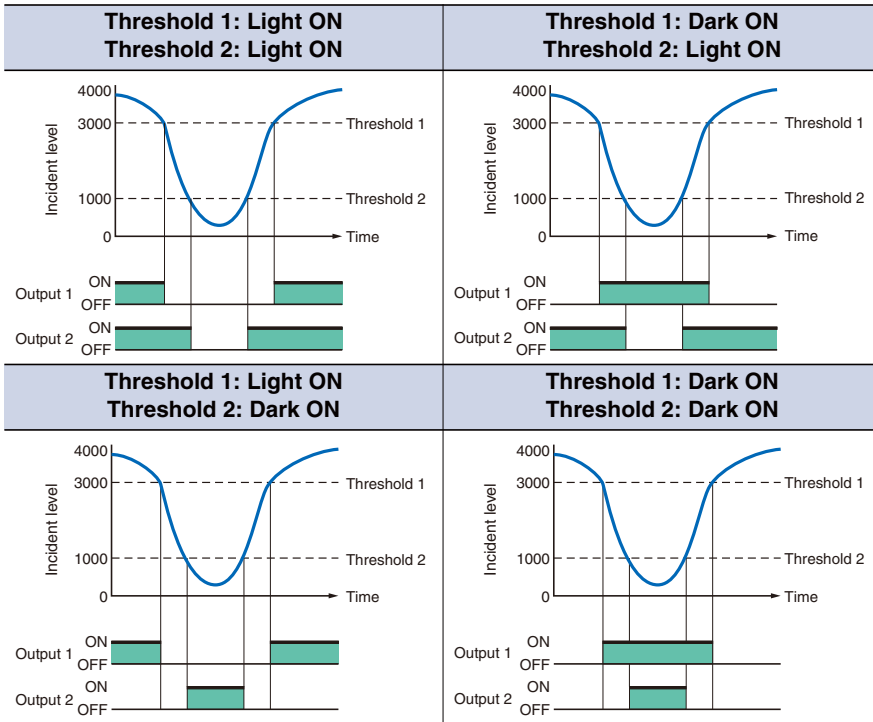

Output Patterns for Area Sensing

This series includes models equipped with area sensing functionality, a first for Digital Fiber Amplifiers. This functionality can be used to monitor whether the incident level is inside or outside the threshold area. The 2 output patterns below are possible for this kind of operation.

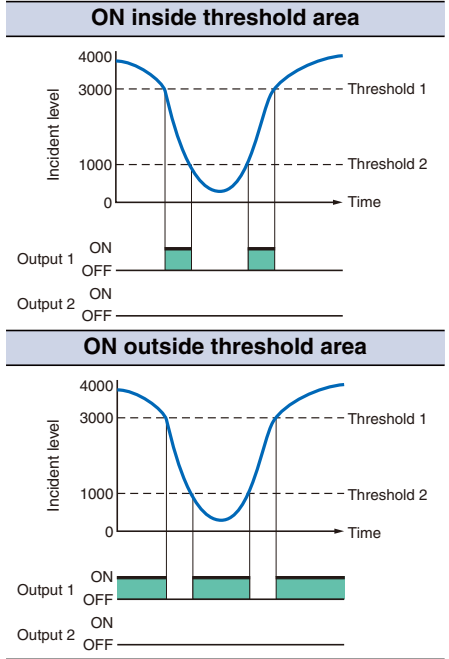

Note: Output 2 is always OFF.

## I/O Circuit Diagrams

### NPN Output

Model	Operation mode	Timing charts	Mode selector switch	Output circuit
E3X-DA11-N E3X-DAB11-N E3X-DAG11-N E3X-DAH11-N E3X-DA11V E3X-DA6 E3X-DAB6 E3X-DAG6 E3X-DAH6 E3X-DA14V	Light-ON		L-ON (LIGHT ON)	
	Dark-ON		D-ON (DARK ON)	<p>• Connector Pin Arrangement (M-8 Connector only) Note: Pin 2 is not used.</p>
E3X-DA21-N E3X-DA7	Light-ON		L-ON (LIGHT ON)	
	Dark-ON		D-ON (DARK ON)	<p>* Load resistance: 10 kΩ min.</p>
E3X-DA11TW E3X-DA6TW	Light-ON		L-ON (LIGHT ON)	
	Dark-ON		D-ON (DARK ON)	

Note: With E3X-DA□TW models, only channel 1 is output when set for area sensing operation.  
 LIGHT ON: ON when the incident level is between the thresholds for channels 1 and 2.  
 DARK ON: OFF when the incident level is between the thresholds for channels 1 and 2. (Channel 2 is always OFF.)

### Sensor I/O Connectors for Models with M8 Connectors

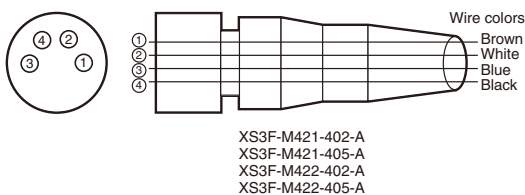

Classification	Wire colors	Connection pin No.	Application
DC	Brown	1	Power supply (+V)
	White	2	---
	Blue	3	Power supply (0 V)
	Black	4	Output

Note: Pin 2 is not used.



## PNP Output

Model	Operation mode	Timing charts	Mode selection switch	Output circuit
E3X-DA41-N E3X-DAB41-N E3X-DAG41-N E3X-DAH41-N E3X-DA41V E3X-DA8 E3X-DAB8 E3X-DAG8 E3X-DAH8 E3X-DA44V	Light-ON		L-ON (LIGHT ON)	
	Dark-ON		D-ON (DARK ON)	
E3X-DA51-N E3X-DA9	Light-ON		L-ON (LIGHT ON)	
	Dark-ON		D-ON (DARK ON)	
E3X-DA41TW E3X-DA8TW	Light-ON		L-ON (LIGHT ON)	
	Dark-ON		D-ON (DARK ON)	

Note: With E3X-DA□TW models, only channel 1 is output when set for area sensing operation.  
 LIGHT ON: ON when the incident level is between the thresholds for channels 1 and 2.  
 DARK ON: OFF when the incident level is between the thresholds for channels 1 and 2. (Channel 2 is always OFF.)

## Sensor I/O Connectors for Models with M8 Connectors

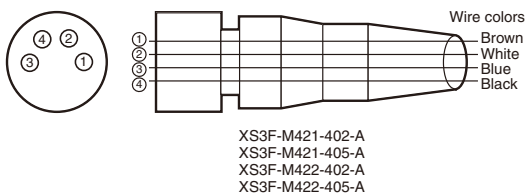

Classification	Wire colors	Connection pin No.	Application
DC	Brown	1	Power supply (+V)
	White	2	---
	Blue	3	Power supply (0 V)
	Black	4	Output

Note: Pin 2 is not used.

## Connection

### Connection with K3NX-VD2 Process Meter

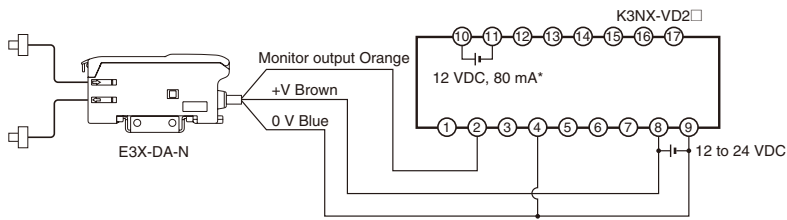

- Note 1. Various I/O Units are available for the K3NX. Select an appropriate output type depending on the application.  
 2. This wiring is for the K3NX with DC power supply specifications and the Monitor (Analog) Sensor with DC power supply specifications. Check respective power supply specifications before wiring.  
 \* Use this service power supply for the Sensor with reference to the power consumption of each Sensor.

## Nomenclature

### Amplifiers

#### Standard, Monitor-output, Mark-detecting, Infrared, and Water-resistant Models

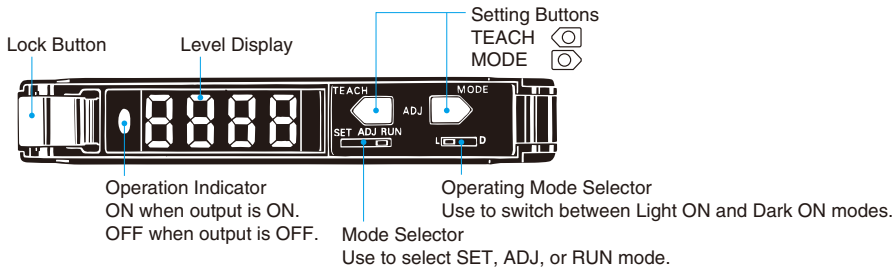

#### Twin-output Models

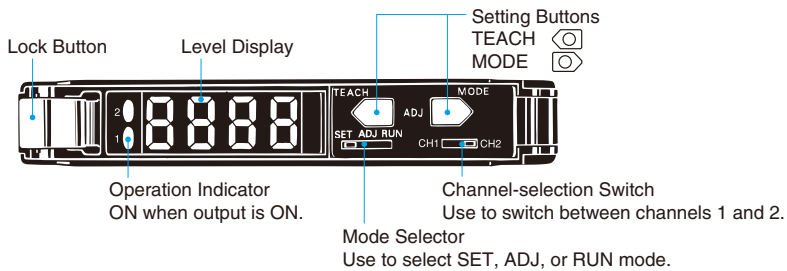

# Amplifier Adjustments

## All Models

### 1 Changing the Display (RUN Mode)

Set the mode selector to RUN. (Factory-set to RUN)

Digital incident level (4000 max.)

2 s MODE

Digital percent

2 s MODE

Analog incident level and threshold

2 s MODE

Digital incident level (4000 max.)

**Manual Tuning (Fine Sensitivity Adjustment) in ADJ Mode**

Perform fine sensitivity adjustment after teaching and manual tuning (without using the teaching function) in the way shown below:

**Twin-output Models**

First, select the channel to be adjusted using the channel selection switch.

CH1  CH2

Set the mode selector to ADJ.

**Fine sensitivity adjustment**

TEACH MODE

Sensitivity increment with threshold decrement      Sensitivity decrement with threshold increment

The items displayed in ADJ mode vary with the display setting in RUN mode.

RUN mode	ADJ mode
Digital incident level	Digital threshold
Digital percent	Digital percent
Analog value	Analog value

### 2 Zero-reset (RUN Mode)

Set the mode selector to RUN.

Digital incident level (4000 max.)

TEACH 1 s

To reset to zero again:

TEACH 1 s

To return the initial digital incident level:

TEACH MODE Hold down both for 3 s

\*There is no limit on the number of times zero-reset can be used.

### 3 Initial Reset (SET Mode)

Set the mode selector to SET.

TEACH MODE Hold down both for 5 s

TEACH

MODE

Cancel      Execute initial reset

4 Setting Functions in SET Mode

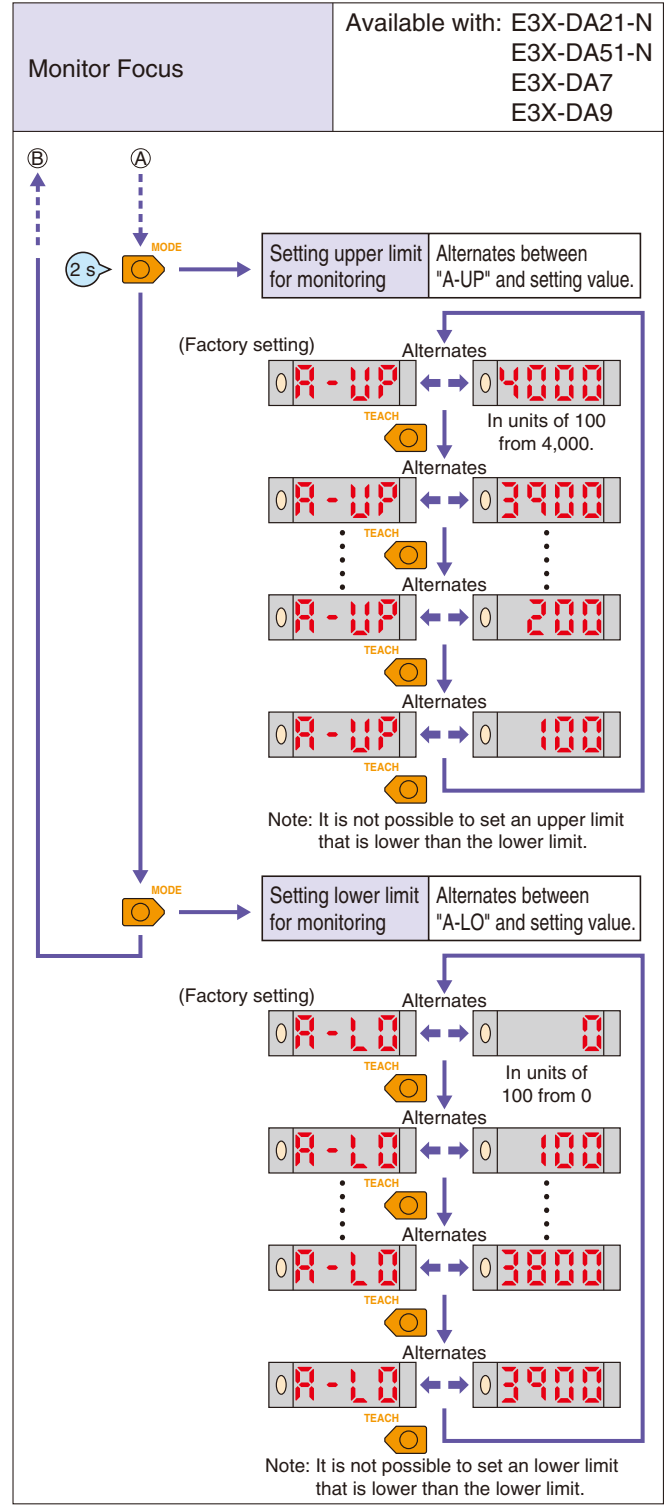
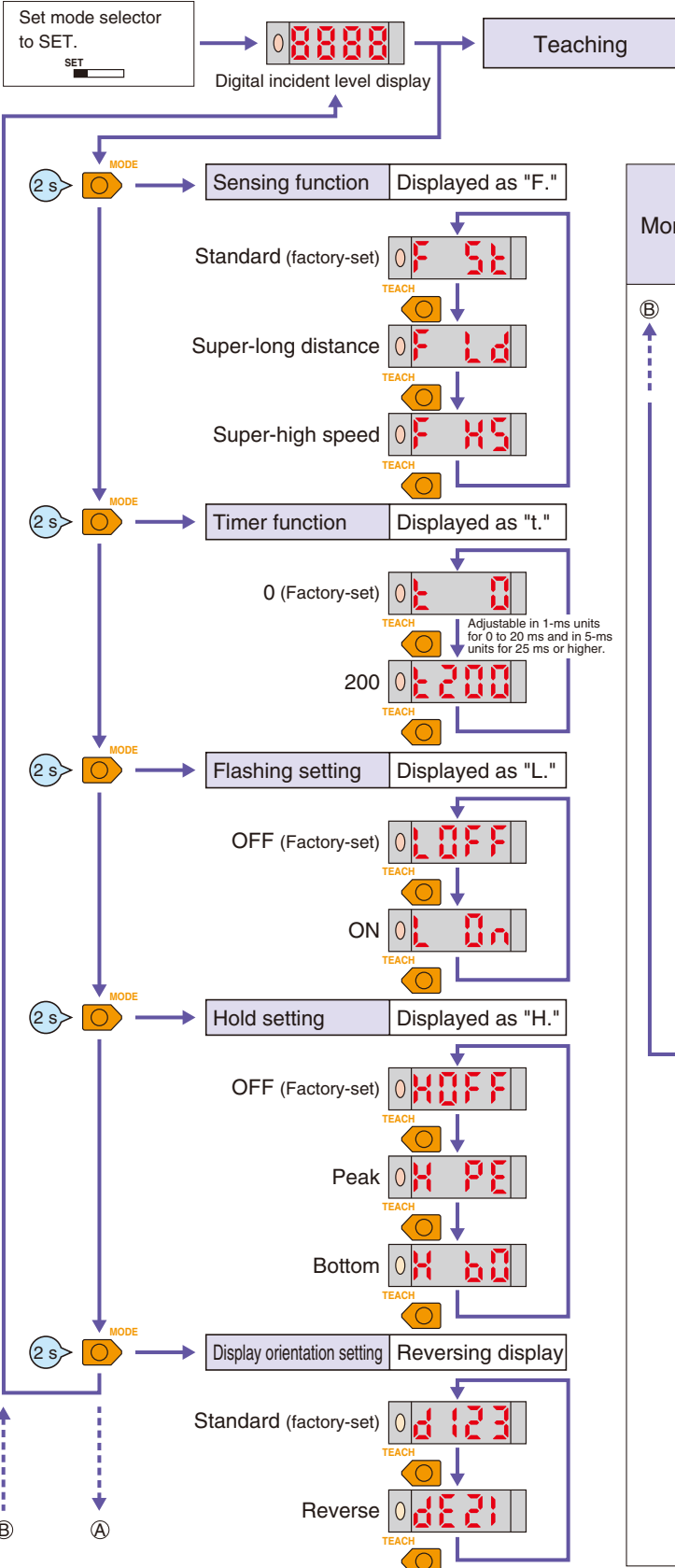

Twin-output Models

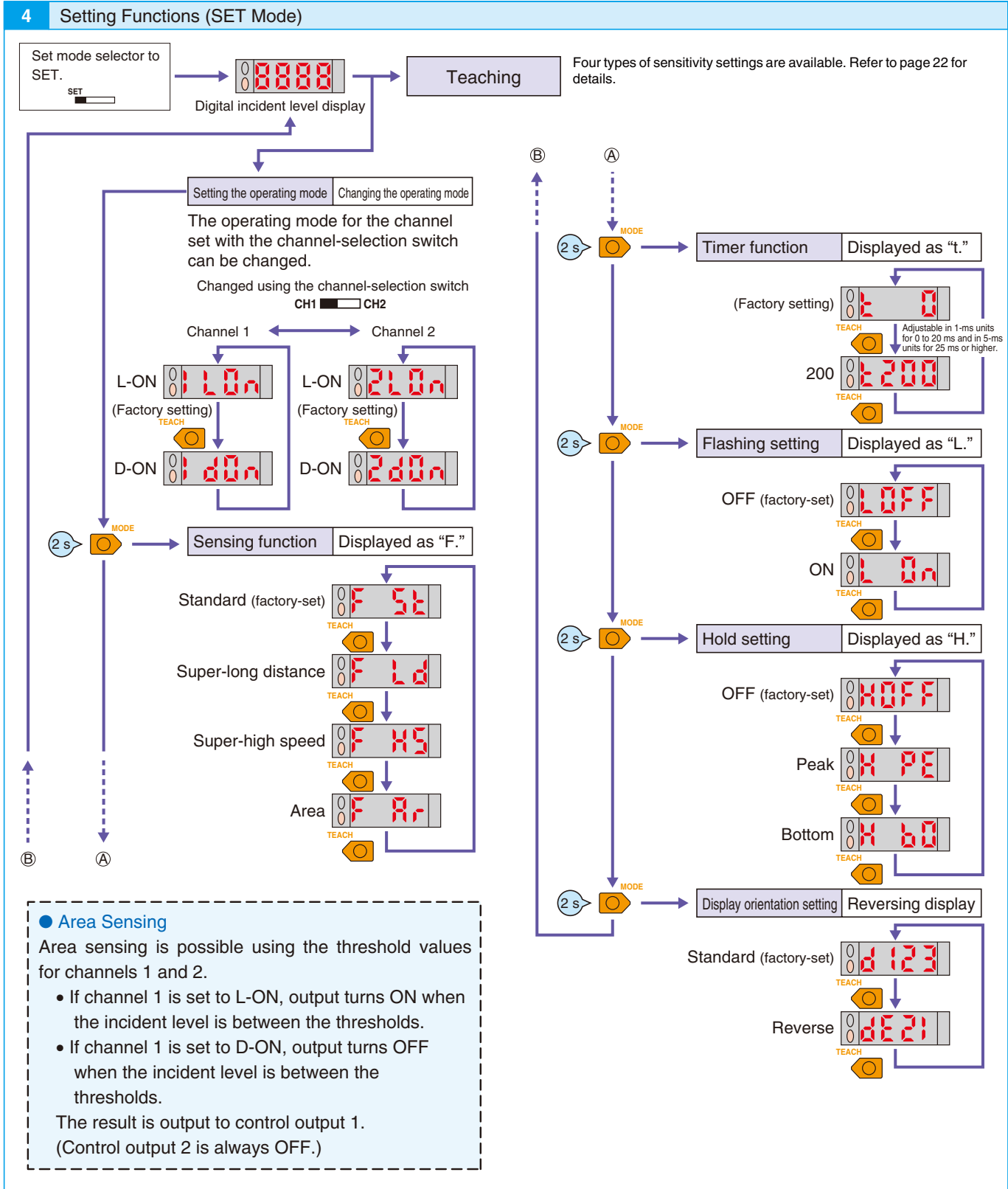

All Models





Teaching (SET Mode)

- The four types of teaching given below are available.
- Once the setting is made, the Amplifier operates according to the settings. The red level display will flash if a teaching error occurs. In that case, repeat the whole teaching procedure.

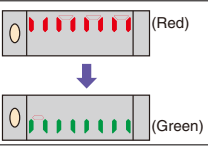

With twin-output models, switch to the channel to be adjusted using the channel-selection switch. CH1  CH2

Set the mode selector to SET to start teaching. 

Maximum Sensitivity Setting

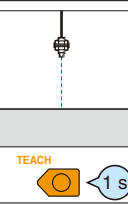

Step	Operation	
1	Set the mode selector to SET.	
2	Press the TEACH button for at least 3 seconds.	
3	Setting is complete when the level display changes from red to green. The level display will display the digital incident level later.	
4	Set to RUN mode.	

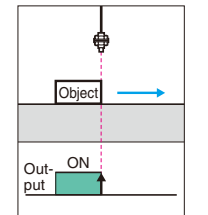
One-point Without-object Teaching

Step	Operation	
1	Set the mode selector to SET.	
2	Press the TEACH button for approximately 1 second.	
3	Teaching is complete when the red level display is lit. The level display will display the digital incident level later.	
4	Set to RUN mode.	
5	The threshold is automatically set with the object.	



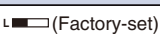

Note: If one-point teaching is not available because the difference in level is too fine, try two-point teaching.

Operating Mode Selector

Operating mode		Operation
Light-ON	L-ON	 (Factory-set)
Dark-ON	D-ON	

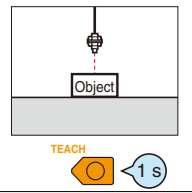

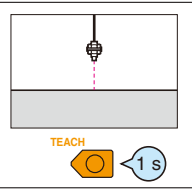
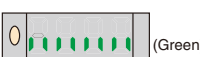

Note: There is no operating mode selector for twin-output models.

Two-point With/Without-object Teaching

Step	Operation	
1	Set the mode selector to SET.	
2	Press the TEACH button for approximately 1 second when the object is at the sensing position.	
3	The red level display is lit.	
4	Press the TEACH button for approximately 1 second with no object.	
5	Teaching is complete when the green level display is lit. The level display will display the digital incident level later.	
6	Set to RUN mode.	

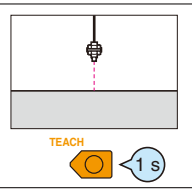
Note: The order of "with-object" and "without-object" setting steps above can be reversed.

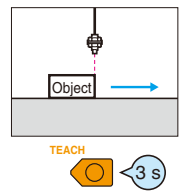
Pin-point Teaching (for Positioning)

Step	Operation	
1	Set the mode selector to SET.	
2	Press the TEACH button for approximately 1 second with no object.	
3	The red level display is lit.	
4	Place the object in the desired position, and press the TEACH button for at least 3 seconds.	
5	Teaching is complete when the green level display is lit. The level display will display the digital incident level later. (The red level display will flash if a teaching error occurs.)	
6	Set to RUN mode.	

## Safety Precautions

### ⚠ WARNING

This product is not designed or rated for ensuring safety of persons. Do not use it for such purpose.



### Precautions for Correct Use

Do not use the product in atmospheres or environments that exceed product ratings.

## Amplifiers

### ● Designing

#### Operation after Turning Power ON

The Sensor is ready to detect within 200 ms after the power supply is turned ON. If the Sensor and load are connected to separate power supplies, be sure to turn ON the Sensor first.

### ● Mounting

#### Joining and Separating Amplifiers

##### Joining Amplifiers

(1) Mount the Amplifiers one at a time onto the DIN track.

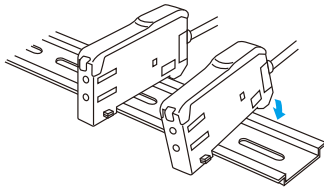

(2) Slide the Amplifiers together, line up the clips, and press the Amplifiers together until they click into place.

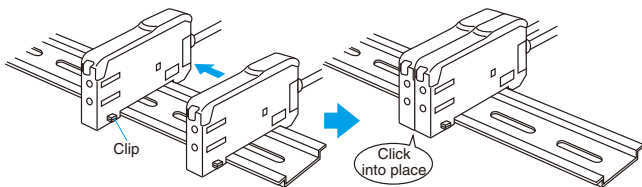

##### Separating Amplifiers

Slide Amplifiers away from each other, and remove from the DIN track one at a time. (Do not attempt to remove Amplifiers from the DIN track without separating them first.)

Note 1. The specifications for ambient temperature will vary according to the number of Amplifiers used together. For details, refer to *Ratings and Specifications*.  
2. Always turn OFF the power supply before joining or separating Amplifiers.

## Fiber Connection and Disconnection

The E3X Amplifier uses a one-touch locking mechanism. (Only the E3X-NM uses a locking button mechanism.) Connect or disconnect the fibers to or from the E3X Amplifier using the following procedures:

### (1) Connection

Open the protective cover, insert the fibers according to the fiber insertion marks on the side of the Amplifier, and lower the lock button.

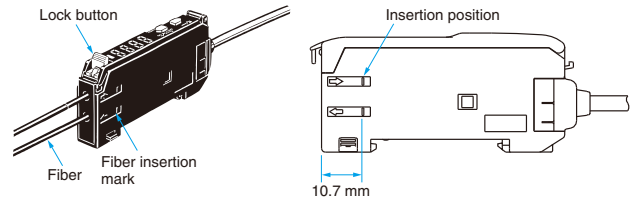

### (2) Disconnection

Remove the protective cover and raise the lock button to pull out the fiber.

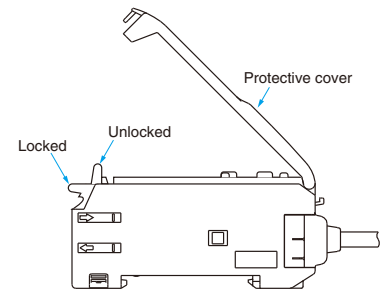

**Note: To maintain the fiber properties, confirm that the lock is released before removing the fiber.**

### (3) Precautions for Fiber Connection/Disconnection

Be sure to lock or unlock the lock button within an ambient temperature range between  $-10$  and  $40^{\circ}\text{C}$ .

### Mounting the Mobile Console Head

Leave a gap of at least 20 mm between the nearest Amplifier and the Mobile Console head.

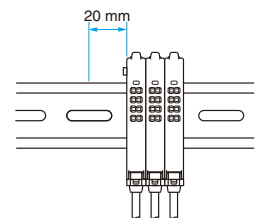

### Mounting the Mobile Console Head

With Twin-output models (E3X-DA□□TW), up to 16 channels (i.e., eight E3X-DA□□TW Amplifiers) can be set using the E3X-MC11 Mobile Console. (Operating modes and area detection, however, cannot be set.)

### ● Adjustment

#### Mutual Interference Protection Function

There may be some instability in the digital display values due to light from other sensors. If this occurs, decrease the sensitivity (i.e., increase the threshold) to perform stable detection.

#### EEPROM Writing Error

If the data is not written to the EEPROM correctly due to a power failure during teaching or static-electric noise, repeat the whole teaching procedure.

## Optical Communications

Several Amplifiers can be slid together and used in groups. Do not, however, slide the Amplifiers or attempt to remove any of the Amplifiers during operation.

## Hysteresis Adjustment

The hysteresis setting can be adjusted using the Mobile Console. Do not, however, set the hysteresis to a value lower than the factory setting. Using a setting less than the factory setting may result in incorrect operation.

## Amplifiers with Connectors

### ● Mounting

#### Mounting Connectors

- (1) Insert the Master or Slave Connector into the Amplifier until it clicks into place.

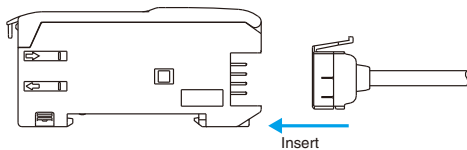

- (2) Join Amplifiers together as required after all the Master and Slave Connectors have been inserted.
- (3) Attach the stickers (provided as accessories) to the sides of Master and Slave Connectors that are not connected to other Connectors.

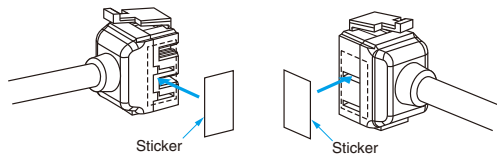

Note: Attach the stickers to the sides with grooves.

#### Removing Connectors

- (1) Slide the slave Amplifier(s) for which the Connector is to be removed away from the rest of the group.
- (2) After the Amplifier(s) has been separated, press down on the lever on the Connector and remove it. (Do not attempt to remove Connectors without separating them from other Amplifiers first.)

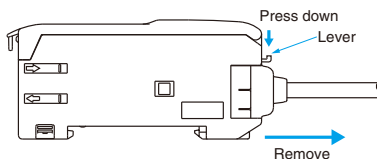

#### Mounting End Plate (PFP-M)

Depending on how it is mounted, an Amplifier may move during operation. In this case, use an End Plate. Before mounting an End Plate, remove the clip from the master Amplifier using a nipper or similar tool.

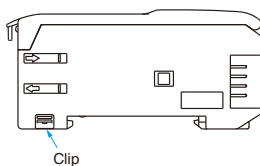

The clip can also be removed using the following mechanism, which is incorporated in the construction of the section underneath the clip.

- (1) Insert the clip to be removed into the slit underneath the clip on another Amplifier.

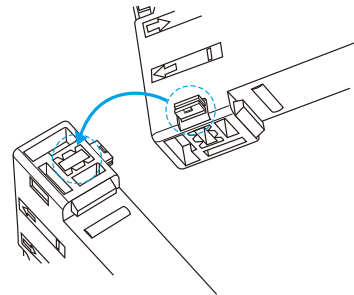

- (2) Remove the clip by rotating the Amplifier.

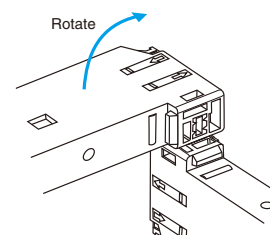

When using the E3X-DA-N with the Mobile Console, mount the End Plate in the way shown below.

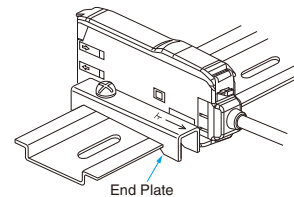

#### Pull Strengths for Connectors (Including Cables)

E3X-CN11, E3X-CN21, E3X-CN22: 30 N max.  
E3X-CN12: 12 N max.



Accessories

Operating Instructions Sticker E39-Y1

- Attach near the Sensor.
- 1 English and 1 Japanese sticker per set
- Material: Front side: Paper, Reverse side: Adhesive tape

Japanese Sticker

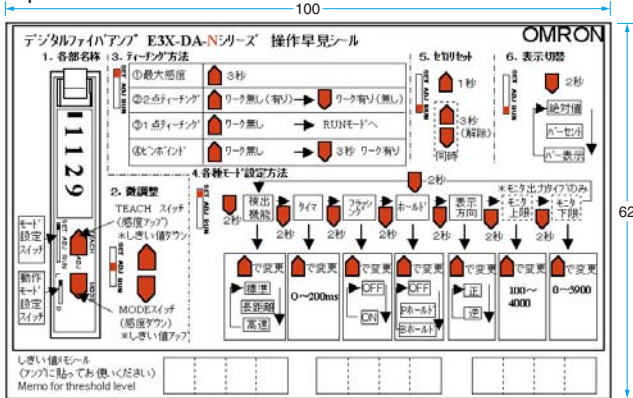

English Sticker

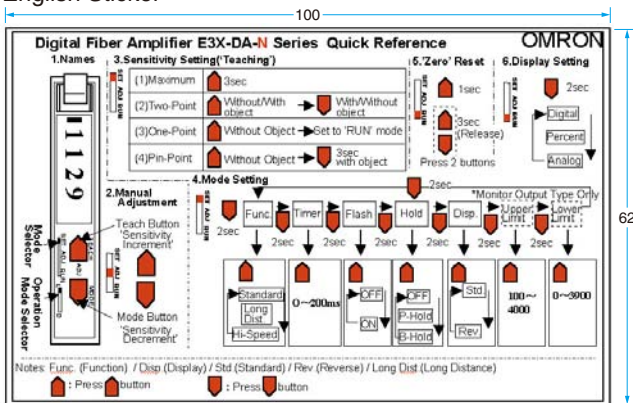

## Dimensions

### Pre-wired Amplifiers

**E3X-DA11-N**      **E3X-DAG11-N**  
**E3X-DA21-N**      **E3X-DAH11-N**  
**E3X-DAB11-N**      **E3X-DAB41-N**  
**E3X-DA41-N**      **E3X-DAG41-N**  
**E3X-DA51-N**      **E3X-DAH41-N**  
**E3X-DA11D**

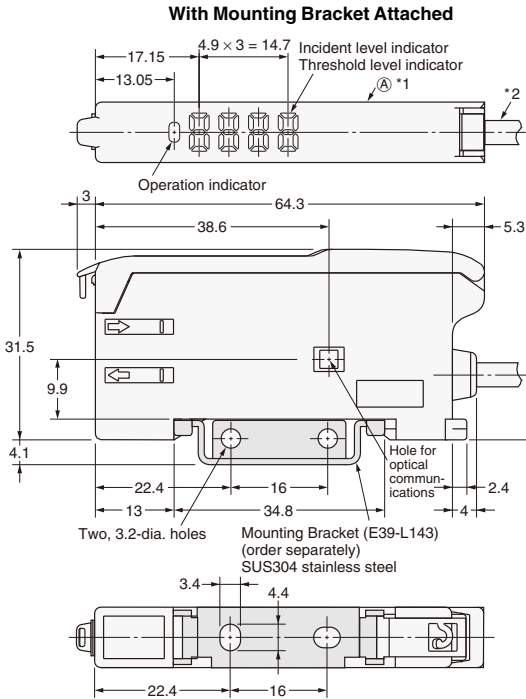
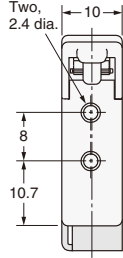
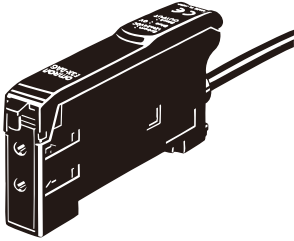

**Mounting Holes**

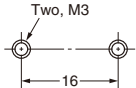

- \*1. The Mounting Bracket can also be used on side A.
- \*2. E3X-DA11-N/DA41-N/DAB11-N: 4-dia. vinyl-insulated round cable with 3 conductors (Conductor cross section: 0.2 mm<sup>2</sup>; Insulation diameter: 1.1 mm). Standard length: 2 m.  
 E3X-DA21-N/DA51-N: 4-dia. vinyl-insulated round cable with 4 conductors (Conductor cross section: 0.2 mm<sup>2</sup>; Insulation diameter: 1.1 mm). Standard length: 2 m.

### Pre-wired Amplifiers, Water-resistant Models

**E3X-DA11V**  
**E3X-DA41V**

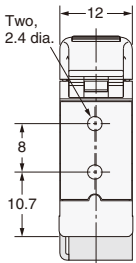
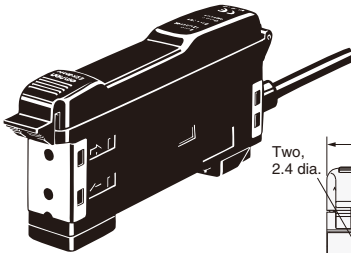

**Mounting Holes**

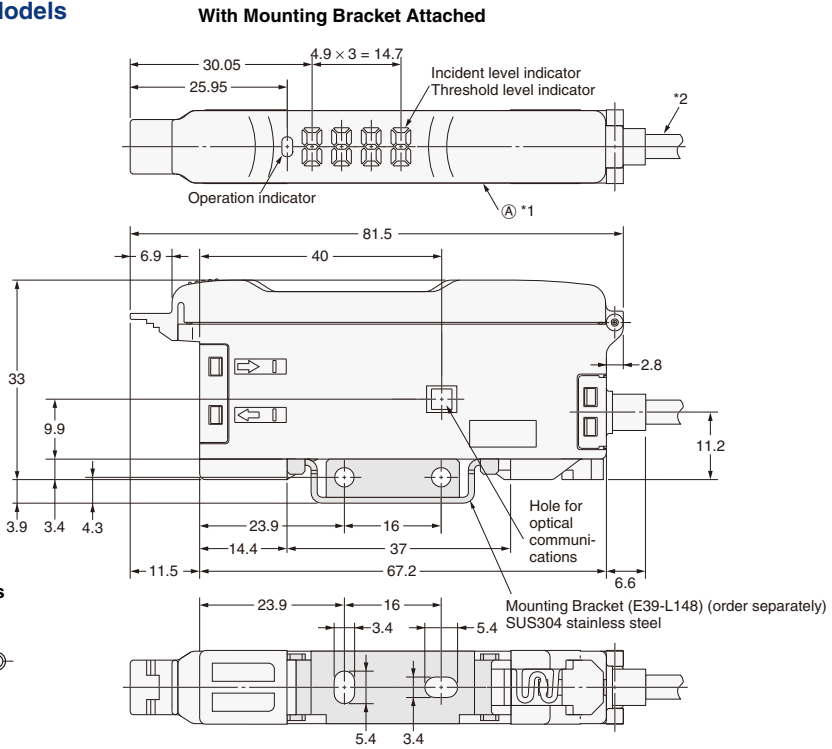
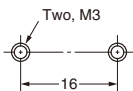

- \*1. The Mounting Bracket can also be used on side A.
- \*2. 4-dia. vinyl-insulated round cable with 3 conductors (Conductor cross section: 0.2 mm<sup>2</sup>; Insulation diameter: 1.1 mm). Standard length: 2 m.

## Pre-wired Amplifiers, Twin-output Models

E3X-DA11TW

E3X-DA41TW

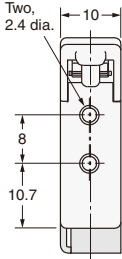
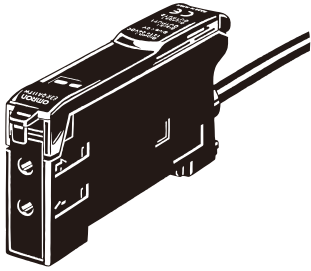

### With Mounting Bracket Attached

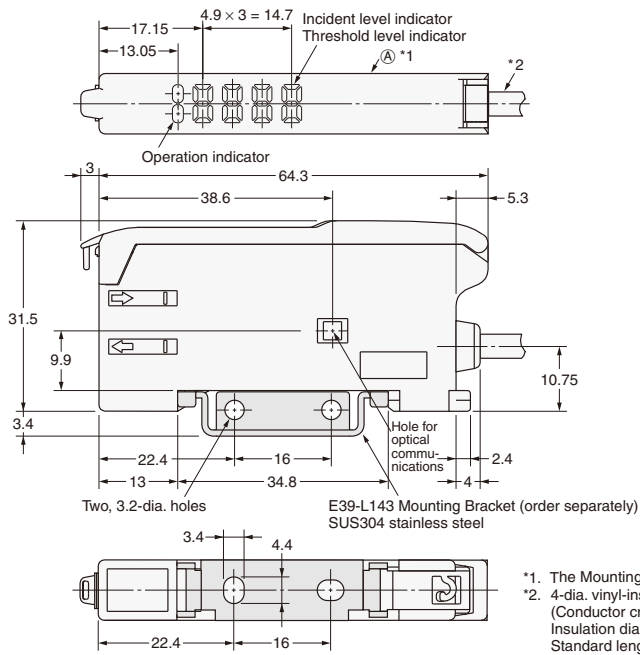

### Mounting Holes

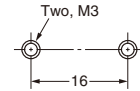

- \*1. The Mounting Bracket can also be used on side A.
- \*2. 4-dia. vinyl-insulated round cable with 4 conductors (Conductor cross section: 0.2 mm<sup>2</sup>; Insulation diameter: 1.1 mm). Standard length: 2 m.

## Amplifiers with Standard Connectors

- E3X-DA6      E3X-DAG6
- E3X-DA7      E3X-DAH6
- E3X-DA8      E3X-DAB8
- E3X-DA9      E3X-DAG8
- E3X-DAB6      E3X-DAH8
- E3X-DA6D    E3X-DA6-P

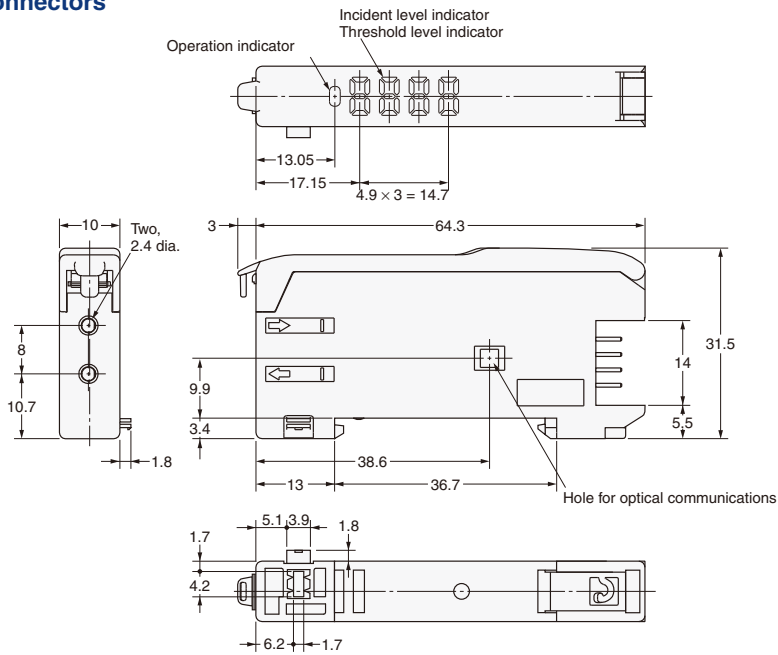
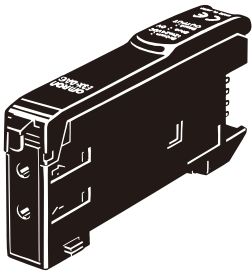

### Dimensions with Master Connector Connected

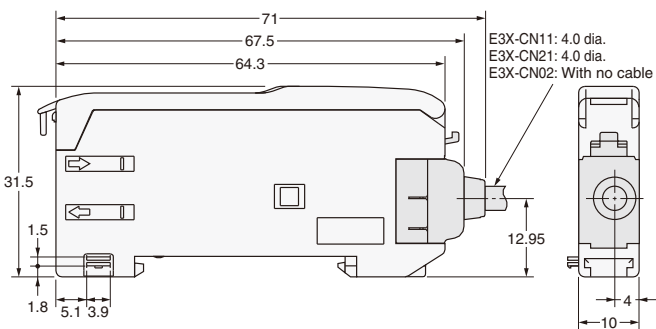

### Dimensions with Slave Connector Connected

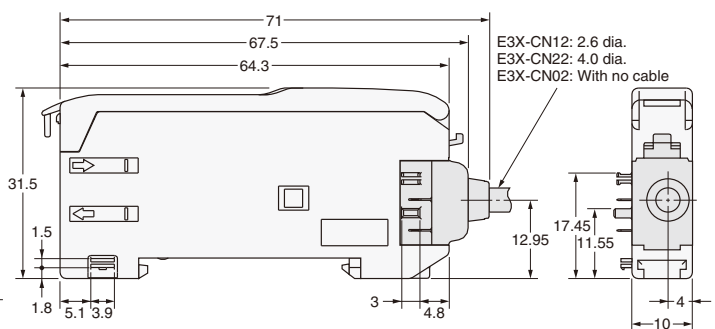

**Amplifiers with M8 Connectors, Water-resistant Models**

**E3X-DA14V**  
**E3X-DA44V**

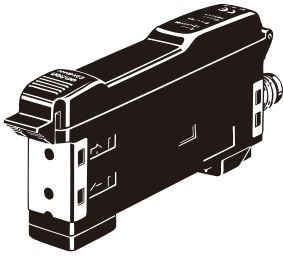

\*The Mounting Bracket can also be used on side A.

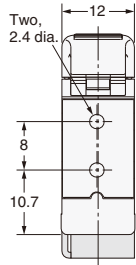

**Mounting Holes**

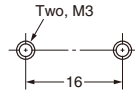

**With Mounting Bracket Attached**

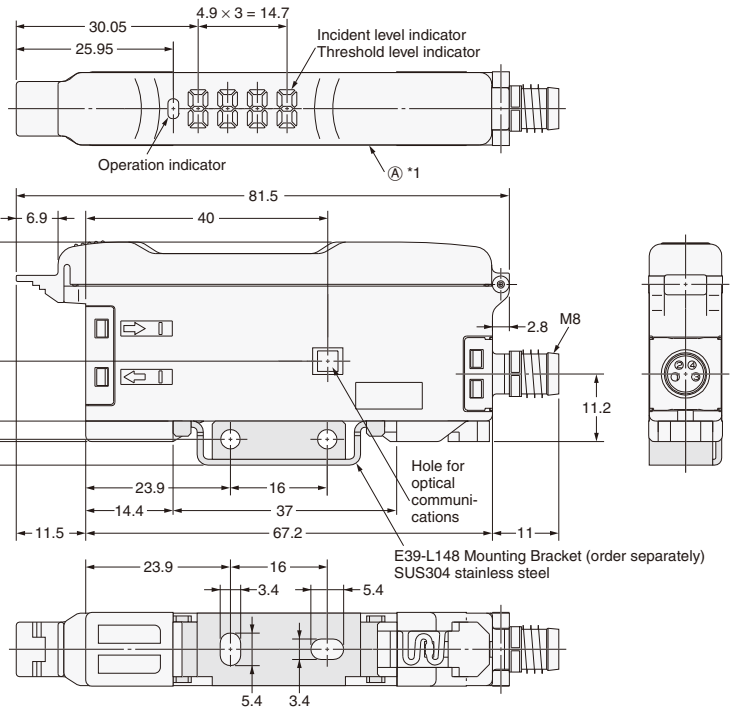

**Amplifiers with Standard Connectors, Twin-output Models**

**E3X-DA6TW**  
**E3X-DA8TW**

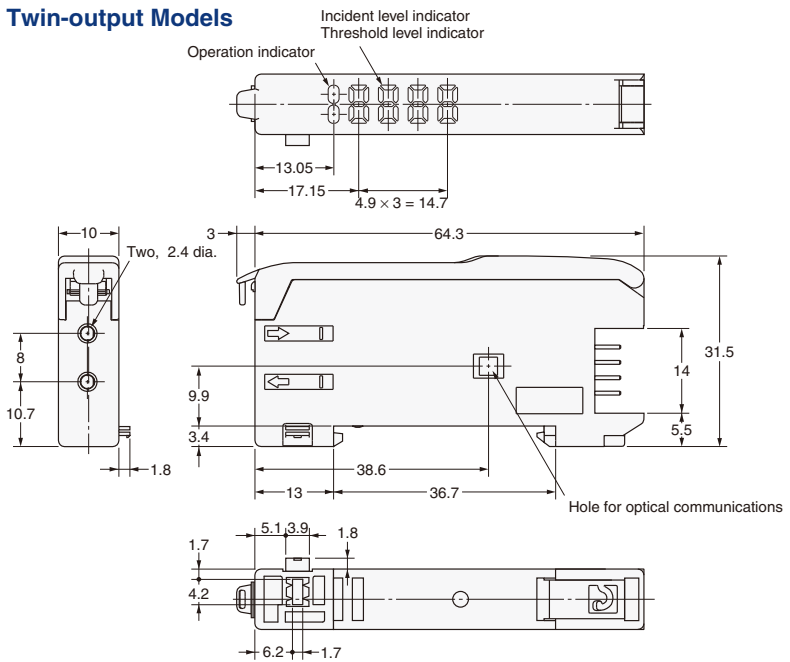
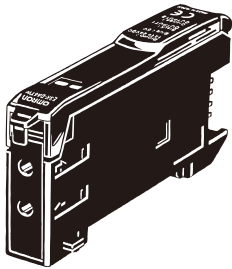

**Dimensions with Master Connector Connected**

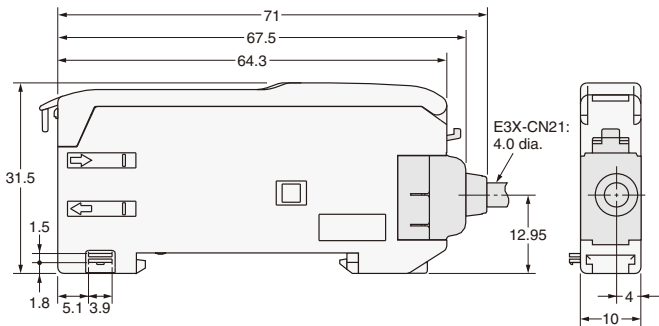

**Dimensions with Slave Connector Connected**

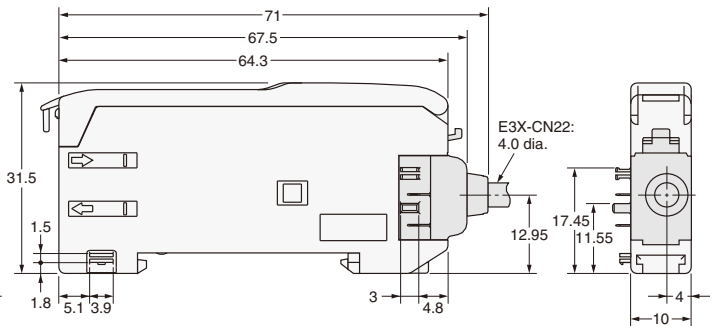

## Amplifiers with Connectors

### Master Connectors

E3X-CN11  
E3X-CN21

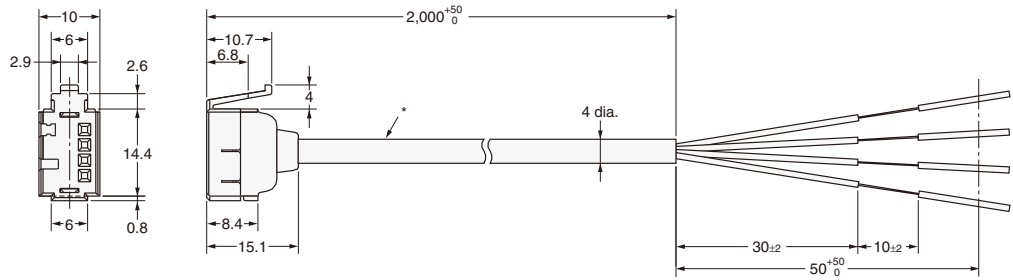
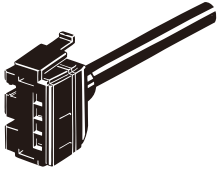

\* E3X-CN11: 4-dia. vinyl-insulated round cable with 3 conductors (Conductor cross section: 0.2 mm<sup>2</sup>; Insulation diameter: 1.1 mm).  
E3X-CN21: 4-dia. vinyl-insulated round cable with 4 conductors (Conductor cross section: 0.2 mm<sup>2</sup>; Insulation diameter: 1.1 mm).

### Slave Connectors

E3X-CN12  
E3X-CN22

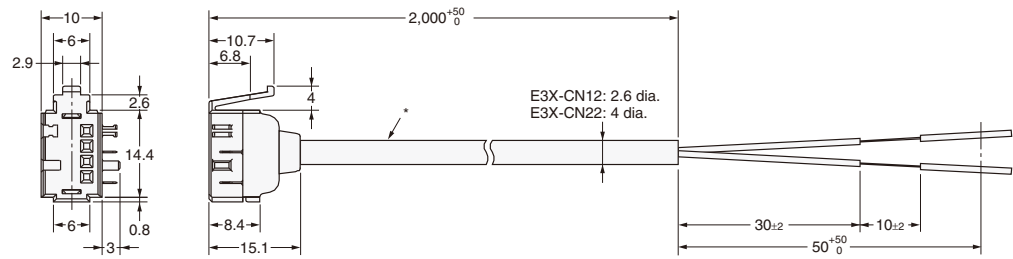
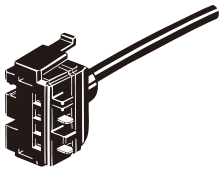

\* E3X-CN12: 2.6-dia. vinyl-insulated round cable with 1 conductor (Conductor cross section: 0.2 mm<sup>2</sup>; Insulation diameter: 1.1 mm).  
E3X-CN22: 4-dia. vinyl-insulated round cable with 2 conductors (Conductor cross section: 0.2 mm<sup>2</sup>; Insulation diameter: 1.1 mm).

## Mobile Console

E3X-MC11



### Mobile Console

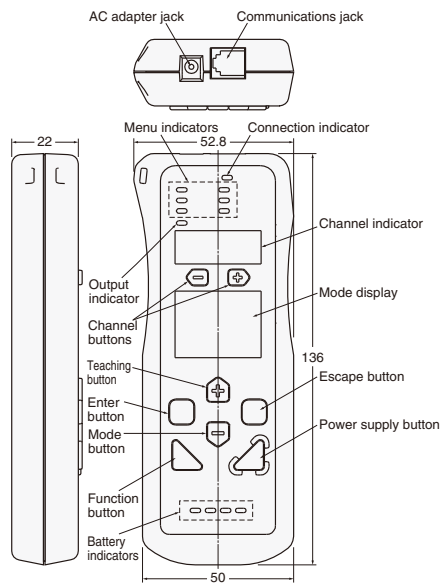

### Mobile Console Head

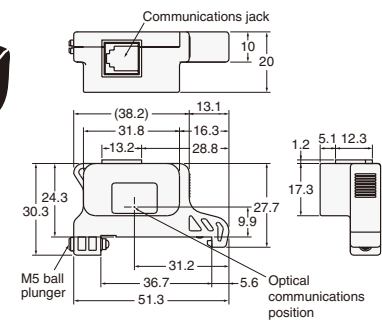

## Accessories (Order Separately)

Mounting Brackets  
End Plate

# Photoelectric Sensors Technical Guide

## General Precautions

For precautions on individual products, refer to *Safety Precautions* in individual product information.

### WARNING

These Sensors cannot be used in safety devices for presses or other safety devices used to protect human life. These Sensors are designed for use in applications for sensing workpieces and workers that do not affect safety.



### Precautions for Safe Use

To ensure safety, always observe the following precautions.

### ● Wiring

Item	Typical examples	
<p><b>Power Supply Voltage</b></p> <p>Do not use a voltage in excess of the operating voltage range. Applying a voltage in excess of the operating voltage range, or applying AC power (100 VAC or greater) to a DC Sensor may cause explosion or burning.</p>	<p>• DC Three-wire NPN Output Sensors</p>	---
<p><b>Load Short-circuiting</b></p> <p>Do not short-circuit the load. Doing so may cause explosion or burning.</p>	<p>• DC Three-wire NPN Output Sensor</p>	<p>• AC Two-wire Sensors Example: E3E2</p>
<p><b>Incorrect Wiring</b></p> <p>Do not reverse the power supply polarity or otherwise wire incorrectly. Doing so may cause explosion or burning.</p>	<p>• DC Three-wire NPN Output Sensors Example: Incorrect Polarity</p>	<p>• DC Three-wire NPN Output Sensors Example: Incorrect Polarity Wiring</p>
<p><b>Connection without a load</b></p> <p>If the power supply is connected directly without a load, the internal elements may burst or burn. Be sure to insert a load when connecting the power supply.</p>	<p>• DC Three-wire NPN Output Sensors</p>	<p>• AC 2-wire Sensors Example: E3E2 etc.</p>

### ● Operating Environment

- (1) Do not use a Sensor in an environment where there are explosive or inflammable gases.
- (2) Do not use the Sensor in environments where the cables may become immersed in oil or other liquids or where liquids may penetrate the Sensor. Doing so may result in damage from burning and fire, particularly if the liquid is flammable.

## Precautions for Correct Use

### ● Design

#### Power Reset Time

The Sensor will be ready to detect within approximately 100 ms after the power is turned ON.

If the Sensor and the load are connected to separate power supplies, turn ON the Sensor power before turning ON the load power. Any exceptions to this rule are indicated in *Safety Precautions* in individual product information.

#### Turning OFF Power

An output pulse may be generated when the power is turned OFF. It is recommended that the load or load line power be turned OFF before the Sensor power is turned OFF.

#### Power Supply Types

An unsmoothed full-wave or half-wave rectifying power supply cannot be used.

### Mutual Interference

Mutual interference is a state where an output is unstable because the Sensors are affected by light from the adjacent Sensors. The following measures can be taken to avoid mutual interference.

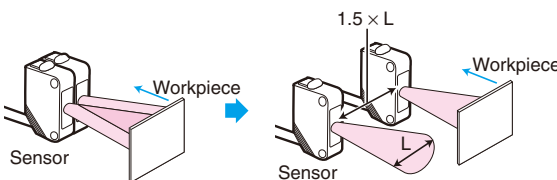
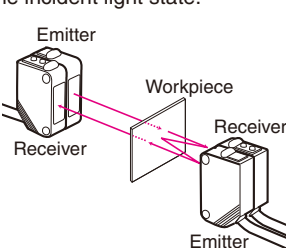
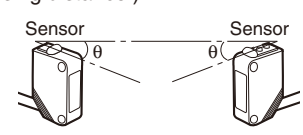
Counter-measure	Concept	Through-beam Sensors	Reflective Sensors
1	Use a Sensor with the interference prevention function.	If Sensors are mounted in close proximity, use Sensors with the interference prevention function. 10 or fewer Sensors: E3X-DA□-S, E3X-MDA, E3C-LDA Fiber Sensors Performance, however, will depend on conditions. Refer to pages E3X-DA-S/E3X-MDA and E3C-LDA. 5 or fewer Sensors: E3X-NA Fiber Sensors 2 or fewer Sensors: E3T, E3Z, E3ZM, E3ZM-C, E3S-C, E3G-L1/L3, or E3S-C Built-in Amplifier Photoelectric Sensors (except Through-beam Sensors) E3C Photoelectric Sensor with separate amplifier	
2	Install an inference prevention filter.	A mutual interference prevention polarizing filter can be installed on only the E3Z-TA to allow close-proximity mounting of up to 2 Sensors. Mutual Interference Prevention Polarizing Filter: E39-E11	---
3	Separate Sensors to distance where interference does not occur.	Check the parallel movement distance range in the catalog, verify the set distance between adjacent Sensors, and install the Sensors accordingly at a distance at least 1.5 times the parallel movement distance range.	If the workpieces move from far to near, chattering may occur in the vicinity of the operating point. For this type of application, separate the Sensors by at least 1.5 times the operating range. 
4	Alternate Emitters and Receivers.	Close mounting of Sensors is possible by alternating the Emitters with the Receivers in a zigzag fashion (up to two Sensors). However, if the workpieces are close to the Photoelectric Sensors, light from the adjacent Emitter may be received and cause the Sensor to change to the incident light state. 	---
5	Offset the optical axes.	If there is a possibility that light from another Sensor may enter the Receiver, change the position of the Emitter and Receiver, place a light barrier between the Sensors, or take other measures to prevent the light from entering the Receiver. (Light may enter even if the Sensors are separated by more than the sensing distance.)	If Sensors are mounted in opposite each other, slant the Sensors as shown in the following diagram. (This is because the Sensors may affect each other and cause output chattering even if separated by more than the Sensor sensing distance.) 
6	Adjust the sensitivity.	Lowering the sensitivity will generally help.	

# Photoelectric Sensors Technical Guide

## Noise

Countermeasures for noise depend on the path of noise entry, frequency components, and wave heights. Typical measures are as given in the following table.

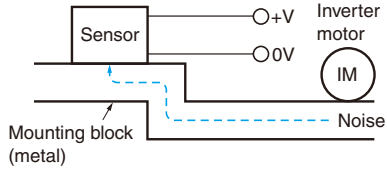
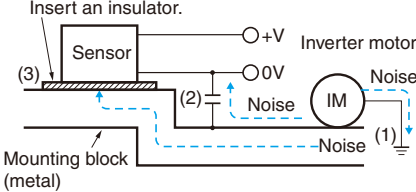
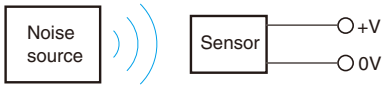
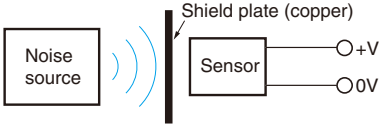
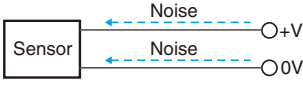
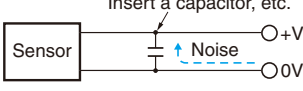
Type of noise	Noise intrusion path and countermeasure	
	Before countermeasure	After countermeasure
<b>Common mode noise (inverter noise)</b> (Common noise applied between the mounting board and the +V and 0-V lines, respectively.)	Noise enters from the noise source through the frame (metal). 	<ol style="list-style-type: none"> <li>Ground the inverter motor (to 100 Ω or less)</li> <li>Ground the noise source and the power supply (0-V side) through a capacitor (film capacitor, 0.22 μF, 630 V).</li> <li>Insert an insulator (plastic, rubber, etc.) between the Sensor and the mounting plate (metal).</li> </ol> 
<b>Radiant noise</b> (Ingress of high-frequency electromagnetic waves directly into Sensor, from power line, etc.)	Noise propagates through the air from the noise source and directly enters the Sensor. 	<ul style="list-style-type: none"> <li>Insert a shield (copper) plate between the Sensor and the noise source e.g., a switching power supply).</li> <li>Separate the noise source and the Sensor to a distance where noise does not affect operation.</li> </ul> 
<b>Power line noise</b> (Ingress of electromagnetic induction from high-voltage wires and switching noise from the switching power supply)	Noise enters from the power line. 	<ul style="list-style-type: none"> <li>Insert a capacitor (e.g., a film capacitor), noise filter (e.g., ferrite core or insulated transformer), or varistor in the power line.</li> </ul> 

## ● Wiring

### Cable

Unless otherwise indicated, the maximum length of cable extension is 100 m using wire that is 0.3 mm<sup>2</sup> or greater.

Exceptions are indicated in **Safety Precautions** in individual product information.

### Cable Tensile Strength

When wiring the cable, do not subject the cable to a tension greater than that indicated in the following table.

Cable diameter	Tensile strength
Less than 4 mm	30 N max.
4 mm or greater	50 N max.

Note: Do not subject a shielded cable or coaxial cable to tension.

### Repeated Bending

Normally, the Sensor cable should not be bent repeatedly. (For bending-resistant cable, see **Attachment to Moving Parts** on page C-4.)

### Separation from High Voltage (Wiring Method)

Do not lay the cables for the Sensor together with high-voltage lines or power lines. Placing them in the same conduit or duct may cause damage or malfunction due to induction interference. As a general rule, wire the Sensor in a separate system, use an independent metal conduit, or use shielded cable.

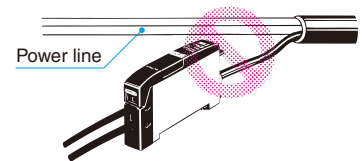

### Work Required for Unconnected Leads

Unused leads for self-diagnosis outputs or other special functions should be cut and wrapped with insulating tape to prevent contact with other terminals.



## Power Supply

When using a commercially available switching regulator, ground the FG (frame ground) and G (ground) terminals. If not grounded, switching noise in the power supply may cause malfunction.

## Example of Connection with S3D2 Sensor Controller

### DC Three-wire NPN Output Sensors

Reverse operation is possible using the signal input switch on the S3D2.

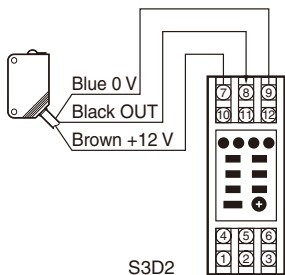

## ● Mounting

### Attachment to Moving Parts

To mount the Photoelectric Sensor to a moving part, such as a robot hand, consider using a Sensors that uses a bending-resistant cable (robot cable).

Although the bending repetition tolerance of a standard cable is approximately 13,000 times, robot cable has an excellent bending tolerance of approximately 500,000 times.

### Cable Bending Destruction Test (Tough Wire Breaking Test)

With current flowing, bending is repeated to check the number of bends until the current stops.

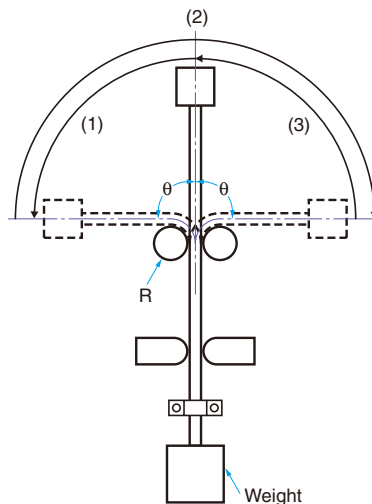

Specimen		Standard cable VR (H) 3 x18/0.12	Robot cable: Strong, conductive electrical wire 2 x 0.15 mm <sup>2</sup> , shielded
Description/conditions	Bending angle ( $\theta$ )	Left/right 90° each	Left/right 45° each
	Bending repetitions	---	60 bends/minute
	Weight	300g	200g
	Operation per bending	(1) through (3) in figure once	(1) through (3) in figure once
	Bending radius of support points (R)	5 mm	2.5 mm
Result		Approx. 13,000 times	Approx. 500,000 times

The testing conditions of the standard cable and robot cable are different.

Refer to the values in the above table to check bend-resistant performance under actual working conditions.

## Securing Fibers

The E3X Fiber Unit uses a one-touch locking mechanism. Use the following methods to attach and remove Fiber Units.

### (1) Attaching Fibers

Open the protective cover, insert the fiber up to the insertion mark on the side of the Fiber Unit, and then lower the lock lever.

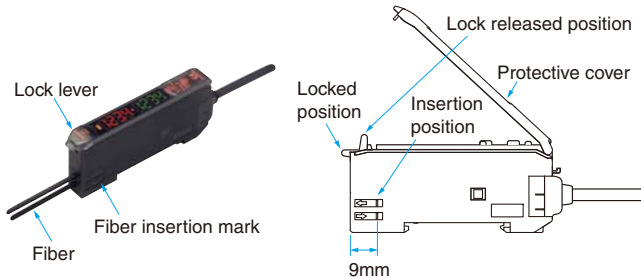

### (2) Removing Fibers

Open the protective cover, lift up the lock lever, and pull out the fibers.

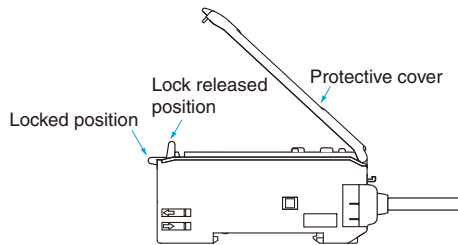

Note: 1. To maintain the fiber characteristics, make sure that the lock is released before removing the fibers.  
2. Lock and unlock the fibers at an ambient temperature of  $-10$  to  $40^{\circ}\text{C}$ .

## Adjustments

### Optical Axis Adjustment

Move the Photoelectric Sensor both vertically and horizontally and set it in the center of the range in which the operation indicator is lit or not lit. For the E3S-C, the optical axis and the mechanical axis are the same, so the optical axis can be easily adjusted by aligning the mechanical axis.

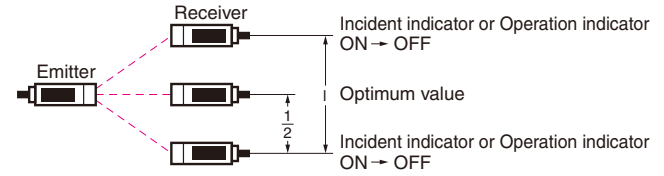

**Optical axis:** The axis from the center of the lens to the center of the beam for the Emitter and the axis from the center of the lens to the center of the reception area for the Receiver.

**Mechanical axis:** The axis perpendicular to the center of the lens.

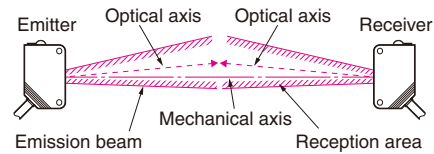

## ● Operating Environment

### Water Resistance

Do not use in water, in rain, or outside.

### Ambient Conditions

Do not use this Sensor in the following locations. Otherwise, it may malfunction or fail.

- (1) Locations exposed to excessive dust and dirt
- (2) Locations exposed to direct sunlight
- (3) Locations with corrosive gas vapors
- (4) Locations where organic solvents may splash onto the Sensor
- (5) Locations subject to vibration or shock
- (6) Locations where there is a possibility of direct contact with water, oil, or chemicals
- (7) Locations with high humidity and where condensation may result

### Environmentally Resistive Sensors

The E32-T11F/T12F/T14F/T81F-S/D12F/D82F and E3HQ can be used in locations (3) and (6) above.

### Optical Fiber Photoelectric Sensors in Explosive Gas Atmospheres

The Fiber Unit can be installed in the hazardous area, and the Amplifier Unit can be installed in a non-hazardous area.

#### <Reason>

For explosion or fire due to electrical equipment to occur, both the hazardous atmosphere and a source of ignition must be in the same location. Optical energy does not act as an ignition source, thus there is no danger of explosion or fire. The lens, case, and fiber covering are made of plastic, so this setup cannot be used if there is a possibility of contact with solvents that will corrode or degrade (e.g., cloud) the plastic.

#### <Ignition Source>

Electrical sparks or high-temperature parts that have sufficient energy to cause explosion in a hazardous atmosphere are called ignition sources.

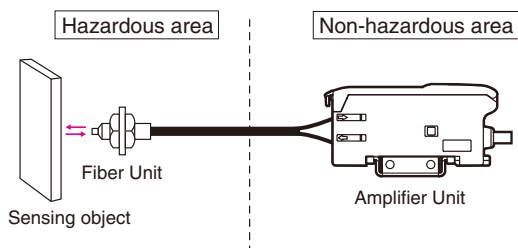

### Influence from External Electrical Fields

Do not bring a transceiver near the Photoelectric Sensor or its wiring, because this may cause incorrect operation.

## ● Maintenance and Inspection

### Points to Check When the Sensor Does Not Operate

- If the Sensor does not operate, check the following points.
  - (1) Are the wiring and connections correct?
  - (2) Are any of the mounting screws loose?
  - (3) Are the optical axis and sensitivity adjusted correctly?
  - (4) Do the sensing object and the workpiece speed satisfy the ratings and specifications?
  - (5) Are any foreign objects, such as debris or dust, adhering to the Emitter lens or Receiver lens?
  - (6) Is strong light, such as sunlight (e.g., reflected from a wall), shining on the Receiver?
  - (7) Do not attempt to disassemble or repair the Sensor under any circumstances.
  - (8) If you determine that the Sensor clearly has a failure, immediately turn OFF the power supply.

### Lens and Case

The lens and case of the Photoelectric Sensor are primarily made of plastic. Dirt should be gently wiped off with a dry cloth. Do not use thinner or other organic solvents.

- The case of the E3ZM, E3ZM-C and E3S-C is metal. The lens, however, is plastic.

## ● Accessories

### Using a Reflector (E39-R3/R37/RS1/RS2/RS3)

#### During Application

- (1) When using adhesive tape on the rear face, apply it after washing away oil and dust with detergent. The Reflector cannot be mounted if there is any oil or dirt remaining.
- (2) Do not press on the E39-RS1/RS2/RS3 with metal or a fingernail. This may weaken performance.
- (3) This Sensor cannot be used in locations where oil or chemicals may splash on the Sensor.

### M8 and M12 Connectors

- Be sure to connect or disconnect the connector after turning OFF the Sensor.
- Hold the connector cover to connect or disconnect the connector.
- Secure the connector cover by hand. Do not use pliers, otherwise the connector may be damaged.
- If the connector is not connected securely, the connector may be disconnected by vibration or the proper degree of protection of the Sensor may not be maintained.

## ● Others

### Values Given in Typical Examples

The data and values given as typical examples are not ratings and performance and do not indicate specified performance. They are rather values from samples taken from production lots, and are provided for reference as guidelines. Typical examples include the minimum sensing object, engineering data, step (height) detection data, and selection list for specifications.

### Cleaning

- Keep organic solvents away from the Sensor. Organic solvents will dissolve the surface.
- Use a soft, dry cloth to clean the Sensor.

## Read and Understand This Catalog

Please read and understand this catalog before purchasing the products. Please consult your OMRON representative if you have any questions or comments.

## Warranty and Limitations of Liability

### WARRANTY

OMRON's exclusive warranty is that the products are free from defects in materials and workmanship for a period of one year (or other period if specified) from date of sale by OMRON.

OMRON MAKES NO WARRANTY OR REPRESENTATION, EXPRESS OR IMPLIED, REGARDING NON-INFRINGEMENT, MERCHANTABILITY, OR FITNESS FOR PARTICULAR PURPOSE OF THE PRODUCTS. ANY BUYER OR USER ACKNOWLEDGES THAT THE BUYER OR USER ALONE HAS DETERMINED THAT THE PRODUCTS WILL SUITABLY MEET THE REQUIREMENTS OF THEIR INTENDED USE. OMRON DISCLAIMS ALL OTHER WARRANTIES, EXPRESS OR IMPLIED.

### LIMITATIONS OF LIABILITY

OMRON SHALL NOT BE RESPONSIBLE FOR SPECIAL, INDIRECT, OR CONSEQUENTIAL DAMAGES, LOSS OF PROFITS, OR COMMERCIAL LOSS IN ANY WAY CONNECTED WITH THE PRODUCTS, WHETHER SUCH CLAIM IS BASED ON CONTRACT, WARRANTY, NEGLIGENCE, OR STRICT LIABILITY.

In no event shall responsibility of OMRON for any act exceed the individual price of the product on which liability is asserted.

IN NO EVENT SHALL OMRON BE RESPONSIBLE FOR WARRANTY, REPAIR, OR OTHER CLAIMS REGARDING THE PRODUCTS UNLESS OMRON'S ANALYSIS CONFIRMS THAT THE PRODUCTS WERE PROPERLY HANDLED, STORED, INSTALLED, AND MAINTAINED AND NOT SUBJECT TO CONTAMINATION, ABUSE, MISUSE, OR INAPPROPRIATE MODIFICATION OR REPAIR.

## Application Considerations

### SUITABILITY FOR USE

OMRON shall not be responsible for conformity with any standards, codes, or regulations that apply to the combination of products in the customer's application or use of the product.

At the customer's request, OMRON will provide applicable third party certification documents identifying ratings and limitations of use that apply to the products. This information by itself is not sufficient for a complete determination of the suitability of the products in combination with the end product, machine, system, or other application or use.

The following are some examples of applications for which particular attention must be given. This is not intended to be an exhaustive list of all possible uses of the products, nor is it intended to imply that the uses listed may be suitable for the products:

- Outdoor use, uses involving potential chemical contamination or electrical interference, or conditions or uses not described in this catalog.
- Nuclear energy control systems, combustion systems, railroad systems, aviation systems, medical equipment, amusement machines, vehicles, safety equipment, and installations subject to separate industry or government regulations.
- Systems, machines, and equipment that could present a risk to life or property.

Please know and observe all prohibitions of use applicable to the products.

NEVER USE THE PRODUCTS FOR AN APPLICATION INVOLVING SERIOUS RISK TO LIFE OR PROPERTY WITHOUT ENSURING THAT THE SYSTEM AS A WHOLE HAS BEEN DESIGNED TO ADDRESS THE RISKS, AND THAT THE OMRON PRODUCT IS PROPERLY RATED AND INSTALLED FOR THE INTENDED USE WITHIN THE OVERALL EQUIPMENT OR SYSTEM.

## Disclaimers

### CHANGE IN SPECIFICATIONS

Product specifications and accessories may be changed at any time based on improvements and other reasons.

It is our practice to change model numbers when published ratings or features are changed, or when significant construction changes are made. However, some specifications of the product may be changed without any notice. When in doubt, special model numbers may be assigned to fix or establish key specifications for your application on your request. Please consult with your OMRON representative at any time to confirm actual specifications of purchased product.

### DIMENSIONS AND WEIGHTS

Dimensions and weights are nominal and are not to be used for manufacturing purposes, even when tolerances are shown.

### ERRORS AND OMISSIONS

The information in this catalog has been carefully checked and is believed to be accurate; however, no responsibility is assumed for clerical, typographical, or proofreading errors, or omissions.

### PERFORMANCE DATA

Performance data given in this catalog is provided as a guide for the user in determining suitability and does not constitute a warranty. It may represent the result of OMRON's test conditions, and the users must correlate it to actual application requirements. Actual performance is subject to the OMRON Warranty and Limitations of Liability.

### PROGRAMMABLE PRODUCTS

OMRON shall not be responsible for the user's programming of a programmable product, or any consequence thereof.

### COPYRIGHT AND COPY PERMISSION

This catalog shall not be copied for sales or promotions without permission.

This catalog is protected by copyright and is intended solely for use in conjunction with the product. Please notify us before copying or reproducing this catalog in any manner, for any other purpose. If copying or transmitting this catalog to another, please copy or transmit it in its entirety.

Компания «Life Electronics» занимается поставками электронных компонентов импортного и отечественного производства от производителей и со складов крупных дистрибьюторов Европы, Америки и Азии.

С конца 2013 года компания активно расширяет линейку поставок компонентов по направлению коаксиальный кабель, кварцевые генераторы и конденсаторы (керамические, пленочные, электролитические), за счёт заключения дистрибьюторских договоров

Мы предлагаем:

- Конкуренспособные цены и скидки постоянным клиентам.
- Специальные условия для постоянных клиентов.
- Подбор аналогов.
- Поставку компонентов в любых объемах, удовлетворяющих вашим потребностям.
- Приемлемые сроки поставки, возможна ускоренная поставка.
- Доставку товара в любую точку России и стран СНГ.
- Комплексную поставку.
- Работу по проектам и поставку образцов.
- Формирование склада под заказчика.
- Сертификаты соответствия на поставляемую продукцию (по желанию клиента).
- Тестирование поставляемой продукции.
- Поставку компонентов, требующих военную и космическую приемку.
- Входной контроль качества.
- Наличие сертификата ISO.

В составе нашей компании организован Конструкторский отдел, призванный помогать разработчикам, и инженерам.

Конструкторский отдел помогает осуществить:

- Регистрацию проекта у производителя компонентов.
- Техническую поддержку проекта.
- Защиту от снятия компонента с производства.
- Оценку стоимости проекта по компонентам.
- Изготовление тестовой платы монтаж и пусконаладочные работы.



Тел: +7 (812) 336 43 04 (многоканальный)

Email: [org@lifeelectronics.ru](mailto:org@lifeelectronics.ru)