



Code for Special Contacts

Nummernschlüssel für Sonderkontakte

Ordering Code

Bestellschlüssel

| | FMX | 006 | P | 102 | K |
|--|-----|-----|---|-----|---|
| Series / Baureihe | | | | | |
| FMX Coaxial contacts for cable termination / <i>Koaxialkontakt für Kabelanschluss</i> | | | | | |
| FMS Coaxial contacts for cable termination / <i>Koaxialkontakt für Kabelanschluss</i> | | | | | |
| FME Coaxial contacts for PCB termination / <i>Koaxialkontakt für Leiterplattenanschluss</i> | | | | | |
| FBM Coaxial contacts (blind mate) / <i>Koaxialkontakt (Blind mate)</i> | | | | | |
| FMP High power contacts / <i>Hochstromkontakt</i> | | | | | |
| FMV High voltage contacts / <i>Hochspannungskontakt</i> | | | | | |
| FMG Pneumatic contacts / <i>Pneumatikkontakt</i> | | | | | |
| Contact version (consecutively numbered) / Kontaktausführung (fortlaufende Nummer) | | | | | |
| Contact type / Kontaktart | | | | | |
| P Pin contact or plug, for coaxial contacts: outer conductor - pin, inner conductor - socket <i>Stiftkontakt bzw. Stecker, bei Koaxialkontakt gilt: Außenleiter - Stift, Innenleiter - Buchse</i> | | | | | |
| S Socket contact or receptacle, for coaxial contacts: outer conductor - socket, inner conductor - pin <i>Buchsenkontakt bzw. Steckdose, bei Koaxialkontakt gilt: Außenleiter - Buchse, Innenleiter - Stift</i> | | | | | |
| Plating specifications / Oberflächenspezifikation | | | | | |
| Modifications / Modifikationen | | | | | |

Series

Baureihen

FMX-Series

FMX-Serie

- Coaxial contact for cable termination
- Inner conductor for solder termination
- Outer conductor for solder termination
- Outer conductor for solder or crimp termination
- *Koaxialkontakt für Kabelanschluss*
- *Innenleiter zum Löten*
- *Außenleiter zum Löten*
- *Außenleiter zum Löten oder Crimpen*

FMP-Series

FMP-Serie

- High power contacts
- *Hochstromkontakte*

Modifications

Modifikationen

| Modifications / Modifikationen | | |
|--------------------------------|---|--|
| B | Socket with 4 slits | <i>Buchse mit vier Schlitzen</i> |
| E | With earthing spring | <i>mit Erdungsfeder</i> |
| F | Greased contacts | <i>befettete Kontakte</i> |
| K | With plastic retention clip | <i>mit Kunststoffhalterung</i> |
| M | CuBe retention clip | <i>CuBe-Halterung</i> |
| R | With knurl for secure fixing in the insulator | <i>mit Rändel für festen Sitz im Isolierkörper</i> |
| U | Narrower insertion zone for a more secure fixing in the insulator with a Cu-Be-retention clip | <i>engeres Einrastmaß für festen Sitz im Isolierkörper mit Cu-Be-Halterung</i> |
| W | With spring washer | <i>mit Federring</i> |

FMS-Series

FMS-Serie

- Coaxial contact for cable termination
- Inner conductor for crimp or solder termination
- Crimp Snap-In System
- Outer conductor for solder or crimp termination
- *Koaxialkontakt für Kabelanschluss*
- *Innenleiter zum Crimpen oder Löten*
- *Crimp Snap-In System*
- *Außenleiter zum Löten oder Crimpen*

FMV-Series

FMV-Serie

- High voltage contacts
- *Hochspannungskontakte*

FME-Series

FME-Serie

- Coaxial contact for PCB termination
- *Koaxialkontakt für Leiterplattenanschluss*

FBM-Series

FBM-Serie

- Coaxial contact for D-Sub / Blind mate / For hidden mounting, e.g. in drawers for frequencies up to 3.5 GHz.
- *Koaxialkontakte für D-Sub / Blind mate / Für verdecktes Stecken z. B. bei Einschubschächten für Frequenzen bis zu 3,5 GHz*

FMG-Series

FMG-Serie

- Pneumatic contacts
- *Pneumatikkontakte*



Plating Specifications for the Series FMX, FMS, FME and FBM

Oberflächenspezifikationen für die Baureihen FMX, FMS, FME und FBM

| | Mating Area / <i>Steckbereich</i> | | Termination Area / <i>Anschlussbereich</i> | | RoHS | Comment / <i>Bemerkung</i> |
|-----|--|--|--|--|------|---------------------------------------|
| | Outer Conductor / <i>Außenleiter</i> | Inner Conductor / <i>Innenleiter</i> | Inner Conductor / <i>Innenleiter</i> | Outer Conductor / <i>Außenleiter</i> | | |
| 101 | 0,2 µm (8 microinches) Au over Ni / <i>Au über Ni</i> | 0,2 µm (8 microinches) Au over Ni / <i>Au über Ni</i> | 0,2 µm (8 microinches) Au over Ni / <i>Au über Ni</i> | 5 µm (200 microinches) Sn over Ni / <i>Sn über Ni</i> | • | Low cost |
| 102 | 0,8 µm (30 microinches) Au over Ni / <i>Au über Ni</i> | 1,3 µm (50 microinches) Au over Ni / <i>Au über Ni</i> | 1,3 µm (50 microinches) Au over Ni / <i>Au über Ni</i> | 0,2 µm (8 microinches) Au over Ni / <i>Au über Ni</i> | • | Standard |
| 108 | 0,8 µm (30 microinches) Au over Ni / <i>Au über Ni</i> | 1,3 µm (50 microinches) Au over Ni / <i>Au über Ni</i> | 1,3 µm (50 microinches) Au over Ni / <i>Au über Ni</i> | 5 µm (200 microinches) Sn over Ni / <i>Sn über Ni</i> | • | |
| 111 | 0,8 µm (30 microinches) Au over Cu / <i>Au über Cu</i> | 1,3 µm (50 microinches) Au over Cu / <i>Au über Cu</i> | 1,3 µm (50 microinches) Au over Cu / <i>Au über Cu</i> | 0,2 µm (8 microinches) Au over Cu / <i>Au über Cu</i> | • | Non-magnetic |
| 128 | 5 µm (200 microinches) Au over Cu / <i>Au über Cu</i> | 5 µm (200 microinches) Au over Cu / <i>Au über Cu</i> | 5 µm (200 microinches) Au over Cu / <i>Au über Cu</i> | 5 µm (200 microinches) Sn over Ag over Cu / <i>Sn über Ag über Cu</i> | • | Non-magnetic |
| 154 | 0,8 µm (30 microinches) Au over Ni / <i>Au über Ni</i> | 1,3 µm (50 microinches) Au over Ni / <i>Au über Ni</i> | 1,3 µm (50 microinches) Au over Ni / <i>Au über Ni</i> | 0,2 µm (8 microinches) Au over Ni / <i>Au über Ni</i> | • | CuBe design <i>CuBe-Ausführung</i> |
| 201 | 0,1 µm (4 microinches) Au over NiP / <i>Au über NiP</i> | 0,1 µm (4 microinches) Au over NiP / <i>Au über NiP</i> | 0,1 µm (4 microinches) Au over NiP / <i>Au über NiP</i> | 5 µm (200 microinches) Sn over Ni / <i>Sn über Ni</i> | • | AuroPur / Tin |
| 202 | 0,1 µm (4 microinches) Au over NiP / <i>Au über NiP</i> | 0,1 µm (4 microinches) Au over NiP / <i>Au über NiP</i> | 0,1 µm (4 microinches) Au over NiP / <i>Au über NiP</i> | 0,2 µm (8 microinches) Au over Ni / <i>Au über Ni</i> | • | AuroPur |

Further platings on request / *Weitere Oberflächen auf Anfrage*

Plating Specifications (High Power Contacts)

Oberflächenspezifikationen (Hochstromkontakte)

| | Mating Area / <i>Steckbereich</i> | | Termination Area / <i>Anschlussbereich</i> | | RoHS | Comment / <i>Bemerkung</i> |
|-----|------------------------------------|---|--|--|------|---|
| | Material <i>Material</i> | Plating <i>Oberfläche</i> | Material <i>Material</i> | Plating <i>Oberfläche</i> | | |
| 103 | Cu-alloy <i>Kupferlegierung</i> | 0,8 µm (30 microinches) Au over Ni / <i>Au über Ni</i> | Cu-alloy <i>Kupferlegierung</i> | 0,2 µm (8 microinches) Au over Ni / <i>Au über Ni</i> | • | Standard |
| 104 | Cu-alloy <i>Kupferlegierung</i> | 0,8 µm (30 microinches) Au over Ni / <i>Au über Ni</i> | Cu-alloy <i>Kupferlegierung</i> | 5 µm (200 microinches) Sn over Ni / <i>Sn über Ni</i> | • | Standard |
| 105 | Cu-alloy <i>Kupferlegierung</i> | 0,2 µm (8 microinches) Au over Ni / <i>Au über Ni</i> | Cu-alloy <i>Kupferlegierung</i> | 5 µm (200 microinches) Sn over Ni / <i>Sn über Ni</i> | • | Low cost |
| 106 | Cu-alloy <i>Kupferlegierung</i> | 0,2 µm (8 microinches) Au over Ni / <i>Au über Ni</i> | Cu-alloy <i>Kupferlegierung</i> | 0,2 µm (8 microinches) Au over Ni / <i>Au über Ni</i> | • | Low cost crimp connection <i>Low cost Crimpanschluss</i> |
| 113 | Cu-alloy <i>Kupferlegierung</i> | 1,3 µm (50 microinches) Au over Ni / <i>Au über Ni</i> | Cu-alloy <i>Kupferlegierung</i> | 5 µm (200 microinches) Sn over Ni / <i>Sn über Ni</i> | • | |
| 133 | Cu-alloy <i>Kupferlegierung</i> | 5 µm (200 microinches) Au over Cu / <i>Au über Cu</i> | Cu-alloy <i>Kupferlegierung</i> | 5 µm (200 microinches) Sn over Ag over Cu / <i>Sn über Ag über Cu</i> | • | Non-magnetic |
| 140 | Cu-alloy <i>Kupferlegierung</i> | 0,2 µm (8 microinches) Au over Ni / <i>Au über 2 µm Ni</i> | Cu-alloy <i>Kupferlegierung</i> | 1 - 1,5 µm (40 - 60 microinches) Sn over Ni / <i>Sn über Ni</i> | • | Low cost press-fit <i>Low cost Einpresstechnik</i> |
| 141 | Cu-alloy <i>Kupferlegierung</i> | 0,8 µm (30 microinches) Au over Ni / <i>Au über Ni</i> | Cu-alloy <i>Kupferlegierung</i> | 1 - 1,5 µm (40 - 60 microinches) Sn over Ni / <i>Sn über Ni</i> | • | Standard press-fit <i>Standard Einpresstechnik</i> |
| 187 | Cu-alloy <i>Kupferlegierung</i> | 0,8 µm (30 microinches) Au over Cu / <i>Au über Cu</i> | Cu-alloy <i>Kupferlegierung</i> | 0,2 µm (8 microinches) Au over Cu / <i>Au über Cu</i> | • | Intermodulation sensitive |
| 203 | Cu-alloy <i>Kupferlegierung</i> | 0,1 µm (4 microinches) Au over NiP / <i>Au über NiP</i> | Cu-alloy <i>Kupferlegierung</i> | 5 µm (200 microinches) Sn over Ni / <i>Sn über Ni</i> | • | AuroPur / Tin |
| 204 | Cu-alloy <i>Kupferlegierung</i> | 0,1 µm (4 microinches) Au over NiP / <i>Au über NiP</i> | Cu-alloy <i>Kupferlegierung</i> | 0,2 µm (8 microinches) Au over Ni / <i>Au über Ni</i> | • | AuroPur |

Further platings on request / *Weitere Oberflächen auf Anfrage*

Wire Cross-section

Leiterquerschnitt

| AWG | Wire Cross-section / <i>Leiterquerschnitt</i> | | | | | | | | | | |
|---|---|----------|-----------|-----------|-----------|-----------|-----------|-----------|-----------|-----------|-----------|
| | 8 | 10 | 12 | 14 | 16 | 18 | 20 | 22 | 24 | 26 | 28 |
| Wire Construction, n x conductor diameter <i>Leiteraufbau, n x Drahtdurchmesser</i> | 133 x 0,29 | 37 x 0,4 | 19 x 0,46 | 19 x 0,36 | 19 x 0,29 | 19 x 0,25 | 19 x 0,20 | 19 x 0,16 | 19 x 0,13 | 19 x 0,10 | 19 x 0,08 |
| Metrical cross-section (mm ²) <i>metrischer Querschnitt (mm²)</i> | 8,60 | 4,75 | 3,09 | 1,95 | 1,23 | 0,96 | 0,62 | 0,38 | 0,24 | 0,16 | 0,09 |
| Wire outer diameter <i>Außendurchmesser Leiter</i> | 3,73 | 2,92 | 2,37 | 1,85 | 1,47 | 1,25 | 0,94 | 0,79 | 0,61 | 0,51 | 0,41 |

Coaxial Contacts

Koaxialkontakte

Technical Data

Technische Daten

Mechanical Data

Mechanische Daten

| Mechanical Data Mechanische Daten | |
|---|--------------------------------------|
| Mating and unmating force (pair of contacts) Steck- und Ziehkräfte (Kontaktpaar) | ≤ 7 N |
| Recommended temperature range Empfohlener Temperaturbereich | -55 °C bis 135 °C (-67 °F to 275 °F) |
| Mating cycles (Standard) Steckzyklen (Standard) | ≥ 500 |
| Mating cycles (low cost) Steckzyklen (Low cost) | ≥ 200 |

Electrical Data

Elektrische Daten

| Electrical Data Elektrische Daten | |
|--|---------------|
| Characteristic impedance Wellenwiderstand | 50 Ω / 75 Ω |
| Insulation resistance Isolationswiderstand | ≥ 10 G Ω |
| Contact resistance inner conductor Durchgangswiderstand Innenleiter | ≤ 2,7 mΩ |
| Contact resistance outer conductor Durchgangswiderstand Außenleiter | ≤ 2,7 mΩ |
| Dielectric withstanding voltage Spannungsfestigkeit | 750 V / 50 Hz |
| Working voltage Betriebsspannung | 250 Vrms |
| Current rating (DC) Max. Kontaktstrom (DC) | 2 A |

Materials

Materialien

| Materials Materialien | |
|--------------------------------|--------------------------|
| Outer conductor Außenleiter | Cu alloy Cu Legierung |
| Inner conductor Innenleiter | Cu alloy Cu Legierung |
| Retaining clip Halteclip | Cu alloy Cu Legierung |
| Insulators Isolierteile | PTFE / PBTP / PI |

VSWR Measurements (Examples)

VSWR Messungen (Beispiele)

VSWR

VSWR

The ratio of the maximum to minimum value of the voltage amplitude on a lead is known as the VSWR value. The quotient is a measurement of the quality of the adaptation or of the fluctuation of the resulting voltage surge. In the case of a mismatch, the outward wave is reflected onto the contact point. By superimposing the outward and return waves, a greater difference is obtained between the maximum and minimum voltage than for the outward wave. The VSWR value is 1.0 for a perfect adaptation. The reciprocal value is known as the adaptation factor m.

Das Verhältnis von Maximal- zu Minimalwert der Spannungsamplitude auf einer Leitung wird mit VSWR Wert bezeichnet. Der Quotient ist ein Maß für die Qualität der Anpassung bzw. der Welligkeit der resultierenden Spannungswelle. Bei Fehlanpassung wird die hinlaufende Welle an der Kontaktstelle reflektiert. Durch die Überlagerung der hinlaufenden und der rücklaufenden Spannungswelle ergibt sich für die resultierende ein größerer Unterschied zwischen der maximalen und der minimalen Spannungsamplitude als bei der hinlaufenden Welle. Der VSWR-Wert ist im Idealfall der Anpassung gleich 1.0, den Kehrwert bezeichnet man als Anpassungsfaktor m.

r: Reflection factor / Reflexionsfaktor

m: Adaptation factor / Anpassungsfaktor

a: Return loss / Rückflußdämpfung

VSWR: Voltage standing wave ratio / Stehwellenverhältnis

$$VSWR = \frac{U_{\max}}{U_{\min}} = \frac{1+r}{1-r} \quad r = \frac{VSWR - 1}{VSWR + 1} \quad m = \frac{1}{VSWR} \quad a = -20 \lg \frac{VSWR + 1}{VSWR - 1}$$

FMS001P102 / ...S102 (Straight Contacts / gerade Kontakte)

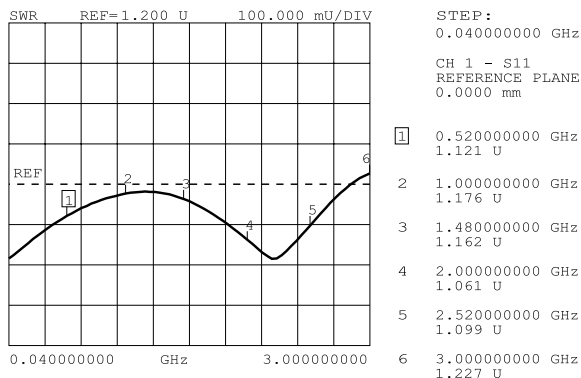

FMS015P102/ ...S102 (Right Angled Contacts / abgewinkelte Kontakte)

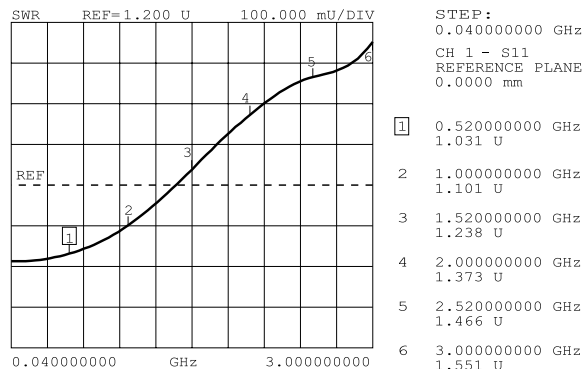

FBM004P170 / ...S170 (Straight Contacts / gerade Kontakte)

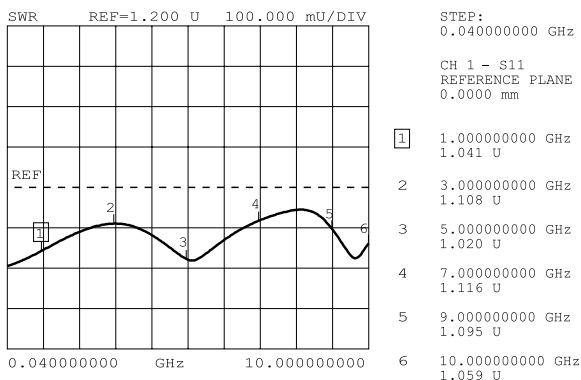

FMX006P102 / ...S102 (Straight Contacts / gerade Kontakte)

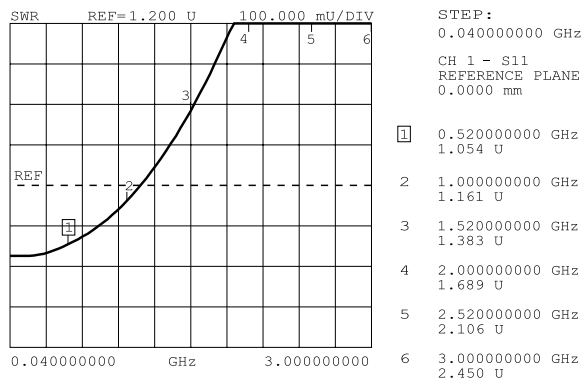



Coaxial Contacts, Mating Area Dimensions, Pin Diameter 1 mm (0.039")

Koaxialkontakte, Abmessungen Steckbereich, Pindurchmesser 1 mm

Plug

Stecker

Socket

Buchse

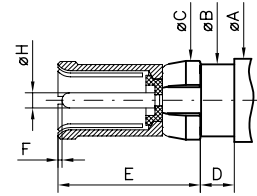
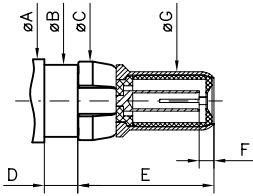

| | Plug / <i>Stecker</i> | | Socket / <i>Buchse</i> | | | |
|-----------|-----------------------|------------------------|------------------------|-----------------|-----------------|-----------------|
| | min | max. | min | | max. | |
| | | | Modi. U* | | Modi. U* | |
| ØA | — | 5,50 (0.217) | — | | 5,50 (0.217) | |
| ØB | 4,75 (0.187) | 4,80 (0.189) | 4,75 (0.187) | | 4,80 (0.189) | |
| ØC | 5,00 (0.197) | 5,40 (0.213) | 5,00 (0.197) | | 5,40 (0.213) | |
| D | 2,25 (0.089) | 2,45 (0.096) | 2,25 (0.089) | 2,10 (0.083) | 2,45 (0.096) | 2,25 (0.089) |
| E | — | 9,00 (0.354) | — | | 9,5 (0.374) | |
| F | — | approx. 1,0 ca. 1,0 | 0,10 (0.004) | | 0,50 (0.020) | |
| ØG | 3,83 (0.151) | 3,87 (0.152) | — | | — | |
| ØH | — | — | 0,98 (0.039) | | 1,02 (0.040) | |

Modification U* please see page 26

Modifikation U siehe Seite 26*



FMX Coaxial Contacts, 50 Ohm, Straight Cable Termination

FMX Koaxialkontakte, 50 Ohm, gerader Kabelanschluss

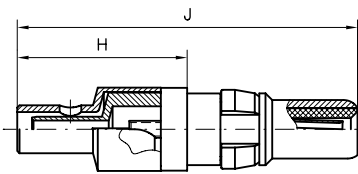

| | |
|---------------------------------------|--|
| Inner Conductor <i>Innenleiter</i> | Outer Conductor <i>Außenleiter</i> |
| Solder termination <i>Löten</i> | Crimp or solder termination <i>Crimpen oder Löten</i> |

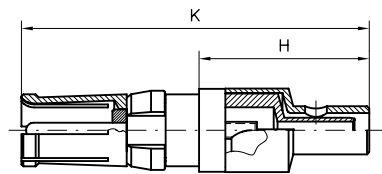

| Order Number Plug <i>Bestellnummer Stecker</i> | Type <i>Ausführung</i> | Platings / <i>Oberflächen</i> | | | | Suitable Cables RG- <i>Verwendbare Kabel RG-</i> | Order Number Receptacles <i>Bestellnummer Steckdose</i> |
|---|---------------------------|---------------------------------------|---------------------------------------|---|---------------------------------------|---|--|
| | | Mating Area <i>Steckbereich</i> | | Termination Area <i>Anschlussbereich</i> | | | |
| | | Inner Conductor <i>Innenleiter</i> | Outer Conductor <i>Außenleiter</i> | Inner Conductor <i>Innenleiter</i> | Outer Conductor <i>Außenleiter</i> | | |
| FMX005P102 | standard | 1,3 µm Au | 0,8 µm Au | 1,3 µm Au | 0,2 µm Au | 178BU | FMX005S102 |
| FMX005P101 | low cost | 0,2 µm Au | 0,2 µm Au | 0,2 µm Au | 5 µm Sn | 196AU, 404U | FMX005S101 |
| FMX005P202 | standard | AuroPur | AuroPur | AuroPur | 0,2 µm Au | 178BU | FMX005S202 |
| FMX005P201 | low cost | AuroPur | AuroPur | AuroPur | 5 µm Sn | 196AU, 404U | FMX005S201 |
| FMX006P102* | standard | 1,3 µm Au | 0,8 µm Au | 1,3 µm Au | 0,2 µm Au | 174U | FMX006S102* |
| FMX006P101* | low cost | 0,2 µm Au | 0,2 µm Au | 0,2 µm Au | 5 µm Sn | 188AU, 316U | FMX006S101* |
| FMX007P102* | standard | 1,3 µm Au | 0,8 µm Au | 1,3 µm Au | 0,2 µm Au | 180BU | FMX007S102* |
| FMX007P101* | low cost | 0,2 µm Au | 0,2 µm Au | 0,2 µm Au | 5 µm Sn | | FMX007S101* |
| FMX008P102 | standard | 1,3 µm Au | 0,8 µm Au | 1,3 µm Au | 0,2 µm Au | 58CU, 141AU | FMX008S102 |
| FMX008P101 | low cost | 0,2 µm Au | 0,2 µm Au | 0,2 µm Au | 5 µm Sn | | FMX008S101 |
| FMX012P102 | standard | 1,3 µm Au | 0,8 µm Au | 1,3 µm Au | 0,2 µm Au | 316U double braided <i>doppelt geschirmt</i> | FMX012S102 |
| FMX012P101 | low cost | 0,2 µm Au | 0,2 µm Au | 0,2 µm Au | 5 µm Sn | | FMX012S101 |

Other platings on request / *Andere Oberflächen auf Anfrage*
Tools from page 94 onwards / *Werkzeuge ab Seite 94 ff.*

8 microinches = $\approx 0,2 \mu\text{m}$
30 microinches = $\approx 0,8 \mu\text{m}$

50 microinches = $\approx 1,3 \mu\text{m}$
200 microinches = $\approx 5 \mu\text{m}$

* Deep-drawn crimp ferrule without inspection hole, please see illustration on page 32.
* *Tiefgezogene Crimphülse ohne Inspektionsbohrung, siehe Darstellung auf Seite 32.*

Dimensions

Abmessungen

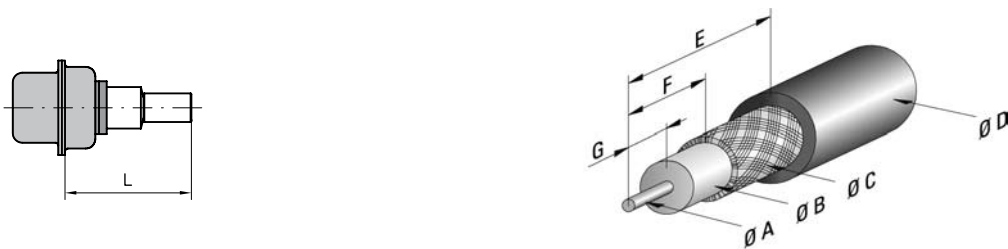

| Order Number <i>Bestellnummer</i> | Ø A max. | Ø B max. | Ø C max. | Ø D max. | E | F | G | H | J | K | L |
|--------------------------------------|-----------------|----------------|----------------|----------------|----------------|----------------|----------------|-----------------|-----------------|-----------------|-----------------|
| FMX005... | 0,85 (0.033) | 1,2 (0.047) | 1,4 (0.055) | 2,3 (0.091) | 9,5 (0.374) | 5,0 (0.197) | 3,0 (0.118) | 11,2 (0.441) | 22,5 (0.886) | 23,0 (0.906) | 16,7 (0.657) |
| FMX006... | 0,85 (0.033) | 1,9 (0.075) | 2,3 (0.091) | 3,2 (0.126) | 9,5 (0.374) | 5,0 (0.197) | 3,0 (0.118) | 11,2 (0.441) | 22,5 (0.886) | 23,0 (0.906) | 16,7 (0.657) |
| FMX007... | 0,85 (0.033) | 2,8 (0.110) | 3,1 (0.122) | 4,5 (0.177) | 9,5 (0.374) | 5,0 (0.197) | 3,0 (0.118) | 11,2 (0.441) | 22,5 (0.886) | 23,0 (0.906) | 16,7 (0.657) |
| FMX008... | 1,0 (0.039) | 3,0 (0.118) | 3,6 (0.142) | 5,2 (0.205) | 9,5 (0.374) | 5,0 (0.197) | 3,0 (0.118) | 13,6 (0.535) | 26,3 (1.035) | 26,8 (1.055) | 19,0 (0.748) |
| FMX012... | 0,85 (0.033) | 1,9 (0.075) | 2,7 (0.106) | 3,2 (0.126) | 9,5 (0.374) | 5,0 (0.197) | 3,0 (0.118) | 12,2 (0.480) | 23,5 (0.925) | 24,0 (0.945) | 17,3 (0.681) |



FMX Coaxial Contacts, 50 Ohm, Right Angled Cable Termination

FMX Koaxialkontakte, 50 Ohm, abgewinkelter Kabelanschluss

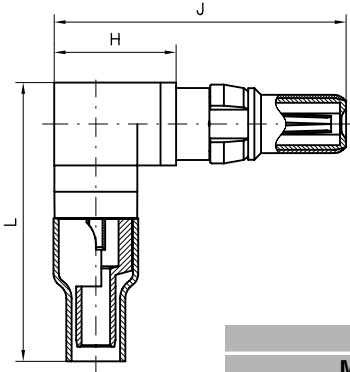

| | |
|--|---|
| Inner Conductor <i>Innenleiter</i> | Outer Conductor <i>Außenleiter</i> |
| Solder termination <i>Löten</i> | Crimp or solder termination <i>Crimpen oder Löten</i> |

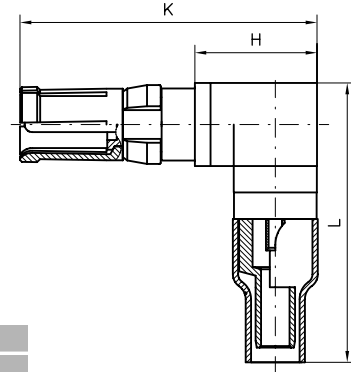

Platings / Oberflächen

| Order Number Plug <i>Bestellnummer Stecker</i> | Type <i>Ausführung</i> | Mating Area <i>Steckbereich</i> | | Termination Area <i>Anschlussbereich</i> | | Suitable Cables RG- <i>Verwendbare Kabel RG-</i> | Order Number Receptacles <i>Bestellnummer Steckdose</i> |
|---|---------------------------|---------------------------------------|---------------------------------------|---|---------------------------------------|---|--|
| | | Inner Conductor <i>Innenleiter</i> | Outer Conductor <i>Außenleiter</i> | Inner Conductor <i>Innenleiter</i> | Outer Conductor <i>Außenleiter</i> | | |
| FMX029P102 | standard | 1,3 µm Au | 0,8 µm Au | 1,3 µm Au | 0,2 µm Au | 174U, | FMX029S102 |
| FMX029P101 | low cost | 0,2 µm Au | 0,2 µm Au | 0,2 µm Au | 5 µm Sn | 188AU, 316U | FMX029S101 |
| FMX029P202 | standard | AuroPur | AuroPur | AuroPur | 0,2 µm Au | 174U, | FMX029S202 |
| FMX029P201 | low cost | AuroPur | AuroPur | AuroPur | 5 µm Sn | 188AU, 316U | FMX029S201 |
| FMX031P102* | standard | 1,3 µm Au | 0,8 µm Au | 1,3 µm Au | 0,2 µm Au | 178BU, | FMX031S102* |
| FMX031P101* | low cost | 0,2 µm Au | 0,2 µm Au | 0,2 µm Au | 5 µm Sn | 196AU, 404U | FMX031S101* |
| FMX032P102* | standard | 1,3 µm Au | 0,8 µm Au | 1,3 µm Au | 0,2 µm Au | 316U double braided | FMX032S102* |
| FMX032P101* | low cost | 0,2 µm Au | 0,2 µm Au | 0,2 µm Au | 5 µm Sn | <i>doppelt geschirmt</i> | FMX032S101* |

Other platings on request / *Andere Oberflächen auf Anfrage*
Tools from page 94 onwards / *Werkzeuge ab Seite 94 ff.*

8 microinches = $\approx 0,2 \mu\text{m}$
30 microinches = $\approx 0,8 \mu\text{m}$

50 microinches = $\approx 1,3 \mu\text{m}$
200 microinches = $\approx 5 \mu\text{m}$

* Turned crimp ferrule with inspection hole, please see illustration on page 31.
* *Gedrehte Crimphülse mit Inspektionsbohrung, siehe Darstellung auf Seite 31.*

Dimensions

Abmessungen

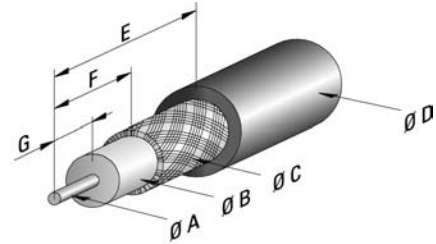
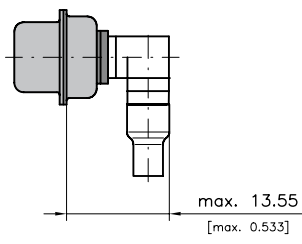

| Order Number <i>Bestellnummer</i> | Ø A max. | Ø B max. | Ø C max. | Ø D max. | E | F | G | H | J | K | L |
|--------------------------------------|-----------------|----------------|----------------|----------------|----------------|----------------|----------------|-----------------|-----------------|-----------------|-----------------|
| FMX029... | 0,85 (0.033) | 1,9 (0.075) | 2,3 (0.091) | 3,2 (0.126) | 9,5 (0.374) | 5,0 (0.197) | 3,0 (0.118) | 8,00 (0.315) | 19,3 (0.760) | 19,8 (0.780) | 18,5 (0.728) |
| FMX031... | 0,85 (0.033) | 1,2 (0.047) | 1,4 (0.055) | 2,3 (0.091) | 9,5 (0.374) | 5,0 (0.197) | 3,0 (0.118) | 8,00 (0.315) | 19,3 (0.760) | 19,8 (0.780) | 18,5 (0.728) |
| FMX032... | 0,85 (0.033) | 1,9 (0.075) | 2,7 (0.106) | 3,2 (0.126) | 9,5 (0.374) | 5,0 (0.197) | 3,0 (0.118) | 8,00 (0.315) | 19,3 (0.760) | 19,8 (0.780) | 19,5 (0.768) |



FMX Coaxial Contacts, 75 Ohm, Straight Cable Termination

FMX Koaxialkontakte, 75 Ohm, gerader Kabelanschluss

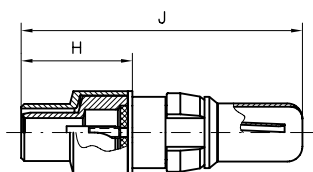

| | |
|---------------------------------------|--|
| Inner Conductor <i>Innenleiter</i> | Outer Conductor <i>Außenleiter</i> |
| Solder termination <i>Löten</i> | Crimp or solder termination <i>Crimpen oder Löten</i> |

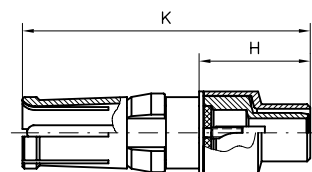

| Order Number Plug <i>Bestellnummer Stecker</i> | Type <i>Ausführung</i> | Platings / <i>Oberflächen</i> | | | | Suitable Cables RG- <i>Verwendbare Kabel RG-</i> | Order Number Receptacles <i>Bestellnummer Steckdose</i> |
|--|---------------------------|---------------------------------------|---------------------------------------|---|---------------------------------------|--|---|
| | | Mating Area <i>Steckbereich</i> | | Termination Area <i>Anschlussbereich</i> | | | |
| | | Inner Conductor <i>Innenleiter</i> | Outer Conductor <i>Außenleiter</i> | Inner Conductor <i>Innenleiter</i> | Outer Conductor <i>Außenleiter</i> | | |
| FMX002P102 * | standard | 1,3 µm Au | 0,8 µm Au | 1,3 µm Au | 0,2 µm Au | 179BU, 187AU | FMX002S102 * |
| FMX002P101 * | low cost | 0,2 µm Au | 0,2 µm Au | 0,2 µm Au | 5 µm Sn | | FMX002S101 * |
| FMX002P202 * | standard | AuroPur | AuroPur | AuroPur | 0,2 µm Au | 179BU, 187AU | FMX002S202 * |
| FMX002P201 * | low cost | AuroPur | AuroPur | AuroPur | 5 µm Sn | | FMX002S201 * |
| FMX003P102 ** | standard | 1,3 µm Au | 0,8 µm Au | 1,3 µm Au | 0,2 µm Au | 179BU, 187AU | FMX003S102 ** |
| FMX003P101 ** | low cost | 0,2 µm Au | 0,2 µm Au | 0,2 µm Au | 5 µm Sn | | FMX003S101 ** |

Other platings on request / *Andere Oberflächen auf Anfrage*

Tools from page 94 onwards / *Werkzeuge ab Seite 94 ff*

8 microinches = $\approx 0,2 \mu\text{m}$

30 microinches = $\approx 0,8 \mu\text{m}$

50 microinches = $\approx 1,3 \mu\text{m}$

200 microinches = $\approx 5 \mu\text{m}$

* Short version / *kurze Version*

** Deep-drawn crimp ferrule without inspection hole, please see illustration on page 32.

** *Tiefgezogene Crimphülse ohne Inspektionsbohrung, siehe Darstellung auf Seite 32.*

Dimensions

Abmessungen

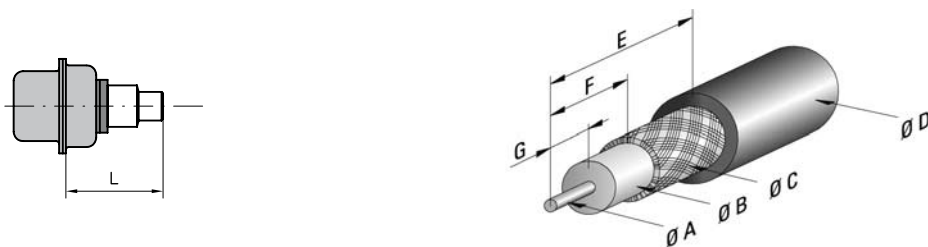

| Order Number <i>Bestellnummer</i> | Ø A max. | Ø B max. | Ø C max. | Ø D max. | E | F | G | H | J | K | L |
|--------------------------------------|----------------|----------------|----------------|----------------|----------------|----------------|----------------|-----------------|------------------|------------------|-----------------|
| FMX002... | 0,5 (0.020) | 1,9 (0.075) | 2,3 (0.091) | 3,2 (0.126) | 6,0 (0.236) | 3,1 (0.122) | 2,0 (0.079) | 7,3 (0.287) | 18,55 (0.730) | 19,05 (0.750) | 12,8 (0.504) |
| FMX003... | 0,5 (0.020) | 1,9 (0.075) | 2,3 (0.091) | 3,2 (0.126) | 9,5 (0.374) | 5,0 (0.197) | 3,0 (0.118) | 11,2 (0.441) | 22,5 (0.886) | 23,0 (0.906) | 16,7 (0.657) |



FMS Coaxial Contacts, 50 Ohm, Straight Cable Termination

FMS Koaxialkontakte, 50 Ohm, gerader Kabelanschluss

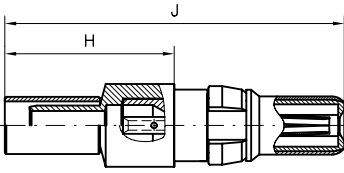

| | |
|---|---------------------------------------|
| Inner Conductor <i>Innenleiter</i> | Outer Conductor <i>Außenleiter</i> |
| Crimp termination <i>Crimpen</i> | Crimp termination <i>Crimpen</i> |
| Crimp snap-in system <i>Crimp Snap-in System</i> | |

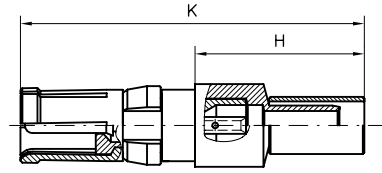

Platings / Oberflächen

| | | Mating Area <i>Steckbereich</i> | | Termination Area <i>Anschlussbereich</i> | | | |
|--|---------------------------|---------------------------------------|---------------------------------------|---|---------------------------------------|---|---|
| Order Number Plug <i>Bestellnummer Stecker</i> | Type <i>Ausführung</i> | Inner Conductor <i>Innenleiter</i> | Outer Conductor <i>Außenleiter</i> | Inner Conductor <i>Innenleiter</i> | Outer Conductor <i>Außenleiter</i> | Suitable Cables RG- <i>Verwendbare Kabel RG-</i> | Order Number Receptacles <i>Bestellnummer Steckdose</i> |
| FMS001P102 | standard | 1,3 µm Au | 0,8 µm Au | 1,3 µm Au | 0,2 µm Au | 174U, | FMS001S102 |
| FMS001P101 | low cost | 0,2 µm Au | 0,2 µm Au | 0,2 µm Au | 5 µm Sn | 188AU, 316U | FMS001S101 |
| FMS001P202 | standard | AuroPur | AuroPur | AuroPur | 0,2 µm Au | 174U, | FMS001S202 |
| FMS001P201 | low cost | AuroPur | AuroPur | AuroPur | 5 µm Sn | 188AU, 316U | FMS001S201 |
| FMS006P102 | standard | 1,3 µm Au | 0,8 µm Au | 1,3 µm Au | 0,2 µm Au | 316U double braided <i>doppelt geschirmt</i> | FMS006S102 |
| FMS006P101 | low cost | 0,2 µm Au | 0,2 µm Au | 0,2 µm Au | 5 µm Sn | | FMS006S101 |
| FMS009P102 | standard | 1,3 µm Au | 0,8 µm Au | 1,3 µm Au | 0,2 µm Au | 58CU, 141AU | FMS009S102 |
| FMS009P101 | low cost | 0,2 µm Au | 0,2 µm Au | 0,2 µm Au | 5 µm Sn | | FMS009S101 |

Other platings on request / *Andere Oberflächen auf Anfrage*
 Tools from page 94 onwards / *Werkzeuge ab Seite 94 ff.*

8 microinches = $\approx 0,2 \mu\text{m}$
 30 microinches = $\approx 0,8 \mu\text{m}$
 50 microinches = $\approx 1,3 \mu\text{m}$
 200 microinches = $\approx 5 \mu\text{m}$

Dimensions

Abmessungen

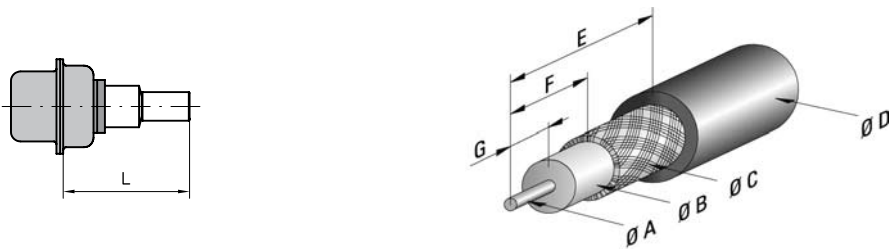

| Order Number <i>Bestellnummer</i> | Ø A max. | Ø B max. | Ø C max. | Ø D max. | E | F | G | H approx. ca. | J approx. ca. | K approx. ca. | L |
|--------------------------------------|----------------|----------------|----------------|----------------|----------------|----------------|----------------|---------------------|---------------------|---------------------|-----------------|
| FMS001... | 0,6 (0.024) | 1,9 (0.075) | 2,4 (0.094) | 3,2 (0.126) | 9,0 (0.354) | 4,3 (0.169) | 3,0 (0.118) | 11,2 (0.441) | 22,45 (0.884) | 22,95 (0.904) | 16,6 (0.654) |
| FMS006... | 0,6 (0.024) | 1,9 (0.075) | 2,7 (0.106) | 3,8 (0.150) | 9,3 (0.366) | 4,3 (0.169) | 3,0 (0.118) | 11,2 (0.441) | 22,45 (0.884) | 22,95 (0.904) | 16,6 (0.654) |
| FMS009... | 1,3 (0.051) | 3,7 (0.146) | 4,5 (0.177) | 5,2 (0.205) | 8,3 (0.327) | 3,6 (0.142) | 2,7 (0.106) | 10,7 (0.421) | 22,15 (0.872) | 22,65 (0.892) | 16,3 (0.642) |



FMS Coaxial Contacts, 50 Ohm, Right Angled Cable Termination

FMS Koaxialkontakte, 50 Ohm, abgewinkelter Kabelanschluss

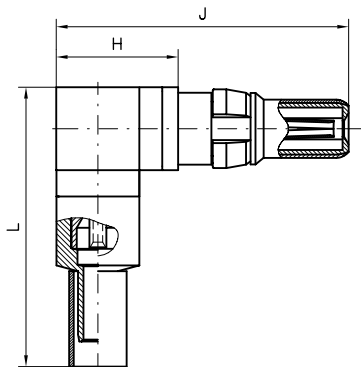

Inner Conductor
Innenleiter
Outer Conductor
Außenleiter
Crimp termination
Crimpen
Crimp termination
Crimpen
Crimp snap-in system
Crimp Snap-in System

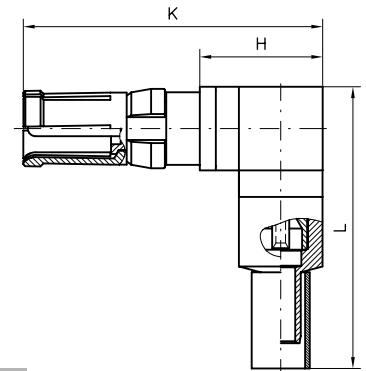

| Order Number Plug <i>Bestellnummer Stecker</i> | Type <i>Ausführung</i> | Platings / <i>Oberflächen</i> | | | | Suitable Cables RG- <i>Verwendbare Kabel RG-</i> | Order Number Receptacles <i>Bestellnummer Steckdose</i> |
|--|---------------------------|---------------------------------------|---------------------------------------|---|---------------------------------------|---|---|
| | | Mating Area <i>Steckbereich</i> | | Termination Area <i>Anschlussbereich</i> | | | |
| | | Inner Conductor <i>Innenleiter</i> | Outer Conductor <i>Außenleiter</i> | Inner Conductor <i>Innenleiter</i> | Outer Conductor <i>Außenleiter</i> | | |
| FMS012P102 | standard | 1,3 μm Au | 0,8 μm Au | 1,3 μm Au | 0,2 μm Au | 174U | FMS012S102 |
| FMS012P101 | low cost | 0,2 μm Au | 0,2 μm Au | 0,2 μm Au | 5 μm Sn | 188AU, 316U | FMS012S101 |
| FMS012P202 | standard | AuroPur | AuroPur | AuroPur | 0,2 μm Au | 174U | FMS012S202 |
| FMS012P201 | low cost | AuroPur | AuroPur | AuroPur | 5 μm Sn | 188AU, 316U | FMS012S201 |
| FMS022P102 | standard | 1,3 μm Au | 0,8 μm Au | 1,3 μm Au | 0,2 μm Au | 316U double braided <i>doppelt geschirmt</i> | FMS022S102 |
| FMS022P101 | low cost | 0,2 μm Au | 0,2 μm Au | 0,2 μm Au | 5 μm Sn | | FMS022S101 |
| FMS026P102 | standard | 1,3 μm Au | 0,8 μm Au | 1,3 μm Au | 0,2 μm Au | 58 C/U | FMS026S102 |
| FMS026P101 | low cost | 0,2 μm Au | 0,2 μm Au | 0,2 μm Au | 5 μm Sn | | FMS026S101 |

Other platings on request / *Andere Oberflächen auf Anfrage*
 Tools from page 94 onwards / *Werkzeuge ab Seite 94 ff.*

8 microinches = $\approx 0,2 \mu\text{m}$
 30 microinches = $\approx 0,8 \mu\text{m}$

50 microinches = $\approx 1,3 \mu\text{m}$
 200 microinches = $\approx 5 \mu\text{m}$

Dimensions

Abmessungen

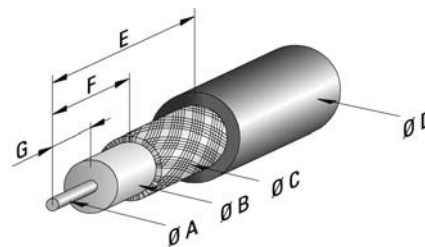
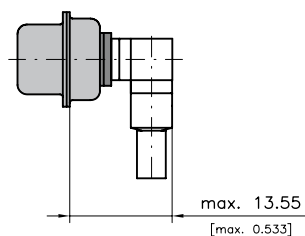

| Order Number <i>Bestellnummer</i> | Ø A max. | Ø B max. | Ø C max. | Ø D max. | E | F | G | H | J | K | L approx. ca. |
|--------------------------------------|----------------|----------------|----------------|----------------|----------------|----------------|----------------|-----------------|------------------|-----------------|---------------------|
| FMS012... | 0,6 (0.024) | 1,9 (0.075) | 2,3 (0.091) | 3,2 (0.126) | 9,0 (0.354) | 3,8 (0.150) | 2,3 (0.091) | 8,0 (0.315) | 19,25 (0.758) | 19,8 (0.780) | 18,5 (0.728) |
| FMS022... | 0,6 (0.024) | 1,9 (0.075) | 3,0 (0.118) | 3,5 (0.138) | 9,0 (0.354) | 3,8 (0.150) | 2,3 (0.091) | 8,05 (0.317) | 19,3 (0.760) | 19,8 (0.780) | 18,5 (0.728) |
| FMS026... | 1,0 (0.039) | 3,7 (0.146) | 4,3 (0.169) | 5,2 (0.205) | 8,3 (0.327) | 3,6 (0.142) | 2,7 (0.106) | 8,05 (0.317) | 19,3 (0.760) | 19,8 (0.780) | 18,5 (0.728) |



FMS Coaxial Contacts, 75 Ohm, Straight Cable Termination

FMS Koaxialkontakte, 75 Ohm, gerader Kabelanschluss

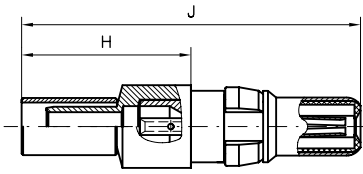

| | |
|---|---------------------------------------|
| Inner Conductor <i>Innenleiter</i> | Outer Conductor <i>Außenleiter</i> |
| Crimp termination <i>Crimpen</i> | Crimp termination <i>Crimpen</i> |
| Crimp snap-in system <i>Crimp Snap-in System</i> | |

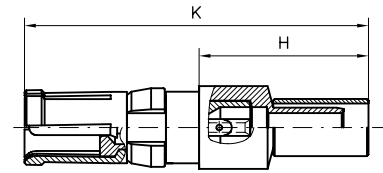

Platings / Oberflächen

| Mating Area <i>Steckbereich</i> | | Termination Area <i>Anschlussbereich</i> | |
|---------------------------------------|---------------------------------------|---|---------------------------------------|
| Inner Conductor <i>Innenleiter</i> | Outer Conductor <i>Außenleiter</i> | Inner Conductor <i>Innenleiter</i> | Outer Conductor <i>Außenleiter</i> |

| Order Number Plug <i>Bestellnummer Stecker</i> | Type <i>Ausführung</i> | Inner Conductor <i>Innenleiter</i> | Outer Conductor <i>Außenleiter</i> | Inner Conductor <i>Innenleiter</i> | Outer Conductor <i>Außenleiter</i> | Suitable Cables RG- <i>Verwendbare Kabel RG-</i> | Order Number Receptacles <i>Bestellnummer Steckdose</i> |
|---|---------------------------|---------------------------------------|---------------------------------------|---------------------------------------|---------------------------------------|---|--|
| FMS002P102 | standard | 1,3 µm Au | 0,8 µm Au | 1,3 µm Au | 0,2 µm Au | 179BU, 187AU | FMS002S102 |
| FMS002P101 | low cost | 0,2 µm Au | 0,2 µm Au | 0,2 µm Au | 5 µm Sn | | FMS002S101 |
| FMS002P202 | standard | AuroPur | AuroPur | AuroPur | 0,2 µm Au | 179BU, 187AU | FMS002S202 |
| FMS002P201 | low cost | AuroPur | AuroPur | AuroPur | 5 µm Sn | | FMS002S201 |
| FMS003P102 | standard | 1,3 µm Au | 0,8 µm Au | 1,3 µm Au | 0,2 µm Au | 180BU | FMS003S102 |
| FMS003P101 | low cost | 0,2 µm Au | 0,2 µm Au | 0,2 µm Au | 5 µm Sn | | FMS003S101 |

Other platings on request / *Andere Oberflächen auf Anfrage*
Tools from page 94 onwards / *Werkzeuge ab Seite 94 ff.*

8 microinches = $\approx 0,2 \mu\text{m}$
30 microinches = $\approx 0,8 \mu\text{m}$

50 microinches = $\approx 1,3 \mu\text{m}$
200 microinches = $\approx 5 \mu\text{m}$

Dimensions

Abmessungen

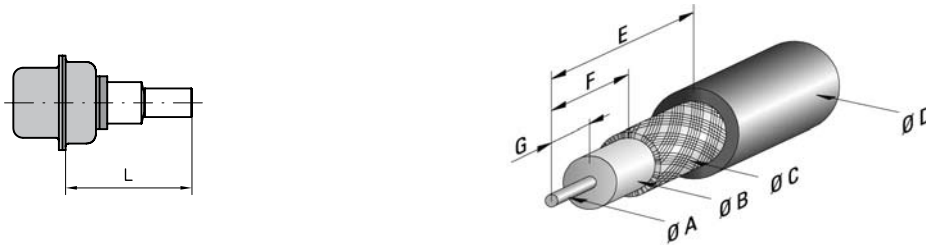

| Order Number <i>Bestellnummer</i> | Ø A max. | Ø B max. | Ø C max. | Ø D max. | E | F | G | H approx. ca. | J approx. ca. | K approx. ca. | L |
|--------------------------------------|----------------|----------------|----------------|----------------|----------------|----------------|----------------|---------------------|---------------------|---------------------|-----------------|
| FMS002... | 0,6 (0.024) | 1,9 (0.075) | 2,4 (0.094) | 3,2 (0.126) | 9,0 (0.354) | 4,3 (0.169) | 3,0 (0.118) | 11,2 (0.441) | 22,45 (0.884) | 22,95 (0.904) | 16,7 (0.657) |
| FMS003... | 0,6 (0.024) | 2,8 (0.110) | 3,3 (0.130) | 4,5 (0.177) | 8,5 (0.335) | 3,5 (0.138) | 3,0 (0.118) | 10,2 (0.402) | 21,65 (0.852) | 22,15 (0.872) | 15,9 (0.626) |



FMS Coaxial Contacts, 75 Ohm, Right Angled Cable Termination

FMS Koaxialkontakte, 75 Ohm, abgewinkelter Kabelanschluss

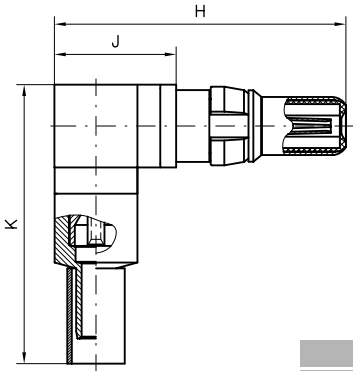

| | |
|--|--|
| Inner Conductor <i>Innenleiter</i> | Outer Conductor <i>Außenleiter</i> |
| Crimp termination <i>Crimpen</i> | Crimp termination <i>Crimpen</i> |
| Crimp snap-in system <i>Crimp Snap-in System</i> | |

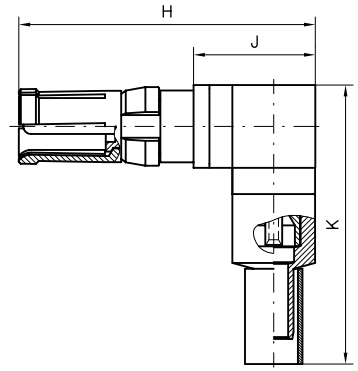

| Platings / Oberflächen | | | | | | Suitable Cables RG- Verwendbare Kabel RG- | Order Number Receptacles Bestellnummer Steckdose |
|--|--------------------|--------------------------------------|--------------------------------|--------------------------------|--------------------------------|--|---|
| Mating Area Steckbereich | | Termination Area Anschlussbereich | | | | | |
| Order Number Plug Bestellnummer Stecker | Type Ausführung | Inner Conductor Innenleiter | Outer Conductor Außenleiter | Inner Conductor Innenleiter | Outer Conductor Außenleiter | | |
| FMS015P102 | standard | 1,3 µm Au | 0,8 µm Au | 1,3 µm Au | 0,2 µm Au | 179BU, 187AU | FMS015S102 |
| FMS015P101 | low cost | 0,2 µm Au | 0,2 µm Au | 0,2 µm Au | 5 µm Sn | | FMS015S101 |
| FMS015P202 | standard | AuroPur | AuroPur | AuroPur | 0,2 µm Au | 179BU, 187AU | FMS015S202 |
| FMS015P201 | low cost | AuroPur | AuroPur | AuroPur | 5 µm Sn | | FMS015S201 |

Other platings on request / *Andere Oberflächen auf Anfrage*
Tools from page 94 onwards / *Werkzeuge ab Seite 94 ff.*

8 microinches = $\approx 0,2 \mu\text{m}$
30 microinches = $\approx 0,8 \mu\text{m}$

50 microinches = $\approx 1,3 \mu\text{m}$
200 microinches = $\approx 5 \mu\text{m}$

Dimensions

Abmessungen

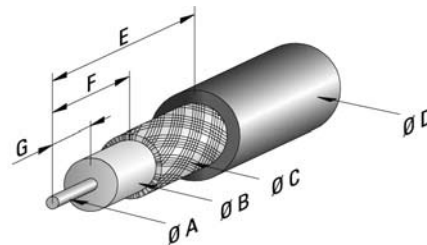
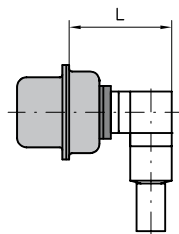

| Order Number Bestellnummer | Ø A max. | Ø B max. | Ø C max. | Ø D max. | E | F | G | H | J | K approx. ca. | L |
|-------------------------------|----------------|----------------|----------------|----------------|----------------|----------------|----------------|------------------|----------------|---------------------|------------------|
| FMS015... | 0,6 (0.024) | 1,9 (0.075) | 2,3 (0.091) | 3,2 (0.126) | 9,0 (0.354) | 3,8 (0.150) | 2,3 (0.091) | 19,25 (0.758) | 8,0 (0.315) | 18,5 (0.728) | 13,55 (0.533) |



Coaxial Contacts, Mating Area Dimensions, Pin Diameter 0.75 mm (0.030")

Koaxialkontakte, Abmessungen Steckbereich, Pindurchmesser 0,75 mm

Plug

Stecker

Socket

Buchse

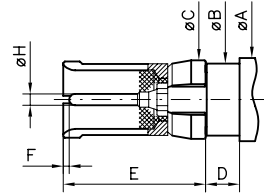
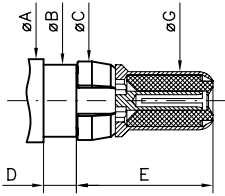

| | Plug / Stecker | | Socket / Buchse | | | |
|-----------|-----------------|-----------------|-----------------|-----------------|-----------------|-----------------|
| | min | max. | min | Modi. U* | | max. |
| ØA | — | 5,50 (0.217) | — | — | | 5,50 (0.217) |
| ØB | 4,75 (0.187) | 4,80 (0.189) | 4,75 (0.187) | — | | 4,80 (0.189) |
| ØC | 5,00 (0.197) | 5,40 (0.213) | 5,00 (0.197) | — | | 5,40 (0.213) |
| D | 2,25 (0.089) | 2,45 (0.096) | 2,25 (0.089) | 2,10 (0.083) | 2,45 (0.096) | 2,25 (0.089) |
| E | — | 9,00 (0.354) | — | — | | 9,5 (0.374) |
| F | — | — | 0,10 (0.004) | — | | 0,50 (0.020) |
| ØG | 3,83 (0.151) | 3,87 (0.152) | — | — | | — |
| ØH | — | — | 0,74 (0.029) | — | | 0,76 (0.030) |

Modification U* please see page 26

Modifikation U* siehe Seite 26



FMS Coaxial Contacts, 50 Ohm, Straight Cable Termination, Pin Diameter 0.75 mm (0.030")

FMS Koaxialkontakte, 50 Ohm, gerader Kabelanschluss, Pindurchmesser 0,75 mm

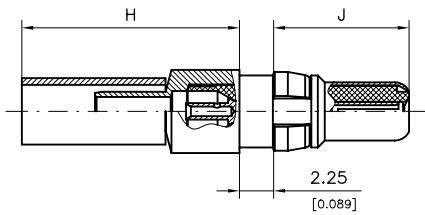

| | |
|---|---------------------------------------|
| Inner Conductor <i>Innenleiter</i> | Outer Conductor <i>Außenleiter</i> |
| Crimp termination <i>Crimpen</i> | Crimp termination <i>Crimpen</i> |
| Crimp snap-in system <i>Crimp Snap-in System</i> | |

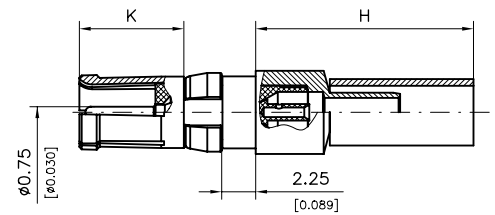

| Order Number Plug <i>Bestellnummer Stecker</i> | Type <i>Ausführung</i> | Platings / <i>Oberflächen</i> | | Platings / <i>Oberflächen</i> | | Suitable Cables RG- <i>Verwendbare Kabel RG-</i> | Order Number Receptacles <i>Bestellnummer Steckdose</i> |
|---|---------------------------|---------------------------------------|---|---------------------------------------|---|---|--|
| | | Mating Area <i>Steckbereich</i> | Termination Area <i>Anschlussbereich</i> | Mating Area <i>Steckbereich</i> | Termination Area <i>Anschlussbereich</i> | | |
| | | Inner Conductor <i>Innenleiter</i> | Outer Conductor <i>Außenleiter</i> | Inner Conductor <i>Innenleiter</i> | Outer Conductor <i>Außenleiter</i> | | |
| FMS016P102 | standard | 1,3 µm Au | 0,8 µm Au | 1,3 µm Au | 0,2 µm Au | 316U double braided <i>doppelt geschirmt</i> | FMS016S102 |
| FMS016P101 | low cost | 0,2 µm Au | 0,2 µm Au | 0,2 µm Au | 5 µm Sn | | FMS016S101 |
| FMS016P202 | standard | AuroPur | AuroPur | AuroPur | 0,2 µm Au | 316U double braided <i>doppelt geschirmt</i> | FMS016S202 |
| FMS016P201 | low cost | AuroPur | AuroPur | AuroPur | 5 µm Sn | | FMS016S201 |

Other platings on request / *Andere Oberflächen auf Anfrage*
Tools from page 94 onwards / *Werkzeuge ab Seite 94 ff.*

8 microinches = $\approx 0,2 \mu\text{m}$
30 microinches = $\approx 0,8 \mu\text{m}$

50 microinches = $\approx 1,3 \mu\text{m}$
200 microinches = $\approx 5 \mu\text{m}$

FMX Coaxial Contacts, 50 Ohm, Straight Cable Termination, Pin Diameter 0.75 mm (0.030")

FMX Koaxialkontakte, 50 Ohm, gerader Kabelanschluss, Pindurchmesser 0,75 mm

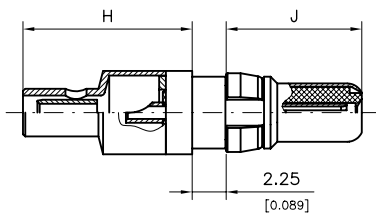

| | |
|---------------------------------------|---------------------------------------|
| Inner Conductor <i>Innenleiter</i> | Outer Conductor <i>Außenleiter</i> |
| — | Crimp termination <i>Crimpen</i> |
| Solder termination <i>Löten</i> | Solder termination <i>Löten</i> |

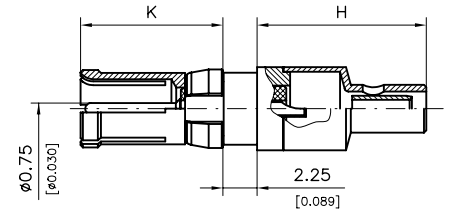

| Order Number Plug <i>Bestellnummer Stecker</i> | Type <i>Ausführung</i> | Platings / <i>Oberflächen</i> | | Platings / <i>Oberflächen</i> | | Suitable Cables RG- <i>Verwendbare Kabel RG-</i> | Order Number Receptacles <i>Bestellnummer Steckdose</i> |
|---|---------------------------|---------------------------------------|---|---------------------------------------|---|---|--|
| | | Mating Area <i>Steckbereich</i> | Termination Area <i>Anschlussbereich</i> | Mating Area <i>Steckbereich</i> | Termination Area <i>Anschlussbereich</i> | | |
| | | Inner Conductor <i>Innenleiter</i> | Outer Conductor <i>Außenleiter</i> | Inner Conductor <i>Innenleiter</i> | Outer Conductor <i>Außenleiter</i> | | |
| FMX058P102 | standard | 1,3 µm Au | 0,8 µm Au | 1,3 µm Au | 0,2 µm Au | 179BU, 196AU, 404U | FMX058S102 |
| FMX058P101 | low cost | 0,2 µm Au | 0,2 µm Au | 0,2 µm Au | 5 µm Sn | | FMX058S101 |
| FMX058P202 | standard | AuroPur | AuroPur | AuroPur | 0,2 µm Au | 179BU, 196AU, 404U | FMX058S202 |
| FMX058P201 | low cost | AuroPur | AuroPur | AuroPur | 5 µm Sn | | FMX058S201 |

Other platings on request / *Andere Oberflächen auf Anfrage*
Tools from page 94 onwards / *Werkzeuge ab Seite 94 ff.*

8 microinches = $\approx 0,2 \mu\text{m}$
30 microinches = $\approx 0,8 \mu\text{m}$

50 microinches = $\approx 1,3 \mu\text{m}$
200 microinches = $\approx 5 \mu\text{m}$

Dimensions

Abmessungen

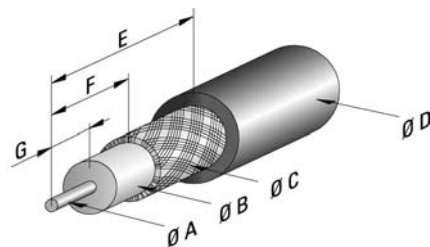
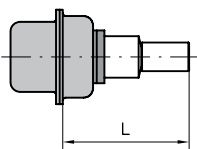

| Order Number <i>Bestellnummer</i> | Ø A max. | Ø B max. | Ø C max. | Ø D max. | E | F | G | H approx. ca. | J | K | L |
|--------------------------------------|-----------------|----------------|----------------|----------------|----------------|----------------|----------------|---------------------|----------------|----------------|-----------------|
| FMS016... | 0,6 (0.024) | 1,9 (0.075) | 2,7 (0.106) | 3,5 (0.138) | 9,3 (0.366) | 4,3 (0.169) | 3,0 (0.118) | 14,4 (0.567) | 9,0 (0.354) | 9,5 (0.374) | 19,9 (0.783) |
| FMX058... | 0,85 (0.033) | 1,2 (0.047) | 1,4 (0.055) | 2,3 (0.091) | 9,5 (0.374) | 5,0 (0.197) | 3,0 (0.118) | 11,2 (0.441) | 9,0 (0.354) | 9,5 (0.374) | 17 (0.669) |

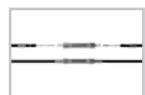

Wiresplice

Wiresplice

50 Ohm

50 Ohm

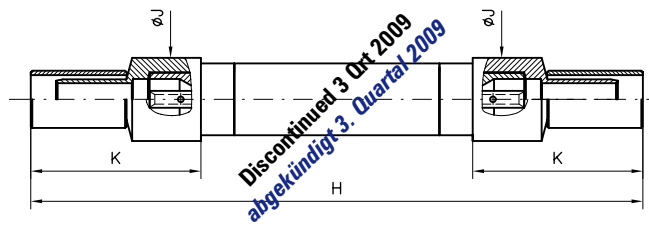

| | |
|--|--|
| Inner Conductor <i>Innenleiter</i> | Outer Conductor <i>Außenleiter</i> |
| Crimp termination <i>Crimpen</i> | Crimp termination <i>Crimpen</i> |

| Order Number <i>Bestellnummer</i> | Type <i>Ausführung</i> | Platings / <i>Oberflächen</i> | | Suitable Cables RG- <i>Verwendbare Kabel RG-</i> |
|--------------------------------------|---------------------------|---------------------------------------|---------------------------------------|---|
| | | Inner Conductor <i>Innenleiter</i> | Outer Conductor <i>Außenleiter</i> | |
| FMS010-102 | standard | 1,3 µm Au | 0,2 µm Au | 174U, 188AU, 316U |
| FMS010-101 | low cost | 0,2 µm Au | 5 µm Sn | |
| FMS030-102 | standard | 1,3 µm Au | 0,2 µm Au | 58CU, 141AU |
| FMS030-101 | low cost | 0,2 µm Au | 5 µm Sn | |

Other platings on request

Andere Oberflächen auf Anfrage

Tools from page 94 onwards

Werkzeuge ab Seite 94 ff.

8 microinches = $\approx 0,2 \mu\text{m}$

30 microinches = $\approx 0,8 \mu\text{m}$

50 microinches = $\approx 1,3 \mu\text{m}$

200 microinches = $\approx 5 \mu\text{m}$

Dimensions

Abmessungen

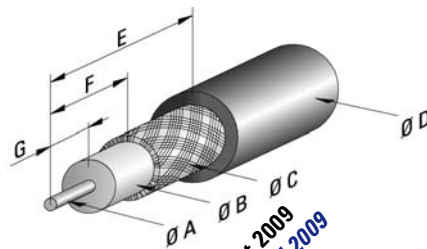

| Order Number <i>Bestellnummer</i> | Ø A max. | Ø B max. | Ø C max. | E max. | F | G | H approx. ca. | J | K approx. ca. | |
|--------------------------------------|----------------|----------------|----------------|----------------|----------------|----------------|---------------------|-----------------|---------------------|------------------|
| FMS010... | 0,6 (0.024) | 1,9 (0.075) | 2,4 (0.094) | 3,2 (0.126) | 9,0 (0.354) | 4,3 (0.169) | 3,0 (0.118) | 40,3 (1.587) | 5,50 (0.217) | 11,30 (0.445) |
| FMS030... | 1,3 (0.051) | 3,7 (0.146) | 4,4 (0.173) | 5,2 (0.205) | 9,0 (0.354) | 4,3 (0.169) | 3,0 (0.118) | 39,7 (1.563) | 5,50 (0.217) | 11,00 (0.433) |



FME Coaxial Contacts, 50 Ohm, Straight PCB Termination, 3 Pins

FME Koaxialkontakte, 50 Ohm, gerader Leiterplattenanschluss, 3 Anschlüsse

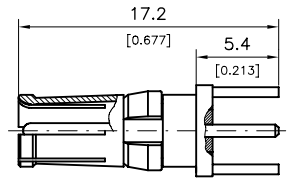
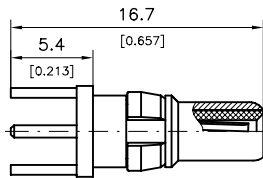

| Order Number Plug <i>Bestellnummer Stecker</i> | Type <i>Ausführung</i> | Platings / <i>Oberflächen</i> | | | | Order Number Receptacles <i>Bestellnummer Steckdose</i> |
|---|---------------------------|---------------------------------------|---------------------------------------|---|---------------------------------------|--|
| | | Mating Area <i>Steckbereich</i> | | Termination Area <i>Anschlussbereich</i> | | |
| | | Inner Conductor <i>Innenleiter</i> | Outer Conductor <i>Außenleiter</i> | Inner Conductor <i>Innenleiter</i> | Outer Conductor <i>Außenleiter</i> | |
| FME010P102 | standard | 1,3 μm Au | 0,8 μm Au | 1,3 μm Au | 0,2 μm Au | FME010S102 |
| FME010P101 | low cost | 0,2 μm Au | 0,2 μm Au | 0,2 μm Au | 5 μm Sn | FME010S101 |
| FME010P108 | | 1,3 μm Au | 0,8 μm Au | 1,3 μm Au | 5 μm Sn | FME010S108 |
| FME010P202 | standard | AuroPur | AuroPur | AuroPur | 0,2 μm Au | FME010S202 |
| FME010P201 | low cost | AuroPur | AuroPur | AuroPur | 5 μm Sn | FME010S201 |

Other platings on request / *Andere Oberflächen auf Anfrage*

8 microinches = $\approx 0,2 \mu\text{m}$
 30 microinches = $\approx 0,8 \mu\text{m}$

50 microinches = $\approx 1,3 \mu\text{m}$
 200 microinches = $\approx 5 \mu\text{m}$

Dimensions of an Example Connector with Coaxial Contact FME010P... and Signal Contacts P1

Abmessungen am Beispiel Steckverbinder mit Koaxialkontakt FME010P... und Signalkontakten P1

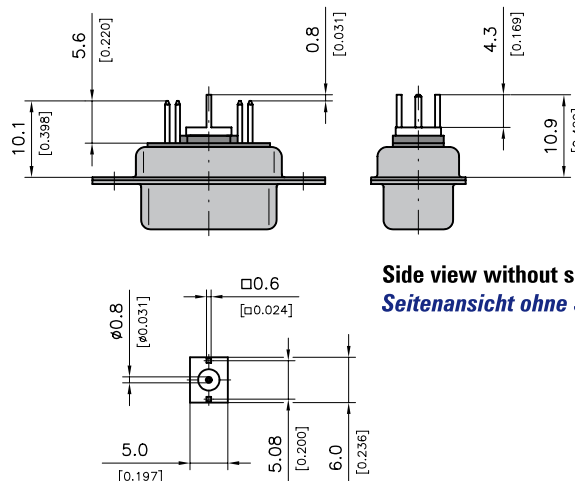

Side view without signal contacts!
Seitenansicht ohne Signalkontakte!



FME Coaxial Contacts, 50 Ohm, Right Angled PCB Termination, 3 Pins

FME Koaxialkontakte, 50 Ohm, abgewinkelter Leiterplattenanschluss, 3 Anschlüsse

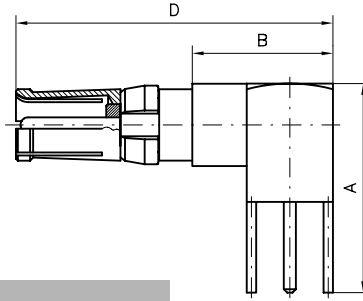
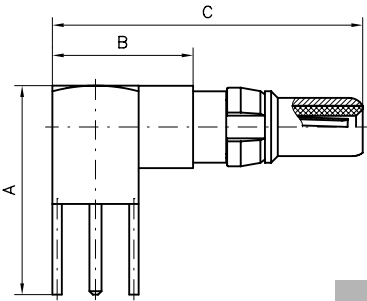

| Order Number Plug <i>Bestellnummer Stecker</i> | Type <i>Ausführung</i> | Platings / <i>Oberflächen</i> | | | | Order Number Receptacles <i>Bestellnummer Steckdose</i> |
|---|---------------------------|---------------------------------------|---------------------------------------|---|---------------------------------------|--|
| | | Mating Area <i>Steckbereich</i> | | Termination Area <i>Anschlussbereich</i> | | |
| | | Inner Conductor <i>Innenleiter</i> | Outer Conductor <i>Außenleiter</i> | Inner Conductor <i>Innenleiter</i> | Outer Conductor <i>Außenleiter</i> | |
| FME008P102 | standard | 1,3 μm Au | 0,8 μm Au | 1,3 μm Au | 0,2 μm Au | FME008S102 |
| FME008P101 | low cost | 0,2 μm Au | 0,2 μm Au | 0,2 μm Au | 5 μm Sn | FME008S101 |
| FME008P108 | | 1,3 μm Au | 0,8 μm Au | 1,3 μm Au | 5 μm Sn | FME008S108 |
| FME008P202 | standard | AuroPur | AuroPur | AuroPur | 0,2 μm Au | FME008S202 |
| FME008P201 | low cost | AuroPur | AuroPur | AuroPur | 5 μm Sn | FME008S201 |
| FME020P102 | standard | 1,3 μm Au | 0,8 μm Au | 1,3 μm Au | 0,2 μm Au | FME020S102 |
| FME020P101 | low cost | 0,2 μm Au | 0,2 μm Au | 0,2 μm Au | 5 μm Sn | FME020S101 |
| FME020P108 | | 1,3 μm Au | 0,8 μm Au | 1,3 μm Au | 5 μm Sn | FME020S108 |

Other platings on request / *Andere Oberflächen auf Anfrage*

8 microinches = $\approx 0,2 \mu\text{m}$

30 microinches = $\approx 0,8 \mu\text{m}$

50 microinches = $\approx 1,3 \mu\text{m}$

200 microinches = $\approx 5 \mu\text{m}$

Type FME020... For use with D-Sub shell size 5 only.

Typ FME020... Nur zur Verwendung in D-Sub Gehäusegröße 5.

Dimensions of an Example Connector with Coaxial Contacts FME008P.. or FME020P.. and Signal Contacts P5

Abmessungen am Beispiel Steckverbinder mit Koaxialkontakten FME008P.. oder FME020P.. und Signalkontakten P5

| Order Number <i>Bestellnummer</i> | A | B | C | D |
|--------------------------------------|-----------------|-----------------|-----------------|-----------------|
| FME008... | 13,8 (0.543) | 9,3 (0.366) | 20,7 (0.815) | 21,2 (0.835) |
| FME020... | 16,8 (0.661) | 11,8 (0.465) | 23,2 (0.913) | 23,7 (0.933) |

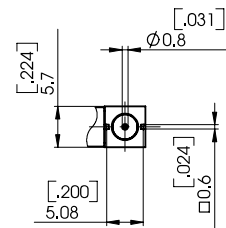

Shell sizes 1 - 4
Gehäusegrößen 1 - 4

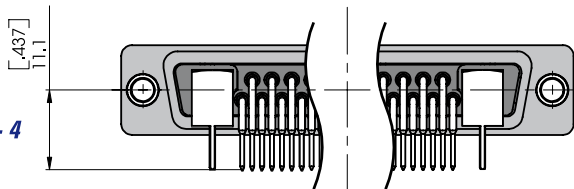

Connector with coaxial contacts FME008P.. and signal contacts P5
Steckverbinder mit Koaxialkontakten FME008P.. und Signalkontakten P5

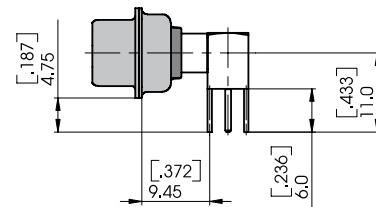

Shell size 5
Gehäusegröße 5

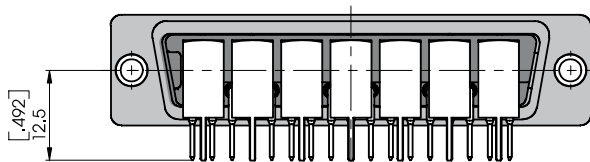

Connector with coaxial contacts FME020P.. and signal contacts P5
Steckverbinder mit Koaxialkontakten FME020P.. und Signalkontakten P5

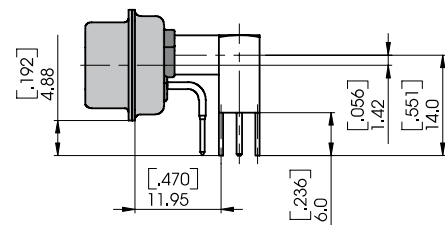



FME Coaxial Contacts, 50 Ohm, Right Angled PCB Termination, 5 Pins

FME Koaxialkontakte, 50 Ohm, abgewinkelter Leiterplattenanschluss, 5 Anschlüsse

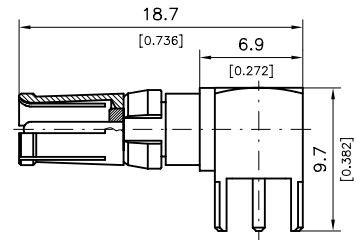
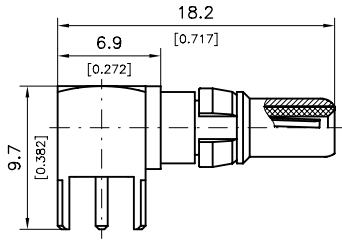

| Order Number Plug <i>Bestellnummer Stecker</i> | Type <i>Ausführung</i> | Platings / <i>Oberflächen</i> | | | | Order Number Receptacles <i>Bestellnummer Steckdose</i> |
|---|---------------------------|---------------------------------------|---------------------------------------|---|---------------------------------------|--|
| | | Mating Area <i>Steckbereich</i> | | Termination Area <i>Anschlussbereich</i> | | |
| | | Inner Conductor <i>Innenleiter</i> | Outer Conductor <i>Außenleiter</i> | Inner Conductor <i>Innenleiter</i> | Outer Conductor <i>Außenleiter</i> | |
| FME009P102 | standard | 1,3 μm Au | 0,8 μm Au | 1,3 μm Au | 0,2 μm Au | FME009S102 |
| FME009P101 | low cost | 0,2 μm Au | 0,2 μm Au | 0,2 μm Au | 5 μm Sn | FME009S101 |
| FME009P108 | | 1,3 μm Au | 0,8 μm Au | 1,3 μm Au | 5 μm Sn | FME009S108 |
| FME009P202 | standard | AuroPur | AuroPur | AuroPur | 0,2 μm Au | FME009S202 |
| FME009P201 | low cost | AuroPur | AuroPur | AuroPur | 5 μm Sn | FME009S201 |

Other platings on request / *Anderer Oberflächen auf Anfrage*

8 microinches = $\approx 0,2 \mu\text{m}$
30 microinches = $\approx 0,8 \mu\text{m}$

50 microinches = $\approx 1,3 \mu\text{m}$
200 microinches = $\approx 5 \mu\text{m}$

Dimensions of an Example Connector with Coaxial Contact FME009P... and Signal Contacts P45

Abmessungen am Beispiel Steckverbinder mit Koaxialkontakt FME009P... und Signalkontakten P45

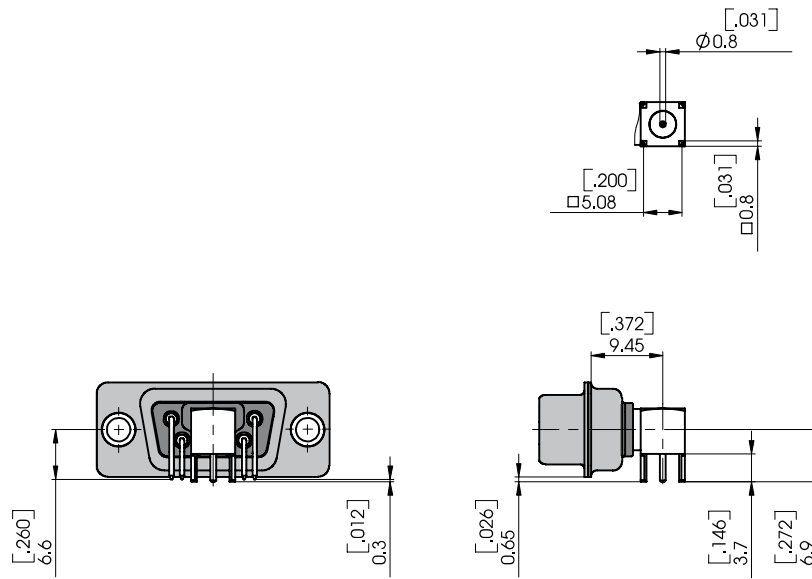

Side view without signal contacts!
Seitenansicht ohne Signalkontakte!



FME Coaxial Contacts, 75 Ohm, Straight PCB Termination, 3 Pins

FME Koaxialkontakte, 75 Ohm, gerader Leiterplattenanschluss, 3 Anschlüsse

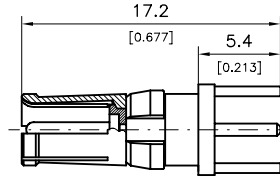
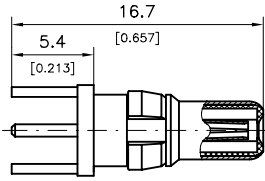

| Order Number Plug <i>Bestellnummer Stecker</i> | Type <i>Ausführung</i> | Platings / <i>Oberflächen</i> | | | | Order Number Receptacles <i>Bestellnummer Steckdose</i> |
|---|---------------------------|---------------------------------------|---------------------------------------|---|---------------------------------------|--|
| | | Mating Area <i>Steckbereich</i> | | Termination Area <i>Anschlussbereich</i> | | |
| | | Inner Conductor <i>Innenleiter</i> | Outer Conductor <i>Außenleiter</i> | Inner Conductor <i>Innenleiter</i> | Outer Conductor <i>Außenleiter</i> | |
| FME005P102 | standard | 1,3 μm Au | 0,8 μm Au | 1,3 μm Au | 0,2 μm Au | FME005S102 |
| FME005P101 | low cost | 0,2 μm Au | 0,2 μm Au | 0,2 μm Au | 5 μm Sn | FME005S101 |
| FME005P108 | | 1,3 μm Au | 0,8 μm Au | 1,3 μm Au | 5 μm Sn | FME005S108 |
| FME005P202 | standard | AuroPur | AuroPur | AuroPur | 0,2 μm Au | FME005S202 |
| FME005P201 | low cost | AuroPur | AuroPur | AuroPur | 5 μm Sn | FME005S201 |

Other platings on request / *Andere Oberflächen auf Anfrage*

8 microinches = $\approx 0,2 \mu\text{m}$
30 microinches = $\approx 0,8 \mu\text{m}$

50 microinches = $\approx 1,3 \mu\text{m}$
200 microinches = $\approx 5 \mu\text{m}$

Dimensions of an Example Connector with Coaxial Contacts FME005P.. and Signal Contacts P1

Abmessungen am Beispiel Steckverbinder mit Koaxialkontakt FME005P.. und Signalkontakten P1

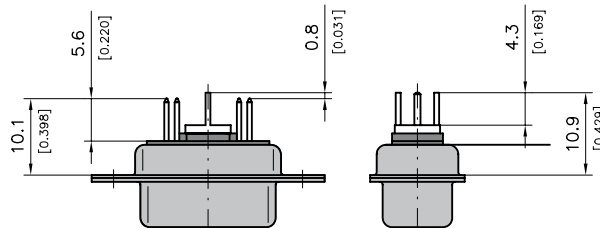

Side view without signal contacts!
Seitenansicht ohne Signalkontakte!

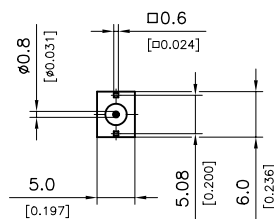



FME Coaxial Contacts, 75 Ohm, Right Angled PCB Termination, 3 Pins

FME Koaxialkontakte, 75 Ohm, abgewinkelter Leiterplattenanschluss, 3 Anschlüsse

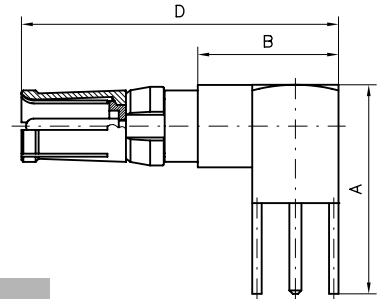
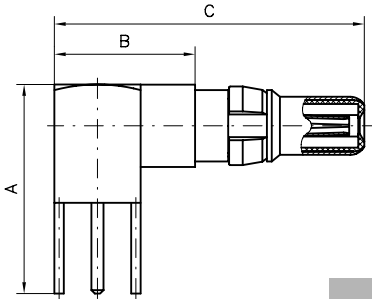

| Order Number Plug <i>Bestellnummer Stecker</i> | Type <i>Ausführung</i> | Platings / <i>Oberflächen</i> | | | | Order Number Receptacles <i>Bestellnummer Steckdose</i> |
|---|---------------------------|---------------------------------------|---------------------------------------|---|---------------------------------------|--|
| | | Mating Area <i>Steckbereich</i> | | Termination Area <i>Anschlussbereich</i> | | |
| | | Inner Conductor <i>Innenleiter</i> | Outer Conductor <i>Außenleiter</i> | Inner Conductor <i>Innenleiter</i> | Outer Conductor <i>Außenleiter</i> | |
| FME001P102 | standard | 1,3 μm Au | 0,8 μm Au | 1,3 μm Au | 0,2 μm Au | FME001S102 |
| FME001P101 | low cost | 0,2 μm Au | 0,2 μm Au | 0,2 μm Au | 5 μm Sn | FME001S101 |
| FME001P108 | | 1,3 μm Au | 0,8 μm Au | 1,3 μm Au | 5 μm Sn | FME001S108 |
| FME001P202 | standard | AuroPur | AuroPur | AuroPur | 0,2 μm Au | FME001S202 |
| FME001P201 | low cost | AuroPur | AuroPur | AuroPur | 5 μm Sn | FME001S201 |
| FME018P102 | standard | 1,3 μm Au | 0,8 μm Au | 1,3 μm Au | 0,2 μm Au | FME018S102 |
| FME018P101 | low cost | 0,2 μm Au | 0,2 μm Au | 0,2 μm Au | 5 μm Sn | FME018S101 |
| FME018P108 | | 1,3 μm Au | 0,8 μm Au | 1,3 μm Au | 5 μm Sn | FME018S108 |

Other platings on request / *Andere Oberflächen auf Anfrage*

8 microinches = $\approx 0,2 \mu\text{m}$

30 microinches = $\approx 0,8 \mu\text{m}$

50 microinches = $\approx 1,3 \mu\text{m}$

200 microinches = $\approx 5 \mu\text{m}$

Type FME018... for use with D-Sub shell size 5 only.

Typ FME018... nur zur Verwendung in D-Sub Gehäusegröße 5.

Dimensions of an Example Connector with Coaxial Contacts FME001P... (Shell Sizes 1 - 4) or FME018P... and Signal Contacts P5

Abmessungen am Beispiel Steckverbinder mit Koaxialkontakten FME001P... (Gehäusegröße 1 - 4) oder FME018P... und Signalkontakten P5

| Order Number <i>Bestellnummer</i> | A | B | C | D |
|--------------------------------------|-----------------|-----------------|-----------------|-----------------|
| FME001... | 13,8 (0.543) | 9,3 (0.366) | 20,7 (0.815) | 21,2 (0.835) |
| FME018... | 16,8 (0.661) | 11,8 (0.465) | 23,2 (0.913) | 23,7 (0.933) |

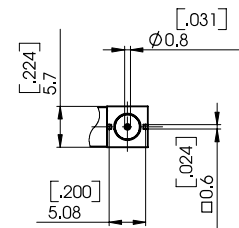

Shell sizes 1 - 4
Gehäusegrößen 1 - 4

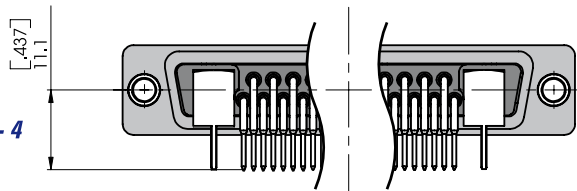

Connector with coaxial contacts FME001P... and signal contacts P5
Steckverbinder mit Koaxialkontakten FME001P... und Signalkontakten P5

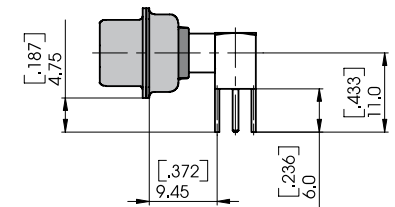

Shell size 5
Gehäusegröße 5

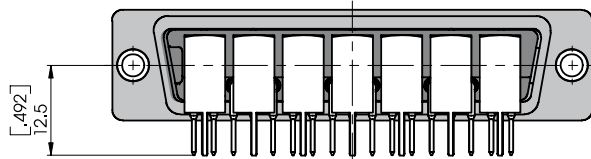

Connector with coaxial contacts FME018P... and signal contacts P5
Steckverbinder mit Koaxialkontakten FME018P... und Signalkontakten P5

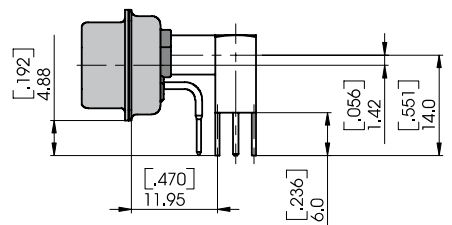



FME Coaxial Contacts, 75 Ohm, Right Angled PCB Termination, 5 Pins

FME Koaxialkontakte, 75 Ohm, abgewinkelter Leiterplattenanschluss, 5 Anschlüsse

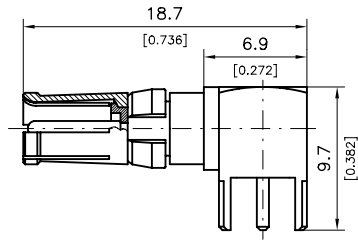
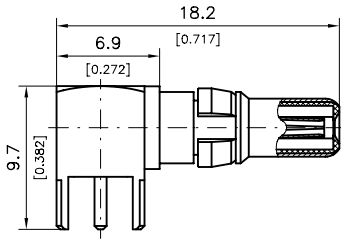

Platings / Oberflächen

| Order Number Plug <i>Bestellnummer Stecker</i> | Type <i>Ausführung</i> | Mating Area <i>Steckbereich</i> | | Termination Area <i>Anschlussbereich</i> | | Order Number Receptacles <i>Bestellnummer Steckdose</i> |
|---|---------------------------|---------------------------------------|---------------------------------------|---|---------------------------------------|--|
| | | Inner Conductor <i>Innenleiter</i> | Outer Conductor <i>Außenleiter</i> | Inner Conductor <i>Innenleiter</i> | Outer Conductor <i>Außenleiter</i> | |
| FME002P102 | standard | 1,3 μm Au | 0,8 μm Au | 1,3 μm Au | 0,2 μm Au | FME002S102 |
| FME002P101 | low cost | 0,2 μm Au | 0,2 μm Au | 0,2 μm Au | 5 μm Sn | FME002S101 |
| FME002P108 | | 1,3 μm Au | 0,8 μm Au | 1,3 μm Au | 5 μm Sn | FME002S108 |
| FME002P202 | standard | AuroPur | AuroPur | AuroPur | 0,2 μm Au | FME002S202 |
| FME002P201 | low cost | AuroPur | AuroPur | AuroPur | 5 μm Sn | FME002S201 |

Other platings on request / *Andere Oberflächen auf Anfrage*

8 microinches = $\approx 0,2 \mu\text{m}$
 30 microinches = $\approx 0,8 \mu\text{m}$

50 microinches = $\approx 1,3 \mu\text{m}$
 200 microinches = $\approx 5 \mu\text{m}$

Dimensions of an Example Connector with Coaxial Contact FME002P... and Signal Contacts P45

Abmessungen am Beispiel Steckverbinder mit Koaxialkontakt FME002P... und Signalkontakten P45

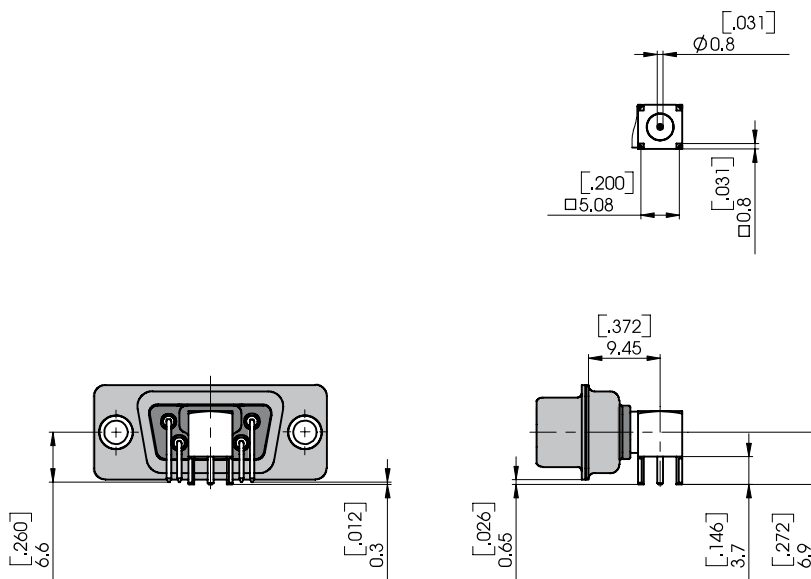

Side view without signal contacts!
Seitenansicht ohne Signalkontakte!

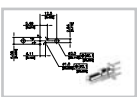

PCB Hole Pattern for Connectors with Straight PCB Terminations

Leiterplattenlochbild für Steckverbinder mit geradem Leiterplattenanschluss

All PCB hole patterns apply to male connectors with straight PCB contacts (signal contacts P1) and the coaxial contacts **FME010P...** or **FME005P...** (when using female connectors the hole pattern must be mirrored on the Y-axis).

Measurements without tolerances are in accordance with DIN ISO 2768 m.

Alle Lochbilder gelten für Stiftsteckverbinder mit geradem Leiterplattenanschluss (Signalkontakte P1) und eingebauten Koaxialkontakten **FME010P...** bzw. **FME005P...** (bei Verwendung von Buchsensteckverbindern muss das Lochbild an der Y-Achse gespiegelt werden).

Maße ohne Toleranzangabe nach DIN ISO 2768 m.

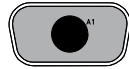

F1W1

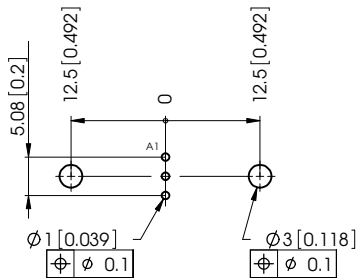

F2W2...C / FM2W2

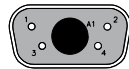
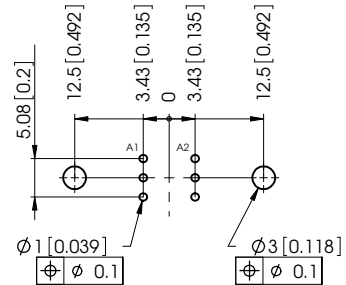

FM5W1

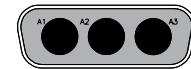
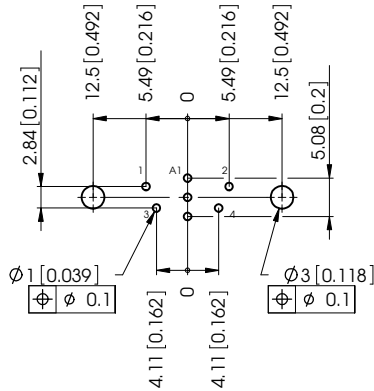

FM3W3 / F3W3...C

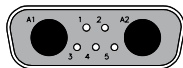
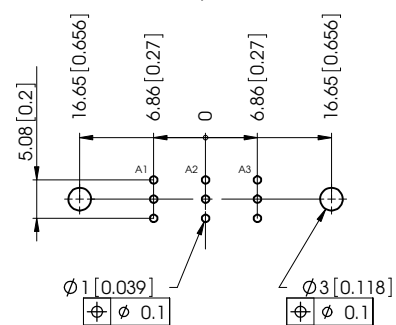

FM7W2

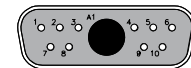
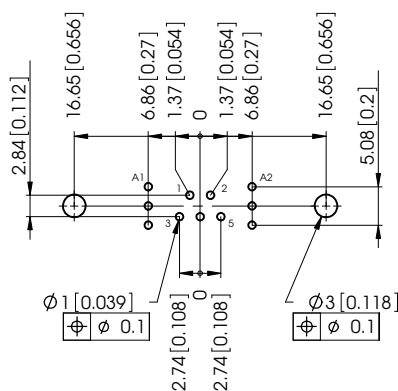

FM11W1

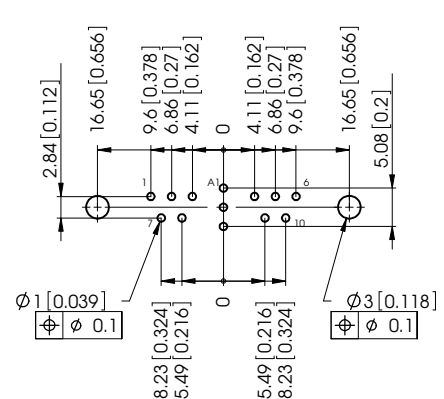

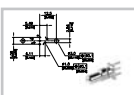

PCB Hole Pattern for Connectors with Straight PCB Terminations

Leiterplattenlochbild für Steckverbinder mit geradem Leiterplattenanschluss

All PCB hole patterns apply to male connectors with straight PCB contacts (signal contacts P1) and the coaxial contacts **FME010P...** or **FME005P...** (when using female connectors the hole pattern must be mirrored on the Y-axis).

Measurements without tolerances are in accordance with DIN ISO 2768 m.

Alle Lochbilder gelten für Stiftsteckverbinder mit geradem Leiterplattenanschluss (Signalkontakte P1) und eingebauten Koaxialkontakten **FME010P...** bzw. **FME005P...** (bei Verwendung von Buchsensteckverbindern muss das Lochbild an der Y-Achse gespiegelt werden).

Maße ohne Toleranzangabe nach DIN ISO 2768 m.

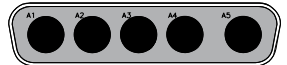

FM5W5

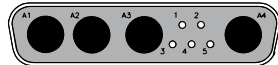
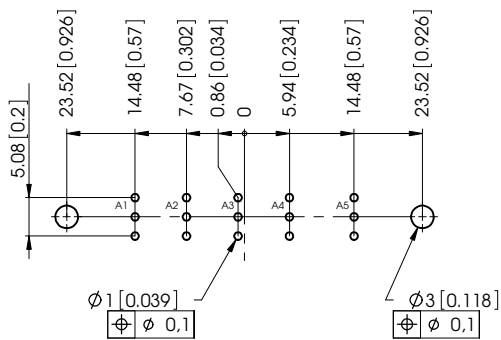

FM9W4

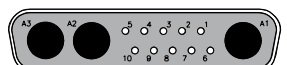
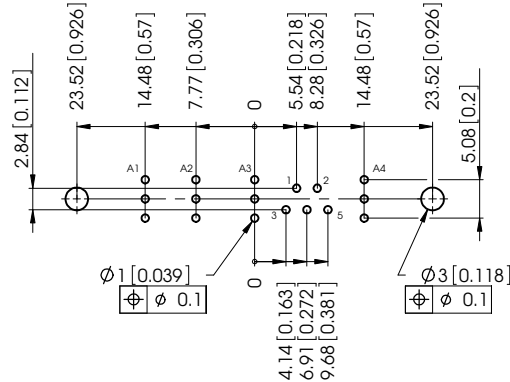

FM13W3

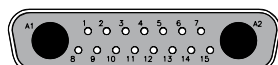
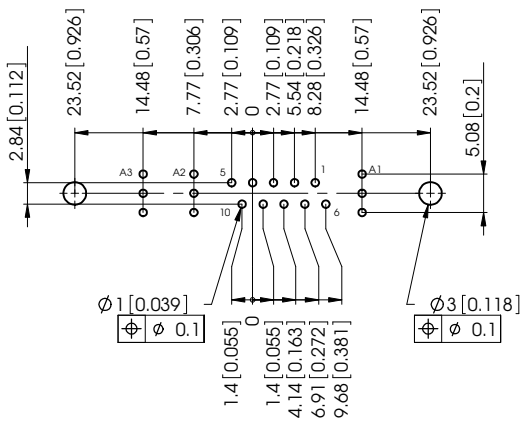

FM17W2

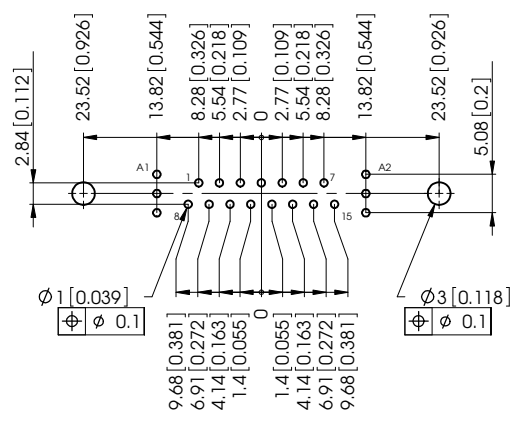

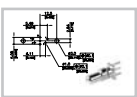

PCB Hole Pattern for Connectors with Straight PCB Terminations

Leiterplattenlochbild für Steckverbinder mit geradem Leiterplattenanschluss

All PCB hole patterns apply to male connectors with straight PCB contacts (signal contacts P1) and the coaxial contacts **FME010P...** or **FME005P...** (when using female connectors the hole pattern must be mirrored on the Y-axis).

Measurements without tolerances are in accordance with DIN ISO 2768 m.

Alle Lochbilder gelten für Stiftsteckverbinder mit geradem Leiterplattenanschluss (Signalkontakte P1) und eingebauten Koaxialkontakten **FME010P...** bzw. **FME005P...** (bei Verwendung von Buchsensteckverbindern muss das Lochbild an der Y-Achse gespiegelt werden).

Maße ohne Toleranzangabe nach DIN ISO 2768 m.

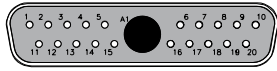

FM21W1

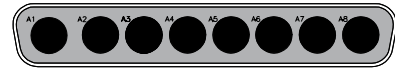
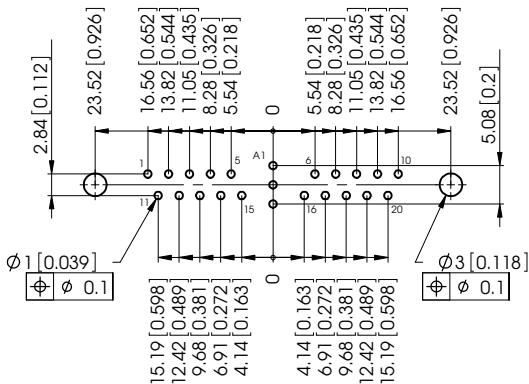

FM8W8

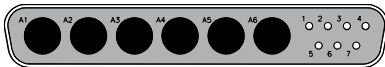
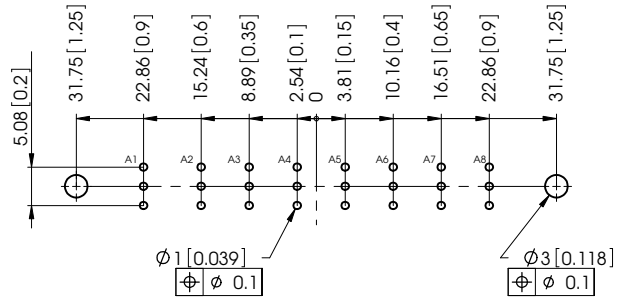

FM13W6

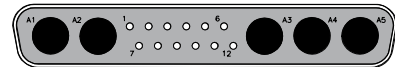
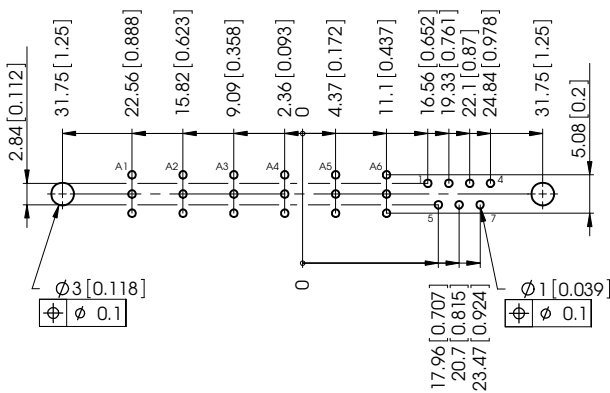

FM17W5

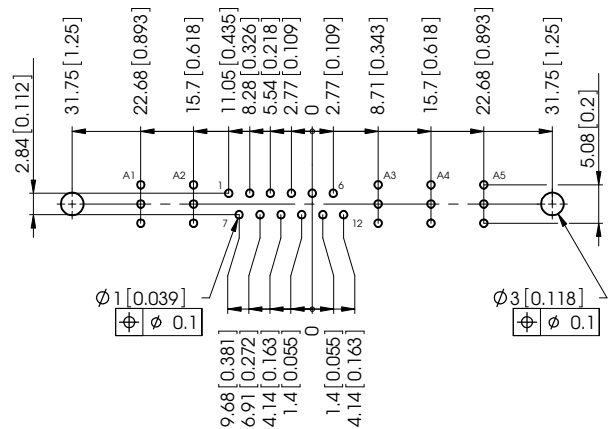

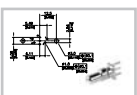

PCB Hole Pattern for Connectors with Straight PCB Terminations

Leiterplattenlochbild für Steckverbinder mit geradem Leiterplattenanschluss

All PCB hole patterns apply to male connectors with straight PCB contacts (signal contacts P1) and the coaxial contacts **FME010P...** or **FME005P...** (when using female connectors the hole pattern must be mirrored on the Y-axis).

Measurements without tolerances are in accordance with DIN ISO 2768 m.

Alle Lochbilder gelten für Stiftsteckverbinder mit geradem Leiterplattenanschluss (Signalkontakte P1) und eingebauten Koaxialkontakten **FME010P...** bzw. **FME005P...** (bei Verwendung von Buchsensteckverbindern muss das Lochbild an der Y-Achse gespiegelt werden).

Maße ohne Toleranzangabe nach DIN ISO 2768 m.

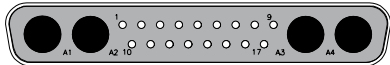

FM21WA4

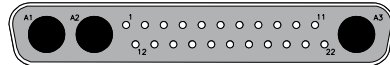
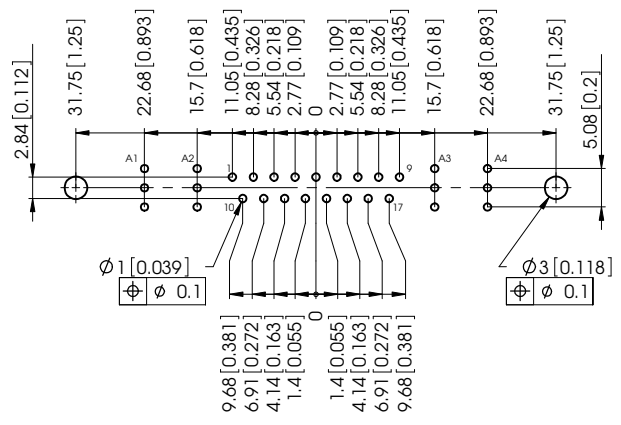

FM25W3

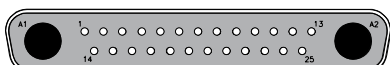
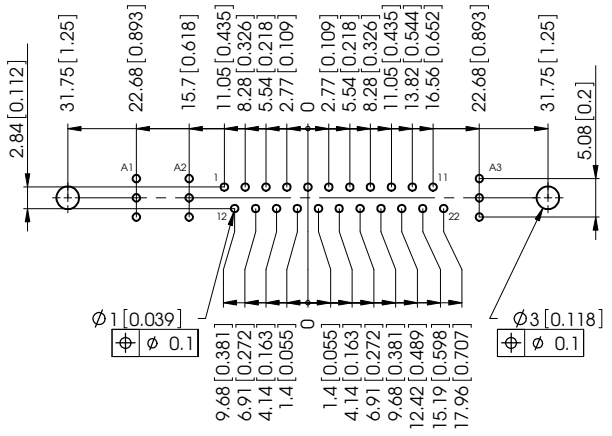

FM27W2

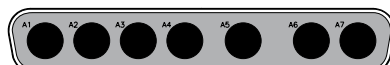
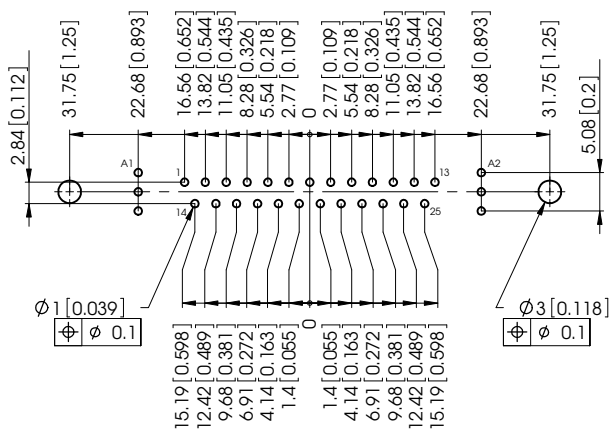

F7W7

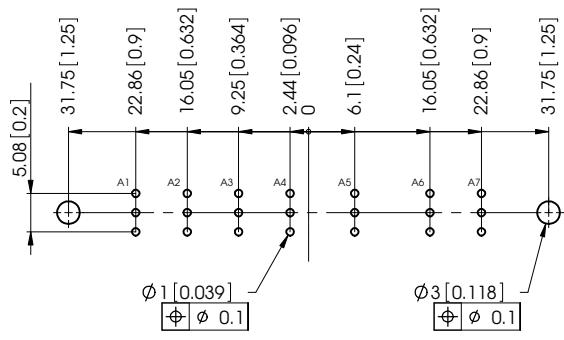

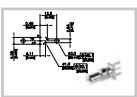

PCB Hole Pattern for Connectors with Straight PCB Terminations

Leiterplattenlochbild für Steckverbinder mit geradem Leiterplattenanschluss

All PCB hole patterns apply to male connectors with straight PCB contacts (signal contacts P1) and the coaxial contacts **FME010P...** or **FME005P...** (when using female connectors the hole pattern must be mirrored on the Y-axis).

Measurements without tolerances are in accordance with DIN ISO 2768 m.

Alle Lochbilder gelten für Stiftsteckverbinder mit geradem Leiterplattenanschluss (Signalkontakte P1) und eingebauten Koaxialkontakten **FME010P...** bzw. **FME005P...** (bei Verwendung von Buchsensteckverbindern muss das Lochbild an der Y-Achse gespiegelt werden).

Maße ohne Toleranzangabe nach DIN ISO 2768 m.

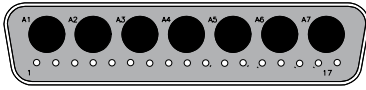

FM24W7

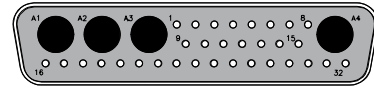
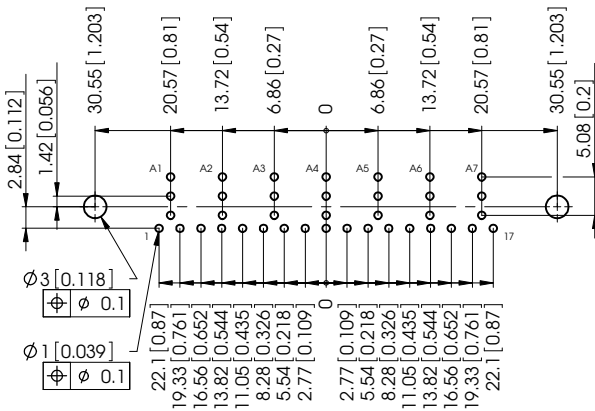

FM36W4

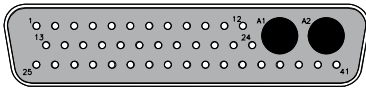
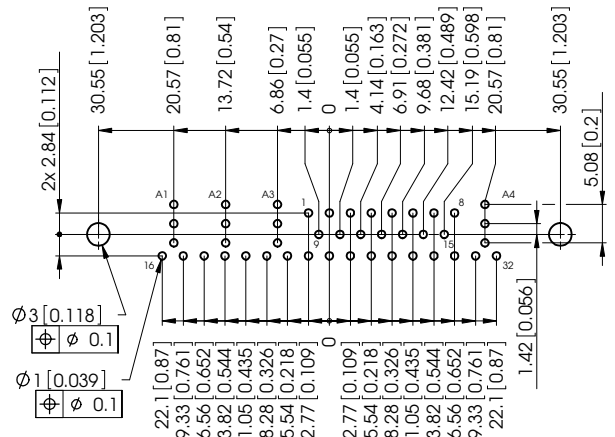

FM43W2

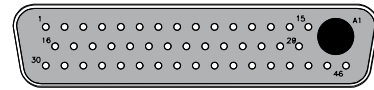
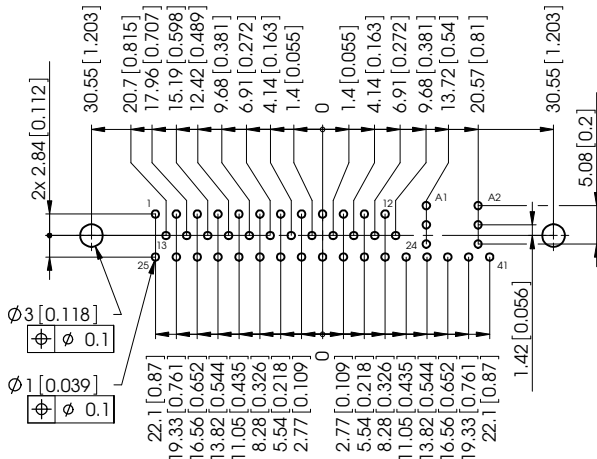

FM47W1

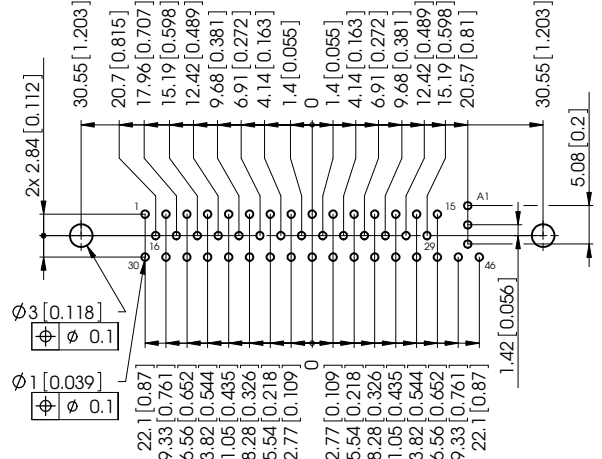

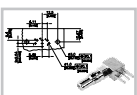

PCB Hole Pattern for Connectors with Right Angled PCB Terminations

Leiterplattenlochbild für Steckverbinder mit abgewinkelttem Leiterplattenanschluss

All PCB hole patterns apply to male connectors with right angle PCB contacts (signal contacts P5) and the metal bracket F1080-13B as well as the coaxial contacts **FME008P...** or **FME001P...** (When using female connectors the hole pattern must be mirrored on the Y-axis).

Measurements without tolerances are in accordance with DIN ISO 2768 m.

Alle Lochbilder gelten für Stiftsteckverbinder mit abgewinkelttem Leiterplattenanschluss (Signalkontakte P5) und Metallwinkel F1080-13B sowie eingebauten Koaxialkontakten **FME008P...** bzw. **FME001P...** (bei Verwendung von Buchsensteckverbindern muss das Lochbild an der Y-Achse gespiegelt werden).

Maße ohne Toleranzangabe nach DIN ISO 2768 m.

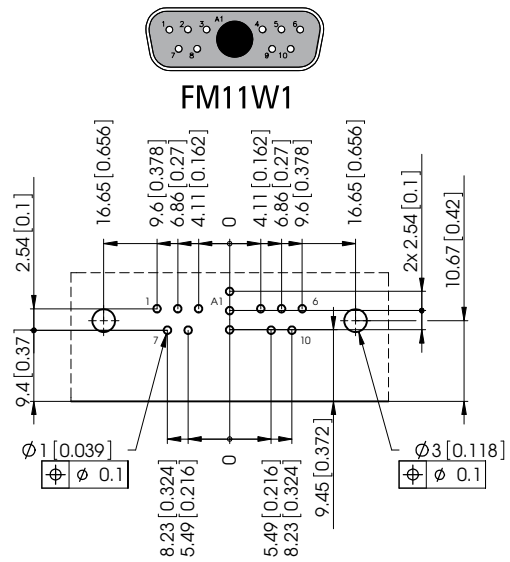
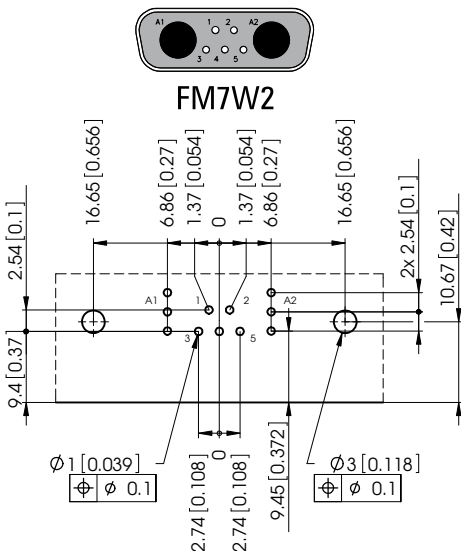
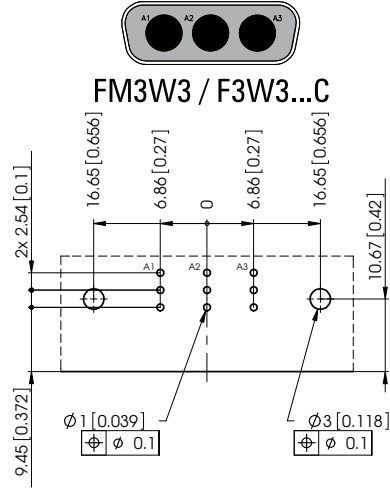
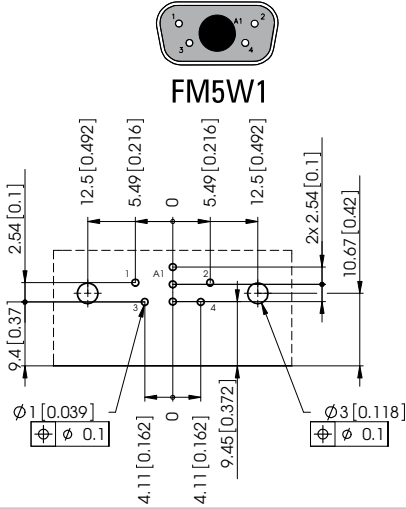
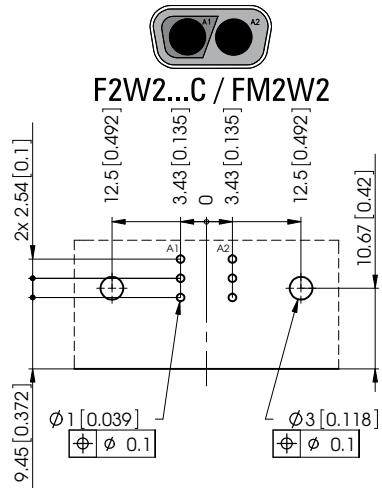
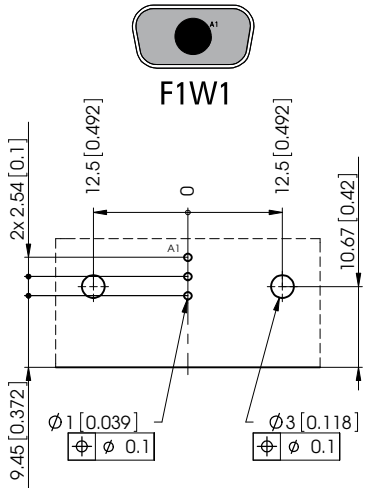

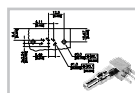

PCB Hole Pattern for Connectors with Right Angled PCB Terminations

Leiterplattenlochbild für Steckverbinder mit abgewinkeltm Leiterplattenanschluss

All PCB hole patterns apply to male connectors with right angle PCB contacts (signal contacts P5) and the metal bracket F1080-13B as well as the coaxial contacts **FME008P..** or **FME001P..** (When using female connectors the hole pattern must be mirrored on the Y-axis). 

Measurements without tolerances are in accordance with DIN ISO 2768 m.

Alle Lochbilder gelten für Stiftsteckverbinder mit abgewinkeltm Leiterplattenanschluss (Signalkontakte P5) und Metallwinkel F1080-13B sowie eingebauten Koaxialkontakten **FME008P..** bzw. **FME001P..** (bei Verwendung von Buchsensteckverbindern muss das Lochbild an der Y-Achse gespiegelt werden).

Maße ohne Toleranzangabe nach DIN ISO 2768 m.

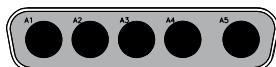

FM5W5

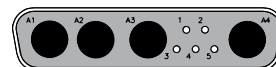
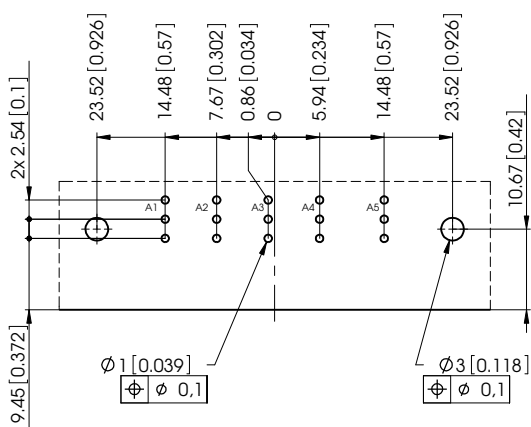

FM9W4

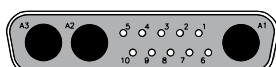
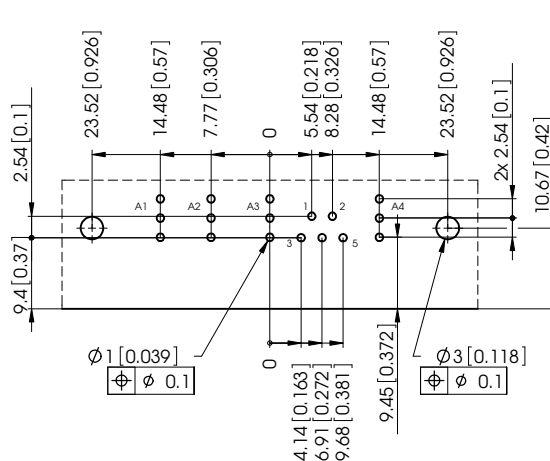

FM13W3

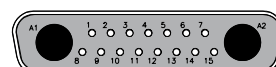
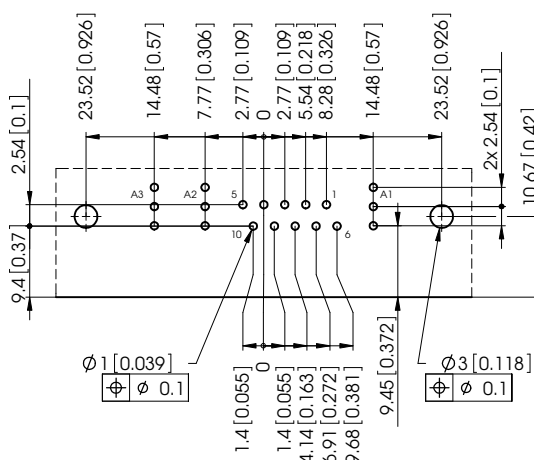

FM17W2

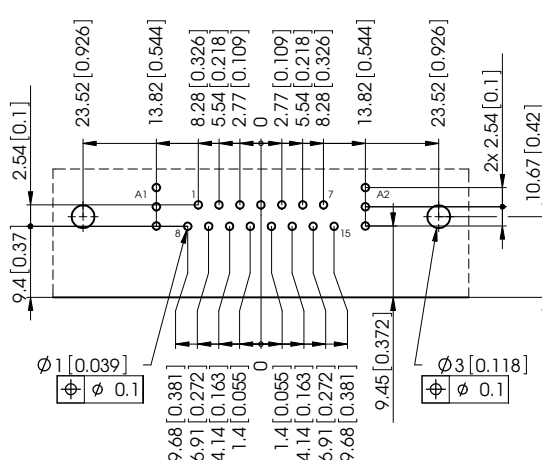

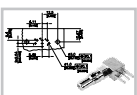

PCB Hole Pattern for Connectors with Right Angled PCB Terminations

Leiterplattenlochbild für Steckverbinder mit abgewinkeltm Leiterplattenanschluss

All PCB hole patterns apply to male connectors with right angle PCB contacts (signal contacts P5) and the metal bracket F1080-13B as well as the coaxial contacts **FME008P...** or **FME001P...** (When using female connectors the hole pattern must be mirrored on the Y-axis).

Measurements without tolerances are in accordance with DIN ISO 2768 m.

Alle Lochbilder gelten für Stiftsteckverbinder mit abgewinkeltm Leiterplattenanschluss (Signalkontakte P5) und Metallwinkel F1080-13B sowie eingebauten Koaxialkontakten **FME008P...** bzw. **FME001P...** (bei Verwendung von Buchsensteckverbindern muss das Lochbild an der Y-Achse gespiegelt werden).

Maße ohne Toleranzangabe nach DIN ISO 2768 m.

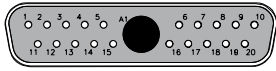

FM21W1

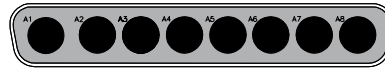
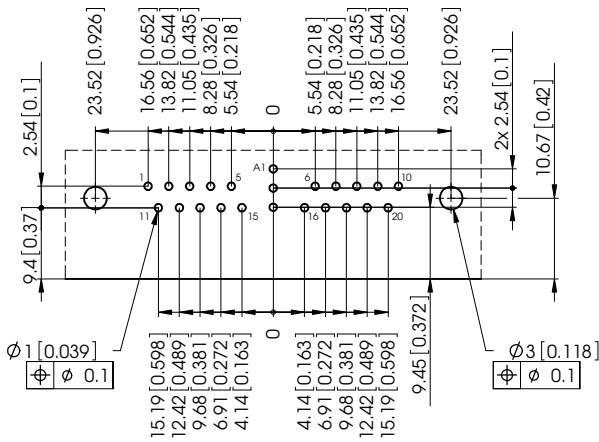

FM8W8

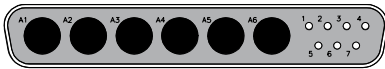
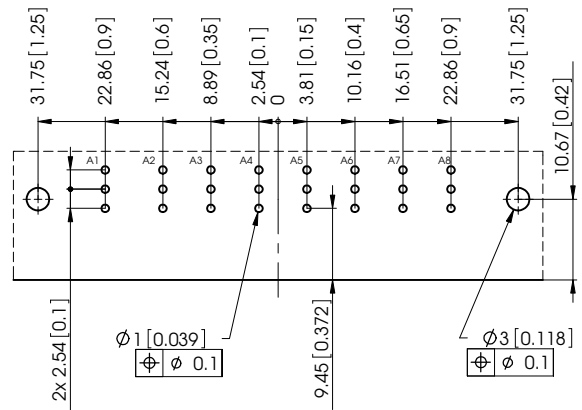

FM13W6

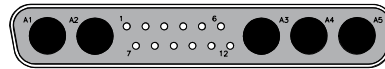
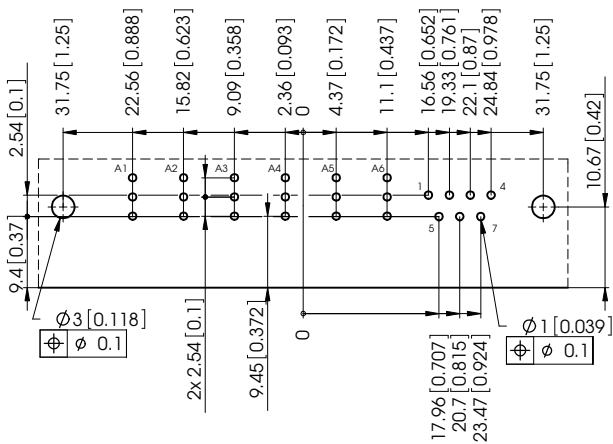

FM17W5

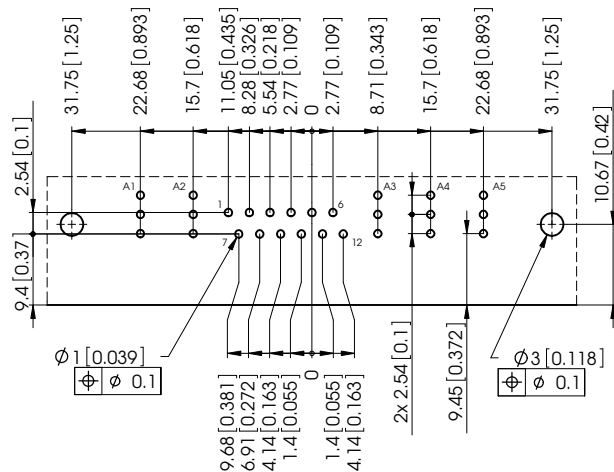

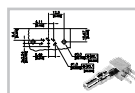

PCB Hole Pattern for Connectors with Right Angled PCB Terminations

Leiterplattenlochbild für Steckverbinder mit abgewinkelttem Leiterplattenanschluss

All PCB hole patterns apply to male connectors with right angle PCB contacts (signal contacts P5) and the metal bracket F1080-13B as well as the coaxial contacts **FME008P..** or **FME001P..** (When using female connectors the hole pattern must be mirrored on the Y-axis). 

Measurements without tolerances are in accordance with DIN ISO 2768 m.

Alle Lochbilder gelten für Stiftsteckverbinder mit abgewinkelttem Leiterplattenanschluss (Signalkontakte P5) und Metallwinkel F1080-13B sowie eingebauten Koaxialkontakten **FME008P..** bzw. **FME001P..** (bei Verwendung von Buchsensteckverbindern muss das Lochbild an der Y-Achse gespiegelt werden).

Maße ohne Toleranzangabe nach DIN ISO 2768 m.

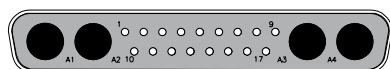

FM21WA4

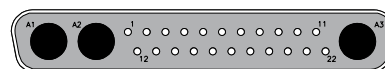
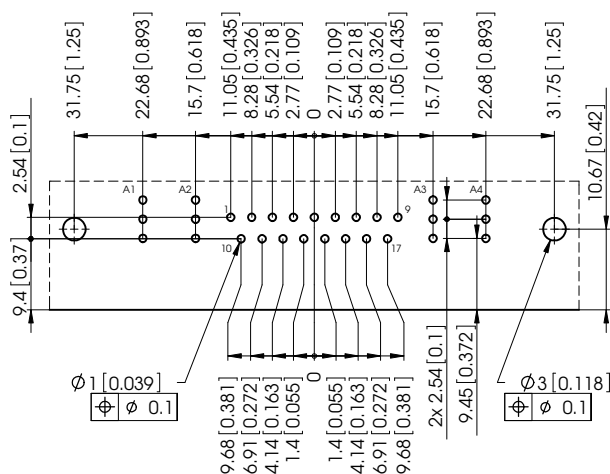

FM25W3

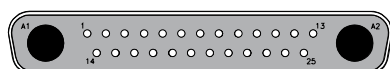
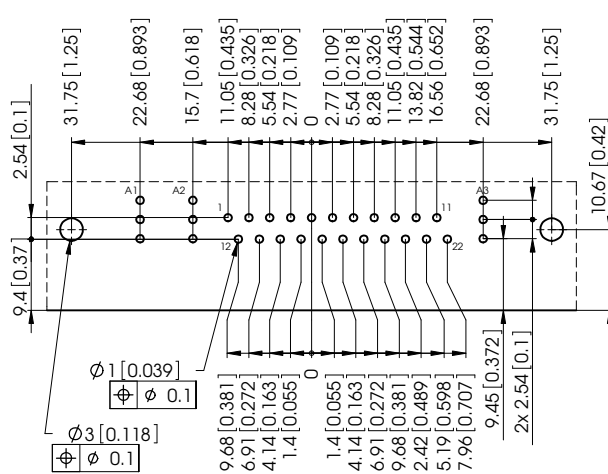

FM27W2

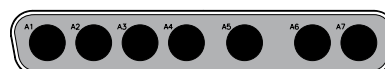
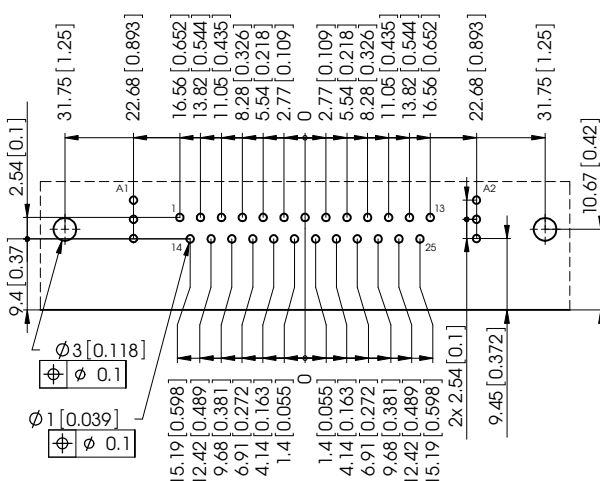

F7W7

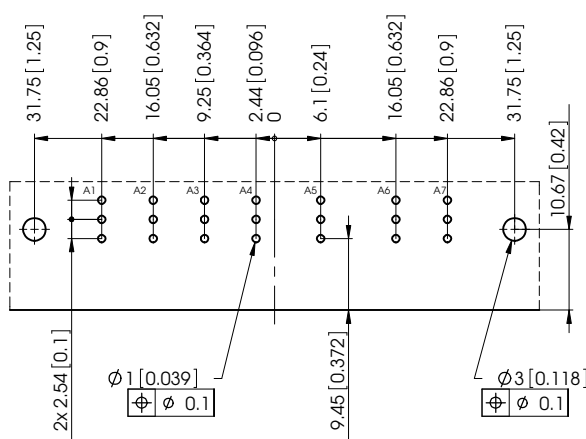

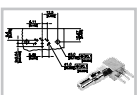

PCB Hole Pattern for Connectors with Right Angled PCB Terminations

Leiterplattenlochbild für Steckverbinder mit abgewinkeltm Leiterplattenanschluss

All PCB hole patterns apply to male connectors with right angle PCB contacts (signal contacts P5) and the metal bracket F1080-23 as well as the coaxial contacts FME018P... or FME020P... (When using female connectors the hole pattern must be mirrored on the Y-axis).

Measurements without tolerances are in accordance with DIN ISO 2768 m. *Alle Lochbilder gelten für Stiftsteckverbinder mit abgewinkeltm Leiterplattenanschluss (Signalkontakte P5) und Metallwinkel F1080-23 sowie eingebauten Koaxialkontakten FME018P... bzw. FME020P... (bei Verwendung von Buchsensteckverbindern muss das Lochbild an der Y-Achse gespiegelt werden).*

Maße ohne Toleranzangabe nach DIN ISO 2768 m.

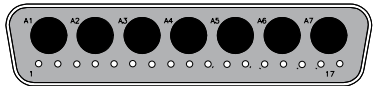

FM24W7

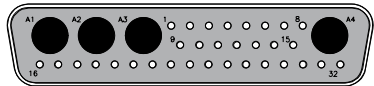

FM36W4

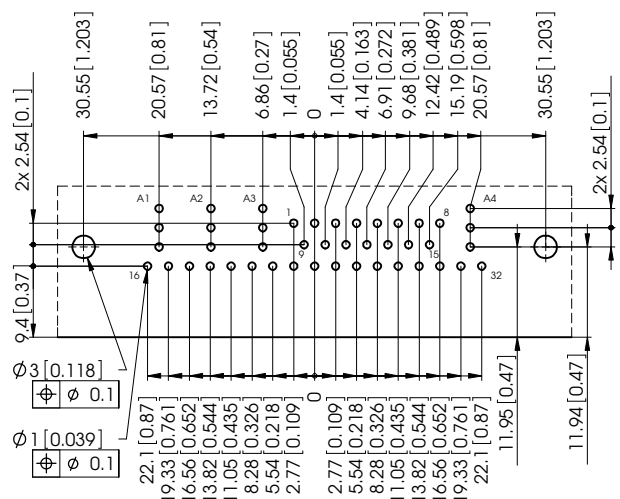
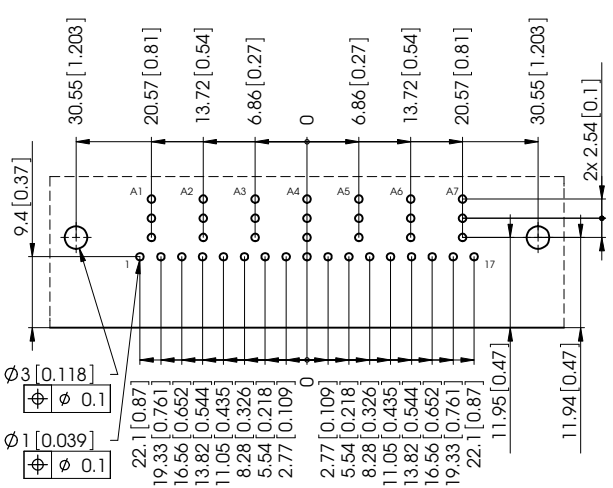

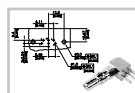

PCB Hole Pattern for Connectors with Right Angled PCB Terminations

Leiterplattenlochbild für Steckverbinder mit abgewinkelttem Leiterplattenanschluss

All PCB hole patterns apply to male connectors with right angle PCB contacts (signal contacts P5) and the metal bracket F1080-23 as well as the coaxial contacts **FME018P...** or **FME020P...** (When using female connectors the hole pattern must be mirrored on the Y-axis). 

Measurements without tolerances are in accordance with DIN ISO 2768 m.
*Alle Lochbilder gelten für Stiftsteckverbinder mit abgewinkelttem Leiterplattenanschluss (Signalkontakte P5) und Metallwinkel F1080-23 sowie eingebauten Koaxialkontakten **FME018P...** bzw. **FME020P...** (bei Verwendung von Buchsensteckverbindern muss das Lochbild an der Y-Achse gespiegelt werden).* 

Maße ohne Toleranzangabe nach DIN ISO 2768 m.

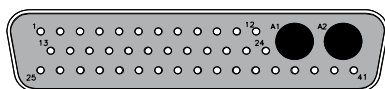

FM43W2

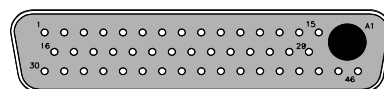
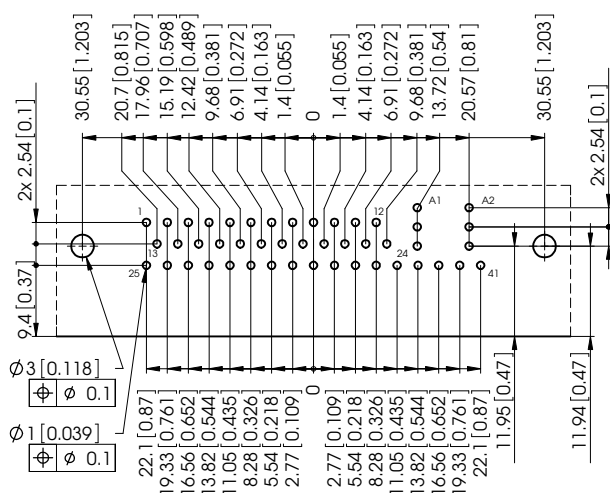

FM47W1

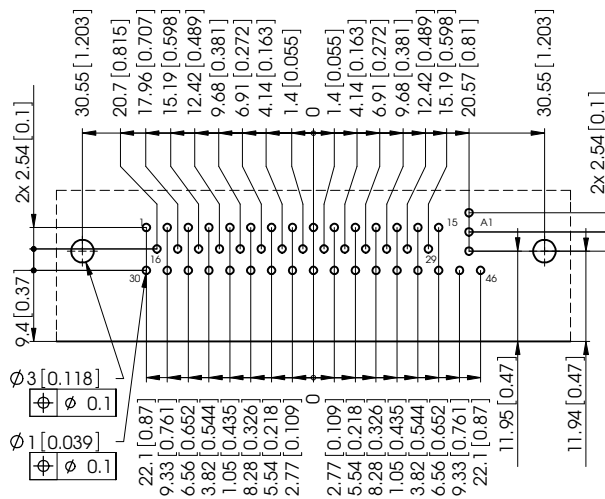



FBM Coaxial Contacts, Mating Area Dimensions

FBM Koaxialkontakte, Abmessungen Steckbereich

Plug

Stecker

Socket

Buchse

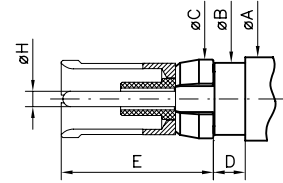
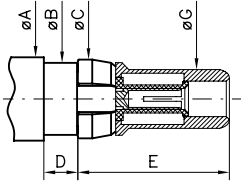

| | Plug / <i>Stecker</i> | | Socket / <i>Buchse</i> | |
|-----------|-----------------------|------------------|------------------------|------------------|
| | min | max. | min Modi. U* | max. Modi. U* |
| ØA | — | 5,60 (0.220) | — | 5,60 (0.220) |
| ØB | 4,75 (0.187) | 4,80 (0.189) | 4,75 (0.187) | 4,80 (0.189) |
| ØC | 5,00 (0.197) | 5,40 (0.213) | 5,00 (0.197) | 5,40 (0.213) |
| D | 2,25 (0.089) | 2,45 (0.096) | 2,10 (0.083) | 2,25 (0.089) |
| E | — | 10,00 (0.394) | — | 10,10 (0.398) |
| ØF | — | 2,35 (0.093) | — | — |
| ØG | 3,88 (0.153) | 3,92 (0.154) | — | — |
| ØH | — | — | 1,00 (0.039) | 1,04 (0.041) |

Modification U* please see page 26

Modifikation U siehe Seite 26*



Hole patterns for FBM coaxial contacts please refer to pages 47 onwards.
Lochbilder für FBM Koaxialkontakte siehe ab Seite 47 ff.



FBM Coaxial Contacts, 50 Ohm, Straight Cable Termination

FBM Koaxialkontakte, 50 Ohm, gerader Kabelanschluss

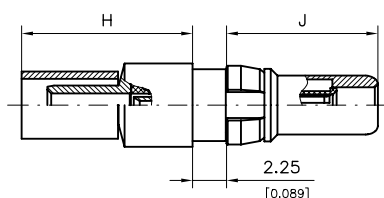

| | |
|---------------------------------------|---------------------------------------|
| Inner Conductor <i>Innenleiter</i> | Outer Conductor <i>Außenleiter</i> |
| — | Crimp termination <i>Crimpen</i> |
| Solder termination <i>Löten</i> | Solder termination <i>Löten</i> |

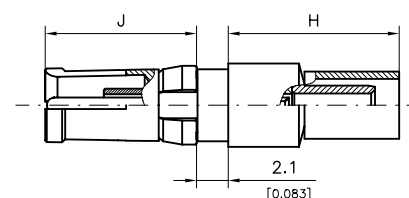

| Order Number Plug <i>Bestellnummer Stecker</i> | Type <i>Ausführung</i> | Platings / <i>Oberflächen</i> | | | | Suitable Cables RG- <i>Verwendbare Kabel RG-</i> | Order Number Receptacles <i>Bestellnummer Steckdose</i> |
|---|---------------------------|---------------------------------------|---------------------------------------|---|---------------------------------------|---|--|
| | | Mating Area <i>Steckbereich</i> | | Termination Area <i>Anschlussbereich</i> | | | |
| | | Inner Conductor <i>Innenleiter</i> | Outer Conductor <i>Außenleiter</i> | Inner Conductor <i>Innenleiter</i> | Outer Conductor <i>Außenleiter</i> | | |
| FBM002P154M | CuBe | 1,3 μm Au | 0,8 μm Au | 1,3 μm Au | 0,2 μm Au | 316, double braided <i>doppelt geschirmt</i> | FBM002S154U |
| FBM003P154M | CuBe | 1,3 μm Au | 1,3 μm Au | 1,3 μm Au | 0,2 μm Au | 316 | FBM003S154U |

Other platings on request / *Andere Oberflächen auf Anfrage*

Tools from page 94 onwards / *Werkzeuge ab Seite 94 ff.*

8 microinches = $\approx 0,2 \mu\text{m}$

30 microinches = $\approx 0,8 \mu\text{m}$

50 microinches = $\approx 1,3 \mu\text{m}$

200 microinches = $\approx 5 \mu\text{m}$

Dimensions

Abmessungen

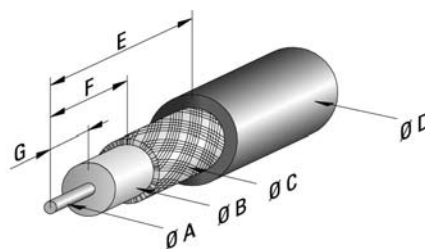
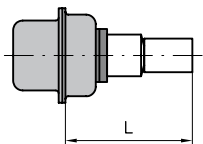

| Order Number <i>Bestellnummer</i> | Ø A max. | Ø B max. | Ø C max. | Ø D max. | E | F | G | H | J | L |
|--------------------------------------|-----------------|-----------------|----------------|----------------|----------------|----------------|----------------|-----------------|-----------------|-----------------|
| FBM002P... | 0,55 (0.022) | 1,55 (0.061) | 2,5 (0.098) | 3,5 (0.138) | 9,5 (0.374) | 5,0 (0.197) | 3,0 (0.118) | 11,3 (0.445) | 10,0 (0.394) | 16,7 (0.657) |
| FBM002S... | 0,55 (0.022) | 1,55 (0.061) | 2,5 (0.098) | 3,5 (0.138) | 9,5 (0.374) | 5,0 (0.197) | 3,0 (0.118) | 11,5 (0.453) | 10,1 (0.398) | 16,9 (0.665) |
| FBM003P... | 0,55 (0.022) | 1,55 (0.061) | 2,2 (0.087) | 3,2 (0.126) | 9,5 (0.374) | 5,0 (0.197) | 3,0 (0.118) | 11,3 (0.445) | 10,0 (0.394) | 16,7 (0.657) |
| FBM003S... | 0,55 (0.022) | 1,55 (0.061) | 2,2 (0.087) | 3,2 (0.126) | 9,5 (0.374) | 5,0 (0.197) | 3,0 (0.118) | 11,5 (0.453) | 10,1 (0.398) | 16,9 (0.665) |



FBM Coaxial Contacts, 50 Ohm, Straight Semi Rigid Cable Termination

FBM Koaxialkontakte, 50 Ohm, gerader semi rigid Kabelanschluss

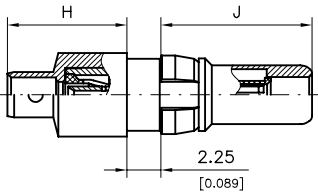

| | |
|--|--|
| Inner Conductor <i>Innenleiter</i> | Outer Conductor <i>Außenleiter</i> |
| Crimp termination <i>Crimpen</i> | — |
| Solder termination <i>Löten</i> | Solder termination <i>Löten</i> |

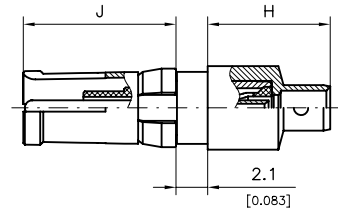

| Order Number Plug <i>Bestellnummer Stecker</i> | Type <i>Ausführung</i> | Platings / <i>Oberflächen</i> | | | | Suitable Cables <i>Verwendbare Kabel</i> | Order Number Receptacles <i>Bestellnummer Steckdose</i> |
|---|---------------------------|---------------------------------------|---------------------------------------|---|---------------------------------------|---|--|
| | | Mating Area <i>Steckbereich</i> | | Termination Area <i>Anschlussbereich</i> | | | |
| | | Inner Conductor <i>Innenleiter</i> | Outer Conductor <i>Außenleiter</i> | Inner Conductor <i>Innenleiter</i> | Outer Conductor <i>Außenleiter</i> | | |
| FBM004P154M | CuBe | 1,3 μm Au | 0,8 μm Au | 1,3 μm Au | 0,2 μm Au | T-Flex 405, Semi rigid 0.086 | FBM004S154U |
| FBM005P154M | CuBe | 1,3 μm Au | 0,8 μm Au | 1,3 μm Au | 0,2 μm Au | T-Flex 402, Semi rigid 0.141 | FBM005S154U |

Other platings on request / *Andere Oberflächen auf Anfrage*
Tools from page 9 onwards / *Werkzeuge ab Seite 94 ff.*

8 microinches = $\approx 0,2 \mu\text{m}$
30 microinches = $\approx 0,8 \mu\text{m}$

50 microinches = $\approx 1,3 \mu\text{m}$
200 microinches = $\approx 5 \mu\text{m}$

Dimensions

Abmessungen

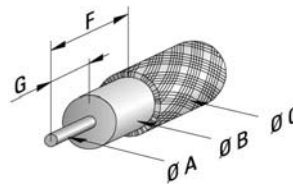
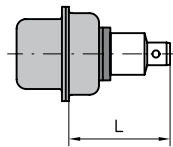

| Order Number <i>Bestellnummer</i> | Ø A max. | Ø B max. | Ø C max. | Ø D max. | F | G | H | J | L |
|--------------------------------------|-----------------|----------------|----------------|-------------|----------------|----------------|-----------------|-----------------|-----------------|
| FBM004P... | 0,55 (0.022) | 1,7 (0.067) | 2,3 (0.091) | — | 3,7 (0.146) | 3,1 (0.122) | 7,9 (0.311) | 10,0 (0.394) | 13,3 (0.524) |
| FBM004S... | 0,55 (0.022) | 1,7 (0.067) | 2,3 (0.091) | — | 3,7 (0.146) | 3,1 (0.122) | 8,1 (0.319) | 10,1 (0.398) | 13,5 (0.531) |
| FBM005P... | 0,97 (0.038) | — | 3,7 (0.146) | — | 2,3 (0.091) | 2,3 (0.091) | 10,6 (0.417) | 10,0 (0.394) | 16,0 (0.630) |
| FBM005S... | 0,97 (0.038) | — | 3,7 (0.146) | — | 2,3 (0.091) | 2,3 (0.091) | 10,8 (0.425) | 10,1 (0.398) | 16,2 (0.638) |



FBM Coaxial Contacts, 50 Ohm, Straight PCB Termination, 3 Pins

FBM Koaxialkontakte, 50 Ohm, gerader Leiterplattenanschluss, 3 Anschlüsse

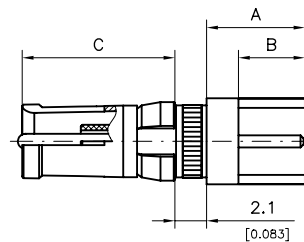
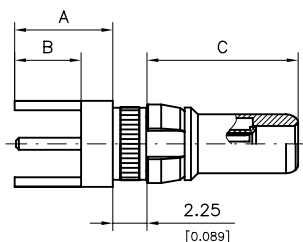

| Order Number Plug <i>Bestellnummer Stecker</i> | Type <i>Ausführung</i> | Platings / <i>Oberflächen</i> | | | | Order Number Receptacles <i>Bestellnummer Steckdose</i> | |
|---|---------------------------|---------------------------------------|---------------------------------------|---|---------------------------------------|---|-------------------------|
| | | Mating Area <i>Steckbereich</i> | | Termination Area <i>Anschlussbereich</i> | | | |
| | | Inner Conductor <i>Innenleiter</i> | Outer Conductor <i>Außenleiter</i> | Inner Conductor <i>Innenleiter</i> | Outer Conductor <i>Außenleiter</i> | | |
| FBM006P154MR | CuBe | 1,3 μm Au | 0,8 μm Au | 1,3 μm Au | 0,2 μm Au | FBM006S154UR | |
| Other platings on request / <i>Andere Oberflächen auf Anfrage</i> | | | | 8 microinches = ≈0,2 μm | 30 microinches = ≈0,8 μm | 50 microinches = ≈1,3 μm | 200 microinches = ≈5 μm |

Dimensions of an Example Connector with Coaxial Contact FBM006P.. and Signal Contacts P22

Abmessungen am Beispiel Steckverbinder mit Koaxialkontakt FBM006P..... und Signalkontakten P22

| Order Number <i>Bestellnummer</i> | A | B | C |
|--------------------------------------|----------------|----------------|-----------------|
| FBM006P...M | 6,5 (0.256) | 4,4 (0.173) | 10,0 (0.394) |
| FBM006S...U | 6,7 (0.264) | 4,4 (0.173) | 10,1 (0.398) |

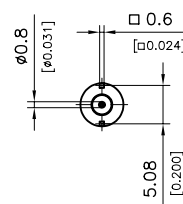
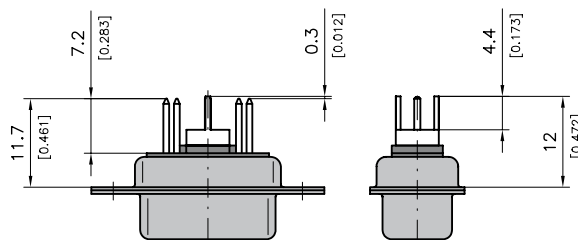

Side view without signal contacts!
Seitenansicht ohne Signalkontakte!



FBM Coaxial Contacts, 50 Ohm, Straight PCB Termination, 5 Pins

FBM Koaxialkontakte, 50 Ohm, gerader Leiterplattenanschluss, 5 Anschlüsse

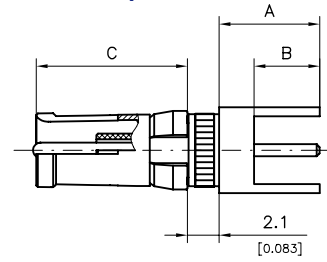
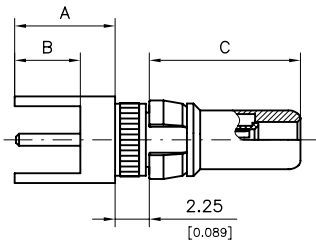

| Order Number Plug <i>Bestellnummer Stecker</i> | Type <i>Ausführung</i> | Platings / <i>Oberflächen</i> | | | | Order Number Receptacles <i>Bestellnummer Steckdose</i> |
|---|---------------------------|---------------------------------------|---------------------------------------|---|--|--|
| | | Mating Area <i>Steckbereich</i> | | Termination Area <i>Anschlussbereich</i> | | |
| | | Inner Conductor <i>Innenleiter</i> | Outer Conductor <i>Außenleiter</i> | Inner Conductor <i>Innenleiter</i> | Outer Conductor <i>Außenleiter</i> | |
| FBM007P154MR | CuBe | 1,3 μm Au | 0,8 μm Au | 1,3 μm Au | 0,2 μm Au | FBM007S154UR |
| Other platings on request / <i>Andere Oberflächen auf Anfrage</i> | | | | 8 microinches = $\approx 0,2 \mu\text{m}$ | 50 microinches = $\approx 1,3 \mu\text{m}$ | |
| | | | | 30 microinches = $\approx 0,8 \mu\text{m}$ | 200 microinches = $\approx 5 \mu\text{m}$ | |

Dimensions of an Example Connector with Coaxial Contact FBM007P... and Signal Contacts P22

Abmessungen am Beispiel Steckverbinder mit Koaxialkontakt FBM007P... und Signalkontakten P22

| Order Number <i>Bestellnummer</i> | A | B | C |
|--------------------------------------|----------------|----------------|-----------------|
| FBM007P...M | 6,5 (0.256) | 4,4 (0.173) | 10,0 (0.394) |
| FBM007S...U | 6,7 (0.264) | 4,4 (0.173) | 10,1 (0.398) |

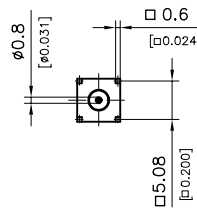
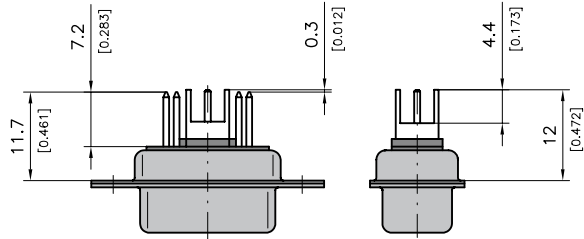

Side view without signal contacts!
Seitenansicht ohne Signalkontakte!



FBM Coaxial Contacts, 50 Ohm, Right Angled PCB Termination, 3 Pins

FBM Koaxialkontakte, 50 Ohm, abgewinkelter Leiterplattenanschluss, 3 Anschlüsse

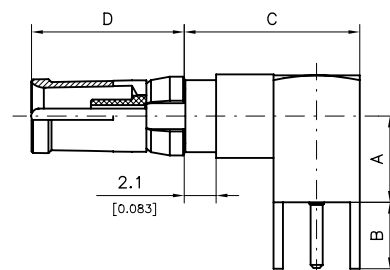
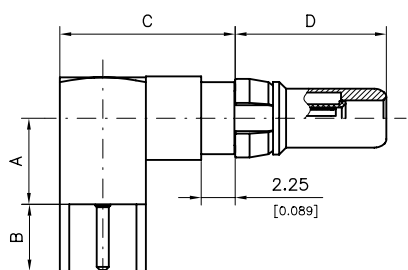

| Order Number Plug <i>Bestellnummer Stecker</i> | Type <i>Ausführung</i> | Platings / <i>Oberflächen</i> | | | | Order Number Receptacles <i>Bestellnummer Steckdose</i> |
|--|---------------------------|---------------------------------------|---------------------------------------|---|---------------------------------------|---|
| | | Mating Area <i>Steckbereich</i> | | Termination Area <i>Anschlussbereich</i> | | |
| | | Inner Conductor <i>Innenleiter</i> | Outer Conductor <i>Außenleiter</i> | Inner Conductor <i>Innenleiter</i> | Outer Conductor <i>Außenleiter</i> | |
| FBM001P154MR | CuBe | 1,3 μm Au | 0,8 μm Au | 1,3 μm Au | 0,2 μm Au | FBM001S154UR |

Other platings on request / *Andere Oberflächen auf Anfrage*

8 microinches = ≈0,2 μm
30 microinches = ≈0,8 μm

50 microinches = ≈1,3 μm
200 microinches = ≈5 μm

Dimensions of an Example Connector with Coaxial Contacts FBM001P... and Signal Contacts P5

Abmessungen am Beispiel Steckverbinder mit Koaxialkontakten FBM001P... und Signalkontakten P5

| Order Number <i>Bestellnummer</i> | A | B | C | D |
|--------------------------------------|----------------|----------------|-----------------|-----------------|
| FBM001P...M | 5,7 (0.224) | 4,4 (0.173) | 11,6 (0.457) | 10,0 (0.394) |
| FBM001S...U | 5,7 (0.224) | 4,4 (0.173) | 11,6 (0.457) | 10,1 (0.398) |

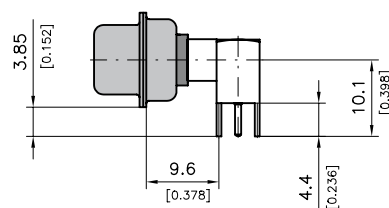
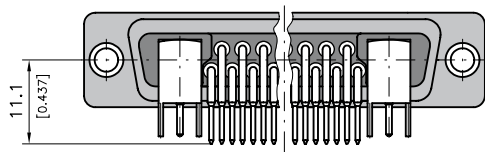
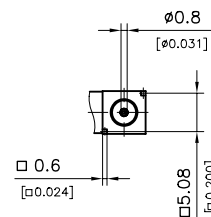

Side view without signal contacts!
Seitenansicht ohne Signalkontakte!

Mouser Electronics

Authorized Distributor

Click to View Pricing, Inventory, Delivery & Lifecycle Information:

[Molex:](#)

[FMX012S102](#) [FMX-008P102](#) [FMX-008S102](#) [FME005S102](#) [FME009S102](#) [FMS026S102](#) [FMS012P102](#)

Компания «Life Electronics» занимается поставками электронных компонентов импортного и отечественного производства от производителей и со складов крупных дистрибьюторов Европы, Америки и Азии.

С конца 2013 года компания активно расширяет линейку поставок компонентов по направлению коаксиальный кабель, кварцевые генераторы и конденсаторы (керамические, пленочные, электролитические), за счёт заключения дистрибьюторских договоров

Мы предлагаем:

- Конкурентоспособные цены и скидки постоянным клиентам.
- Специальные условия для постоянных клиентов.
- Подбор аналогов.
- Поставку компонентов в любых объемах, удовлетворяющих вашим потребностям.
- Приемлемые сроки поставки, возможна ускоренная поставка.
- Доставку товара в любую точку России и стран СНГ.
- Комплексную поставку.
- Работу по проектам и поставку образцов.
- Формирование склада под заказчика.
- Сертификаты соответствия на поставляемую продукцию (по желанию клиента).
- Тестирование поставляемой продукции.
- Поставку компонентов, требующих военную и космическую приемку.
- Входной контроль качества.
- Наличие сертификата ISO.

В составе нашей компании организован Конструкторский отдел, призванный помогать разработчикам, и инженерам.

Конструкторский отдел помогает осуществить:

- Регистрацию проекта у производителя компонентов.
- Техническую поддержку проекта.
- Защиту от снятия компонента с производства.
- Оценку стоимости проекта по компонентам.
- Изготовление тестовой платы монтаж и пусконаладочные работы.



Тел: +7 (812) 336 43 04 (многоканальный)

Email: org@lifeelectronics.ru