

FEATURES

- Ultra Broad Bandwidth : 50 MHz to 50 GHz
- Functional Bandwidth : 50 MHz to 70 GHz
- 0.3 dB Insertion Loss
- 46 dB Isolation at 50 GHz
- Low Current consumption
 - -5V for low loss state
 - +10mA for Isolation state
- M/A-COM Tech's unique AlGaAs hetero-junction anode technology
- Silicon Nitride Passivation
- Polymer Scratch protection
- RoHS Compliant* and 260°C Reflow Compatible

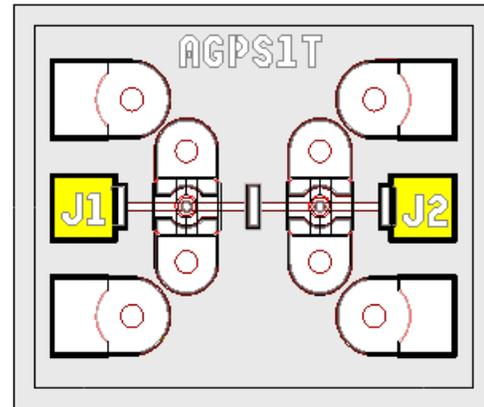

Yellow areas indicate bond pads

DESCRIPTION

The MA4AGSW1 is an Aluminum-Gallium-Arsenide, single pole, single throw (SPST), PIN diode switch. The switch features enhanced AlGaAs anodes which are formed using M/A-COM Tech's patented hetero-junction technology. This technology produces a switch with less loss than conventional GaAs processes. As much as a 0.3 dB reduction in insertion loss can be realized at 50GHz. These devices are fabricated on an OMCVD epitaxial wafer using a process designed for high device uniformity and extremely low parasitics. The diodes themselves exhibit low series resistance, low capacitance, and fast switching speed. They are fully passivated with silicon nitride and have an additional polymer layer for scratch protection. The protective coating prevents damage to the diode junction and anode air-bridges during handling and assembly. Off chip bias circuitry is required.

APPLICATIONS

The high electron mobility of AlGaAs and the low capacitance of the PIN diodes makes this switch ideal for fast switching, high frequency, multi-throw switch designs. These AlGaAs PIN switches are use in switching arrays for radar systems, radiometers, test equipment and other multi-assembly components.

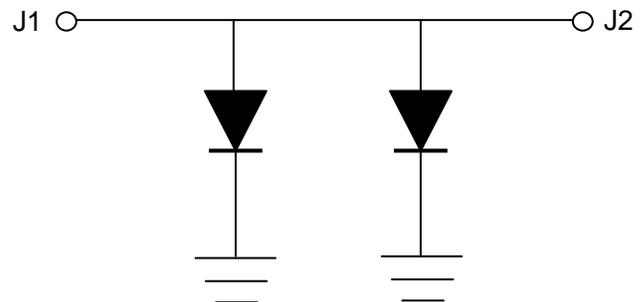

Absolute Maximum Ratings @ T_{AMB} = +25°C

Parameter	Maximum Rating
Operating Temperature	-55°C to +125°C
Storage Temperature	-55°C to +150°C
Incident C.W. RF Power	+23dBm C.W.
Breakdown Voltage	25V
Bias Current	± 25mA
Junction Temperature	+150°C

Maximum combined operating conditions for RF Power, D.C. bias, and temperature: +23 dBm C.W. @ 10 mA (per diode) @ +85°C.

* Restrictions on Hazardous Substances, European Union Directive 2002/95/EC.

**Electrical Specifications @ T_{AMB} = 25°C
(On-wafer measurements)**

PARAMETER	FREQUENCY BAND	MIN	TYP	MAX	UNITS
INSERTION LOSS @ -5V	0.05 - 18GHz	---	0.2	0.3	dB
	18 - 50GHz	---	0.3	0.6	dB
ISOLATION @ +10mA	0.05 - 18GHz	20	22	---	dB
	18 - 50GHz	40	46	---	dB
INPUT RETURN LOSS @ -5V	0.05 - 18GHz	---	30	---	dB
	18 - 50GHz	---	16	---	dB
OUTPUT RETURN LOSS @ -5V	0.05 - 18GHz	---	30	---	dB
	18 - 50GHz	---	16	---	dB
SWITCHING SPEED* (10 % - 90 % RF VOLTAGE)	10GHz	---	10	---	nS

***Note:**

Typical switching speed is measured from 10% to 90% of the detected RF voltage driven by a TTL compatible driver. Driver output parallel RC network uses a capacitor between 390 pF - 560 pF and a resistor between 150 - 220 Ohms to achieve 10 ns rise and fall times.

Typical RF Performance (Probed on Wafer)

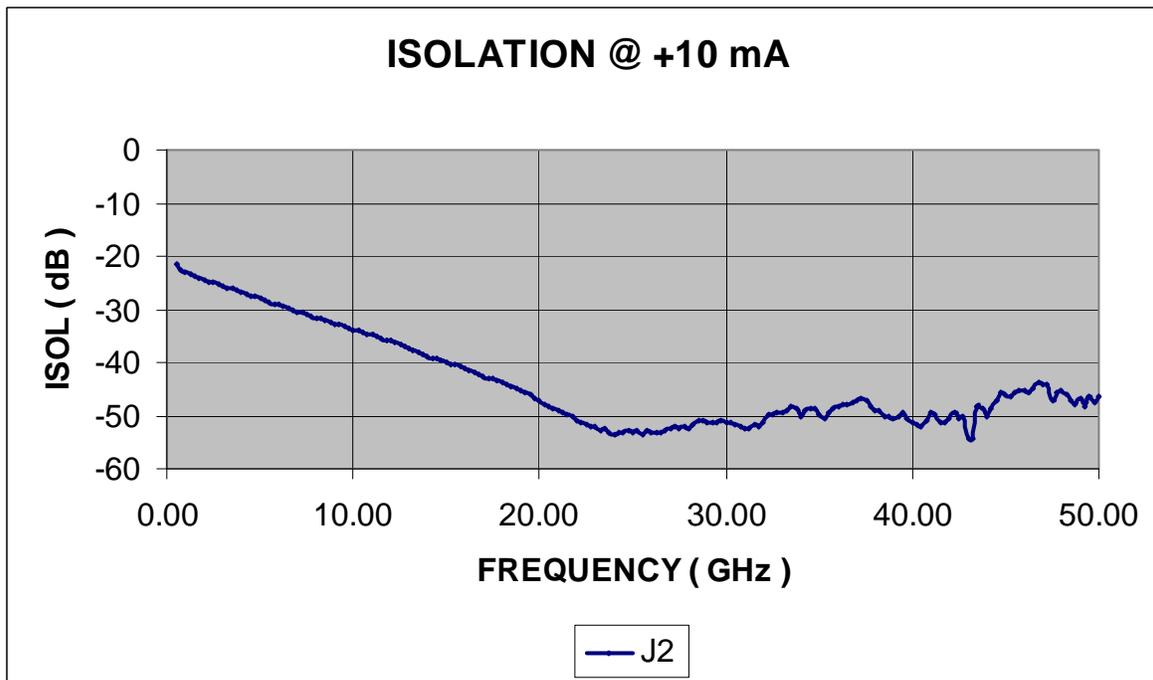
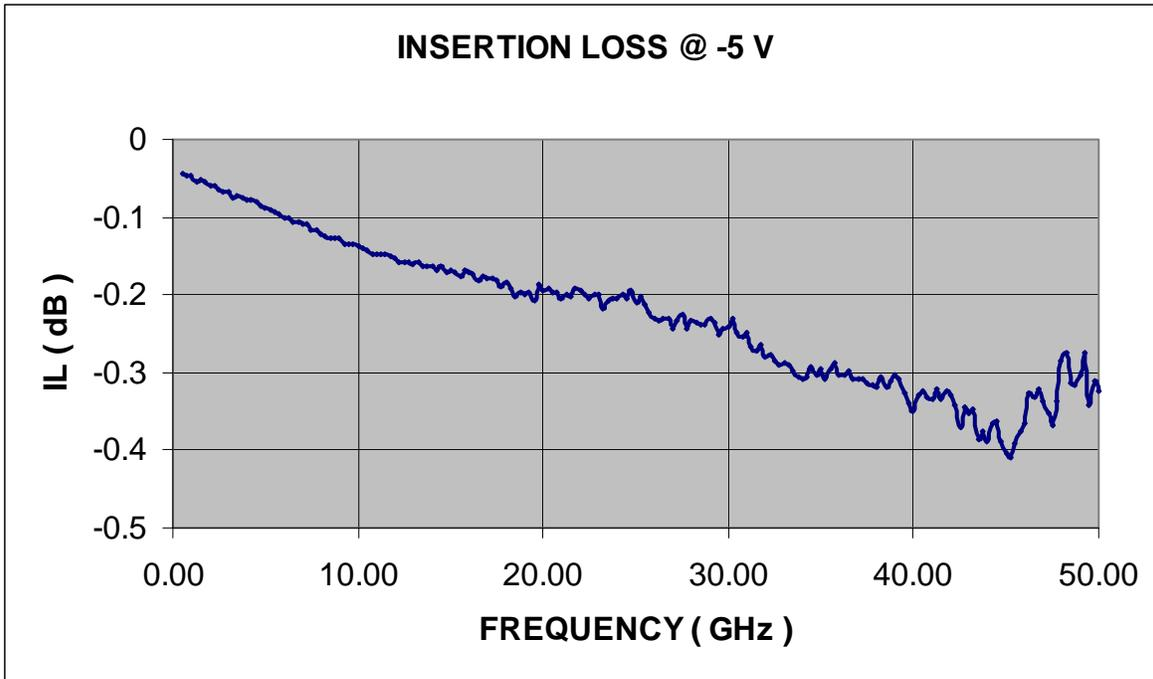

Typical RF Performance (Probed on wafer)

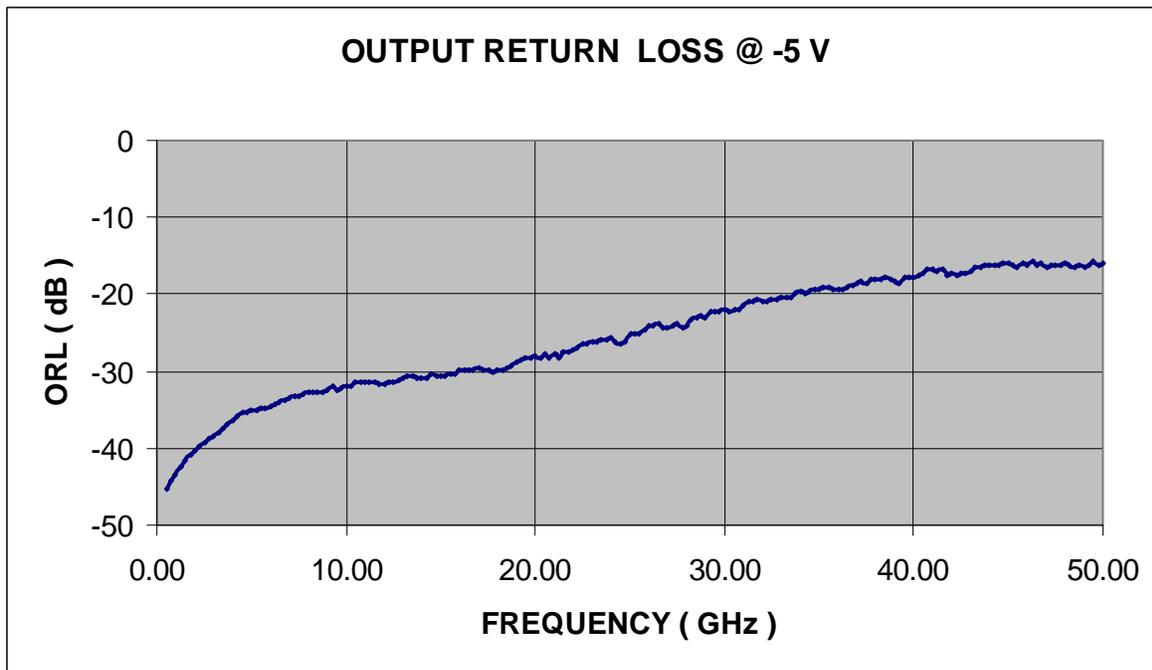
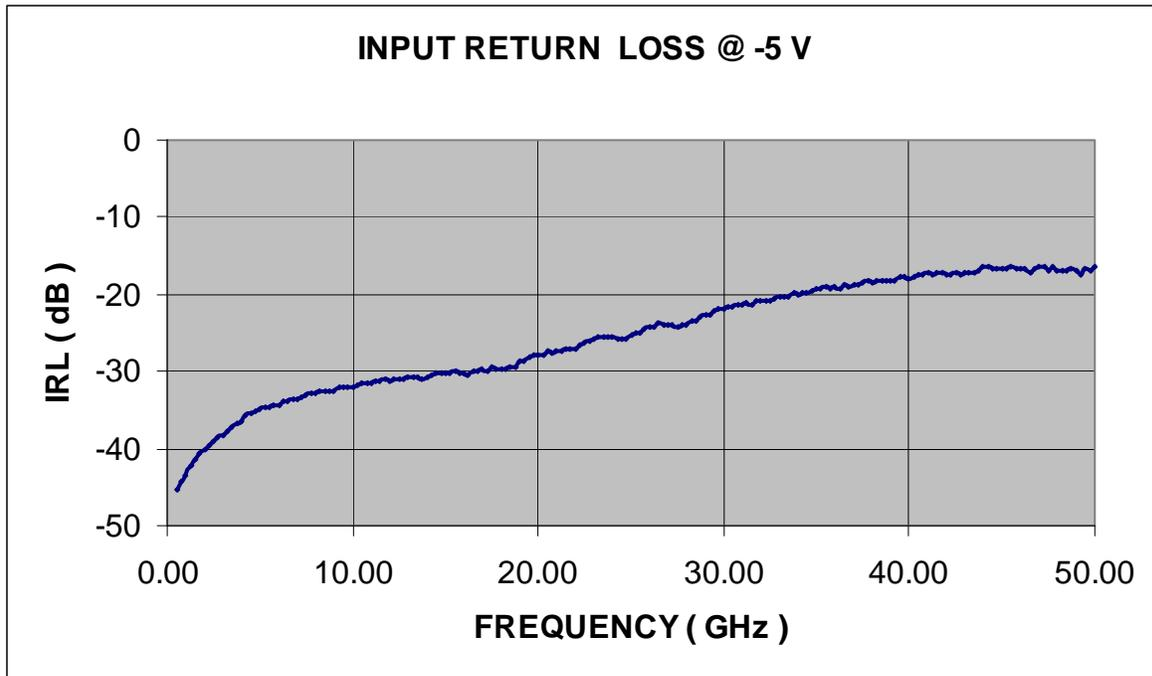

Operation of the MA4AGSW1 Switch

The application of 0V or a negative DC voltage to either J1 or J2 provides insertion loss for the MA4AGSW1 SPST reflective switch. Isolation is achieved with +10 mA total D.C. current. The forward bias voltage at the diode bias node is typically 1.4 volts for supply currents up to +30 mA and will not exceed 1.6 volts. The backside area of the die is the RF and DC return ground plane. The bias network design should yield >30 dB RF to DC isolation.

Available for use in conjunction with M/A-COM Tech's line of AlGaAs switches are two, fully integrated, broadband, monolithic, bias networks which may be used as an alternative to the suggested individual component bias network shown below. Refer to datasheets for the [MA4BN1840-1](#) and [MA4BN1840-2](#) for additional information.

The lowest insertion loss, P1dB, IP³, and switching speed is achieved by applying a minimum value of | -2V | at D.C. Bias node, which is achievable with a standard, ± 5V TTL Controlled PIN Diode Driver.

MA4AGSW1 Schematic with 2-18 GHz Bias Network

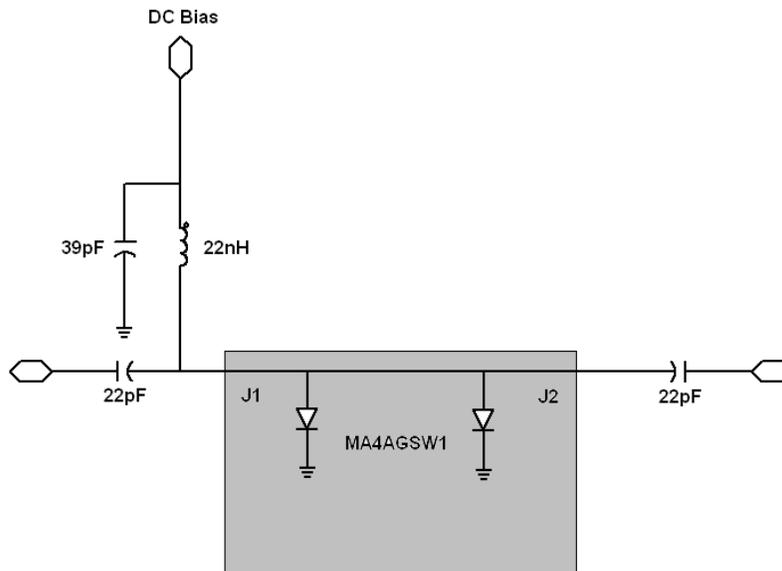

Note: The bias network can be connected to either J1 or J2

TYPICAL DRIVER CONNECTIONS

CONTROL LEVEL (DC CURRENT)	RF OUTPUT STATE
J1 or J2	J1-J2
-5V	Low Loss
+10mA	Isolation

Chip Dimensions and Bonding Pad Locations (In Yellow)

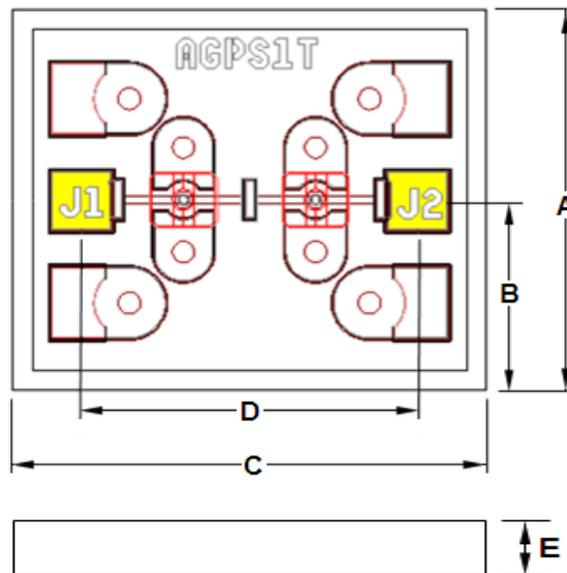

DIM	Mils		Millimeters	
	Min.	Max.	Min.	Max.
A	23.5	25.5	.597	.648
B	14.25	15.25	.362	.387
C	28.50	30.50	.724	.775
D	20.50	21.00	.521	.533
E	3.50	4.50	.089	.114
Pads X-Y	3.50	4.50	.089	.114

ASSEMBLY INSTRUCTIONS

CLEANLINESS

These chips should be handled in a clean environment.

STATIC SENSITIVITY

These Devices are considered ESD Class 0 HBM. Proper ESD techniques should be used when handling these devices.

GENERAL HANDLING

The protective polymer coating on the active areas of the die provides scratch and impact protection, particularly for the metal air bridge, which contacts the diode's anode. Die should primarily be handled with vacuum pickups, or alternatively with plastic tweezers.

ASSEMBLY TECHNIQUES

The MA4AGSW1, AlGaAs switch is designed to be mounted with electrically conductive silver epoxy or with a lower temperature solder perform, which does not have a rich tin content.

SOLDER DIE ATTACH

All die attach and bonding methods should be compatible with gold metal. Solder which does not scavenge gold, such as 80/20, Au/Sn or Indalloy #2 is recommended. Do not expose die to temperatures greater than 300°C for more than 10 seconds.

ELECTRICAL CONDUCTIVE EPOXY DIE ATTACH

Use a controlled thickness of approximately 2 mils for best electrical conductivity and lowest thermal resistance. Cure epoxy per manufacturer's schedule. Typically 150°C for 1 hour.

RIBBON/WIRE BONDING

Thermo-compression wedge or ball bonding may be used to attach ribbons or wire to the gold bonding pads. A 1/4 x 3 mil gold ribbon is recommended on all RF ports and should be kept as short as possible for the lowest inductance and best microwave performance. For more detailed handling and assembly instructions, see [Application Note M541](#), "Bonding and Handling Procedures for Chip Diode Devices" at www.macomtech.com.

Ordering Information

Part Number	Package
MA4AGSW1	Waffle Pack

Компания «Life Electronics» занимается поставками электронных компонентов импортного и отечественного производства от производителей и со складов крупных дистрибьюторов Европы, Америки и Азии.

С конца 2013 года компания активно расширяет линейку поставок компонентов по направлению коаксиальный кабель, кварцевые генераторы и конденсаторы (керамические, пленочные, электролитические), за счёт заключения дистрибьюторских договоров

Мы предлагаем:

- Конкурентоспособные цены и скидки постоянным клиентам.
- Специальные условия для постоянных клиентов.
- Подбор аналогов.
- Поставку компонентов в любых объемах, удовлетворяющих вашим потребностям.
- Приемлемые сроки поставки, возможна ускоренная поставка.
- Доставку товара в любую точку России и стран СНГ.
- Комплексную поставку.
- Работу по проектам и поставку образцов.
- Формирование склада под заказчика.
- Сертификаты соответствия на поставляемую продукцию (по желанию клиента).
- Тестирование поставляемой продукции.
- Поставку компонентов, требующих военную и космическую приемку.
- Входной контроль качества.
- Наличие сертификата ISO.

В составе нашей компании организован Конструкторский отдел, призванный помогать разработчикам, и инженерам.

Конструкторский отдел помогает осуществить:

- Регистрацию проекта у производителя компонентов.
- Техническую поддержку проекта.
- Защиту от снятия компонента с производства.
- Оценку стоимости проекта по компонентам.
- Изготовление тестовой платы монтаж и пусконаладочные работы.



Тел: +7 (812) 336 43 04 (многоканальный)
Email: org@lifeelectronics.ru