

TELUX LED

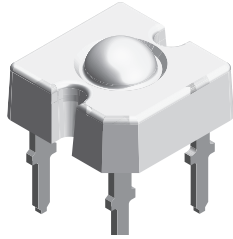

DESCRIPTION

The TELUX series is a clear, non diffused LED for applications where supreme luminous flux is required. It is designed in an industry standard 7.62 mm square package utilizing highly developed AllnGaP technology. The supreme heat dissipation of TELUX™ allows applications at high ambient temperatures. All packing units are binned for luminous flux, forward voltage and color to achieve the most homogenous light appearance in application. SAE and ECE color requirements for automobile application are available for color red.

PRODUCT GROUP AND PACKAGE DATA

- Product group: LED
- Package: TELUX
- Product series: power
- Angle of half intensity: $\pm 45^\circ$

FEATURES

- High luminous flux
- Supreme heat dissipation: R_{thJP} is 90 K/W
- High operating temperature:
 $T_{amb} = -40^\circ\text{C}$ to $+110^\circ\text{C}$
- Meets SAE and ECE color requirements for the automobile industry for color red
- Packed in tubes for automatic insertion
- Luminous flux, forward voltage and color categorized for each tube
- Small mechanical tolerances allow precise usage of external reflectors or lightguides
- Compatible with wave solder processes according to CECC 00802
- ESD-withstand voltage: up to 2 kV according to JESD22-A114-B
- AEC-Q101 qualified
- Compliant to RoHS Directive 2002/95/EC and in accordance to WEEE 2002/96/EC



APPLICATIONS

- Exterior lighting
- Dashboard illumination
- Tail-, stop- and turn signals of motor vehicles
- Replaces small incandescent lamps
- Traffic signals and signs

PARTS TABLE

PART	COLOR	LUMINOUS FLUX (mlm)			at I_F (mA)	WAVELENGTH (nm)			FORWARD VOLTAGE (V)			TECHNOLOGY
		MIN.	TYP.	MAX.		MIN.	TYP.	MAX.	MIN.	TYP.	MAX.	
TLWR8900	Red	2000	3000	-	70	611	615	634	1.83	2.2	2.67	AllnGaP on GaAs
TLWR8901	Red	2000	3000	4800	70	611	615	634	1.83	2.2	2.67	AllnGaP on GaAs
TLWR8902	Red	3000	-	4800	70	611	615	634	1.95	2.2	2.67	AllnGaP on GaAs
TLWR8903	Red	2500	-	4200	70	611	615	634	1.83	2.2	2.67	AllnGaP on GaAs
TLWY8900	Yellow	2000	3000	-	70	585	590	597	1.83	2.1	2.67	AllnGaP on GaAs

ABSOLUTE MAXIMUM RATINGS ($T_{amb} = 25^\circ\text{C}$, unless otherwise specified) TLWR8900, TLWR8901, TLWR8902, TLWR8903, TLWY8900

PARAMETER	TEST CONDITION	SYMBOL	VALUE	UNIT
Reverse voltage ⁽¹⁾	$I_R = 100 \mu\text{A}$	V_R	10	V
DC forward current	$T_{amb} \leq 85^\circ\text{C}$	I_F	70	mA
Surge forward current	$t_p \leq 10 \mu\text{s}$	I_{FSM}	1	A
Power dissipation		P_V	187	mW
Junction temperature		T_j	125	$^\circ\text{C}$
Operating temperature range		T_{amb}	- 40 to + 110	$^\circ\text{C}$
Storage temperature range		T_{stg}	- 55 to + 110	$^\circ\text{C}$
Soldering temperature	$t \leq 5 \text{ s}$, 1.5 mm from body preheat temperature $100^\circ\text{C}/30 \text{ s}$	T_{sd}	260	$^\circ\text{C}$
Thermal resistance junction/ambient	With cathode heatsink of 70 mm^2	R_{thJA}	200	K/W
Thermal resistance junction/pin		R_{thJP}	90	K/W

Note

⁽¹⁾ Driving the LED in reverse direction is suitable for a short term application

** Please see document "Vishay Material Category Policy": www.vishay.com/doc?99902



OPTICAL AND ELECTRICAL CHARACTERISTICS (T _{amb} = 25 °C, unless otherwise specified) TLWR8900, TLWR8901, TLWR8902, TLWR8903, RED							
PARAMETER	TEST CONDITION	PART	SYMBOL	MIN.	TYP.	MAX.	UNIT
Total flux	I _F = 70 mA, R _{thJA} = 200 K/W	TLWR8900	φ _V	2000	3000	-	mlm
	I _F = 70 mA, R _{thJA} = 200 K/W	TLWR8901	φ _V	2000	3000	4800	mlm
	I _F = 70 mA, R _{thJA} = 200 K/W	TLWR8902	φ _V	3000	-	4800	mlm
	I _F = 70 mA, R _{thJA} = 200 K/W	TLWR8903	φ _V	2500	-	4200	mlm
Luminous intensity/total flux			I _V /φ _V	-	0.7	-	mcd/mlm
Dominant wavelength			λ _d	611	615	634	nm
Peak wavelength			λ _p	-	624	-	nm
Angle of half intensity			φ	-	± 45	-	deg
Total included angle	90 % of total flux captured		φ _{0.9 V}	-	100	-	deg
Forward voltage	I _F = 70 mA, R _{thJA} = 200 K/W	TLWR8900	V _F	1.83	2.2	2.67	V
	I _F = 70 mA, R _{thJA} = 200 K/W	TLWR8901	V _F	1.83	2.2	2.67	V
	I _F = 70 mA, R _{thJA} = 200 K/W	TLWR8902	V _F	1.95	2.2	2.67	V
	I _F = 70 mA, R _{thJA} = 200 K/W	TLWR8903	V _F	1.83	2.2	2.67	V
Reverse voltage	I _R = 10 μA		V _R	10	20	-	V
Junction capacitance	V _R = 0, f = 1 MHz		C _j	-	17	-	pF

OPTICAL AND ELECTRICAL CHARACTERISTICS (T _{amb} = 25 °C, unless otherwise specified) TLWY8900, YELLOW							
PARAMETER	TEST CONDITION	PART	SYMBOL	MIN.	TYP.	MAX.	UNIT
Total flux	I _F = 70 mA, R _{thJA} = 200 K/W		φ _V	2000	3000	-	mlm
Luminous intensity/total flux	I _F = 70 mA, R _{thJA} = 200 K/W		I _V /φ _V	-	0.7	-	mcd/mlm
Dominant wavelength	I _F = 70 mA, R _{thJA} = 200 K/W		λ _d	585	590	597	nm
Peak wavelength	I _F = 70 mA, R _{thJA} = 200 K/W		λ _p	-	594	-	nm
Angle of half intensity	I _F = 70 mA, R _{thJA} = 200 K/W		φ	-	± 45	-	deg
Total included angle	90 % of total flux captured		φ _{0.9 V}	-	100	-	deg
Forward voltage	I _F = 70 mA, R _{thJA} = 200 K/W		V _F	1.83	2.1	2.67	V
Reverse voltage	I _R = 10 μA		V _R	10	15	-	V
Junction capacitance	V _R = 0, f = 1 MHz		C _j	-	17	-	pF

LUMINOUS FLUX CLASSIFICATION		
GROUP	LUMINOUS FLUX (mlm)	
	MIN.	MAX.
D	2000	3000
E	2500	3600
F	3000	4200
G	3500	4800
H	4000	6100
I	5000	7300
K	6000	9700
L	7000	12 200
M	8000	15 000

Note

- Luminous flux is tested at a current pulse duration of 25 ms and an accuracy of ± 11 %.
These type numbers represent the order groups which include only a few brightness groups. Only one group will be shipped on each tube (there will be no mixing of two groups on each tube).

In order to ensure availability, single brightness groups will not be orderable.

In a similar manner for colors where wavelength groups are measured and binned, single wavelength groups will be shipped in any one tube.

In order to ensure availability, single wavelength groups will not be orderable.



COLOR CLASSIFICATION				
GROUP	DOM. WAVELENGTH (nm)			
	YELLOW		RED	
	MIN.	MAX.	MIN.	MAX.
0	585	588		
1	587	591	611	618
2	589	594	614	622
3	592	597	616	634

FORWARD VOLTAGE CLASSIFICATION		
GROUP	FORWARD VOLTAGE (V)	
	MIN.	MAX.
Y	1.83	2.07
Z	1.95	2.19
0	2.07	2.31
1	2.19	2.43
2	2.31	2.55
3	2.43	2.67

Note

- Wavelengths are tested at a current pulse duration of 25 ms and an accuracy of ± 1 nm.

TYPICAL CHARACTERISTICS ($T_{amb} = 25\text{ }^{\circ}\text{C}$, unless otherwise specified)

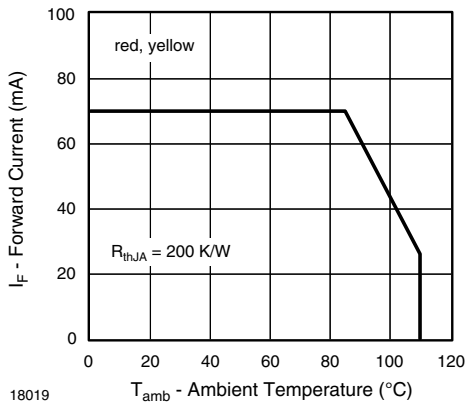

Fig. 1 - Forward Current vs. Ambient Temperature

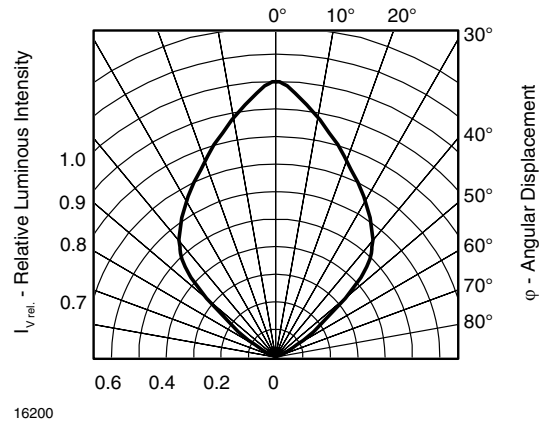

Fig. 3 - Rel. Luminous Intensity vs. Angular Displacement

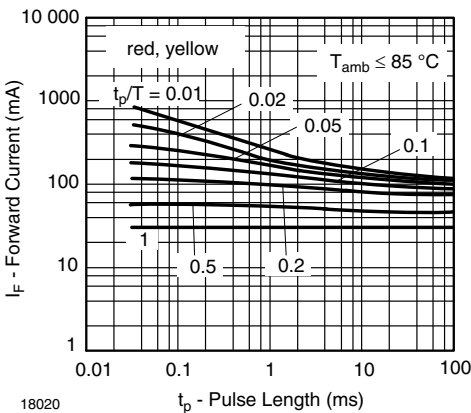

Fig. 2 - Forward Current vs. Pulse Length

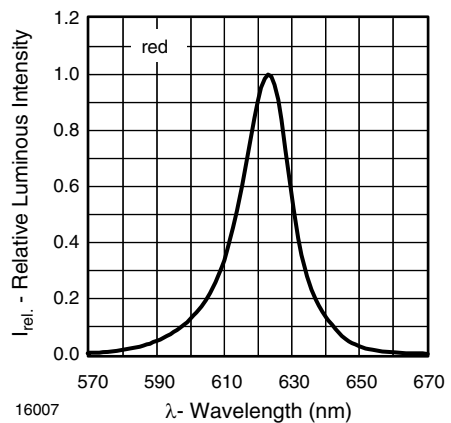

Fig. 4 - Relative Intensity vs. Wavelength

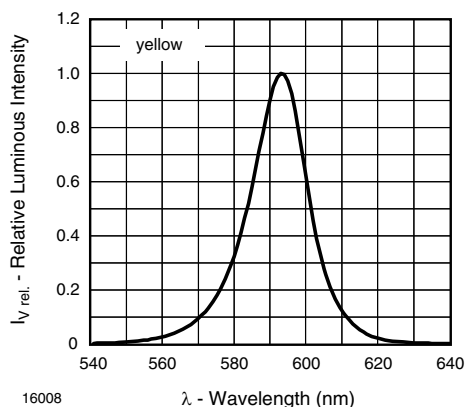

Fig. 5 - Relative Intensity vs. Wavelength

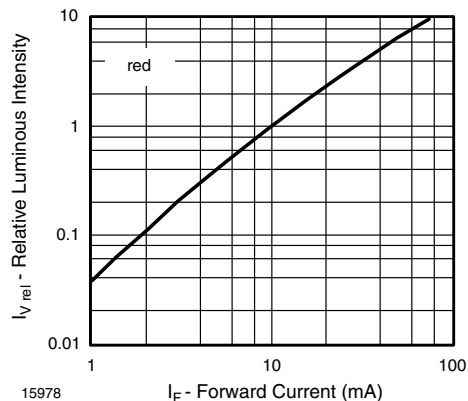

Fig. 8 - Relative Luminous Flux vs. Forward Current

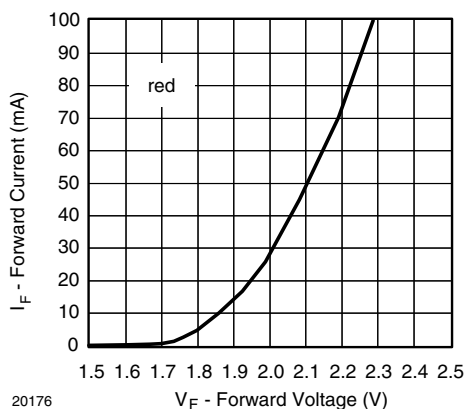

Fig. 6 - Forward Current vs. Forward Voltage

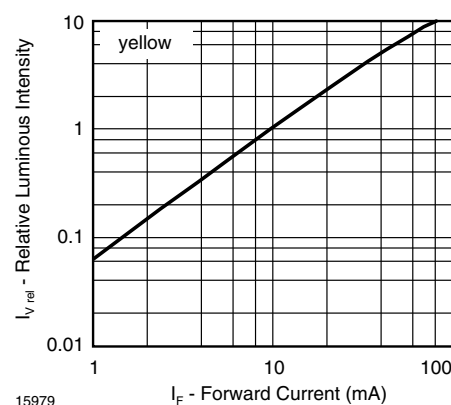

Fig. 9 - Relative Luminous Flux vs. Forward Current

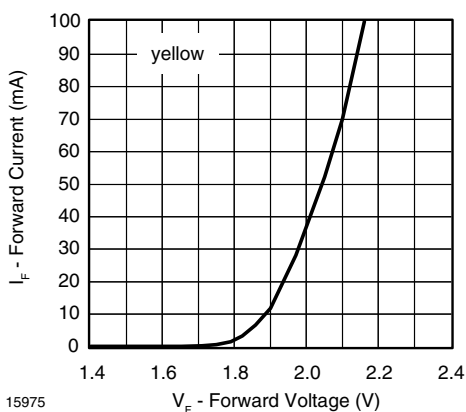

Fig. 7 - Forward Current vs. Forward Voltage

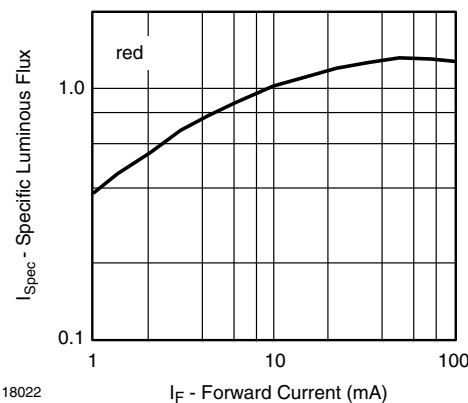

Fig. 10 - Specific Luminous Flux vs. Forward Current

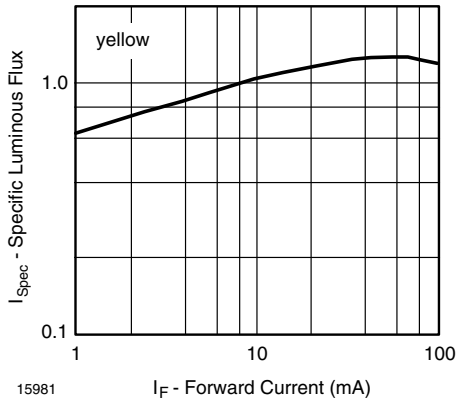

Fig. 11 - Specific Luminous Flux vs. Forward Current

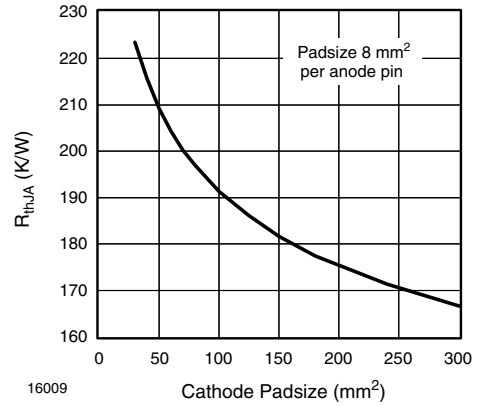

Fig. 14 - Thermal Resistance Junction Ambient vs. Cathode Padsizes

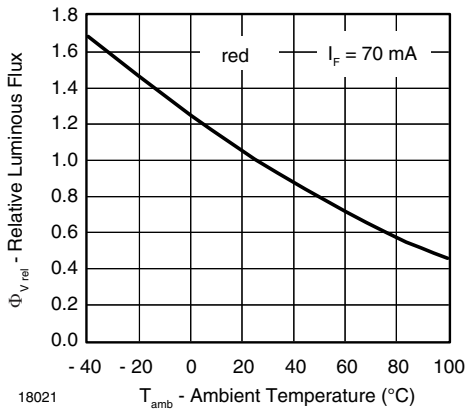

Fig. 12 - Rel. Luminous Flux vs. Ambient Temperature

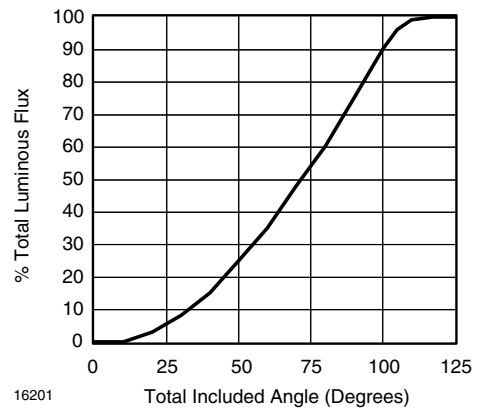

Fig. 15 - Percentage Total Luminous Flux vs. Total Included Angle for 90° Emission Angle

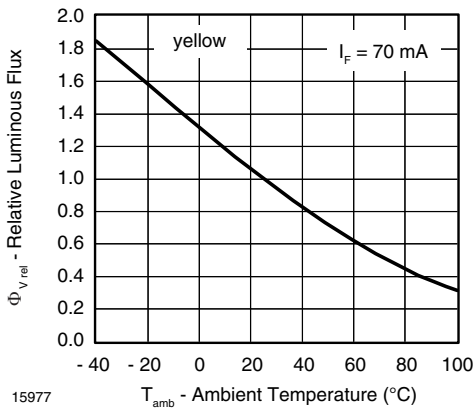
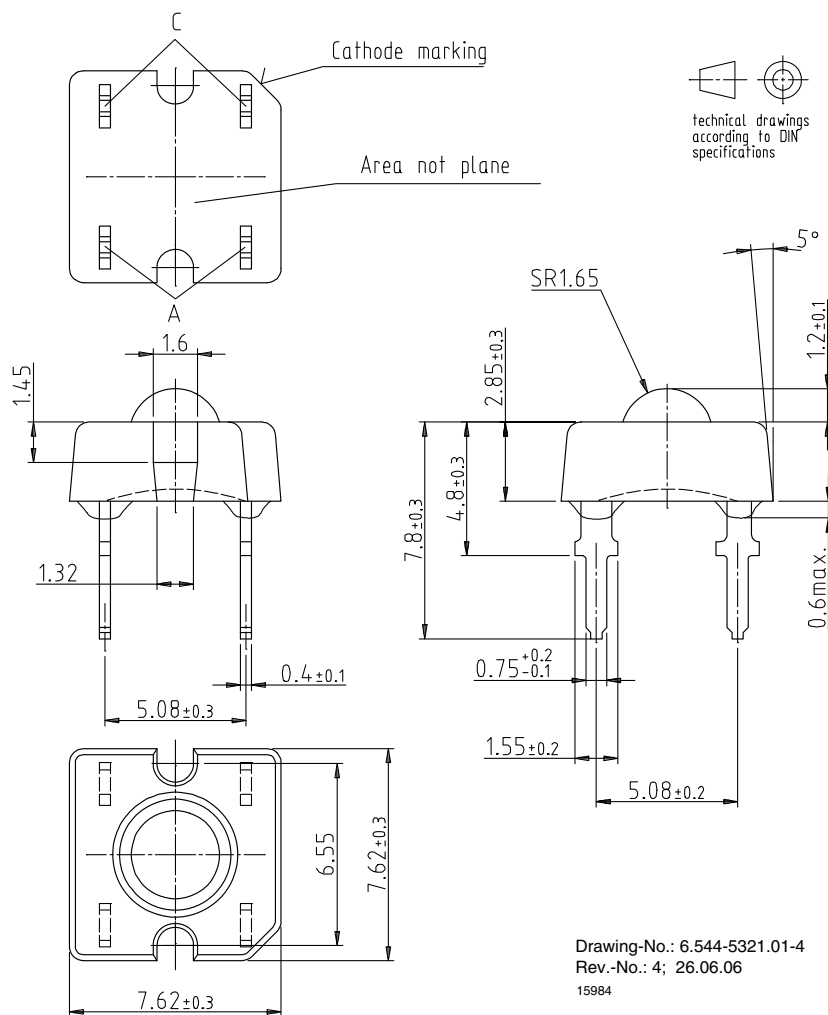
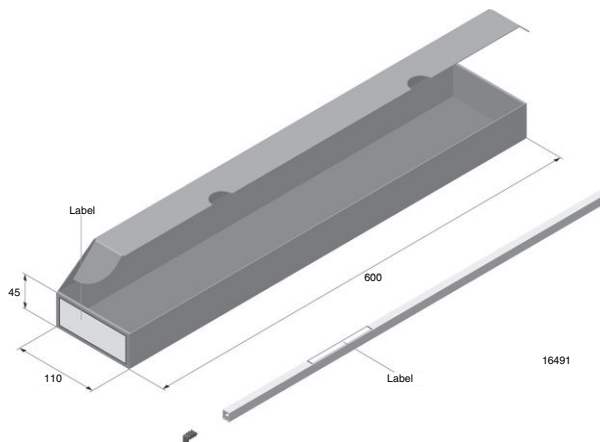

Fig. 13 - Rel. Luminous Flux vs. Ambient Temperature

PACKAGE DIMENSIONS in millimeters



FAN FOLD BOX DIMENSIONS in millimeters





LABEL OF FAN FOLD BOX (EXAMPLE)

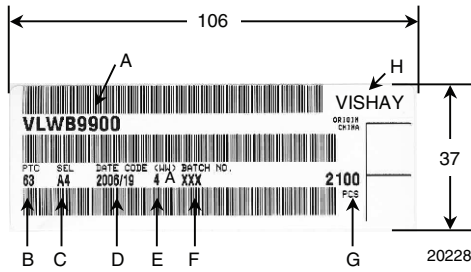

- A. Type of component
- B. Manufacturing plant
- C. SEL - selection code (bin):
e.g.: A = code for luminous intensity group
4 = code for color group
- D. Date code year/week
- E. Day code (e.g. 4: Thursday, A: early shift)
- F. Batch no.
- G. Total quantity
- H. Company code

EXAMPLE FOR TELUX TUBE LABEL DIMENSIONS in millimeters

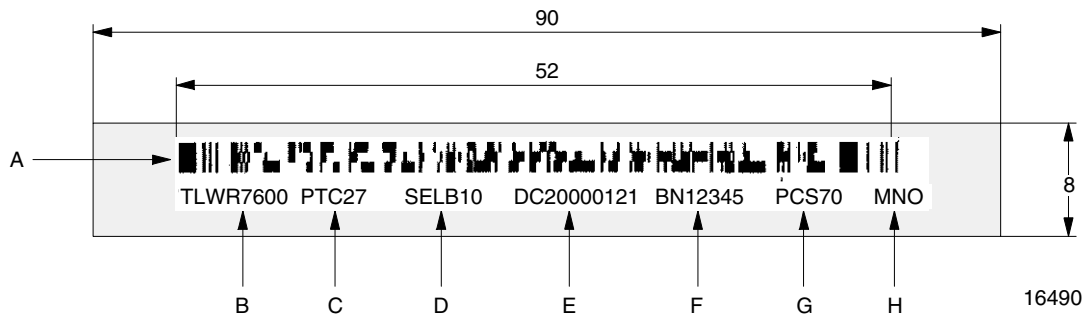

- A. Bar code
- B. Type of component
- C. Manufacturing plant
- D. SEL - selection code (bin):
digit 1 - code for luminous flux group
digit 2 - code for dominant wavelength group
digit 3 - code for forward voltage group
- E. Date code
- F. Batch no.
- G. Total quantity
- H. Company code

TUBE WITH BAR CODE LABEL DIMENSIONS in millimeters

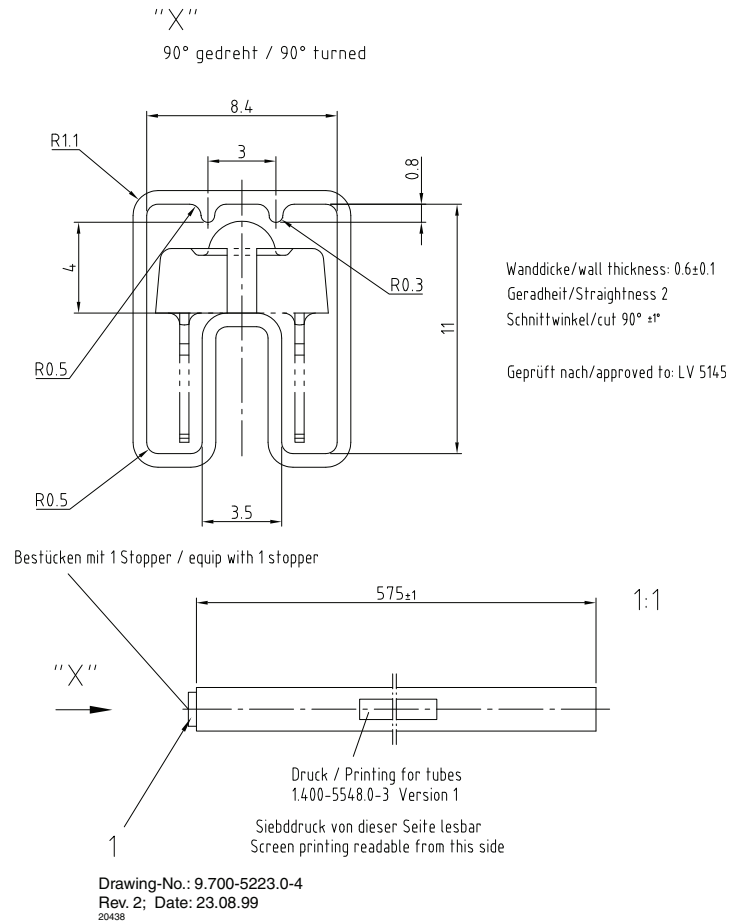

Fig. 16 - Drawing Proportions not Scaled



Disclaimer

ALL PRODUCT, PRODUCT SPECIFICATIONS AND DATA ARE SUBJECT TO CHANGE WITHOUT NOTICE TO IMPROVE RELIABILITY, FUNCTION OR DESIGN OR OTHERWISE.

Vishay Intertechnology, Inc., its affiliates, agents, and employees, and all persons acting on its or their behalf (collectively, "Vishay"), disclaim any and all liability for any errors, inaccuracies or incompleteness contained in any datasheet or in any other disclosure relating to any product.

Vishay makes no warranty, representation or guarantee regarding the suitability of the products for any particular purpose or the continuing production of any product. To the maximum extent permitted by applicable law, Vishay disclaims (i) any and all liability arising out of the application or use of any product, (ii) any and all liability, including without limitation special, consequential or incidental damages, and (iii) any and all implied warranties, including warranties of fitness for particular purpose, non-infringement and merchantability.

Statements regarding the suitability of products for certain types of applications are based on Vishay's knowledge of typical requirements that are often placed on Vishay products in generic applications. Such statements are not binding statements about the suitability of products for a particular application. It is the customer's responsibility to validate that a particular product with the properties described in the product specification is suitable for use in a particular application. Parameters provided in datasheets and/or specifications may vary in different applications and performance may vary over time. All operating parameters, including typical parameters, must be validated for each customer application by the customer's technical experts. Product specifications do not expand or otherwise modify Vishay's terms and conditions of purchase, including but not limited to the warranty expressed therein.

Except as expressly indicated in writing, Vishay products are not designed for use in medical, life-saving, or life-sustaining applications or for any other application in which the failure of the Vishay product could result in personal injury or death. Customers using or selling Vishay products not expressly indicated for use in such applications do so at their own risk. Please contact authorized Vishay personnel to obtain written terms and conditions regarding products designed for such applications.

No license, express or implied, by estoppel or otherwise, to any intellectual property rights is granted by this document or by any conduct of Vishay. Product names and markings noted herein may be trademarks of their respective owners.

Material Category Policy

Vishay Intertechnology, Inc. hereby certifies that all its products that are identified as RoHS-Compliant fulfill the definitions and restrictions defined under Directive 2011/65/EU of The European Parliament and of the Council of June 8, 2011 on the restriction of the use of certain hazardous substances in electrical and electronic equipment (EEE) - recast, unless otherwise specified as non-compliant.

Please note that some Vishay documentation may still make reference to RoHS Directive 2002/95/EC. We confirm that all the products identified as being compliant to Directive 2002/95/EC conform to Directive 2011/65/EU.

Vishay Intertechnology, Inc. hereby certifies that all its products that are identified as Halogen-Free follow Halogen-Free requirements as per JEDEC JS709A standards. Please note that some Vishay documentation may still make reference to the IEC 61249-2-21 definition. We confirm that all the products identified as being compliant to IEC 61249-2-21 conform to JEDEC JS709A standards.

Компания «Life Electronics» занимается поставками электронных компонентов импортного и отечественного производства от производителей и со складов крупных дистрибьюторов Европы, Америки и Азии.

С конца 2013 года компания активно расширяет линейку поставок компонентов по направлению коаксиальный кабель, кварцевые генераторы и конденсаторы (керамические, пленочные, электролитические), за счёт заключения дистрибьюторских договоров

Мы предлагаем:

- Конкурентоспособные цены и скидки постоянным клиентам.
- Специальные условия для постоянных клиентов.
- Подбор аналогов.
- Поставку компонентов в любых объемах, удовлетворяющих вашим потребностям.
- Приемлемые сроки поставки, возможна ускоренная поставка.
- Доставку товара в любую точку России и стран СНГ.
- Комплексную поставку.
- Работу по проектам и поставку образцов.
- Формирование склада под заказчика.
- Сертификаты соответствия на поставляемую продукцию (по желанию клиента).
- Тестирование поставляемой продукции.
- Поставку компонентов, требующих военную и космическую приемку.
- Входной контроль качества.
- Наличие сертификата ISO.

В составе нашей компании организован Конструкторский отдел, призванный помогать разработчикам, и инженерам.

Конструкторский отдел помогает осуществить:

- Регистрацию проекта у производителя компонентов.
- Техническую поддержку проекта.
- Защиту от снятия компонента с производства.
- Оценку стоимости проекта по компонентам.
- Изготовление тестовой платы монтаж и пусконаладочные работы.



Тел: +7 (812) 336 43 04 (многоканальный)

Email: org@lifeelectronics.ru