

## SERIES: CP50 | DESCRIPTION: PELTIER MODULE

### FEATURES

- arcTEC™ structure on select models
- solid state device
- precise temperature control
- quiet operation



MODEL	input voltage <sup>1</sup> max (Vdc)	input current <sup>2</sup> max (A)	internal resistance <sup>3</sup> typ ( $\Omega \pm 10\%$ )	output Qmax <sup>4</sup>		output $\Delta T_{max}$ <sup>5</sup>	
				T <sub>h</sub> =27°C (W)	T <sub>h</sub> =50°C (W)	T <sub>h</sub> =27°C (°C)	T <sub>h</sub> =50°C (°C)
CP50141	2.1	5.0	0.31	5.5	6.1	68	75
CP50241	3.8	5.0	0.56	10.0	11.1	68	75
CP50301541	4.2	5.0	0.63	11	12.3	68	75
CP5030395 <sup>6</sup>	11.8	5.0	1.74	35.0	38.0	70	77
CP50341 <sup>6</sup>	8.6	5.0	1.29	23.0	25.7	70	77
CP50441 <sup>6</sup>	15.4	5.0	2.3	41.0	45.8	70	77

Notes:

1. Maximum voltage at  $\Delta T_{max}$  and T<sub>h</sub>=27°C
2. Maximum current to achieve  $\Delta T_{max}$
3. Measured by AC 4-terminal method at 25°C
4. Maximum heat absorbed at cold side occurs at I<sub>max'</sub>, V<sub>max'</sub>, and  $\Delta T=0^\circ\text{C}$
5. Maximum temperature difference occurs at I<sub>max'</sub>, V<sub>max'</sub>, and Q=0W ( $\Delta T_{max}$  measured in a vacuum at 1.3 Pa)
6. Designed with arcTEC™ structure

## SPECIFICATIONS

parameter	conditions/description	min	typ	max	units
solder melting temperature	connection between thermoelectric pairs	235			°C
assembly compression				1	MPa
RoHS	yes				

## MECHANICAL DRAWING

units: mm



	MATERIAL	PLATING
ceramic plate	96% $Al_2O_3$	
wire leads	20 AWG	tin
sealer	silicon rubber 703 RTV (between cold and hot side plates)	
joint cover	silicon rubber 703 RTV	
marking	P/N & S/N printed on cold side surface	

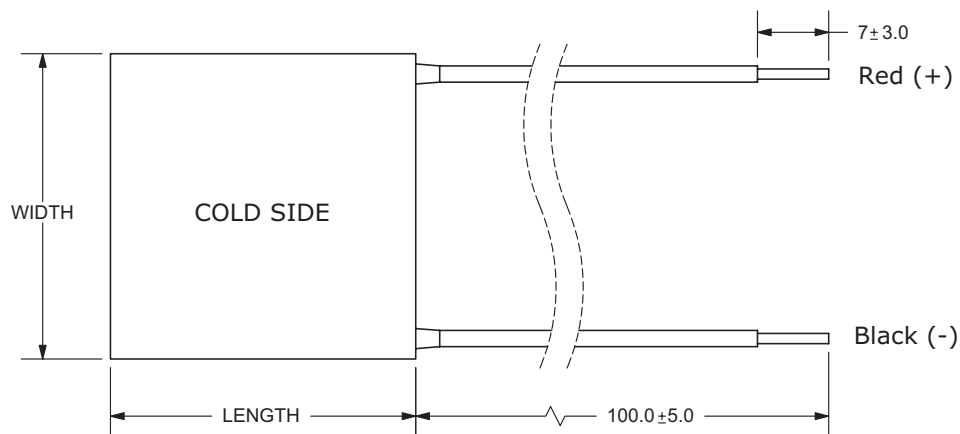

MODEL NO.	LENGTH (mm)	WIDTH (mm)	THICKNESS (mm)
CP50141	15 ± 0.3	15 ± 0.3	4.0 ± 0.1
CP50241	20 ± 0.3	20 ± 0.3	4.0 ± 0.1
CP50301541	30 ± 0.3	15 ± 0.3	4.0 ± 0.1
CP5030395	30 ± 0.3	30 ± 0.3	3.95 ± 0.025
CP50341 <sup>1</sup>	30 ± 0.3	30 ± 0.3	4.0 ± 0.1
CP50441 <sup>1</sup>	40 ± 0.3	40 ± 0.3	4.0 ± 0.1

Notes: 1. Wire lead strip length on models CP50341 & CP50441 is 10 ± 3.0 mm.

### CP50141 PERFORMANCE (Th=27°C)

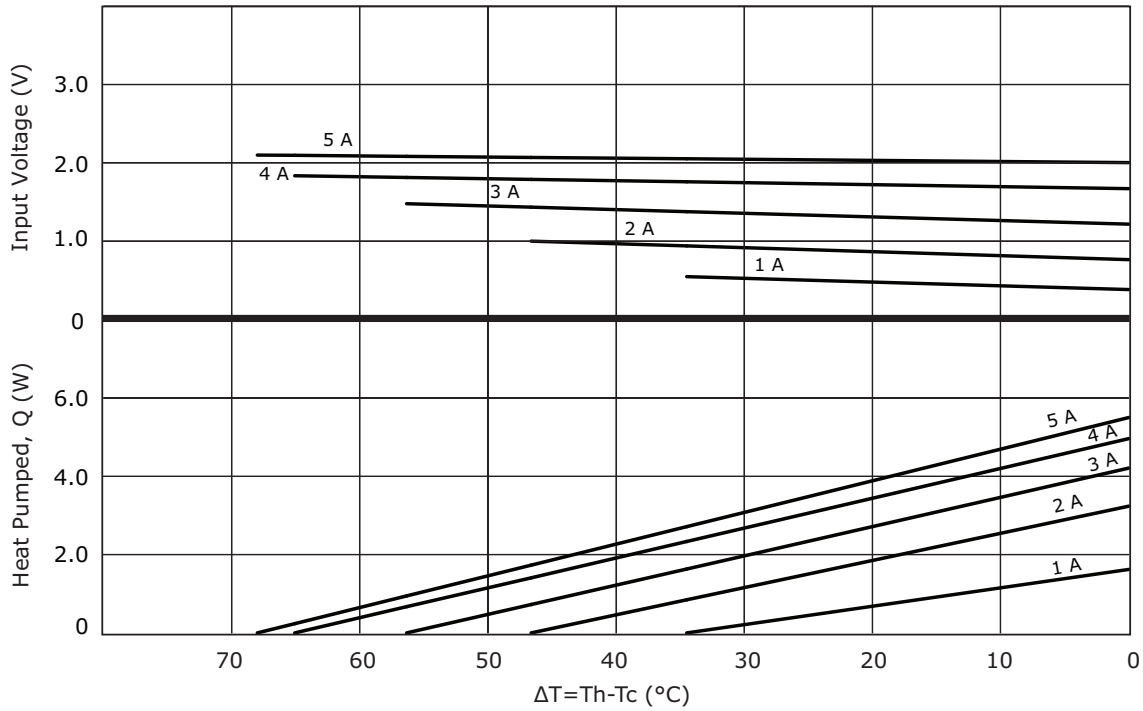

### CP50141 PERFORMANCE (Th=50°C)

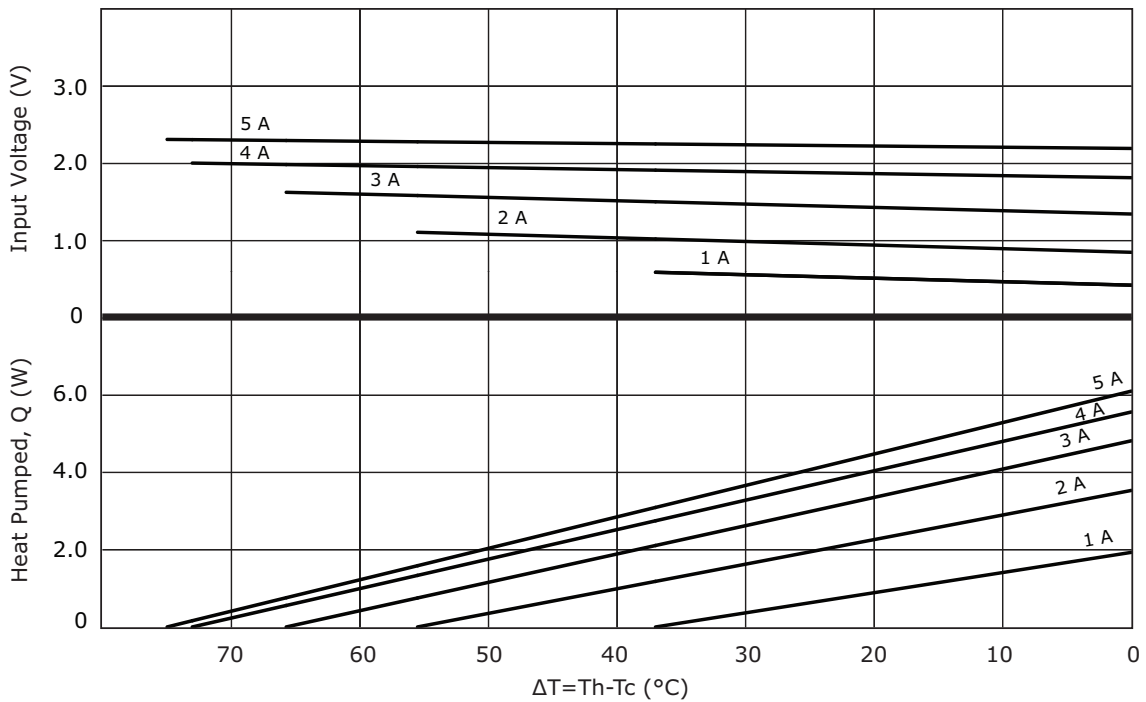

### CP50241 PERFORMANCE (Th=27°C)

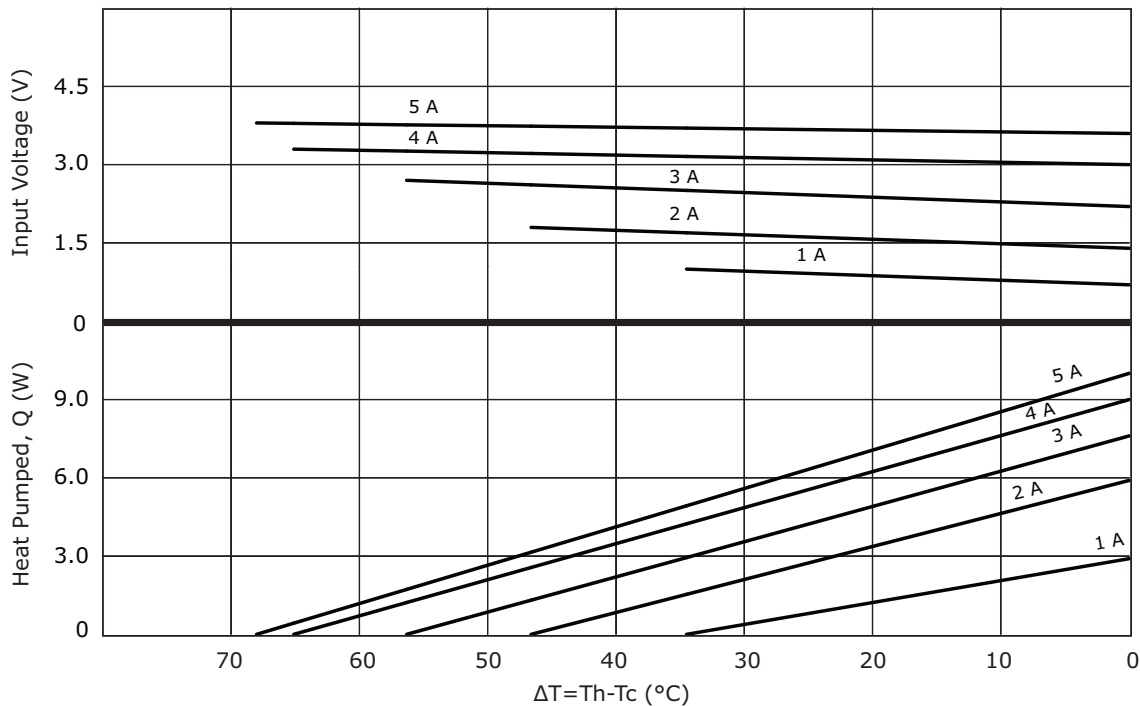

### CP50241 PERFORMANCE (Th=50°C)

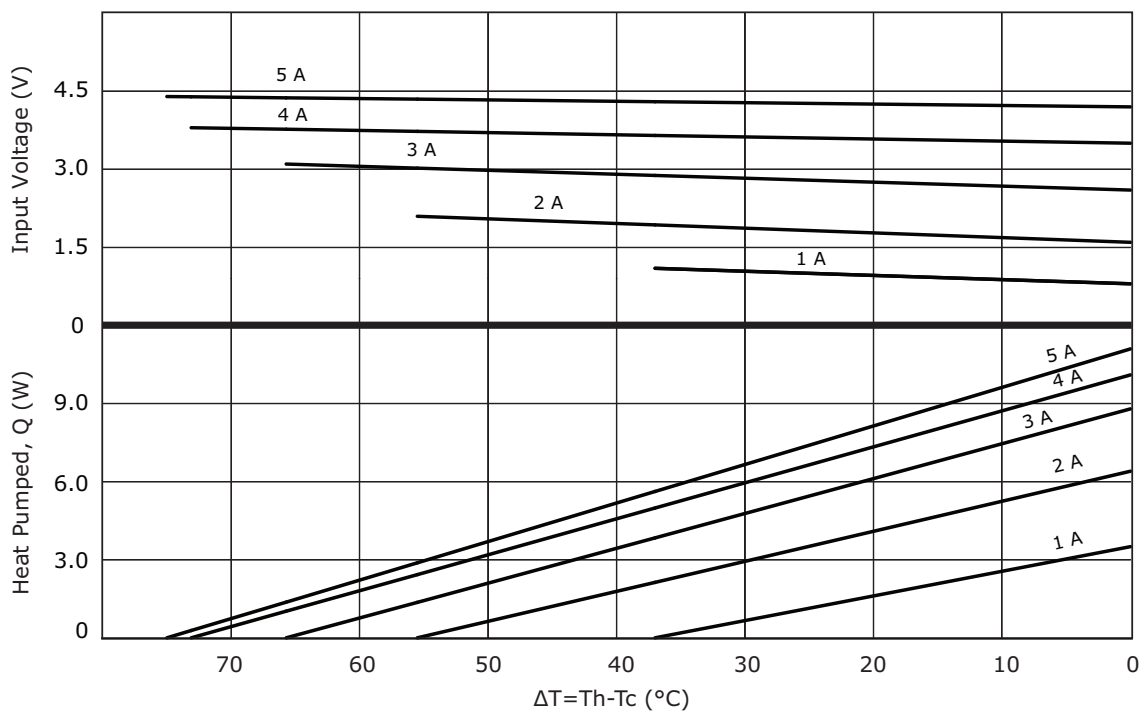

### CP50301541 PERFORMANCE (Th=27°C)



### CP50301541 PERFORMANCE (Th=50°C)



### CP5030395 PERFORMANCE (Th=27°C)

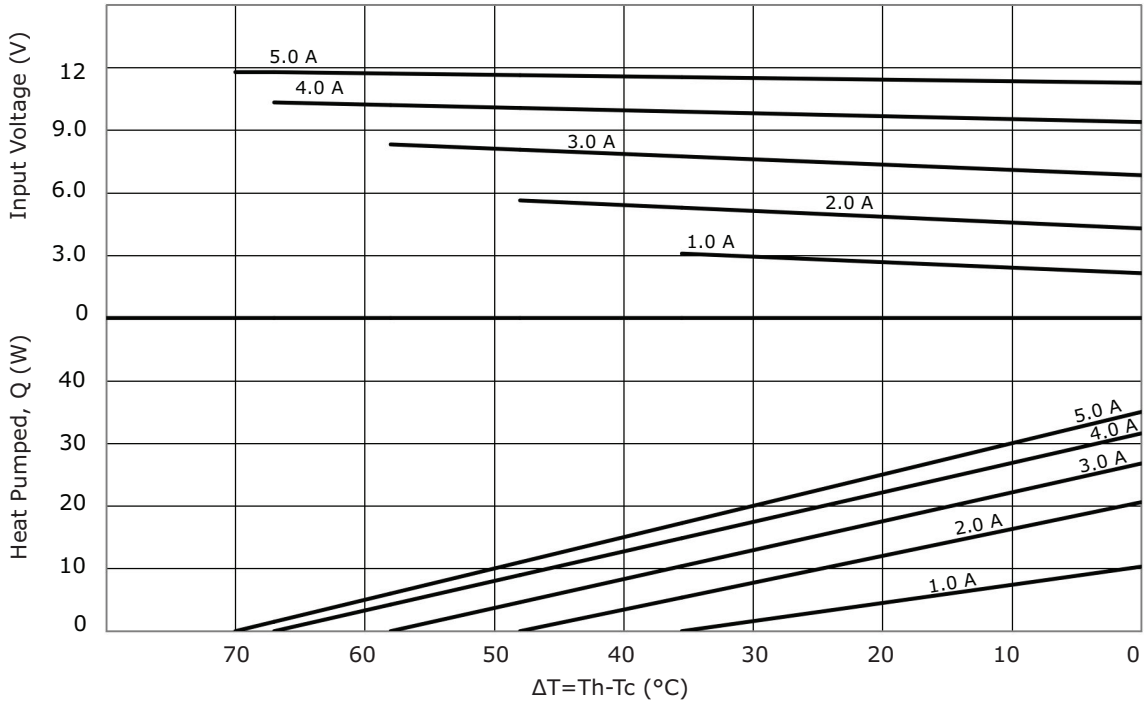

### CP5030395 PERFORMANCE (Th=50°C)



### CP50341 PERFORMANCE (Th=27°C)

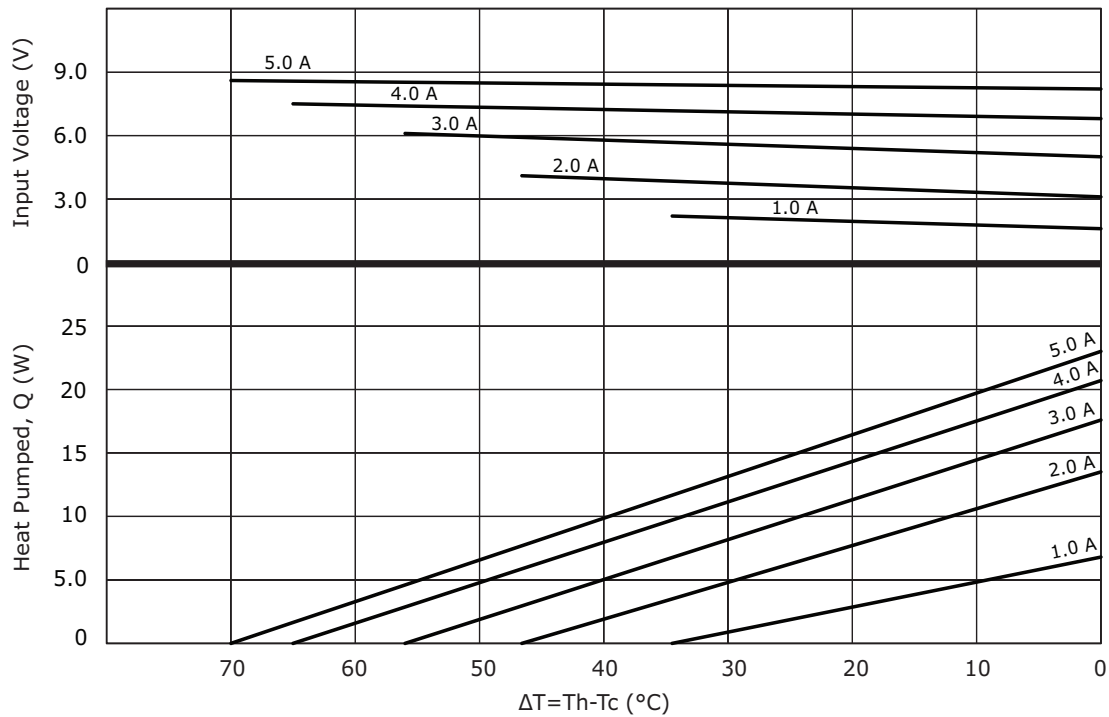

### CP50341 PERFORMANCE (Th=50°C)

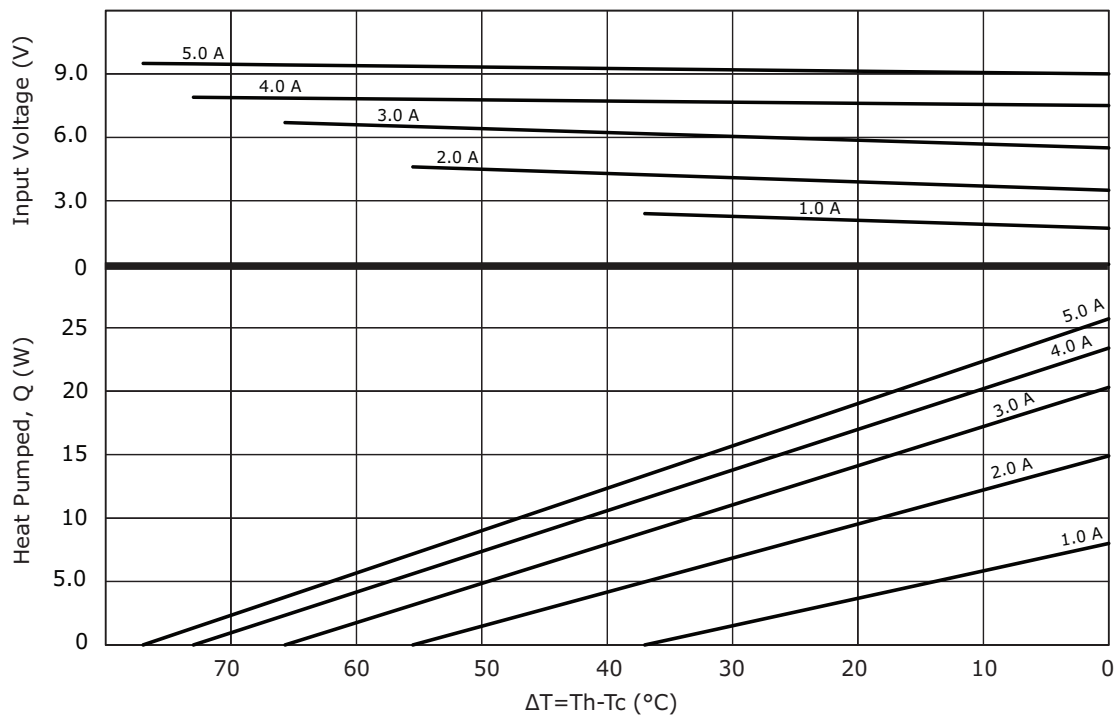

### CP50441 PERFORMANCE (Th=27°C)



### CP50441 PERFORMANCE (Th=50°C)





## REVISION HISTORY

---

rev.	description	date
1.0	initial release	09/08/2016
1.01	changed models CP50341 & CP50441 to arcTEC™ structure	12/01/2017
1.02	changed thickness of CP50141, CP50241, CP50301541 models	09/20/2018
1.03	added model CP5030395, brand update	10/18/2019

The revision history provided is for informational purposes only and is believed to be accurate.

---

# CUI DEVICES

CUI Devices offers a one (1) year limited warranty. Complete warranty information is listed on our website.

CUI Devices reserves the right to make changes to the product at any time without notice. Information provided by CUI Devices is believed to be accurate and reliable. However, no responsibility is assumed by CUI Devices for its use, nor for any infringements of patents or other rights of third parties which may result from its use.

CUI Devices products are not authorized or warranted for use as critical components in equipment that requires an extremely high level of reliability. A critical component is any component of a life support device or system whose failure to perform can be reasonably expected to cause the failure of the life support device or system, or to affect its safety or effectiveness.

Компания «Life Electronics» занимается поставками электронных компонентов импортного и отечественного производства от производителей и со складов крупных дистрибьюторов Европы, Америки и Азии.

С конца 2013 года компания активно расширяет линейку поставок компонентов по направлению коаксиальный кабель, кварцевые генераторы и конденсаторы (керамические, пленочные, электролитические), за счёт заключения дистрибьюторских договоров

Мы предлагаем:

- Конкуренеспособные цены и скидки постоянным клиентам.
- Специальные условия для постоянных клиентов.
- Подбор аналогов.
- Поставку компонентов в любых объемах, удовлетворяющих вашим потребностям.
- Приемлемые сроки поставки, возможна ускоренная поставка.
- Доставку товара в любую точку России и стран СНГ.
- Комплексную поставку.
- Работу по проектам и поставку образцов.
- Формирование склада под заказчика.
- Сертификаты соответствия на поставляемую продукцию (по желанию клиента).
- Тестирование поставляемой продукции.
- Поставку компонентов, требующих военную и космическую приемку.
- Входной контроль качества.
- Наличие сертификата ISO.

В составе нашей компании организован Конструкторский отдел, призванный помогать разработчикам, и инженерам.

Конструкторский отдел помогает осуществить:

- Регистрацию проекта у производителя компонентов.
- Техническую поддержку проекта.
- Защиту от снятия компонента с производства.
- Оценку стоимости проекта по компонентам.
- Изготовление тестовой платы монтаж и пусконаладочные работы.



Тел: +7 (812) 336 43 04 (многоканальный)

Email: [org@lifeelectronics.ru](mailto:org@lifeelectronics.ru)