

SINGLE 2 INPUT POSITIVE AND GATE WITH OPEN DRAIN OUTPUT
Description

The Advanced Ultra Low Power (AUP) CMOS logic family is designed for low power and extended battery life in portable applications.

The AUP1G09 is a single AND gate with an open drain output designed for operation over a power supply range of 0.8V to 3.6V. The device is fully specified for partial power down applications using I_{OFF}. The I_{OFF} circuitry disables the output preventing damaging current backflow when the device is powered down. The gate performs the positive Boolean function:

$$Y = \overline{A \cdot B} \text{ or } Y = \overline{A} + \overline{B}$$

Features

- Advanced Ultra Low Power (AUP) CMOS
- Supply Voltage Range from 0.8V to 3.6V
- 4mA Output Drive at 3.0V
- Low Static power consumption
 - I_{CC} < 0.9µA
- Low Dynamic Power Consumption
 - C_{PD} = 6 pF (Typical at 3.6V)
- Schmitt Trigger Action at All Inputs Make the Circuit Tolerant for Slower Input Rise and Fall Time. The hysteresis is typically 250 mV at V_{CC} = 3.0V
- I_{OFF} Supports Partial-Power-Down Mode Operation
- ESD Protection Exceeds JESD 22
 - 2000-V Human Body Model (A114-A)
 - Exceeds 1000-V Charged Device Model (C101C)
- Latch-Up Exceeds 100mA per JESD 78, Class II
- Range of Package Options SOT353, DFN1410, and DFN1010
- Leadless packages per JESD30E
 - DFN1010 denoted as X2-DFN1010-6
 - DFN1014 denoted as X2-DFN1014-6
- **Totally Lead-Free & Fully RoHS Compliant (Notes 1 & 2)**
- **Halogen and Antimony Free. "Green" Device (Note 3)**

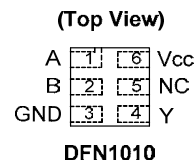
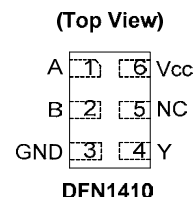
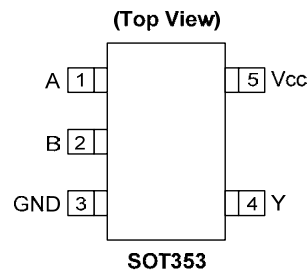
Pin Assignments

Applications

- Suited for battery and low power needs
- Wide array of products such as:
 - Tablets, E-readers
 - Cell Phones, Personal Navigation / GPS
 - MP3 players, Cameras, Video Recorders
 - PCs ultrabooks, notebooks, netbooks,
 - Computer peripherals, hard drives, CD/DVD ROM
 - TV, DVD, DVR, set top box

Notes: 1. No purposely added lead. Fully EU Directive 2002/95/EC (RoHS) & 2011/65/EU (RoHS 2) compliant.
 2. See <http://www.diodes.com> for more information about Diodes Incorporated's definitions of Halogen- and Antimony-free, "Green" and Lead-free.
 3. Halogen- and Antimony-free "Green" products are defined as those which contain <900ppm bromine, <900ppm chlorine (<1500ppm total Br + Cl) and <1000ppm antimony compounds.

[Click here for ordering information, located at the end of datasheet](#)

Pin Descriptions

Pin Name	Function
A	Data Input
B	Data Input
GND	Ground
Y	Data Output
V _{cc}	Supply Voltage

Logic Diagram

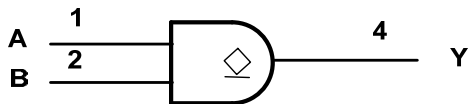

Function Table

Inputs		Output
A	B	Y
L	L	L
L	H	L
H	L	L
H	H	Z

Absolute Maximum Ratings (Note 4) (@T_A = +25°C, unless otherwise specified.)

Symbol	Parameter	Rating	Unit
ESD HBM	Human Body Model ESD Protection	2	KV
ESD CDM	Charged Device Model ESD Protection	1	KV
V _{CC}	Supply Voltage Range	-0.5 to +4.6	V
V _I	Input Voltage Range	-0.5 to +4.6	V
V _O	Voltage applied to output in high or low state	-0.5 to V _{CC} +0.5	V
I _{IK}	Input Clamp Current V _I < 0	50	mA
I _{OK}	Output Clamp Current (V _O < 0)	50	mA
I _O	Continuous Output Current (V _O = 0 to V _{CC})	±20	mA
I _{CC}	Continuous Current Through V _{CC}	50	mA
I _{GND}	Continuous Current Through GND	-50	mA
T _J	Operating Junction Temperature	-40 to +150	°C
T _{STG}	Storage Temperature	-65 to +150	°C

Note: 4. Stresses beyond the absolute maximum may result in immediate failure or reduced reliability. These are stress values and device operation should be within recommend values.

Recommended Operating Conditions (Note 5) (@T_A = +25°C, unless otherwise specified.)

Symbol	Parameter	Min	Max	Unit
V _{CC}	Operating Voltage	0.8	3.6	V
V _I	Input Voltage	0	3.6	V
V _O	Output Voltage	0	V _{CC}	V
I _{OL}	Low-Level Output Current	V _{CC} = 0.8V	20	μA
		V _{CC} = 1.1V	1.1	mA
		V _{CC} = 1.4V	1.7	
		V _{CC} = 1.65V	1.9	
		V _{CC} = 2.3V	3.1	
		V _{CC} = 3.0V	4	
Δt/ΔV	Input Transition Rise or Fall Rate	V _{CC} = 0.8V to 3.6V	200	ns/V
T _A	Operating Free-Air Temperature	-40	125	°C

Note: 5. Unused inputs should be held at V_{CC} or Ground.

Electrical Characteristics (@T_A = +25°C, unless otherwise specified.)

Symbol	Parameter	Test Conditions	V _{CC}	T _A = +25°C		T _A = -40°C to 85°C		Unit
				Min	Max	Min	Max	
V _{IH}	High-Level Input Voltage		0.8V to 1.65V	0.80 X V _{CC}		0.80 X V _{CC}		V
			1.65V to 1.95V	0.65 X V _{CC}		0.65 X V _{CC}		
			2.3V to 2.7V	1.6		1.6		
			3.0V to 3.6V	2.0		2.0		
V _{IL}	Low-Level input voltage		0.8V to 1.65V		0.30 X V _{CC}		0.30 X V _{CC}	V
			1.65V to 1.95V		0.35 X V _{CC}		0.35 X V _{CC}	
			2.3V to 2.7V		0.7		0.7	
			3.0V to 3.6V		0.9		0.9	
V _{OL}	High-Level Input Voltage	I _{OL} = 20μA	0.8V to 3.6V		0.1		0.1	V
		I _{OL} = 1.1mA	1.1V		0.3 X V _{CC}		0.3 X V _{CC}	
		I _{OL} = 1.7mA	1.4V		0.31		0.37	
		I _{OL} = 1.9mA	1.65V		0.31		0.35	
		I _{OL} = 2.3mA	2.3V		0.31		0.33	
		I _{OL} = 3.1mA			0.44		0.45	
		I _{OL} = 2.7mA	3V		0.31		0.33	
		I _{OL} = 4mA			0.44		0.45	
I _I	Input Current	A or B Input V _I = GND to 3.6V	0V to 3.6V		± 0.1		± 0.5	μA
I _{OFF}	Power Down Leakage Current	V _I or V _O = 0V to 3.6V	0		± 0.2		± 0.5	μA
I _{OZ}	Z State Leakage Current	V _O = 3.6V V _I = 3.6V	3.6V		± 0.2		± 0.5	μA
ΔI _{OFF}	Delta Power Down Leakage Current	V _I or V _O = 0V to 3.6V	0V to 0.2V		0.2		0.6	μA
I _{CC}	Supply Current	V _I = GND or V _{CC} I _O = 0	0.8V to 3.6V		0.5		0.9	μA
ΔI _{CC}	Additional Supply Current	Input at V _{CC} -0.6V	3.3V		40		50	μA

Electrical Characteristics (cont.) (@T_A = +25°C, unless otherwise specified.)

Symbol	Parameter	Test Conditions	V _{CC}	T _A = -40°C to +125°C		Unit
				Min	Max	
V _{IH}	High-Level Input Voltage		0.8V to 1.65V	0.80 X V _{CC}		V
			1.65V to 1.95V	0.70 X V _{CC}		
			2.3V to 2.7V	1.6		
			3.0V to 3.6V	2.0		
V _{IL}	Low-Level Input Voltage		0.8V to 1.65V		0.25X V _{CC}	V
			1.65V to 1.95V		0.35 X V _{CC}	
			2.3V to 2.7V		0.7	
			3.0V to 3.6V		0.9	
V _{OL}	High-Level Input Voltage	I _{OL} = 20 μA	0.8V to 3.6V		0.11	V
		I _{OL} = 1.1 mA	1.1V		0.3 X V _{CC}	
		I _{OL} = 1.7 mA	1.4V		0.41	
		I _{OL} = 1.9 mA	1.65V		0.39	
		I _{OL} = 2.3 mA	2.3V		0.36	
		I _{OL} = 3.1 mA			0.50	
		I _{OL} = 2.7 mA	3V		0.36	
		I _{OL} = 4 mA			0.50	
I _I	Input Current	A or B Input V _I = GND to 3.6V	0V to 3.6V		± 0.75	μA
I _{OFF}	Power Down Leakage Current	V _I or V _O = 0V to 3.6V	0		± 3.5	μA
I _{OZ}	Z State Leakage Current	V _O = 3.6V V _I = 3.6V	3.6V		± 1.5	μA
ΔI _{OFF}	Delta Power Down Leakage Current	V _I or V _O = 0V to 3.6V	0V to 0.2V		± 2.5	μA
I _{CC}	Supply Current	V _I = GND or V _{CC} , I _O = 0	0.8V to 3.6V		3.0	μA
ΔI _{CC}	Additional Supply Current	Input at V _{CC} -0.6V	3.3V		75	μA

Switching Characteristics

 $C_L=5\text{pF}$ see Figure 1

Parameter	From Input	TO OUTPUT	V _{CC}	T _A = +25°C			T _A = -40°C to +85°C		T _A = -40°C to +125°C		Unit
				Min	Typ	Max	Min	Max	Min	Max	
t _{pd}	A	Y	0.8V		13.5						ns
			1.2V ± 0.1V	1.9	4.6	10.4	1.8	11.4	1.8	12.6	
			1.5V ± 0.1V	1.5	3.3	6.5	1.4	7.4	1.4	8.2	
			1.8V ± 0.15V	1.2	2.9	5.1	1.1	5.9	1.1	6.5	
			2.5V ± 0.2V	1.0	2.4	4.4	0.9	4.6	0.9	4.9	
			3.3V ± 0.3V	0.9	2.3	4.0	0.8	4.5	0.8	4.9	

 $C_L=10\text{pF}$ see Figure 1

Parameter	From Input	TO OUTPUT	V _{CC}	T _A = +25°C			T _A = -40°C to +85°C		T _A = -40°C to +125°C		Unit
				Min	Typ	Max	Min	Max	Min	Max	
t _{pd}	A	Y	0.8V		16.3						ns
			1.2V ± 0.1V	2.3	5.6	12.3	2.1	13.7	2.1	15.1	
			1.5V ± 0.1V	1.8	4.1	7.6	1.7	8.8	1.7	9.7	
			1.8V ± 0.15V	1.6	3.2	7.3	1.4	7.1	1.4	7.0	
			2.5V ± 0.2V	1.4	2.9	6.1	1.2	6.4	1.2	5.9	
			3.3V ± 0.3V	1.3	2.9	5.7	1.1	5.4	1.1	5.9	

 $C_L=15\text{pF}$ see Figure 1

Parameter	From Input	TO OUTPUT	V _{CC}	T _A = +25°C			T _A = -40°C to +85°C		T _A = -40°C to +125°C		Unit
				Min	Typ	Max	Min	Max	Min	Max	
t _{pd}	A	Y	0.8V		19.0						ns
			1.2V ± 0.1V	2.6	7.6	14.2	2.4	15.8	2.4	17.4	
			1.5V ± 0.1V	2.1	6.5	12.1	1.9	12.7	1.9	12.9	
			1.8V ± 0.15V	1.9	5.5	9.6	1.7	10.1	1.7	10.3	
			2.5V ± 0.2V	1.6	4.6	8.1	1.5	9.1	1.5	9.3	
			3.3V ± 0.3V	1.6	4.1	7.5	1.4	8.3	1.4	9.1	

 $C_L=30\text{pF}$ see Figure 1

Parameter	From Input	TO OUTPUT	V _{CC}	T _A = +25°C			T _A = -40°C to +85°C		T _A = -40°C to +125°C		Unit
				Min	Typ	Max	Min	Max	Min	Max	
t _{pd}	A	Y	0.8V		27						ns
			1.2V ± 0.1V	3.6	9.5	19.5	3.2	21.8	3.2	24	
			1.5V ± 0.1V	2.9	8.5	16.1	2.6	13.6	2.6	15	
			1.8V ± 0.15V	2.6	7.7	15.2	2.3	13.3	2.3	14.6	
			2.5V ± 0.2V	2.4	7	13.1	2.1	13.3	2.1	13.5	
			3.3V ± 0.3V	2.3	6.5	12.7	2.1	12.9	2.1	12.9	

Operating and Package Characteristics (@T_A = +25°C, unless otherwise specified.)

Parameter	Test Conditions	V _{CC}	Typ	Unit	
C _{pd}	Power Dissipation Capacitance	f = 1MHz No Load	0.8V	2.6	pF
			1.2V ± 0.1V	2.8	
			1.5V ± 0.1V	2.9	
			1.8V ± 0.15V	3.1	
			2.5V ± 0.2V	3.6	
			3.3V ± 0.3V	4.2	
C _i	Input Capacitance	V _i = V _{CC} or GND	0V or 3.3V	1.5	pF
θ _{JA}	Thermal Resistance Junction-to-Ambient	SOT353	(Note 6)	371	°C/W
		X2-DFN1410-6		430	
		X2-DFN1010-6		445	
θ _{JC}	Thermal Resistance Junction-to-Case	SOT353	(Note 6)	143	°C/W
		X2-DFN1410-6		190	
		X2-DFN1010-6		250	

Notes: 6. Test condition for SOT353, X2-DFN1410-6, and X2-DFN1010-6 devices mounted on FR-4 substrate PC board, 2oz copper, with minimum recommended pad layout.

Parameter Measurement Information

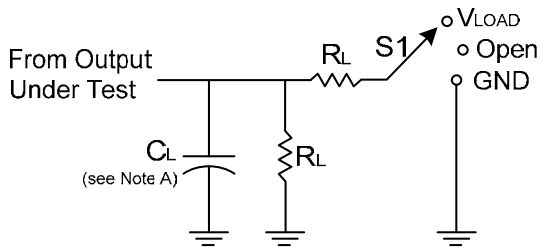

TEST	S1	R _L
t _{PLZ} /t _{PZL}	V _{load}	5KΩ

V _{CC}	Inputs		V _M	V _{LOAD}	C _L	V _Δ
	V _i	t _r /t _f				
0.8V	V _{CC}	≤3ns	V _{CC} /2	2 X V _{CC}	5, 10, 15, 30pF	0.1V
1.2V±0.1V	V _{CC}	≤3ns	V _{CC} /2	2 X V _{CC}	5, 10, 15, 30pF	0.1V
1.5V±0.1V	V _{CC}	≤3ns	V _{CC} /2	2 X V _{CC}	5, 10, 15, 30pF	0.1V
1.8V±0.15V	V _{CC}	≤3ns	V _{CC} /2	2 X V _{CC}	5, 10, 15, 30pF	0.15V
2.5V±0.2V	V _{CC}	≤3ns	V _{CC} /2	2 X V _{CC}	5, 10, 15, 30pF	0.15V
3.3V±0.3 V	V _{CC}	≤3ns	V _{CC} /2	2 X V _{CC}	5, 10, 15, 30pF	0.3V

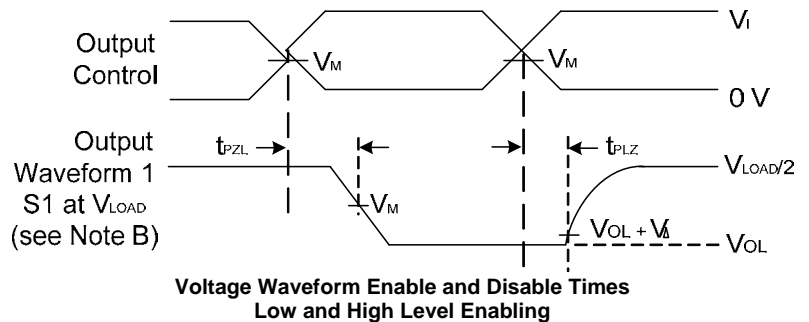
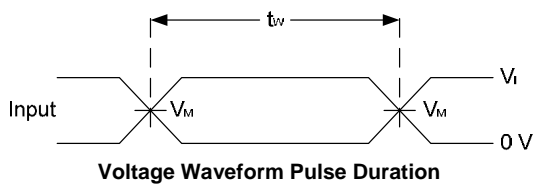
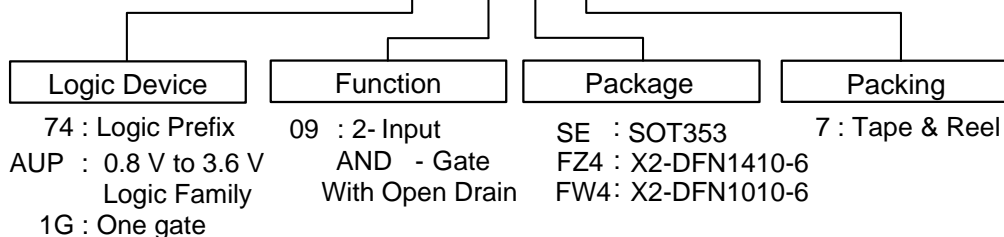

Figure 1. Load Circuit and Voltage Waveforms

- Notes:
- A. Includes test lead and test apparatus capacitance.
 - B. All pulses are supplied at pulse repetition rate ≤ 10 MHz.
 - C. Inputs are measured separately one transition per measurement.
 - D. For the open drain device the specified propagation delay t_{PD} is the same as t_{PLZ} and t_{PZL}.

Ordering Information

74AUP1G 09 XX - 7



Part Number	Package Code	Packaging	7" Tape and Reel	
			Quantity	Part Number Suffix
74AUP1G09SE-7	SE	SOT353	3000/Tape & Reel	-7
74AUP1G09FZ4-7	FZ4	X2-DFN1410-6	5000/Tape & Reel	-7
74AUP1G09FW4-7	FW4	X2-DFN1010-6	5000/Tape & Reel	-7

Marking Information

(1) SOT353

(Top View)

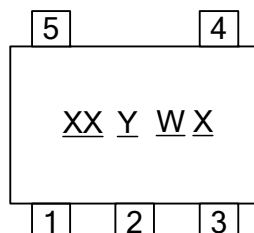

XX : Identification code
Y : Year 0~9
W : Week : A~Z : 1~26 week;
a~z : 27~52 week; z represents
52 and 53 week
X : A~Z : Internal code

Part Number	Package	Identification Code
74AUP1G09SE	SOT353	XR

(2) X2-DFN1410-6 and X2-DFN1010-6

(Top View)

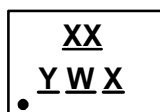

XX : Identification Code
Y : Year : 0~9
W : Week : A~Z : 1~26 week;
a~z : 27~52 week; z represents
52 and 53 week
X : A~Z : Internal code

Part Number	Package	Identification Code
74AUP1G09FZ4	X2-DFN1410-6	XR
74AUP1G09FW4	X2-DFN1010-6	XR

Package Outline Dimensions (All dimensions in mm.)

Please see AP02002 at <http://www.diodes.com/datasheets/ap02002.pdf> for latest version.

(1) SOT353



SOT353			
Dim	Min	Max	Typ
A	0.10	0.30	0.25
B	1.15	1.35	1.30
C	2.00	2.20	2.10
D	0.65 Typ		
F	0.40	0.45	0.425
H	1.80	2.20	2.15
J	0	0.10	0.05
K	0.90	1.00	1.00
L	0.25	0.40	0.30
M	0.10	0.22	0.11
α	0°	8°	-
All Dimensions in mm			

(2) X2-DFN1410-6

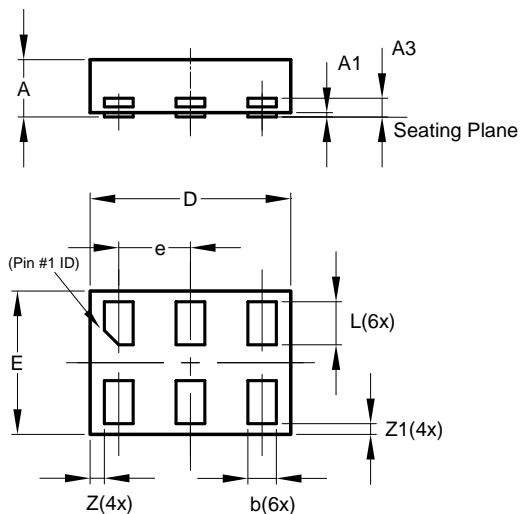

X2-DFN1410-6			
Dim	Min	Max	Typ
A	—	0.40	0.39
A1	0.00	0.05	0.02
A3	—	—	0.13
b	0.15	0.25	0.20
D	1.35	1.45	1.40
E	0.95	1.05	1.00
e	—	—	0.50
L	0.25	0.35	0.30
Z	—	—	0.10
Z1	0.045	0.105	0.075
All Dimensions in mm			

Package Outline Dimensions (cont.) (All dimensions in mm.)

Please see AP02002 at <http://www.diodes.com/datasheets/ap02002.pdf> for latest version.

(3) X2-DFN1010-6

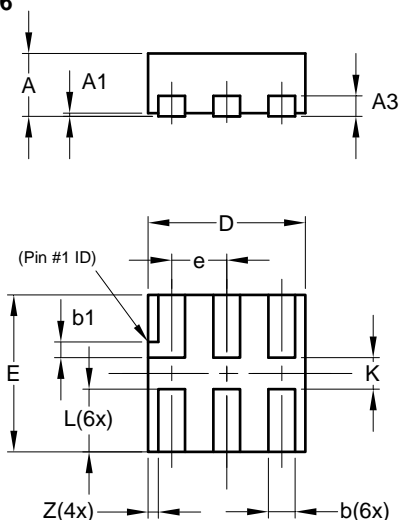

X2-DFN1010-6			
Dim	Min	Max	Typ
A	—	0.40	0.39
A1	0.00	0.05	0.02
A3	—	—	0.13
b	0.14	0.20	0.17
b1	0.05	0.15	0.10
D	0.95	1.05	1.00
E	0.95	1.05	1.00
e	—	—	0.35
L	0.35	0.45	0.40
K	0.15	—	—
Z	—	—	0.065
All Dimensions in mm			

Suggested Pad Layout

Please see AP02001 at <http://www.diodes.com/datasheets/ap02001.pdf> for the latest version

(1) SOT353

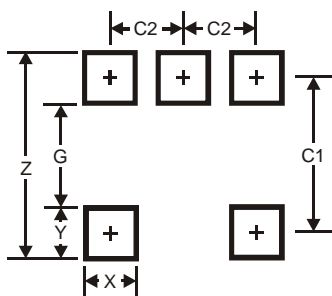

Dimensions	Value (in mm)
Z	2.5
G	1.3
X	0.42
Y	0.6
C1	1.9
C2	0.65

(2) X2-DFN1410-6



Dimensions	Value (in mm)
C	0.500
G	0.250
X	0.250
X1	1.250
Y	0.525
Y1	1.250

Suggested Pad Layout (cont.)

Please see AP02001 at <http://www.diodes.com/datasheets/ap02001.pdf> for the latest version.

(3) X2-DFN1010-6

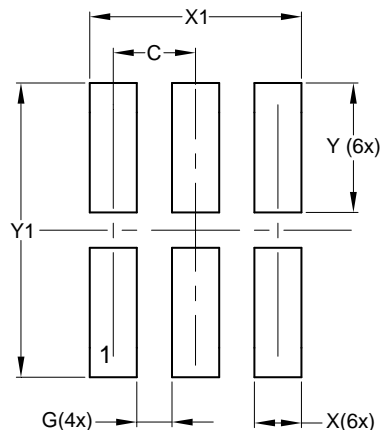

Dimensions	Value (in mm)
C	0.350
G	0.150
X	0.200
X1	0.900
Y	0.550
Y1	1.250

IMPORTANT NOTICE

DIODES INCORPORATED MAKES NO WARRANTY OF ANY KIND, EXPRESS OR IMPLIED, WITH REGARDS TO THIS DOCUMENT, INCLUDING, BUT NOT LIMITED TO, THE IMPLIED WARRANTIES OF MERCHANTABILITY AND FITNESS FOR A PARTICULAR PURPOSE (AND THEIR EQUIVALENTS UNDER THE LAWS OF ANY JURISDICTION).

Diodes Incorporated and its subsidiaries reserve the right to make modifications, enhancements, improvements, corrections or other changes without further notice to this document and any product described herein. Diodes Incorporated does not assume any liability arising out of the application or use of this document or any product described herein; neither does Diodes Incorporated convey any license under its patent or trademark rights, nor the rights of others. Any Customer or user of this document or products described herein in such applications shall assume all risks of such use and will agree to hold Diodes Incorporated and all the companies whose products are represented on Diodes Incorporated website, harmless against all damages.

Diodes Incorporated does not warrant or accept any liability whatsoever in respect of any products purchased through unauthorized sales channel. Should Customers purchase or use Diodes Incorporated products for any unintended or unauthorized application, Customers shall indemnify and hold Diodes Incorporated and its representatives harmless against all claims, damages, expenses, and attorney fees arising out of, directly or indirectly, any claim of personal injury or death associated with such unintended or unauthorized application.

Products described herein may be covered by one or more United States, international or foreign patents pending. Product names and markings noted herein may also be covered by one or more United States, international or foreign trademarks.

LIFE SUPPORT

Diodes Incorporated products are specifically not authorized for use as critical components in life support devices or systems without the express written approval of the Chief Executive Officer of Diodes Incorporated. As used herein:

- A. Life support devices or systems are devices or systems which:
 - 1. are intended to implant into the body, or
 - 2. support or sustain life and whose failure to perform when properly used in accordance with instructions for use provided in the labeling can be reasonably expected to result in significant injury to the user.
- B. A critical component is any component in a life support device or system whose failure to perform can be reasonably expected to cause the failure of the life support device or to affect its safety or effectiveness.

Customers represent that they have all necessary expertise in the safety and regulatory ramifications of their life support devices or systems, and acknowledge and agree that they are solely responsible for all legal, regulatory and safety-related requirements concerning their products and any use of Diodes Incorporated products in such safety-critical, life support devices or systems, notwithstanding any devices- or systems-related information or support that may be provided by Diodes Incorporated. Further, Customers must fully indemnify Diodes Incorporated and its representatives against any damages arising out of the use of Diodes Incorporated products in such safety-critical, life support devices or systems.

Copyright © 2012, Diodes Incorporated

www.diodes.com

Компания «Life Electronics» занимается поставками электронных компонентов импортного и отечественного производства от производителей и со складов крупных дистрибьюторов Европы, Америки и Азии.

С конца 2013 года компания активно расширяет линейку поставок компонентов по направлению коаксиальный кабель, кварцевые генераторы и конденсаторы (керамические, пленочные, электролитические), за счёт заключения дистрибьюторских договоров

Мы предлагаем:

- Конкурентоспособные цены и скидки постоянным клиентам.
- Специальные условия для постоянных клиентов.
- Подбор аналогов.
- Поставку компонентов в любых объемах, удовлетворяющих вашим потребностям.
- Приемлемые сроки поставки, возможна ускоренная поставка.
- Доставку товара в любую точку России и стран СНГ.
- Комплексную поставку.
- Работу по проектам и поставку образцов.
- Формирование склада под заказчика.
- Сертификаты соответствия на поставляемую продукцию (по желанию клиента).
- Тестирование поставляемой продукции.
- Поставку компонентов, требующих военную и космическую приемку.
- Входной контроль качества.
- Наличие сертификата ISO.

В составе нашей компании организован Конструкторский отдел, призванный помогать разработчикам, и инженерам.

Конструкторский отдел помогает осуществить:

- Регистрацию проекта у производителя компонентов.
- Техническую поддержку проекта.
- Защиту от снятия компонента с производства.
- Оценку стоимости проекта по компонентам.
- Изготовление тестовой платы монтаж и пусконаладочные работы.



Тел: +7 (812) 336 43 04 (многоканальный)

Email: org@lifeelectronics.ru