

ZXMN3A04K

30V N-CANNEL ENHANCEMENT MODE MOSFET IN DPAK

SUMMARY

$V_{(BR)DSS}=30V$: $R_{DS(on)}=0.02\Omega$; $I_D=18.4A$

DESCRIPTION

This new generation of Trench MOSFETs from Zetex utilizes a unique structure that combines the benefits of low on-resistance with fast switching speed. This makes them ideal for high efficiency, low voltage power management applications.

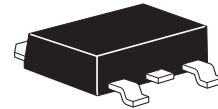

DPAK

FEATURES

- Low on-resistance
- Fast switching speed
- Low threshold
- Low gate drive
- DPAK (TO252) package

APPLICATIONS

- DC-DC converters
- Power management functions
- Disconnect switches
- Motor control

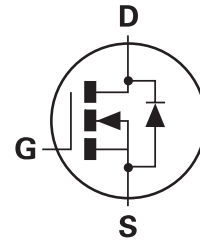

ORDERING INFORMATION

DEVICE	REEL SIZE	TAPE WIDTH	QUANTITY PER REEL
ZXMN3A04KTC	13"	16mm	2500 units

DEVICE MARKING

- ZXMN
3A04K

PINOUT

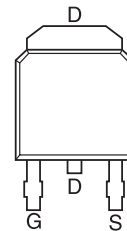

TOP VIEW

ZXMN3A04K

ABSOLUTE MAXIMUM RATINGS

PARAMETER	SYMBOL	LIMIT	UNIT
Drain-source voltage	V_{DSS}	30	V
Gate-source voltage	V_{GS}	± 20	V
Continuous drain current @ $V_{GS}=10V$; $T_A=25^\circ C$ ^(b)	I_D	18.4	A
@ $V_{GS}=10V$; $T_A=70^\circ C$ ^(b)		14.7	A
@ $V_{GS}=10V$; $T_A=25^\circ C$ ^(a)		12.0	A
Pulsed drain current ^(c)	I_{DM}	66	A
Continuous source current (body diode) ^(b)	I_S	11.5	A
Pulsed source current (body diode) ^(c)	I_{SM}	66	A
Power dissipation at $T_A = 25^\circ C$ ^(a)	P_D	4.3	W
Linear derating factor		34.4	mW/ $^\circ C$
Power dissipation at $T_A = 25^\circ C$ ^(b)	P_D	10.1	W
Linear derating factor		80.8	mW/ $^\circ C$
Power dissipation at $T_A = 25^\circ C$ ^(d)	P_D	2.15	W
Linear derating factor		17.2	mW/ $^\circ C$
Operating and storage temperature range	T_j, T_{stg}	-55 to +150	$^\circ C$

THERMAL RESISTANCE

PARAMETER	SYMBOL	VALUE	UNIT
Junction to ambient ^(a)	$R_{\theta JA}$	29	$^\circ C/W$
Junction to ambient ^(b)	$R_{\theta JA}$	12.3	$^\circ C/W$
Junction to ambient ^(d)	$R_{\theta JA}$	58	$^\circ C/W$

NOTES

- (a) For a device surface mounted on 50mm x 50mm x 1.6mm FR4 PCB with high coverage of single sided 2oz copper, in still air conditions.
 (b) For a device surface mounted on FR4 PCB measured at ≤ 10 sec.
 (c) Repetitive rating 50mm x 50mm x 1.6mm FR4 PCB, D=0.02 pulse width=300 μs - pulse width limited by maximum junction temperature.
 (d) For a device surface mounted on 50mm x 50mm x 1.6mm FR4 PCB with high coverage of single sided 1oz copper, in still air conditions.

ZXMN3A04K

TYPICAL CHARACTERISTICS

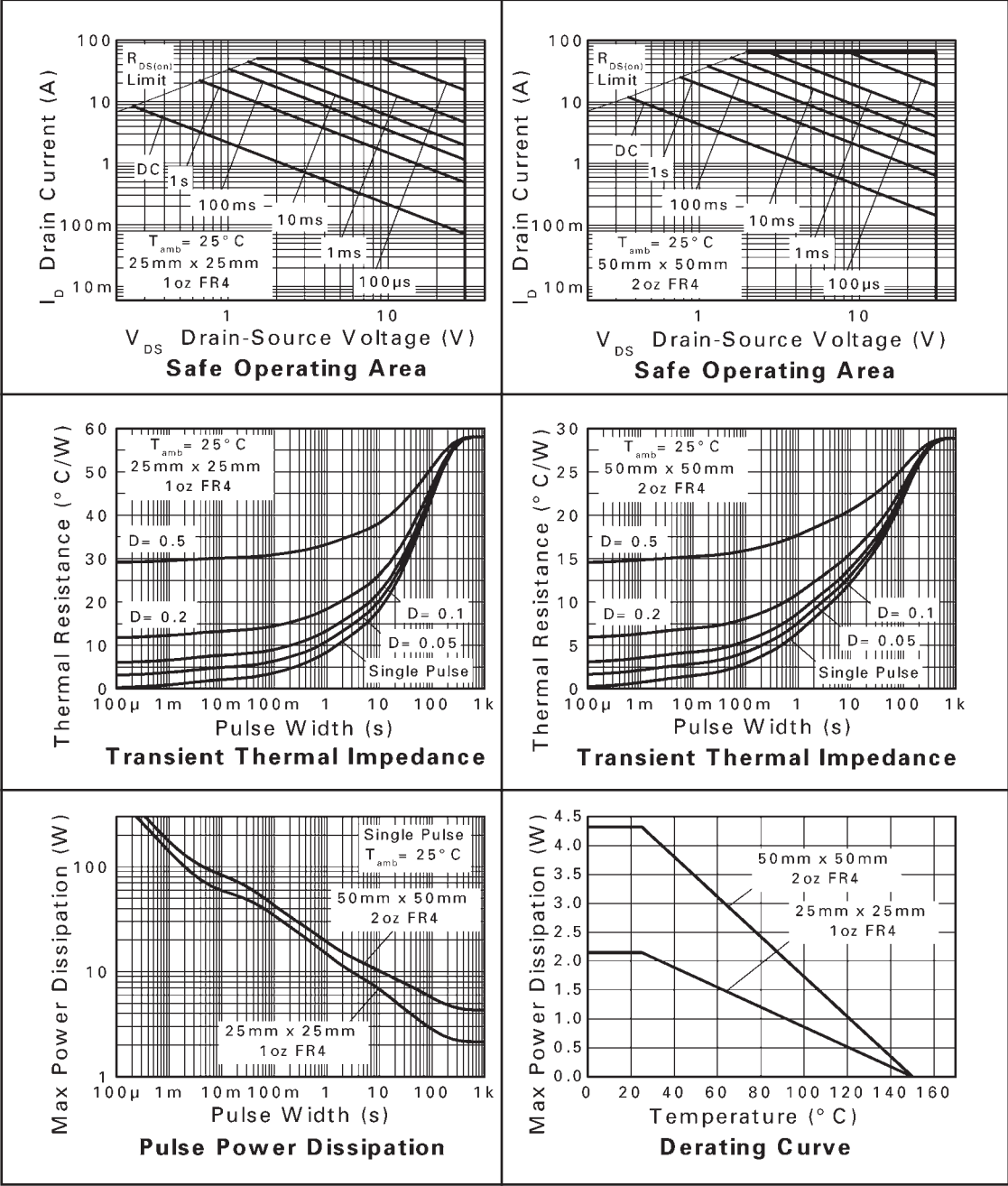

ZXMN3A04K

ELECTRICAL CHARACTERISTICS (at $T_{amb} = 25^{\circ}\text{C}$ unless otherwise stated)

PARAMETER	SYMBOL	MIN.	TYP.	MAX.	UNIT	CONDITIONS
STATIC						
Drain-source breakdown voltage	$V_{(BR)DSS}$	30			V	$I_D = 250\mu\text{A}$, $V_{GS} = 0\text{V}$
Zero gate voltage drain current	I_{DSS}			0.5	μA	$V_{DS} = 30\text{V}$, $V_{GS} = 0\text{V}$
Gate-body leakage	I_{GSS}			100	nA	$V_{GS} = \pm 20\text{V}$, $V_{DS} = 0\text{V}$
Gate-source threshold voltage	$V_{GS(th)}$	1.0			V	$I_D = 250\text{mA}$, $V_{DS} = V_{GS}$
Static drain-source on-state resistance ⁽¹⁾	$R_{DS(on)}$			0.02	Ω	$V_{GS} = 10\text{V}$, $I_D = 12\text{A}$
				0.03	Ω	$V_{GS} = 4.5\text{V}$, $I_D = 9.8\text{A}$
Forward transconductance ⁽¹⁾ ⁽³⁾	g_{fs}		22.1		S	$V_{DS} = 15\text{V}$, $I_D = 12.6\text{A}$
DYNAMIC ⁽³⁾						
Input capacitance	C_{iss}		1890		pF	$V_{DS} = 15\text{V}$, $V_{GS} = 0\text{V}$ $f = 1\text{MHz}$
Output capacitance	C_{oss}		349		pF	
Reverse transfer capacitance	C_{rss}		218		pF	
SWITCHING ⁽²⁾ ⁽³⁾						
Turn-on-delay time	$t_{d(on)}$		5.2		ns	$V_{DD} = 15\text{V}$, $I_D = 1\text{A}$ $R_G = 6.0\Omega$, $V_{GS} = 10\text{V}$
Rise time	t_r		6.1		ns	
Turn-off delay time	$t_{d(off)}$		38.1		ns	
Fall time	t_f		20.2		ns	
Total gate charge	Q_g		19.9		nC	$V_{DS} = 15\text{V}$, $V_{GS} = 5\text{V}$ $I_D = 6.5\text{A}$
Total gate charge	Q_g		36.8		nC	$V_{DS} = 15\text{V}$, $V_{GS} = 10\text{V}$ $I_D = 6.5\text{A}$
Gate-source charge	Q_{gs}		5.8		nC	
Gate drain charge	Q_{gd}		7.1		nC	
SOURCE-DRAIN DIODE						
Diode forward voltage (1)	V_{SD}		0.85	0.95	V	$T_J = 25^{\circ}\text{C}$, $I_S = 6.8\text{A}$, $V_{GS} = 0\text{V}$
Reverse recovery time (3)	t_{rr}		18.4		ns	$T_J = 25^{\circ}\text{C}$, $I_S = 2.3\text{A}$,
Reverse recovery charge (3)	Q_{rr}		11		nC	$di/dt = 100\text{A}/\mu\text{s}$

NOTES

(1) Measured under pulsed conditions. Pulse width $\leq 300\mu\text{s}$; duty cycle $\leq 2\%$.

(2) Switching characteristics are independent of operating junction temperature.

(3) For design aid only, not subject to production testing.

ZXMN3A04K

TYPICAL CHARACTERISTICS

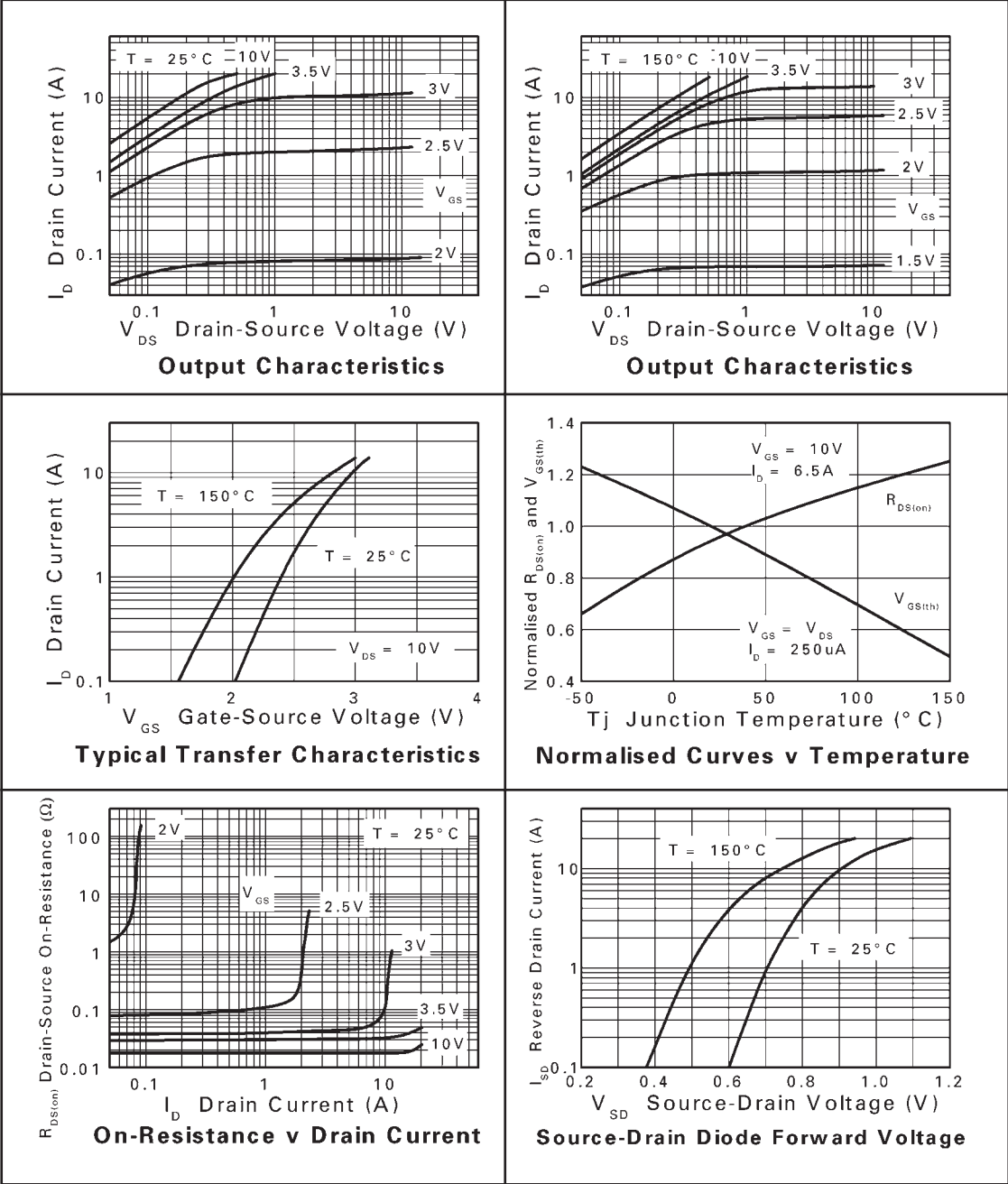

ZXMN3A04K

TYPICAL CHARACTERISTICS

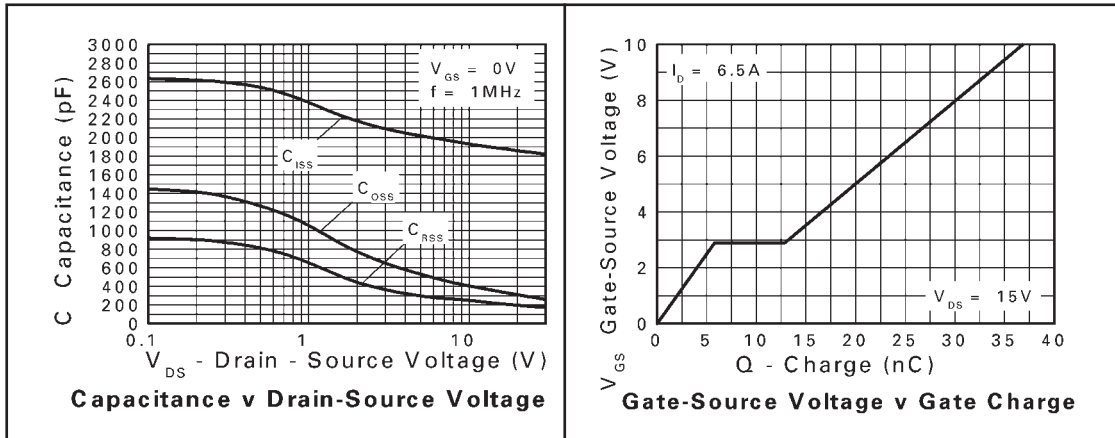

ZXMN3A04K

PACKAGE OUTLINE

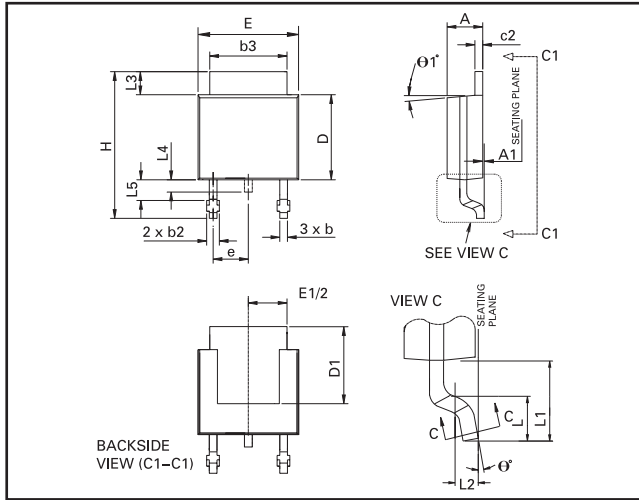

Controlling dimensions are in millimeters. Approximate conversions are given in inches

PACKAGE DIMENSIONS

DIM	Millimeters		Inches		DIM	Millimeters		Inches	
	Min	Max	Min	Max		Min	Max	Min	Max
A	2.18	2.38	0.086	0.094	e	2.30 BSC		0.090 BSC	
A1	—	0.127	—	0.005	H	9.40	10.41	0.370	0.410
b	0.635	0.89	0.025	0.035	L	1.40	1.78	0.055	0.070
b2	0.762	1.114	0.030	0.045	L1	2.74 REF		0.108 REF	
b3	5.20	5.46	0.205	0.215	L2	0.051 BSC		0.020 BSC	
c	0.457	0.609	0.018	0.024	L3	0.89	1.27	0.035	0.050
c2	0.457	0.584	0.018	0.023	L4	0.635	1.01	0.025	0.040
D	5.97	6.22	0.235	0.245	L5	1.14	1.52	0.045	0.060
D1	5.20	—	0.205	—	θ1°	0°	10°	0°	10°
E	6.35	6.73	0.250	0.265	θ°	0°	15°	0°	15°
E1	4.32	—	0.170	—	—	—	—	—	—

© Zetex plc 2004

Europe	Americas	Asia Pacific	Corporate Headquarters
Zetex GmbH Streitfeldstraße 19 D-81673 München Germany	Zetex Inc 700 Veterans Memorial Hwy Hauppauge, NY 11788 USA	Zetex (Asia) Ltd 3701-04 Metroplaza Tower 1 Hing Fong Road, Kwai Fong Hong Kong	Zetex plc Fields New Road, Chadderton Oldham, OL9 8NP United Kingdom
Telephone: (49) 89 45 49 49 0 Fax: (49) 89 45 49 49 49 europe.sales@zetex.com	Telephone: (1) 631 360 2222 Fax: (1) 631 360 8222 usa.sales@zetex.com	Telephone: (852) 26100 611 Fax: (852) 24250 494 asia.sales@zetex.com	Telephone (44) 161 622 4444 Fax: (44) 161 622 4446 hq@zetex.com

These offices are supported by agents and distributors in major countries world-wide.

This publication is issued to provide outline information only which (unless agreed by the Company in writing) may not be used, applied or reproduced for any purpose or form part of any order or contract or be regarded as a representation relating to the products or services concerned. The Company reserves the right to alter without notice the specification, design, price or conditions of supply of any product or service.

For the latest product information, log on to www.zetex.com

ISSUE 1 - FEBRUARY 2004

Компания «Life Electronics» занимается поставками электронных компонентов импортного и отечественного производства от производителей и со складов крупных дистрибьюторов Европы, Америки и Азии.

С конца 2013 года компания активно расширяет линейку поставок компонентов по направлению коаксиальный кабель, кварцевые генераторы и конденсаторы (керамические, пленочные, электролитические), за счёт заключения дистрибьюторских договоров

Мы предлагаем:

- Конкурентоспособные цены и скидки постоянным клиентам.
- Специальные условия для постоянных клиентов.
- Подбор аналогов.
- Поставку компонентов в любых объемах, удовлетворяющих вашим потребностям.
- Приемлемые сроки поставки, возможна ускоренная поставка.
- Доставку товара в любую точку России и стран СНГ.
- Комплексную поставку.
- Работу по проектам и поставку образцов.
- Формирование склада под заказчика.
- Сертификаты соответствия на поставляемую продукцию (по желанию клиента).
- Тестирование поставляемой продукции.
- Поставку компонентов, требующих военную и космическую приемку.
- Входной контроль качества.
- Наличие сертификата ISO.

В составе нашей компании организован Конструкторский отдел, призванный помогать разработчикам, и инженерам.

Конструкторский отдел помогает осуществить:

- Регистрацию проекта у производителя компонентов.
- Техническую поддержку проекта.
- Защиту от снятия компонента с производства.
- Оценку стоимости проекта по компонентам.
- Изготовление тестовой платы монтаж и пусконаладочные работы.



Тел: +7 (812) 336 43 04 (многоканальный)
Email: org@lifeelectronics.ru