

M4Q Series

Q-Motors

Offer Efficiency and Performance



- 4-pole QUAD design, shaded-pole motor with self-aligning, permanently lubricated sintec bearings; thermally (IP 42 standard, IP 54 available) and impedance protected.
- Square outer dimensions, 83x83mm is considered to be general standard.
- Versatile air movers with choice of impeller sizes blade pitches and accessories.
- Choice of air flow and air direction. From 113 to 1082 CFM. Exhaust over motor or inlet over motor.
- CCW rotation when looking at shaft. This ensures that the screws remain tight and in place.
- UL, CSA, VDE approvals on some models, please contact application engineering.

AC MOTOR	Input		Input	Output			Type of	Bracket	Blade	Blade	Air Flow
Part Number	Volts	Hertz	Watts	Watts	Amps	RPM	Bearing	Type	Series	Pitch °	CFM
M4Q045 -BD03 -04	115	50/60	26	5	0.35	1550	Sleeve	1	154	22	113
M4Q045 -BD01 -01	230	50/60	26	5	0.17	1550	Sleeve	1		28	137
										172	22
									200	28	189
M4Q045 -CA17 -04	115	50/60	30	8	0.40	1550	Sleeve	1	200	22	248
M4Q045 -CA01 -01	230	50/60	30	8	0.20	1550	Sleeve	1		28	274
										230	22
M4Q045 -CA27 -04	115	50/60	34	9	0.45	1550	Sleeve	1	230	22	353
M4Q045 -CA25 -04	230	50/60	34	9	0.22	1550	Sleeve	1		28	440
										254	22
M4Q045 -CF07 -04	115	50/60	58	16	0.74	1550	Sleeve	1	254	22	488
M4Q045 -CF01 -01	230	50/60	58	16	0.36	1550	Sleeve	1			
M4Q045 -DA11 -04	115	50/60	62	18	0.87	1550	Sleeve	2	254	22	494
M4Q045 -DA01 -01	230	50/60	62	18	0.42	1550	Sleeve	2		28	641
										300	22
M4Q045 -DA13 -04	115	50/60	80	25	1.10	1550	Sleeve	2	300	22	876
M4Q045 -DA05 -01	230	50/60	80	25	0.55	1550	Sleeve	2			
M4Q045 -EA03 -04	115	50/60	80	26	1.10	1550	Sleeve	3	300	22	912
M4Q045 -EA01 -01	230	50/60	80	26	0.55	1550	Sleeve	3			
M4Q045 -EF03 -04	115	50/60	100	34	1.35	1550	Sleeve	3	300	22	1008
M4Q045 -EF01 -01	230	50/60	100	34	0.65	1550	Sleeve	3		28	1082



Motor output	Blade dimensions										Assembly dimensions				
			22°		28°		22°		28°		H1	H2	B	E	K
Watt	in	mm	in	in	in	in	in	in	in	in	in	in	in	in	in
5	6.06	154	1.08	0.55	1.38	0.65	2.40	2.20	2.20	2.32	3.54	1.54	2.99	1.65	0.59
5	6.77	172	1.22	0.57	1.42	0.67	2.28	2.24	2.17	2.32	4.06	2.05	2.99	1.65	0.59
5	7.87	200	1.26	0.61	N/A	N/A	2.28	2.28	N/A	N/A	4.84	2.83	2.99	1.65	0.59
8	7.87	200	1.26	0.61	1.48	0.71	2.56	2.28	2.44	2.36	4.84	2.83	3.23	1.65	0.59
8	9.06	230	1.44	0.77	N/A	N/A	2.52	2.44	N/A	N/A	4.84	2.83	3.23	1.65	0.59
9	9.06	230	1.44	0.77	1.77	0.91	2.52	2.44	2.36	2.56	4.84	2.83	3.23	1.65	0.59
9	10.00	254	1.46	0.79	N/A	N/A	2.52	2.44	N/A	N/A	5.31	3.31	3.23	1.65	0.59
16	10.00	254	1.46	0.79	N/A	N/A	2.76	2.44	N/A	N/A	5.31	3.31	3.43	1.65	0.59
18	10.00	254	1.46	0.79	1.77	0.93	2.99	2.91	2.83	3.07	5.31	3.31	3.66	2.13	0.59
18	11.81	300	1.67	0.98	N/A	N/A	2.95	3.11	N/A	N/A	6.30	4.29	3.66	2.13	0.59
25	11.81	300	1.67	0.98	N/A	N/A	2.95	3.11	N/A	N/A	6.30	4.29	3.66	2.13	0.59
26	11.81	300	1.67	0.98	N/A	N/A	3.39	3.31	N/A	N/A	6.30	4.29	4.06	2.32	0.63
34	11.81	300	1.67	0.98	1.91	1.10	4.25	4.09	4.09	4.17	6.30	4.29	4.92	3.11	1.30

A4Q154

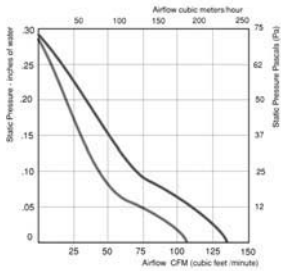

— A4Q154 230V 60Hz 22' pitch M4Q045BD01
 - - A4Q154 230V 60Hz 28' pitch M4Q045BD01

A4Q172

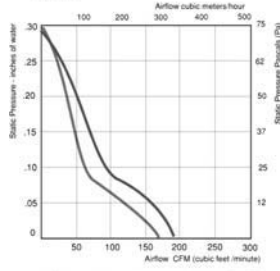

— A4Q172 230V 60Hz 22' pitch M4Q045BD01
 - - A4Q172 230V 60Hz 28' pitch M4Q045BD01

A4Q200

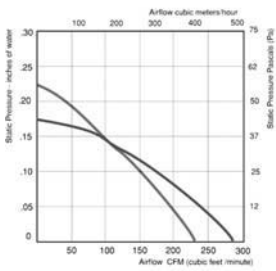

— A4Q200-04B 230V 60Hz 22' pitch M4Q045BD01
 - - A4Q200-05B 230V 60Hz 28' pitch M4Q045BD01

A4Q230-1

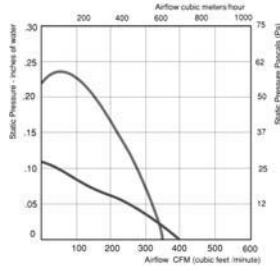

— A4Q230-01B 230V 60Hz 22' pitch M4Q045CA03
 - - A4Q230-02B 230V 60Hz 28' pitch M4Q045CA03

A4Q230-2

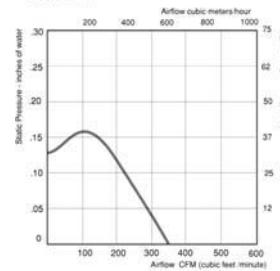

— A4Q230-04B 230V 60Hz 22' pitch M4Q045CA01

A4Q254

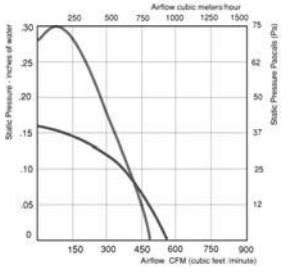

— A4Q254-01B 230V 60Hz 22' pitch M4Q045CF01
 - - A4Q254-02B 230V 60Hz 28' pitch M4Q045CF01

A4Q254-2

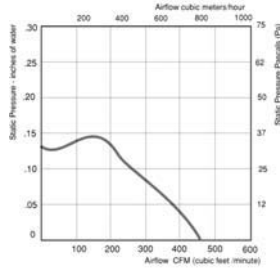

— A4Q254-03B 230V 60Hz 22' pitch M4Q045CA03

A4Q254-3

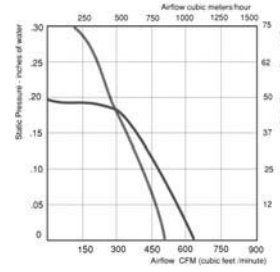

— A4Q254-04B 230V 60Hz 22' pitch M4Q045DA03
 - - A4Q254-05B 230V 60Hz 28' pitch M4Q045DA03

A4Q300-1

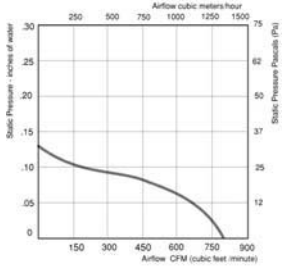

— A4Q300-01B 230V 60Hz 22' pitch M4Q045DA01

A4Q300-2

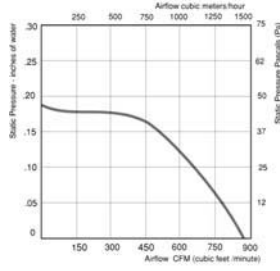

— A4Q300-02B 230V 60Hz 22' pitch M4Q045DA05

A4Q300-3

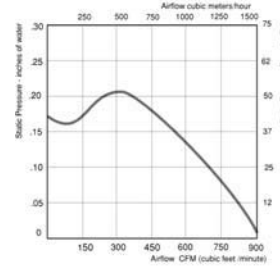

— A4Q300-03B 230V 60Hz 22' pitch M4Q045EA01

A4Q300-4

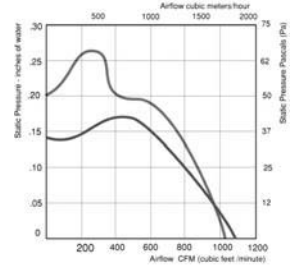

— A4Q300-04B 230V 60Hz 22' pitch M4Q045EF01
 - - A4Q300-05B 230V 60Hz 28' pitch M4Q045EF01

FLAT GRILL GUARD

Impeller Diameter	Flat Guard Part Number	Depth of Guard	Mtg Hole Dia. (B)	Max. Pitch Air Delivery	
				"V"	"A"
154	50967-2-4039	11.5	190	34°	34°
172	50968-2-4039	11.5	208	34°	34°
200	50969-2-4039	11.5	236	34°	28°
230	50970-2-4039	17.5	266	28°	28°
254	50971-2-4039	17.5	290	28°	28°
300	50972-2-4039	17.5	344	-	22°

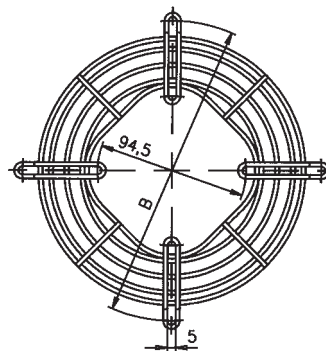

WALL RING for AIR DELIVERY - "A"

Impeller Diameter	Wall Ring ("A") Part Number	Overall Dia. (C)	Mtg Hole Dia. (B)	Max. Pitch Air Delivery	
				"A"	"V"
154	52550-2-4037	200	190	34°	34°
172	52551-2-4037	223	208	34°	34°
200	52552-2-4037	246	236	28°	28°
230	52553-2-4037	276	266	28°	28°
254	52554-2-4037	300	290	28°	28°
300	52555-2-4037	356	344	22°	22°

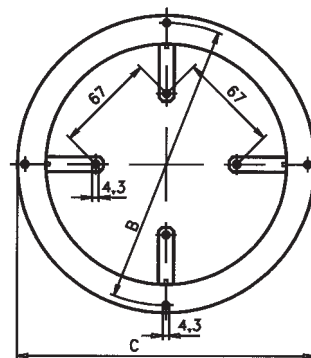

WALL RING for AIR DELIVERY - "V"

Impeller Diameter	Wall Ring ("V") Part Number	Overall Dia. (C)	Mtg Hole Dia. (B)	Max. Pitch Air Delivery	
				"V"	"A"
154	52542-2-4037	200	190	34°	34°
172	52543-2-4037	223	208	34°	34°
200	52544-2-4037	246	236	34°	28°
230	52545-2-4037	276	266	28°	28°
254	52546-2-4037	300	290	28°	28°
300	52547-2-4037	356	344	22°	22°

BASKET GRILL GUARD

Impeller Diameter	Basket Guard Part Number	Depth (C)	Hole Dia(B)	Max. Pitch Air Delivery	
				"V"	"A"
172	66309-2-4039	37.5	208	34°	34°
200	66310-2-4039	37.5	236	34°	28°
230	66311-2-4039	40	266	28°	28°
254	66312-2-4039	40	290	28°	28°
300	66313-2-4039*	46.8	344	-	22°

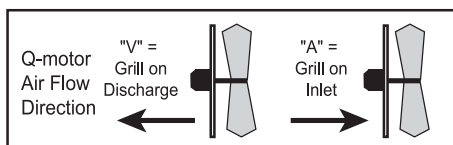

BRACKETS

Motor Series	Bracket Part Number	Bracket Type	H2 (mm)
M4Q045-BD	71881-2-4053	1	39
	71882-2-4053	1	52
	71883-2-4053	1	72
M4Q045-CA	71883-2-4053	1	72
	71884-2-4053	1	84
M4Q045-CF	71884-2-4053	1	84
M4Q045-DA	71885-2-4053	2	84
	71886-2-4053	2	109
M4Q045-DA	71886-2-4053	2	109
M4Q045-EA	71887-2-4053	3	109
M4Q045-EF	71887-2-4053	3	109



Q-Motor Impeller Part Numbers

Part Number (A)	Impeller Size (mm)	Impeller Pitch (°)	Impeller Part Number (V)	Exhaust over motor
73761-2-3634	154	22	73801-2-3634	
73762-2-3634	154	28	73802-2-3634	
73763-2-3634	154	34	73803-2-3634	
73764-2-3634	172	22	73804-2-3634	
73765-2-3634	172	28	73805-2-3634	
73766-2-3634	172	34	73806-2-3634	
73767-2-3634	200	22	73807-2-3634	
73768-2-3634	200	28	73808-2-3634	
73769-2-3634	200	34	73809-2-3634	
73770-2-3634	230	22	73810-2-3634	
73771-2-3634	230	28	73811-2-3634	
73772-2-3634	230	34	73812-2-3634	
73773-2-3634	254	22	73813-2-3634	
73774-2-3634	254	28	73814-2-3634	
73775-2-3634	254	34	73815-2-3634	
73776-2-3634	300	22	73816-2-3634	
73777-2-3634	300	28	73817-2-3634	
73778-2-3634	300	34	73818-2-3634	

Компания «Life Electronics» занимается поставками электронных компонентов импортного и отечественного производства от производителей и со складов крупных дистрибьюторов Европы, Америки и Азии.

С конца 2013 года компания активно расширяет линейку поставок компонентов по направлению коаксиальный кабель, кварцевые генераторы и конденсаторы (керамические, пленочные, электролитические), за счёт заключения дистрибьюторских договоров

Мы предлагаем:

- Конкурентоспособные цены и скидки постоянным клиентам.
- Специальные условия для постоянных клиентов.
- Подбор аналогов.
- Поставку компонентов в любых объемах, удовлетворяющих вашим потребностям.
- Приемлемые сроки поставки, возможна ускоренная поставка.
- Доставку товара в любую точку России и стран СНГ.
- Комплексную поставку.
- Работу по проектам и поставку образцов.
- Формирование склада под заказчика.
- Сертификаты соответствия на поставляемую продукцию (по желанию клиента).
- Тестирование поставляемой продукции.
- Поставку компонентов, требующих военную и космическую приемку.
- Входной контроль качества.
- Наличие сертификата ISO.

В составе нашей компании организован Конструкторский отдел, призванный помогать разработчикам, и инженерам.

Конструкторский отдел помогает осуществить:

- Регистрацию проекта у производителя компонентов.
- Техническую поддержку проекта.
- Защиту от снятия компонента с производства.
- Оценку стоимости проекта по компонентам.
- Изготовление тестовой платы монтаж и пусконаладочные работы.



Тел: +7 (812) 336 43 04 (многоканальный)

Email: org@lifeelectronics.ru