

# FEATURES SELECTION GUIDE

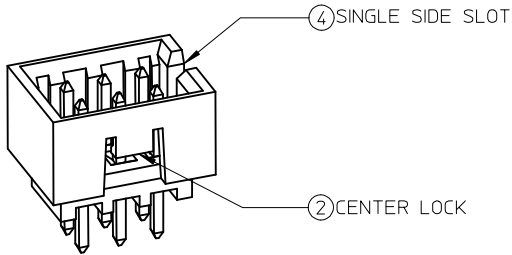

CIRCUIT SIZE	FEATURES						SHEET NO
	FRICTION LOCKS		SIDE SLOTS		5 CENTER POLARIZATION	6 PEG	
	1 DUAL	2 CENTER	3 DUAL	4 SINGLE			
4	N.A	N.A	YES	N.A	N.A	N.A	2 - 3
	N.A	YES	YES	N.A	N.A	N.A	
	N.A	YES	N.A	YES	N.A	N.A	
6	N.A	N.A	YES	N.A	N.A	N.A	4 - 5
	N.A	N.A	YES	N.A	N.A	YES	
	N.A	YES	YES	N.A	N.A	N.A	
	N.A	YES	YES	N.A	N.A	YES	
	N.A	YES	N.A	YES	N.A	YES	
	N.A	YES	N.A	YES	N.A	YES	
	N.A	N.A	YES	N.A	YES	N.A	
8 TO 12	N.A	N.A	YES	N.A	YES	N.A	6 - 8
	N.A	N.A	YES	N.A	YES	YES	
	N.A	YES	YES	N.A	N.A	N.A	
	N.A	YES	YES	N.A	N.A	YES	
	N.A	YES	N.A	YES	N.A	N.A	
	N.A	YES	N.A	YES	N.A	YES	
14 TO 50	YES	N.A	YES	N.A	YES	N.A	9 - 13
	YES	N.A	YES	N.A	YES	YES	

<b>RELEASED</b> EC NO: S2015-1188 DRWG: GMENARLY 2015/04/15 CHK'D: CGOH 2015/06/29 APPR: KHL IM 2015/06/29	QUALITY SYMBOLS	GENERAL TOLERANCES (UNLESS SPECIFIED)	DIMENSION STYLE	SCALE	DESIGN UNITS	THIRD ANGLE PROJECTION
	$\nabla_{\sqrt{A}} = 0$ $\nabla_{\sqrt{C}} = 0$ $\nabla_{\sqrt{P}} = 0$	mm    INCH 4 PLACES ± --- ± --- 3 PLACES ± --- ± --- 2 PLACES ± 0.20 ± --- 1 PLACE ± --- ± --- 0 PLACE ± --- ± ---	MM ONLY	NTS	METRIC	
	DESCRIPTION	ANGULAR ± 3 °	DRAWN BY	DATE	TITLE	
	REV	DRAFT WHERE APPLICABLE MUST REMAIN WITHIN DIMENSIONS	GMENARLY	2015/04/15	MILLIGRID 2MM PITCH, THROUGH HOLE VERTICAL SHROUDED HEADER	
A		SEE TABLE	KHL IM	2015/06/29	<b>molex</b> DOCUMENT NO. SD-87831-0001 SHEET NO. 1 OF 13	
			MATERIAL NO.	THIS DRAWING CONTAINS INFORMATION THAT IS PROPRIETARY TO MOLEX INCORPORATED AND SHOULD NOT BE USED WITHOUT WRITTEN PERMISSION		

4 CIRCUITS

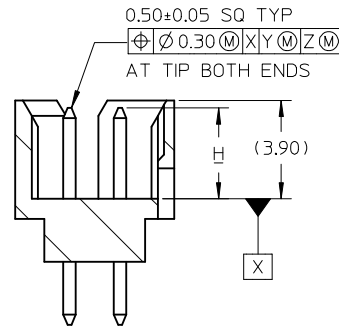
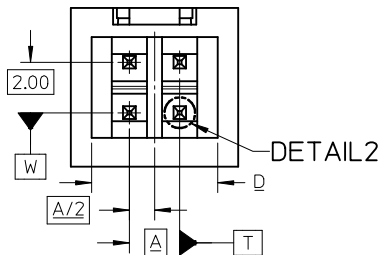
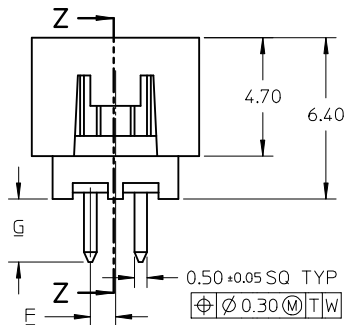
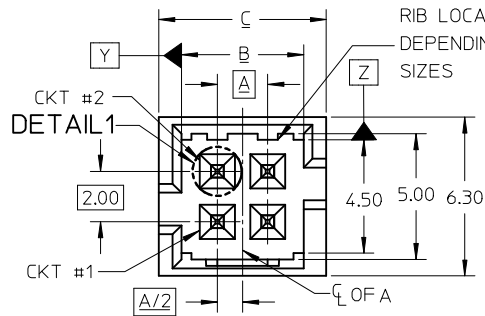

SECTION Z-Z

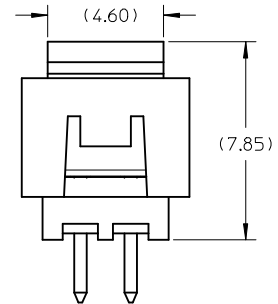
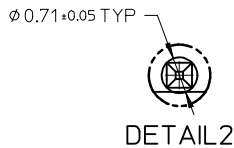
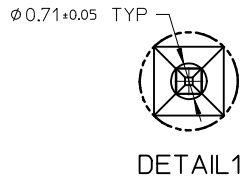

VIEW FOR HEADER WITH CAP

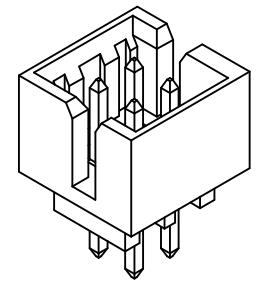

VIEW FOR HEADER WITH ONLY DUAL SLOTS

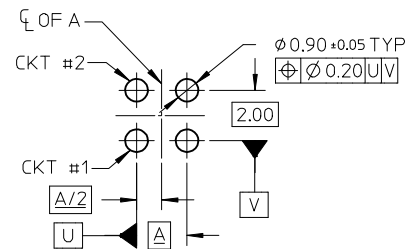

RECOMMENDED PCB LAYOUT

NOTES:

- MATERIALS:  
HOUSING: 30% GF, NYLON, UL94V-0, COLOR: BLACK  
PIN: 0.50MM SQ PHOSPHOR BRONZE
- FINISHES: REFER TO PLATING OPTIONS
- PRODUCT SPECIFICATION: PS-87831-027
- PACKAGING SPECIFICATION:  
TUBE: PK-87831-001, TAPE AND REEL: PK-87831-300
- MATES WITH: A. MOLEX CRIMP RECEPTACLE HOUSING: 51110 SERIES AND CRIMP TERMINAL: 50394 SERIES  
B. MOLEX 2MM MILLIGRID DUAL ROW IDT: 87568 SERIES  
C. MOLEX 2MM MILLIGRID DUAL ROW RECEPTACLE: 79107 (GOLD PLATED), 78787 (TIN PLATED)

RELEASED EC NO: S2015-1188 DRWNG:GMENARLY 2015/04/15 CHKD:CGOH 2015/06/29 APPR:KHLIM 2015/06/29	QUALITY SYMBOLS $F_A=0$ $F_B=0$ $F_P=0$	GENERAL TOLERANCES (UNLESS SPECIFIED)		DIMENSION STYLE	SCALE	DESIGN UNITS	THIRD ANGLE PROJECTION	
				MM ONLY	NTS	METRIC		
		mm	INCH	DRAWN BY	DATE	TITLE		
		4 PLACES ± --- ± ---	3 PLACES ± --- ± ---	GMENARLY	2015/04/15	MILLIGRID 2MM PITCH, THROUGH HOLE VERTICAL SHROUDED HEADER		
2 PLACES ± 0.20 ± ---	1 PLACE ± --- ± ---	CHECKED BY	DATE					
0 PLACE ± --- ± ---		APPROVED BY	DATE				DOCUMENT NO.	SHEET NO.
ANGULAR ± 3°		MATERIAL NO.		SD-87831-0001			2 OF 13	
DRAFT WHERE APPLICABLE MUST REMAIN WITHIN DIMENSIONS		SEE TABLE		THIS DRAWING CONTAINS INFORMATION THAT IS PROPRIETARY TO MOLEX INCORPORATED AND SHOULD NOT BE USED WITHOUT WRITTEN PERMISSION				

4 CIRCUITS

CKT SIZE	ASSY P/N WITHOUT CAP IN TUBE	ASSY P/N WITH CAP IN TUBE	ASSY P/N WITH CAP IN T&R	PLATING OPTIONS	FRICTION LOCKS		SIDE SLOTS		CENTER POLARIZATION	PEG	DIMENSION							
					DUAL	CENTER	DUAL	SINGLE			A	B	C	D	E	F	G	H
4	87831-0419	N.A	N.A	1	N.A	N.A	YES	N.A	N.A	N.A	2.00	4.85	6.65	5.00	N.A	N.A	2.50	3.60±0.20
	87831-0420	N.A	N.A	2														
	87831-0421	N.A	N.A	3														
	87831-0436	N.A	N.A	4														
	87831-0441	87831-0456	N.A	2	N.A	YES	YES	N.A	N.A	N.A						1.00	2.50	
	87831-0442	N.A	N.A	3														
	87831-5141	N.A	N.A	2	N.A	YES	YES	N.A	N.A	N.A						3.50		
	87831-5142	N.A	N.A	3														
	87831-6141	N.A	N.A	2	N.A	YES	YES	N.A	N.A	N.A						2.80		
	87831-6142	N.A	N.A	3														
87831-0443	N.A	N.A	2	N.A	YES	N.A	YES	N.A	N.A	2.50								
87831-0444	N.A	N.A	3															

PLATING OPTIONS:

- 1 - 0.05-0.13um/2-5uin GOLD IN CONTACT AREA AND 1.88um/75uin MIN. MATTE TIN IN SOLDER TAIL AREA OVER 1.27um/50uin MIN. NICKEL OVERALL.
- 2 - 0.38um/15uin GOLD IN CONTACT AREA AND 1.88um/75uin MIN. MATTE TIN IN SOLDER TAIL AREA OVER 1.27um/50uin MIN. NICKEL OVERALL.
- 3 - 0.76um/30uin GOLD IN CONTACT AREA AND 1.88um/75uin MIN. MATTETIN IN SOLDER TAIL AREA OVER 1.27um/50uin MIN. NICKEL OVERALL.
- 4 - 2.50um/100uin MIN. MATTE TIN OVER 1.25um/50uin MIN. NICKEL OVERALL.

RELEASED EC NO: S2015-1188 DRW:GMENARLY 2015/04/15 CHKD:CGOH 2015/06/29 APPR:KHLIM 2015/06/29	DESCRIPTION QUALITY SYMBOLS $F_A=0$ $F_G=0$ $F_P=0$	GENERAL TOLERANCES (UNLESS SPECIFIED)		DIMENSION STYLE	SCALE	DESIGN UNITS	THIRD ANGLE PROJECTION	
				MM ONLY	NTS	METRIC		
		4 PLACES	± --- ± ---	DRAWN BY	DATE	TITLE		
		3 PLACES	± --- ± ---	GMENARLY	2015/04/15	MILLIGRID		
2 PLACES	± 0.20 ± ---	CHECKED BY	DATE	2MM PITCH, THROUGH HOLE				
1 PLACE	± --- ± ---	APPROVED BY	DATE	VERTICAL SHROUDED HEADER				
0 PLACE	± --- ± ---	KHLIM	2015/06/29	<b>molex</b>				
ANGULAR ± 3 °		MATERIAL NO.	DOCUMENT NO.	SD-87831-0001				
DRAFT WHERE APPLICABLE MUST REMAIN WITHIN DIMENSIONS		SEE TABLE		SHEET NO. 3 OF 13				
		SIZE A3	THIS DRAWING CONTAINS INFORMATION THAT IS PROPRIETARY TO MOLEX INCORPORATED AND SHOULD NOT BE USED WITHOUT WRITTEN PERMISSION					



6 CIRCUITS

CKT SIZE	ASSY P/N WITHOUT CAP IN TUBE	ASSY P/N WITH CAP IN TUBE	ASSY P/N WITH CAP IN T&R	PLATING OPTIONS	FRICTION LOCKS		SIDE SLOTS		CENTER POLARIZATION	PEG	DIMENSION								
					DUAL	CENTER	DUAL	SINGLE			A	B	C	D	E	F	G	H	
6	87831-0619	N.A	N.A	1	N.A	N.A	YES	N.A	N.A	N.A	4.00	6.85	8.65	7.00	N.A	N.A	2.50	3.60±0.20	
	87831-0620	N.A	N.A	2															
	87831-0621	N.A	N.A	3															
	87831-0636	N.A	N.A	4															
	87831-0628	N.A	N.A	2	N.A	N.A	YES	N.A	N.A	YES						N.A	N.A		2.50
	87831-0629	N.A	N.A	3															
	87831-0641	N.A	N.A	2	N.A	YES	YES	N.A	N.A	N.A						2.50			
	87831-0642	N.A	87831-5552	3															
	87831-5241	N.A	N.A	2															
	87831-5242	N.A	N.A	3	N.A	YES	YES	N.A	N.A	N.A						3.50			
	87831-6241	N.A	N.A	2															
	87831-6242	N.A	N.A	3	N.A	YES	YES	N.A	N.A	N.A						2.80			
	87831-0643	N.A	N.A	2															
	87831-0644	N.A	N.A	3															
	87831-0645	N.A	N.A	2															
	87831-0646	N.A	N.A	3	N.A	YES	N.A	YES	N.A	YES						2.50			
87831-0632	N.A	N.A	2																
87831-5119	N.A	N.A	1	N.A	N.A	YES	N.A	YES	N.A	N.A	N.A	2.50	3.60±0.20						

PLATING OPTIONS:

- 1 - 0.05-0.13um/2-5uin GOLD IN CONTACT AREA AND 1.88um/75uin MIN. MATTE TIN IN SOLDER TAIL AREA OVER 1.27um/50uin MIN. NICKEL OVERALL.
- 2 - 0.38um/15uin GOLD IN CONTACT AREA AND 1.88um/75uin MIN. MATTE TIN IN SOLDER TAIL AREA OVER 1.27um/50uin MIN. NICKEL OVERALL.
- 3 - 0.76um/30uin GOLD IN CONTACT AREA AND 1.88um/75uin MIN. MATTE TIN IN SOLDER TAIL AREA OVER 1.27um/50uin MIN. NICKEL OVERALL.
- 4 - 2.50um/100uin MIN. MATTE TIN OVER 1.25um/50uin MIN. NICKEL OVERALL.

RELEASED EC NO: S2015-1188 DRW:GMENARLY 2015/04/15 CHKD:CGOH 2015/06/29 APPR:KHL IM 2015/06/29	DESCRIPTION QUALITY SYMBOLS $F_A=0$ $F_G=0$ $F_P=0$	GENERAL TOLERANCES (UNLESS SPECIFIED)		DIMENSION STYLE MM ONLY		SCALE NTS	DESIGN UNITS METRIC	THIRD ANGLE PROJECTION				
				mm	INCH	DRAWN BY GMENARLY	DATE 2015/04/15	TITLE MILLIGRID 2MM PITCH, THROUGH HOLE VERTICAL SHROUDED HEADER				
				4 PLACES ± --- ± ---	3 PLACES ± --- ± ---	CHECKED BY		DATE				
				2 PLACES ± 0.20 ± ---	1 PLACE ± --- ± ---	APPROVED BY KHL IM		DATE 2015/06/29				
		0 PLACE ± --- ± ---	ANGULAR ± 3 °		MATERIAL NO.		DOCUMENT NO.		SHEET NO.			
		DRAFT WHERE APPLICABLE MUST REMAIN WITHIN DIMENSIONS		SEE TABLE		SD-87831-0001		5 OF 13				
		THIS DRAWING CONTAINS INFORMATION THAT IS PROPRIETARY TO MOLEX INCORPORATED AND SHOULD NOT BE USED WITHOUT WRITTEN PERMISSION										

8 TO 12 CIRCUITS

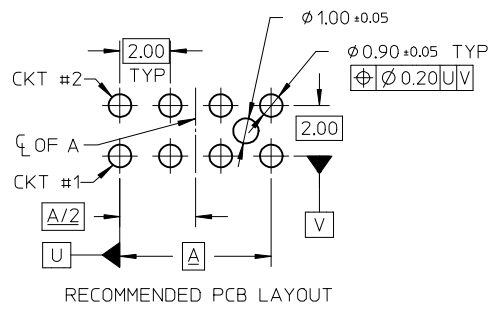
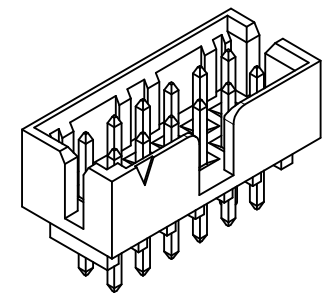
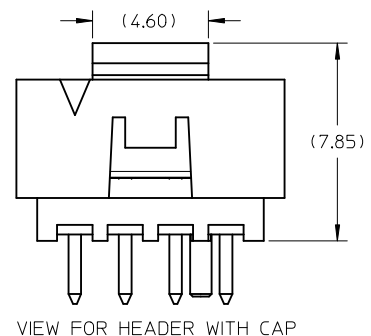
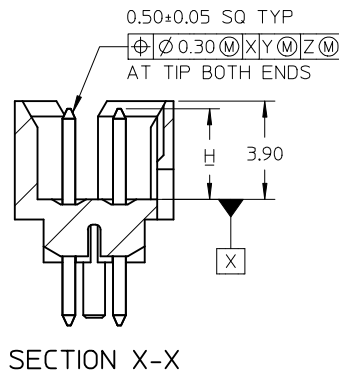
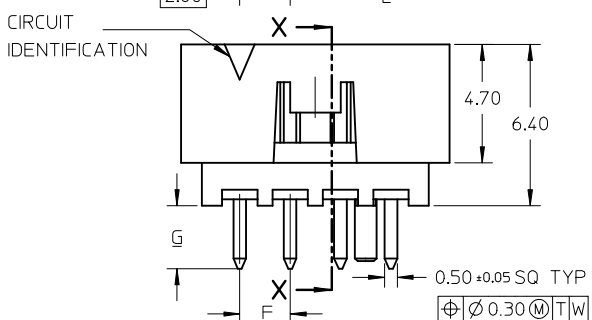

- NOTES:
- MATERIALS:  
HOUSING: 30% GF, NYLON, UL94V-0, COLOR: BLACK  
PIN: 0.50MM SQ PHOSPHOR BRONZE
  - FINISHES: REFER TO PLATING OPTIONS
  - PRODUCT SPECIFICATION: PS-87831-027
  - PACKAGING SPECIFICATION:  
TUBE: PK-87831-001, TAPE AND REEL: PK-87831-300
  - MATES WITH: A. MOLEX CRIMP RECEPTACLE HOUSING: 51110 SERIES AND CRIMP TERMINAL: 50394 SERIES  
B. MOLEX 2MM MILLIGRID DUAL ROW IDT: 87568 SERIES  
C. MOLEX 2MM MILLIGRID DUAL ROW RECEPTACLE: 79107 (GOLD PLATED), 78787 (TIN PLATED)

RELEASED EC NO: S2015-1188 DRWN:GMENARLY 2015/04/15 CHKD:CGOH 2015/06/29 APPR:KHLIM 2015/06/29	DESCRIPTION QUALITY SYMBOLS $\nabla_A=0$ $\nabla_E=0$ $\nabla_F=0$	GENERAL TOLERANCES (UNLESS SPECIFIED)		DIMENSION STYLE MM ONLY		SCALE NTS	DESIGN UNITS METRIC	THIRD ANGLE PROJECTION		
		4 PLACES	± ---	± ---	DRAWN BY GMENARLY	DATE 2015/04/15	TITLE MILLIGRID 2MM PITCH, THROUGH HOLE VERTICAL SHROUDED HEADER <b>molex</b>			
		3 PLACES	± ---	± ---	CHECKED BY	DATE				
		2 PLACES	± 0.20	± ---	APPROVED BY KHLIM	DATE 2015/06/29	DOCUMENT NO. SD-87831-0001		SHEET NO. 6 OF 13	
1 PLACE	± ---	± ---	MATERIAL NO.		SEE TABLE					
0 PLACE	± ---	± ---	ANGULAR ± 3 °		THIS DRAWING CONTAINS INFORMATION THAT IS PROPRIETARY TO MOLEX INCORPORATED AND SHOULD NOT BE USED WITHOUT WRITTEN PERMISSION					
DRAFT WHERE APPLICABLE MUST REMAIN WITHIN DIMENSIONS										

8 CIRCUITS

F	CKT SIZE	ASSY P/N WITHOUT CAP IN TUBE	ASSY P/N WITH CAP IN TUBE	ASSY P/N WITH CAP IN T&R	PLATING OPTIONS	FRICTION LOCKS		SIDE SLOTS		CENTER POLARIZATION	PEG	DIMENSION														
						DUAL	CENTER	DUAL	SINGLE			A	B	C	D	E	F	G	H							
E	8	87831-0819	N.A	N.A	1	N.A	N.A	YES	N.A	YES	N.A	6.00	8.85	10.65	9.00	N.A	N.A	2.50	3.60±0.20							
	87831-0820	N.A	N.A	2																						
	87831-0821	N.A	N.A	3																						
	87831-0836	N.A	N.A	4	N.A	N.A	YES	N.A	YES	YES	YES						N.A	2.50								
	87831-0828	N.A	N.A	2																						
	87831-0829	N.A	N.A	3																						
	87831-0841	N.A	87831-5551	2	N.A	YES	YES	N.A	N.A	N.A	N.A						3.00	2.50								
	87831-0842	N.A	N.A	3																						
	87831-5441	N.A	N.A	2													N.A	YES		YES	N.A	N.A	N.A	N.A	3.50	
	87831-5442	N.A	N.A	3																						
	N.A	87831-5541	N.A	2	N.A	YES	YES	N.A	N.A	N.A	N.A						2.80									
	N.A	87831-5542	N.A	3																						
	D	8	87831-5741	N.A	N.A	2	N.A	YES	YES	N.A	N.A						N.A	6.00		8.85	10.65	9.00	N.A	3.00	4.70	3.60 <sup>+0.15</sup> <sub>-0.10</sub>
		87831-5742	N.A	N.A	3																					
		87831-0832	N.A	N.A	2	N.A	YES	YES	N.A	N.A	YES						YES							2.50		
87831-0843		N.A	N.A	2																						
87831-0844		N.A	N.A	3	N.A	YES	N.A	YES	N.A	N.A	2.50															
87831-0845		N.A	N.A	2																						
87831-0846		N.A	N.A	3	N.A	YES	N.A	YES	N.A	YES	YES	2.50														

PLATING OPTIONS:

- 1 - 0.05-0.13um/2-5uin GOLD IN CONTACT AREA AND 1.88um/75uin MIN. MATTE TIN IN SOLDER TAIL AREA OVER 1.27um/50uin MIN. NICKEL OVERALL.
- 2 - 0.38um/15uin GOLD IN CONTACT AREA AND 1.88um/75uin MIN. MATTE TIN IN SOLDER TAIL AREA OVER 1.27um/50uin MIN. NICKEL OVERALL.
- 3 - 0.76um/30uin GOLD IN CONTACT AREA AND 1.88um/75uin MIN. MATTE TIN IN SOLDER TAIL AREA OVER 1.27um/50uin MIN. NICKEL OVERALL.
- 4 - 2.50um/100uin MIN. MATTE TIN OVER 1.25um/50uin MIN. NICKEL OVERALL.

RELEASED EC NO: S2015-1188 DRAWN: GEMEARLY 2015/04/15 CH'KD: CGOH 2015/06/29 APPR: KHL IM 2015/06/29	REV DESCRIPTION	QUALITY SYMBOLS	GENERAL TOLERANCES (UNLESS SPECIFIED)	DIMENSION STYLE	SCALE	DESIGN UNITS	THIRD ANGLE PROJECTION	
		$F_A=0$ $F_G=0$ $F_P=0$	mm    INCH 4 PLACES ± --- ± --- 3 PLACES ± --- ± --- 2 PLACES ± 0.20 ± --- 1 PLACE ± --- ± --- 0 PLACE ± --- ± ---	MM ONLY	NTS	METRIC	DRAWN BY: GMENARLY DATE: 2015/04/15 CHECKED BY: _____ DATE: _____	MILLIGRID 2MM PITCH, THROUGH HOLE VERTICAL SHROUDED HEADER 
		ANGULAR ± 3 ° DRAFT WHERE APPLICABLE MUST REMAIN WITHIN DIMENSIONS	APPROVED BY: KHL IM DATE: 2015/06/29 MATERIAL NO. SEE TABLE DOCUMENT NO. SD-87831-0001	SHEET NO. 7 OF 13				
		THIS DRAWING CONTAINS INFORMATION THAT IS PROPRIETARY TO MOLEX INCORPORATED AND SHOULD NOT BE USED WITHOUT WRITTEN PERMISSION						

10 TO 12 CIRCUITS

CKT SIZE	ASSY P/N WITHOUT CAP IN TUBE	ASSY P/N WITH CAP IN TUBE	ASSY P/N WITH CAP IN T&R	PLATING OPTIONS	FRICTION LOCKS		SIDE SLOTS		CENTER POLARIZATION	PEG	DIMENSION							
					DUAL	CENTER	DUAL	SINGLE			A	B	C	D	E	F	G	H
10	87831-1019	N.A	N.A	1	N.A	N.A	YES	N.A	YES	N.A	8.00	10.85	12.65	11.00	N.A	N.A	2.50	3.60±0.20
	87831-1020	N.A	N.A	2														
	87831-1021	N.A	N.A	3														
	87831-1036	N.A	N.A	4														
	87831-1010	N.A	N.A	2														
	87831-1011	N.A	N.A	3														
	87831-1028	N.A	N.A	2	N.A	N.A	YES	N.A	YES	YES						2.50		
	87831-1029	N.A	N.A	3														
	87831-1035	N.A	N.A	3														
	87831-1041	N.A	N.A	2	N.A	YES	YES	N.A	N.A	N.A						2.50		
	87831-1042	N.A	87831-5553	3														
	87831-1032	N.A	N.A	2														
87831-1043	N.A	N.A	2	N.A	YES	N.A	YES	N.A	N.A	2.50								
87831-1044	N.A	N.A	3															
87831-1045	N.A	N.A	2															
87831-1046	N.A	N.A	3	N.A	YES	N.A	YES	N.A	YES	2.50								
87831-1219	N.A	N.A	1															
87831-1220	N.A	N.A	2															
12	87831-1221	N.A	N.A	3	N.A	N.A	YES	N.A	YES	N.A	10.00	12.85	14.65	13.00	N.A	N.A	2.50	3.60±0.20
	87831-1236	N.A	N.A	4														
	87831-1228	N.A	N.A	2														
	87831-1229	N.A	N.A	3														
	87831-1241	N.A	N.A	2														
	87831-1242	N.A	N.A	3														
	87831-1255	87831-1256	N.A	2	N.A	YES	YES	N.A	N.A	N.A						3.50		
	87831-1232	N.A	N.A	2														
	87831-1243	N.A	N.A	2														
	87831-1244	N.A	N.A	3	N.A	YES	N.A	YES	N.A	N.A						2.50		
	87831-1245	N.A	N.A	2														
	87831-1246	N.A	N.A	3														

**PLATING OPTIONS:**

- 0.05-0.13um/2-5uin GOLD IN CONTACT AREA AND 1.88um/75uin MIN. MATTE TIN IN SOLDER TAIL AREA OVER 1.27um/50uin MIN. NICKEL OVERALL.
- 0.38um/15uin GOLD IN CONTACT AREA AND 1.88um/75uin MIN. MATTE TIN IN SOLDER TAIL AREA OVER 1.27um/50uin MIN. NICKEL OVERALL.
- 0.76um/30uin GOLD IN CONTACT AREA AND 1.88um/75uin MIN. MATTE TIN IN SOLDER TAIL AREA OVER 1.27um/50uin MIN. NICKEL OVERALL.
- 2.50um/100uin MIN. MATTE TIN OVER 1.25um/50uin MIN. NICKEL OVERALL.

<b>RELEASED</b> EC NO: S2015-1188 DRWING:GMENARLY 2015/04/15 CHK'D:CGOH 2015/06/29 APPR:KHL IM 2015/06/29	QUALITY SYMBOLS $F_A=0$ $F_G=0$ $F_P=0$	GENERAL TOLERANCES (UNLESS SPECIFIED)		DIMENSION STYLE <b>MM ONLY</b>		SCALE NTS	DESIGN UNITS METRIC	THIRD ANGLE PROJECTION			
		4 PLACES ± --- ± ---	mm INCH	DRAWN BY GMENARLY	DATE 2015/04/15	TITLE MILLIGRID 2MM PITCH, THROUGH HOLE VERTICAL SHROUDED HEADER					
		3 PLACES ± --- ± ---		CHECKED BY	DATE	APPROVED BY KHL IM					
		2 PLACES ± 0.20 ± ---		APPROVED BY KHL IM	DATE 2015/06/29	MATERIAL NO.					
DRAFT WHERE APPLICABLE MUST REMAIN WITHIN DIMENSIONS		SEE TABLE		DOCUMENT NO. SD-87831-0001		SHEET NO. 8 OF 13					
THIS DRAWING CONTAINS INFORMATION THAT IS PROPRIETARY TO MOLEX INCORPORATED AND SHOULD NOT BE USED WITHOUT WRITTEN PERMISSION											



14 TO 50 CIRCUITS



SECTION W-W



DETAIL5



DETAIL6



RECOMMENDED PCB LAYOUT

NOTES:

- MATERIALS:  
HOUSING: 30% GF, NYLON, UL94V-0, COLOR: BLACK  
PIN: 0.50MM SQ PHOSPHOR BRONZE
- FINISHES: REFER TO PLATING OPTIONS
- PRODUCT SPECIFICATION: PS-87831-027
- PACKAGING SPECIFICATION:  
TUBE: PK-87831-001, TAPE AND REEL: PK-87831-300
- MATES WITH: A. MOLEX CRIMP RECEPTACLE HOUSING: 51110 SERIES AND CRIMP TERMINAL: 50394 SERIES  
B. MOLEX 2MM MILLIGRID DUAL ROW IDT: 87568 SERIES  
C. MOLEX 2MM MILLIGRID DUAL ROW RECEPTACLE: 79107 (GOLD PLATED), 78787 (TIN PLATED)

RELEASED EC NO: S2015-1188 DRWN:GMENARLY CHKD:CGOH APPR:KHL IM	2015/04/15 2015/06/29 2015/06/29	DESCRIPTION QUALITY SYMBOLS $F_A=0$ $F_C=0$ $F_P=0$	GENERAL TOLERANCES (UNLESS SPECIFIED)		DIMENSION STYLE	SCALE	DESIGN UNITS	THIRD ANGLE PROJECTION				
			mm	INCH	MM ONLY	NTS	METRIC					
			4 PLACES	± ---	± ---	DRAWN BY	DATE	TITLE				
			3 PLACES	± ---	± ---	GMENARLY	2015/04/15	MILLIGRID 2MM PITCH, THROUGH HOLE VERTICAL SHROUDED HEADER <b>molex</b>				
2 PLACES	± 0.20	± ---	CHECKED BY	DATE								
1 PLACE	± ---	± ---	APPROVED BY	DATE	DOCUMENT NO. SD-87831-0001 SHEET NO. 9 OF 13							
0 PLACE	± ---	± ---	KHL IM	2015/06/29								
ANGULAR ± 3 °			DRAFT WHERE APPLICABLE MUST REMAIN WITHIN DIMENSIONS		SIZE	THIS DRAWING CONTAINS INFORMATION THAT IS PROPRIETARY TO MOLEX INCORPORATED AND SHOULD NOT BE USED WITHOUT WRITTEN PERMISSION						
SEE TABLE					A3							

14 TO 20 CIRCUITS

F	CKT SIZE	ASSY P/N WITHOUT CAP IN TUBE	ASSY P/N WITH CAP IN TUBE	ASSY P/N WITH CAP IN T&R	PLATING OPTIONS	FRICTION LOCKS		SIDE SLOTS		CENTER POLARIZATION	PEG	DIMENSION							
						DUAL	CENTER	DUAL	SINGLE			A	B	C	D	E	F	G	H
E	14	87831-1419	N.A	N.A	1	YES	N.A	YES	N.A	YES	N.A	12.00	14.85	16.65	15.00	8.00	N.A	2.50	3.60±0.20
		87831-1420	N.A	87831-5554	2														
		87831-1421	N.A	N.A	3														
		87831-1436	N.A	N.A	4														
		87831-1428	N.A	N.A	2														
		87831-1429	N.A	N.A	3														
		87831-1435	N.A	N.A	3														
D	16	87831-1410	N.A	N.A	2	YES	N.A	YES	N.A	YES	N.A	14.00	16.85	18.65	17.00	10.00	N.A	2.50	3.60±0.20
		87831-1411	N.A	N.A	3														
		87831-1619	N.A	N.A	1														
		87831-1620	N.A	N.A	2														
		87831-1621	N.A	N.A	3														
		87831-1636	N.A	N.A	4														
		87831-1628	N.A	N.A	2														
C	18	87831-1629	N.A	N.A	3	YES	N.A	YES	N.A	YES	N.A	16.00	18.85	20.65	19.00	12.00	N.A	2.50	3.60±0.20
		87831-1819	N.A	N.A	1														
		87831-1820	N.A	N.A	2														
		87831-1821	N.A	N.A	3														
		87831-1836	N.A	N.A	4														
		87831-1828	N.A	N.A	2														
A	20	87831-1829	N.A	N.A	3	YES	N.A	YES	N.A	YES	N.A	18.00	20.85	22.65	21.00	14.00	N.A	2.50	3.60±0.20
		87831-2019	N.A	N.A	1														
		87831-2020	N.A	N.A	2														
		87831-2021	N.A	N.A	3														
		87831-2036	N.A	N.A	4														
		87831-2028	N.A	N.A	2														
		87831-2029	N.A	N.A	3														
		87831-2035	N.A	N.A	3														
87831-2010	N.A	N.A	2																
87831-2011	N.A	N.A	3																

- PLATING OPTIONS:**
- 1 - 0.05-0.13um/2-5uin GOLD IN CONTACT AREA AND 1.88um/75uin MIN. MATTE TIN IN SOLDER TAIL AREA OVER 1.27um/50uin MIN. NICKEL OVERALL.
  - 2 - 0.38um/15uin GOLD IN CONTACT AREA AND 1.88um/75uin MIN. MATTE TIN IN SOLDER TAIL AREA OVER 1.27um/50uin MIN. NICKEL OVERALL.
  - 3 - 0.76um/30uin GOLD IN CONTACT AREA AND 1.88um/75uin MIN. MATTE TIN IN SOLDER TAIL AREA OVER 1.27um/50uin MIN. NICKEL OVERALL.
  - 4 - 2.50um/100uin MIN. MATTE TIN OVER 1.25um/50uin MIN. NICKEL OVERALL.

RELEASED EC NO: S2015-1188 DRW:GMENARLY 2015/04/15 CHKD:CGOH 2015/06/29 APPR:KHL IM 2015/06/29	DESCRIPTION REV A	QUALITY SYMBOLS	GENERAL TOLERANCES (UNLESS SPECIFIED)	DIMENSION STYLE	SCALE	DESIGN UNITS	THIRD ANGLE PROJECTION		
		$F_A=0$ $F_G=0$ $F_P=0$	mm    INCH 4 PLACES ± --- ± --- 3 PLACES ± --- ± --- 2 PLACES ± 0.20 ± --- 1 PLACE ± --- ± --- 0 PLACE ± --- ± ---	MM ONLY	NTS	METRIC	DRAWN BY: GMENARLY DATE: 2015/04/15 CHECKED BY: _____ DATE: _____ APPROVED BY: KHL IM DATE: 2015/06/29	TITLE MILLIGRID 2MM PITCH, THROUGH HOLE VERTICAL SHROUDED HEADER	
		ANGULAR ± 3 ° DRAFT WHERE APPLICABLE MUST REMAIN WITHIN DIMENSIONS	MATERIAL NO. SEE TABLE	DOCUMENT NO. SD-87831-0001	SHEET NO. 10 OF 13				
		THIS DRAWING CONTAINS INFORMATION THAT IS PROPRIETARY TO MOLEX INCORPORATED AND SHOULD NOT BE USED WITHOUT WRITTEN PERMISSION							

22 TO 30 CIRCUITS

F	CKT SIZE	ASSY P/N WITHOUT CAP IN TUBE	ASSY P/N WITH CAP IN TUBE	ASSY P/N WITH CAP IN T&R	PLATING OPTIONS	FRICTION LOCKS		SIDE SLOTS		CENTER POLARIZATION	PEG	DIMENSION						
						DUAL	CENTER	DUAL	SINGLE			A	B	C	D	E	F	G
22	87831-2219	N.A	N.A	1	YES	N.A	YES	N.A	YES	N.A	20.00	22.85	24.65	23.00	16.00	N.A	2.50	3.60±0.20
	87831-2220	N.A	N.A	2														
	87831-2221	N.A	N.A	3														
	87831-2236	N.A	N.A	4														
	87831-2228	N.A	N.A	2														
87831-2229	N.A	N.A	3	YES	N.A	YES	N.A	YES	YES	2.50								
24	87831-2419	N.A	N.A	1	YES	N.A	YES	N.A	YES	N.A	22.00	24.85	26.65	25.00	18.00	N.A	2.50	3.60±0.20
	87831-2420	N.A	N.A	2														
	87831-2421	N.A	N.A	3														
	87831-2436	N.A	N.A	4														
	87831-2428	N.A	N.A	2														
	87831-2429	N.A	N.A	3														
	87831-2435	N.A	N.A	3														
87831-2410	N.A	N.A	2	YES	N.A	YES	N.A	YES	N.A	3.50								
26	87831-2619	N.A	N.A	1	YES	N.A	YES	N.A	YES	N.A	24.00	26.85	28.65	27.00	20.00	N.A	2.50	3.60±0.20
	87831-2620	N.A	N.A	2														
	87831-2621	N.A	N.A	3														
	87831-2636	N.A	N.A	4														
	87831-2628	N.A	N.A	2														
	87831-2629	N.A	N.A	3														
	87831-2610	N.A	N.A	2														
28	87831-2819	N.A	N.A	1	YES	N.A	YES	N.A	YES	N.A	26.00	28.85	30.65	29.00	22.00	N.A	2.50	3.60±0.20
	87831-2820	N.A	N.A	2														
	87831-2821	N.A	N.A	3														
	87831-2836	N.A	N.A	4														
	87831-2828	N.A	N.A	2														
	87831-2829	N.A	N.A	3														
30	87831-3019	N.A	N.A	1	YES	N.A	YES	N.A	YES	N.A	28.00	30.85	32.65	31.00	24.00	N.A	2.50	3.60±0.20
	87831-3020	N.A	N.A	2														
	87831-3021	N.A	N.A	3														
	87831-3036	N.A	N.A	4														
	87831-3028	N.A	N.A	2														
	87831-3029	N.A	N.A	3														
	87831-3035	N.A	N.A	3														
87831-3010	87831-3030	87831-3050	2	YES	N.A	YES	N.A	YES	N.A	3.50								

PLATING OPTIONS:

- 1 - 0.05-0.13um/2-5uin GOLD IN CONTACT AREA AND 1.88um/75uin MIN. MATTE TIN IN SOLDER TAIL AREA OVER 1.27um/50uin MIN. NICKEL OVERALL.
- 2 - 0.38um/15uin GOLD IN CONTACT AREA AND 1.88um/75uin MIN. MATTE TIN IN SOLDER TAIL AREA OVER 1.27um/50uin MIN. NICKEL OVERALL.
- 3 - 0.76um/30uin GOLD IN CONTACT AREA AND 1.88um/75uin MIN. MATTE TIN IN SOLDER TAIL AREA OVER 1.27um/50uin MIN. NICKEL OVERALL.
- 4 - 2.50um/100uin MIN. MATTE TIN OVER 1.25um/50uin MIN. NICKEL OVERALL.

RELEASED  
 IEC NO: S2015-1188  
 DRW:GMENARLY 2015/04/15  
 CH:KD:G0H 2015/06/29  
 APPR:KHL IM 2015/06/29

QUALITY SYMBOLS  
 F<sub>A</sub>=0  
 F<sub>C</sub>=0  
 F<sub>B</sub>=0

GENERAL TOLERANCES (UNLESS SPECIFIED)

	mm	INCH
4 PLACES	± ---	± ---
3 PLACES	± ---	± ---
2 PLACES	± 0.20	± ---
1 PLACE	± ---	± ---
0 PLACE	± ---	± ---

ANGULAR ± 3 °  
 DRAFT WHERE APPLICABLE MUST REMAIN WITHIN DIMENSIONS

DIMENSION STYLE  
**MM ONLY**

SCALE  
**NTS**

DESIGN UNITS  
**METRIC**

THIRD ANGLE PROJECTION

DRAWN BY: GMENARLY  
 DATE: 2015/04/15

CHECKED BY: \_\_\_\_\_  
 DATE: \_\_\_\_\_

APPROVED BY: KHL IM  
 DATE: 2015/06/29

MATERIAL NO. \_\_\_\_\_  
 DOCUMENT NO. SD-87831-0001

SHEET NO. 11 OF 13

MILLIGRID  
 2MM PITCH, THROUGH HOLE  
 VERTICAL SHROUDED HEADER

**molex**

THIS DRAWING CONTAINS INFORMATION THAT IS PROPRIETARY TO MOLEX INCORPORATED AND SHOULD NOT BE USED WITHOUT WRITTEN PERMISSION

32 TO 40 CIRCUITS

CKT SIZE	ASSY P/N WITHOUT CAP IN TUBE	ASSY P/N WITH CAP IN TUBE	ASSY P/N WITH CAP IN T&R	PLATING OPTIONS	FRICTION LOCKS		SIDE SLOTS		CENTER POLARIZATION	PEG	DIMENSION														
					DUAL	CENTER	DUAL	SINGLE			A	B	C	D	E	F	G	H							
32	87831-3219	N.A	N.A	1	YES	N.A	YES	N.A	YES	N.A	30.00	32.85	34.65	33.00	26.00	N.A	2.50	3.60±0.20							
	87831-3220	N.A	N.A	2																					
	87831-3221	N.A	N.A	3																					
	87831-3236	N.A	N.A	4																					
	87831-3228	N.A	N.A	2																					
87831-3229	N.A	N.A	3	YES	N.A	YES	N.A	YES	YES	2.50															
34	87831-3419	N.A	N.A	1	YES	N.A	YES	N.A	YES	N.A	32.00	34.85	36.65	35.00	28.00	N.A	2.50	3.60±0.20							
	87831-3420	N.A	N.A	2																					
	87831-3421	N.A	N.A	3																					
	87831-3436	N.A	N.A	4																					
	87831-3428	N.A	N.A	2																					
	87831-3429	N.A	N.A	3															YES	N.A	YES	N.A	YES	YES	2.50
87831-3435	N.A	N.A	3	YES	N.A	YES	N.A	YES	YES	3.50															
36	87831-3619	N.A	N.A	1	YES	N.A	YES	N.A	YES	N.A	34.00	36.85	38.65	37.00	30.00	N.A	2.50	3.60±0.20							
	87831-3620	N.A	N.A	2																					
	87831-3621	N.A	N.A	3																					
	87831-3636	N.A	N.A	4																					
	87831-3628	N.A	N.A	2																					
	87831-3629	N.A	N.A	3															YES	N.A	YES	N.A	YES	YES	2.50
38	87831-3819	N.A	N.A	1	YES	N.A	YES	N.A	YES	N.A	36.00	38.85	40.65	39.00	32.00	N.A	2.50	3.60±0.20							
	87831-3820	N.A	N.A	2																					
	87831-3821	N.A	N.A	3																					
	87831-3836	N.A	N.A	4																					
	87831-3828	N.A	N.A	2																					
	87831-3829	N.A	N.A	3															YES	N.A	YES	N.A	YES	YES	2.50
40	87831-4019	N.A	N.A	1	YES	N.A	YES	N.A	YES	N.A	38.00	40.85	42.65	41.00	34.00	N.A	2.50	3.60±0.20							
	87831-4020	N.A	N.A	2																					
	87831-4021	N.A	N.A	3																					
	87831-4036	N.A	N.A	4																					
	87831-4028	N.A	N.A	2																					
	87831-4029	N.A	N.A	3															YES	N.A	YES	N.A	YES	YES	2.50
	87831-4010	N.A	N.A	2															YES	N.A	YES	N.A	YES	N.A	3.50

**PLATING OPTIONS:**

- 0.05-0.13um/2-5uin GOLD IN CONTACT AREA AND 1.88um/75uin MIN. MATTE TIN IN SOLDER TAIL AREA OVER 1.27um/50uin MIN. NICKEL OVERALL.
- 0.38um/15uin GOLD IN CONTACT AREA AND 1.88um/75uin MIN. MATTE TIN IN SOLDER TAIL AREA OVER 1.27um/50uin MIN. NICKEL OVERALL.
- 0.76um/30uin GOLD IN CONTACT AREA AND 1.88um/75uin MIN. MATTE TIN IN SOLDER TAIL AREA OVER 1.27um/50uin MIN. NICKEL OVERALL.
- 2.50um/100uin MIN. MATTE TIN OVER 1.25um/50uin MIN. NICKEL OVERALL.

RELEASED EC NO: S2015-1188 DRWNG:GMENARLY 2015/04/15 CHKD:CGOH 2015/06/29 APPR:KHLIM 2015/06/29	DESCRIPTION	QUALITY SYMBOLS	GENERAL TOLERANCES (UNLESS SPECIFIED)	DIMENSION STYLE	SCALE	DESIGN UNITS	THIRD ANGLE PROJECTION	
		$F_A=0$ $F_G=0$ $F_P=0$	mm    INCH 4 PLACES ± --- ± --- 3 PLACES ± --- ± --- 2 PLACES ± 0.20 ± --- 1 PLACE ± --- ± --- 0 PLACE ± --- ± ---	MM ONLY	NTS	METRIC	DRAWN BY: GMENARLY DATE: 2015/04/15 CHECKED BY: _____ DATE: _____ APPROVED BY: KHLIM DATE: 2015/06/29	TITLE: MILLIGRID 2MM PITCH, THROUGH HOLE VERTICAL SHROUDED HEADER <b>molex</b> DOCUMENT NO. SD-87831-0001
		ANGULAR ± 3 ° DRAFT WHERE APPLICABLE MUST REMAIN WITHIN DIMENSIONS	SEE TABLE	MATERIAL NO. _____ SHEET NO. 12 OF 13				
		THIS DRAWING CONTAINS INFORMATION THAT IS PROPRIETARY TO MOLEX INCORPORATED AND SHOULD NOT BE USED WITHOUT WRITTEN PERMISSION						

42 TO 50 CIRCUITS

CKT SIZE	ASSY P/N WITHOUT CAP IN TUBE	ASSY P/N WITH CAP IN TUBE	ASSY P/N WITH CAP IN T&R	PLATING OPTIONS	FRICTION LOCKS		SIDE SLOTS		CENTER POLARIZATION	PEG	DIMENSION														
					DUAL	CENTER	DUAL	SINGLE			A	B	C	D	E	F	G	H							
42	87831-4219	N.A	N.A	1	YES	N.A	YES	N.A	YES	N.A	40.00	42.85	44.65	43.00	36.00	N.A	2.50	3.60±0.20							
	87831-4220	N.A	N.A	2																					
	87831-4221	N.A	N.A	3																					
	87831-4236	N.A	N.A	4																					
	87831-4228	N.A	N.A	2																					
87831-4229	N.A	N.A	3	YES	N.A	YES	N.A	YES	YES	2.50															
44	87831-4419	N.A	N.A	1	YES	N.A	YES	N.A	YES	N.A	42.00	44.85	46.65	45.00	38.00	N.A	2.50	3.60±0.20							
	87831-4420	N.A	N.A	2																					
	87831-4421	N.A	N.A	3																					
	87831-4436	N.A	N.A	4																					
	87831-4428	N.A	N.A	2																					
	87831-4429	N.A	N.A	3															YES	N.A	YES	N.A	YES	YES	2.50
87831-4435	N.A	N.A	3	YES	N.A	YES	N.A	YES	YES	3.50															
46	87831-4619	N.A	N.A	1	YES	N.A	YES	N.A	YES	N.A	44.00	46.85	48.65	47.00	40.00	N.A	2.50	3.60±0.20							
	87831-4620	N.A	N.A	2																					
	87831-4621	N.A	N.A	3																					
	87831-4636	N.A	N.A	4																					
	87831-4628	N.A	N.A	2																					
	87831-4629	N.A	N.A	3															YES	N.A	YES	N.A	YES	YES	2.50
48	87831-4819	N.A	N.A	1	YES	N.A	YES	N.A	YES	N.A	46.00	48.85	50.65	49.00	42.00	N.A	2.50	3.60±0.20							
	87831-4820	N.A	N.A	2																					
	87831-4821	N.A	N.A	3																					
	87831-4836	N.A	N.A	4																					
	87831-4828	N.A	N.A	2																					
	87831-4829	N.A	N.A	3															YES	N.A	YES	N.A	YES	YES	2.50
50	87831-5019	N.A	N.A	1	YES	N.A	YES	N.A	YES	N.A	48.00	50.85	52.65	51.00	44.00	N.A	2.50	3.60±0.20							
	87831-5020	N.A	N.A	2																					
	87831-5021	N.A	N.A	3																					
	87831-5036	N.A	N.A	4																					
	87831-5028	N.A	N.A	2																					
	87831-5029	N.A	N.A	3															YES	N.A	YES	N.A	YES	YES	2.50
	87831-5035	N.A	N.A	3															YES	N.A	YES	N.A	YES	YES	3.50

PLATING OPTIONS:

- 1 - 0.05-0.13um/2-5uin GOLD IN CONTACT AREA AND 1.88um/75uin MIN. MATTE TIN IN SOLDER TAIL AREA OVER 1.27um/50uin MIN. NICKEL OVERALL.
- 2 - 0.38um/15uin GOLD IN CONTACT AREA AND 1.88um/75uin MIN. MATTE TIN IN SOLDER TAIL AREA OVER 1.27um/50uin MIN. NICKEL OVERALL.
- 3 - 0.76um/30uin GOLD IN CONTACT AREA AND 1.88um/75uin MIN. MATTE TIN IN SOLDER TAIL AREA OVER 1.27um/50uin MIN. NICKEL OVERALL.
- 4 - 2.50um/100uin MIN. MATTE TIN OVER 1.25um/50uin MIN. NICKEL OVERALL.

RELEASED IEC NO: S2015-1188 DRWNG:GMENARLY 2015/04/15 CHK'D:CGOH 2015/06/29 APPR:KHLIM 2015/06/29	DESCRIPTION QUALITY SYMBOLS $\nabla_F = 0$ $\nabla_E = 0$ $\nabla_D = 0$	GENERAL TOLERANCES (UNLESS SPECIFIED)		DIMENSION STYLE		SCALE	DESIGN UNITS	THIRD ANGLE PROJECTION			
				MM ONLY		NTS	METRIC				
				mm	INCH	DRAWN BY DATE		TITLE			
						GMENARLY 2015/04/15		MILLIGRID 2MM PITCH, THROUGH HOLE VERTICAL SHROUDED HEADER			
				CHECKED BY DATE		molex					
				APPROVED BY DATE		DOCUMENT NO.					
				KHLIM 2015/06/29		SD-87831-0001					
				MATERIAL NO.		SHEET NO.					
				SEE TABLE		13 OF 13					
				ANGULAR ± 3 °		THIS DRAWING CONTAINS INFORMATION THAT IS PROPRIETARY TO MOLEX INCORPORATED AND SHOULD NOT BE USED WITHOUT WRITTEN PERMISSION					
				DRAFT WHERE APPLICABLE MUST REMAIN WITHIN DIMENSIONS							

Компания «Life Electronics» занимается поставками электронных компонентов импортного и отечественного производства от производителей и со складов крупных дистрибьюторов Европы, Америки и Азии.

С конца 2013 года компания активно расширяет линейку поставок компонентов по направлению коаксиальный кабель, кварцевые генераторы и конденсаторы (керамические, пленочные, электролитические), за счёт заключения дистрибьюторских договоров

Мы предлагаем:

- Конкурентоспособные цены и скидки постоянным клиентам.
- Специальные условия для постоянных клиентов.
- Подбор аналогов.
- Поставку компонентов в любых объемах, удовлетворяющих вашим потребностям.
- Приемлемые сроки поставки, возможна ускоренная поставка.
- Доставку товара в любую точку России и стран СНГ.
- Комплексную поставку.
- Работу по проектам и поставку образцов.
- Формирование склада под заказчика.
- Сертификаты соответствия на поставляемую продукцию (по желанию клиента).
- Тестирование поставляемой продукции.
- Поставку компонентов, требующих военную и космическую приемку.
- Входной контроль качества.
- Наличие сертификата ISO.

В составе нашей компании организован Конструкторский отдел, призванный помогать разработчикам, и инженерам.

Конструкторский отдел помогает осуществить:

- Регистрацию проекта у производителя компонентов.
- Техническую поддержку проекта.
- Защиту от снятия компонента с производства.
- Оценку стоимости проекта по компонентам.
- Изготовление тестовой платы монтаж и пусконаладочные работы.



Тел: +7 (812) 336 43 04 (многоканальный)

Email: [org@lifeelectronics.ru](mailto:org@lifeelectronics.ru)