



Is Now Part of



**ON Semiconductor®**

To learn more about ON Semiconductor, please visit our website at  
[www.onsemi.com](http://www.onsemi.com)

Please note: As part of the Fairchild Semiconductor integration, some of the Fairchild orderable part numbers will need to change in order to meet ON Semiconductor's system requirements. Since the ON Semiconductor product management systems do not have the ability to manage part nomenclature that utilizes an underscore (\_), the underscore (\_) in the Fairchild part numbers will be changed to a dash (-). This document may contain device numbers with an underscore (\_). Please check the ON Semiconductor website to verify the updated device numbers. The most current and up-to-date ordering information can be found at [www.onsemi.com](http://www.onsemi.com). Please email any questions regarding the system integration to [Fairchild\\_questions@onsemi.com](mailto:Fairchild_questions@onsemi.com).

ON Semiconductor and the ON Semiconductor logo are trademarks of Semiconductor Components Industries, LLC dba ON Semiconductor or its subsidiaries in the United States and/or other countries. ON Semiconductor owns the rights to a number of patents, trademarks, copyrights, trade secrets, and other intellectual property. A listing of ON Semiconductor's product/patent coverage may be accessed at [www.onsemi.com/site/pdf/Patent-Marking.pdf](http://www.onsemi.com/site/pdf/Patent-Marking.pdf). ON Semiconductor reserves the right to make changes without further notice to any products herein. ON Semiconductor makes no warranty, representation or guarantee regarding the suitability of its products for any particular purpose, nor does ON Semiconductor assume any liability arising out of the application or use of any product or circuit, and specifically disclaims any and all liability, including without limitation special, consequential or incidental damages. Buyer is responsible for its products and applications using ON Semiconductor products, including compliance with all laws, regulations and safety requirements or standards, regardless of any support or applications information provided by ON Semiconductor. "Typical" parameters which may be provided in ON Semiconductor data sheets and/or specifications can and do vary in different applications and actual performance may vary over time. All operating parameters, including "Typicals" must be validated for each customer application by customer's technical experts. ON Semiconductor does not convey any license under its patent rights nor the rights of others. ON Semiconductor products are not designed, intended, or authorized for use as a critical component in life support systems or any FDA Class 3 medical devices or medical devices with a same or similar classification in a foreign jurisdiction or any devices intended for implantation in the human body. Should Buyer purchase or use ON Semiconductor products for any such unintended or unauthorized application, Buyer shall indemnify and hold ON Semiconductor and its officers, employees, subsidiaries, affiliates, and distributors harmless against all claims, costs, damages, and expenses, and reasonable attorney fees arising out of, directly or indirectly, any claim of personal injury or death associated with such unintended or unauthorized use, even if such claim alleges that ON Semiconductor was negligent regarding the design or manufacture of the part. ON Semiconductor is an Equal Opportunity/Affirmative Action Employer. This literature is subject to all applicable copyright laws and is not for resale in any manner.

# HCPL3700

## AC/DC to Logic Interface Optocoupler

### Features

- AC or DC input
- Programmable sense voltage
- Logic level compatibility
- Threshold guaranteed over temperature (0°C to 70°C)
- Optoplanar™ construction for high common mode immunity
- UL recognized (file # E90700)
- VDE certified – ordering option 'V', e.g., HCPL3700V

### Applications

- Low voltage detection
- 5 V to 240 V AC/DC voltage sensing
- Relay contact monitor
- Current sensing
- Microprocessor Interface
- Industrial controls

### Description

The HCPL-3700 voltage/current threshold detection optocoupler consists of an AlGaAs LED connected to a threshold sensing input buffer IC which are optically coupled to a high gain darlington output. The input buffer chip is capable of controlling threshold levels over a wide range of input voltages with a single resistor. The output is TTL and CMOS compatible.

### Schematics

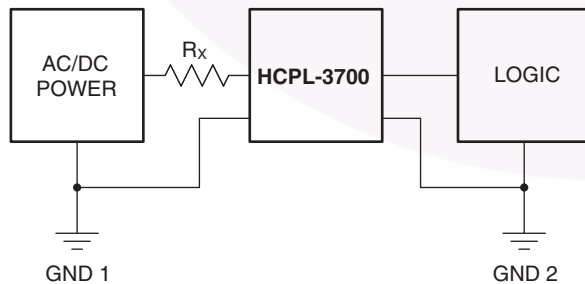
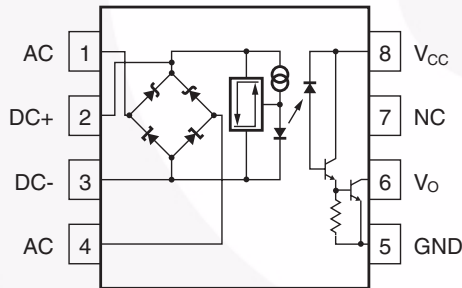

### Package Outlines



**TRUTH TABLE**  
(Positive Logic)

Input	Output
H	L
L	H

A 0.1µF bypass capacitor must be connected between pins 8 and 5.

### Absolute Maximum Ratings (No derating required up to 70°C)

Stresses exceeding the absolute maximum ratings may damage the device. The device may not function or be operable above the recommended operating conditions and stressing the parts to these levels is not recommended. In addition, extended exposure to stresses above the recommended operating conditions may affect device reliability. The absolute maximum ratings are stress ratings only.

Symbol	Parameter		Value	Units
T <sub>STG</sub>	Storage Temperature		-55 to +125	°C
T <sub>OPR</sub>	Operating Temperature		-40 to +85	°C
T <sub>SOL</sub>	Lead Solder Temperature		260 for 10 sec	°C
<b>EMITTER</b>				
I <sub>IN</sub>	Input Current	Average	50 (Max.)	mA
		Surge, 3ms, 120Hz Pulse Rate	140 (Max.)	
		Transient, 10µs, 120Hz Pulse Rate	500 (Max.)	
V <sub>IN</sub>	Input Voltage (Pins 2-3)		-0.5 (Max.)	V
P <sub>IN</sub>	Input Power Dissipation <sup>(1)</sup>		230 (Max.)	mW
P <sub>T</sub>	Total Package Power Dissipation <sup>(2)</sup>		305 (Max.)	mW
<b>DETECTOR</b>				
I <sub>O</sub>	Output Current (Average) <sup>(3)</sup>		30 (Max.)	mA
V <sub>CC</sub>	Supply Voltage (Pins 8-5)		-0.5 to 20	V
V <sub>O</sub>	Output Voltage (Pins 6-5)		-0.5 to 20	V
P <sub>O</sub>	Output Power Dissipation <sup>(4)</sup>		210 (Max.)	mW

**Notes:**

1. Derate linearly above 70°C free-air temperature at a rate of 1.8 mW/°C.
2. Derate linearly above 70°C free-air temperature at a rate of 2.5 mW/°C.
3. Derate linearly above 70°C free-air temperature at a rate of 0.6 mA/°C.
4. Derate linearly above 70°C free-air temperature at a rate of 1.9 mW/°C.

### Recommended Operating Conditions

The Recommended Operating Conditions table defines the conditions for actual device operation. Recommended operating conditions are specified to ensure optimal performance to the datasheet specifications. Fairchild does not recommend exceeding them or designing to absolute maximum ratings.

Symbol	Parameter	Min.	Max.	Units
V <sub>CC</sub>	Supply Voltage	2	18	V
T <sub>A</sub>	Operating Temperature	0	70	°C
f	Operating Frequency	0	4	kHz

**Electrical Characteristics** ( $T_A = 0^\circ\text{C}$  to  $70^\circ\text{C}$  Unless otherwise specified)

Symbol	Parameter		Test Conditions	Min.	Typ.	Max.	Unit
$I_{TH+}$	Input Threshold Current		$V_{IN} = V_{TH+}$ , $V_{CC} = 4.5\text{ V}$	1.96	2.4	3.11	mA
$I_{TH-}$			$V_O = 0.4\text{ V}$ , $I_O \geq 4.2\text{ mA}^{(5)}$	1.00	1.2	1.62	mA
$V_{TH+}$	Input Threshold Voltage	DC (Pins 2,3)	$V_{IN} = V_2 - V_3$ (Pins 1 & 4 Open) $V_{CC} = 4.5\text{ V}$ , $V_O = 0.4\text{ V}^{(5)}$ $I_O \geq 4.2\text{ mA}$	3.35	3.8	4.05	V
$V_{TH-}$			$V_{IN} = V_2 - V_3$ (Pins 1 & 4 Open) $V_{CC} = 4.5\text{ V}$ , $V_O = 2.4\text{ V}^{(5)}$ $I_O \geq 100\mu\text{A}$	2.01	2.5	2.86	V
$V_{TH+}$		AC (Pins 1,4)	$ V_{IN} = V_1 - V_4 $ (Pins 2 & 3 Open) $V_{CC} = 4.5\text{ V}$ , $V_O = 0.4\text{ V}^{(5)}$ $I_O \geq 4.2\text{ mA}$	4.23	5.0	5.50	V
$V_{TH-}$			$ V_{IN} =  V_1 - V_4  $ (Pins 2 & 3 Open) $V_{CC} = 4.5\text{ V}$ , $V_O = 2.4\text{ V}^{(5)}$ $I_O \leq 100\mu\text{A}$	2.87	3.7	4.20	V
$I_{HYS}$	Hysteresis		$I_{HYS} = I_{TH+} - I_{TH-}$		1.2		mA
$V_{HYS}$			$V_{HYS} = V_{TH+} - V_{TH-}$		1.3		V
$V_{IHC1}$	Input Clamp Voltage		$V_{IHC1} = V_2 - V_3$ , $V_3 = \text{GND}$ $I_{IN} = 10\text{ mA}$ , Pins 1 & 4 connected to Pin 3	5.4	6.3	6.6	V
$V_{IHC2}$			$V_{IHC2} =  V_1 - V_4 $ , $ I_{IN}  = 10\text{ mA}$ (Pins 2 & 3 Open)	6.1	7.0	7.3	V
$V_{IHC3}$			$V_{IHC3} = V_2 - V_3$ , $V_3 = \text{GND}$ , $I_{IN} = 15\text{ mA}$ (Pins 1 & 4 Open)		12.5	13.4	V
$V_{ILC}$			$V_{ILC} = V_2 - V_3$ , $V_3 = \text{GND}$ , $I_{IN} = -10\text{ mA}$		-0.75		V
$I_{IN}$	Input Current		$V_{IN} = V_2 - V_3 = 5.0\text{ V}$ (Pins 1 & 4 Open)	3.0	3.7	4.4	mA
$V_{D1,2}$	Bridge Diode Forward Voltage		$I_{IN} = 3\text{ mA}$		0.65		V
$V_{D3,4}$			$I_{IN} = 3\text{ mA}$		0.65		V
$V_{OL}$	Logic LOW Output Voltage		$V_{CC} = 4.5\text{ V}$ , $I_{OL} = 4.2\text{ mA}^{(5)}$		0.04	0.4	V
$I_{OH}$	Logic HIGH Output Current		$V_{OH} = V_{CC} = 18\text{ V}^{(5)}$			100	$\mu\text{A}$
$I_{CCL}$	Logic LOW Supply Current		$V_2 - V_3 = 5.0\text{ V}$ , $V_O = \text{Open}$ , $V_{CC} = 5\text{ V}$		1.0	4	mA
$I_{CCH}$	Logic HIGH Supply Current		$V_{CC} = 18\text{ V}$ , $V_O = \text{Open}$		0.01	4	$\mu\text{A}$
$C_{IN}$	Input Capacitance		$f = 1\text{ MHz}$ , $V_{IN} = 0\text{ V}$ (Pins 2 & 3, Pins 1 & 4 Open)		50		pF

**Note:**

5. Logic LOW output level at pin 6 occurs when  $V_{IN} \geq V_{TH+}$  and when  $V_{IN} > V_{TH-}$  once  $V_{IN}$  exceeds  $V_{TH+}$ .  
 Logic HIGH output level at pin 6 occurs when  $V_{IN} \leq V_{TH-}$  and when  $V_{IN} < V_{TH+}$  once  $V_{IN}$  decreases below  $V_{TH-}$ .

**Switching Characteristics** ( $T_A = 25^\circ\text{C}$ ,  $V_{CC} = 5\text{ V}$  Unless otherwise specified)

Symbol	AC Characteristics	Test Conditions	Min.	Typ.	Max.	Unit
$T_{PHL}$	Propagation Delay Time (to Output Low Level)	$R_L = 4.7\text{k}\Omega$ , $C_L = 30\text{pF}^{(6)}$		6.0	15	$\mu\text{s}$
$T_{PLH}$	Propagation Delay Time (to Output High Level)	$R_L = 4.7\text{k}\Omega$ , $C_L = 30\text{pF}^{(6)}$		25.0	40	$\mu\text{s}$
$t_r$	Output Rise Time (10–90%)	$R_L = 4.7\text{k}\Omega$ , $C_L = 30\text{pF}$		45		$\mu\text{s}$
$t_f$	Output Fall Time (90–10%)	$R_L = 4.7\text{k}\Omega$ , $C_L = 30\text{pF}$		0.5		$\mu\text{s}$
$ICM_{HI}$	Common Mode Transient Immunity (at Output High Level)	$I_{IN} = 0\text{ mA}$ , $R_L = 4.7\text{k}\Omega$ , $V_{O\text{ min}} = 2.0\text{ V}$ , $V_{CM} = 1400\text{V}^{(7)(8)}$		4000		$\text{V}/\mu\text{s}$
$ICM_{LI}$	Common Mode Transient Immunity (at Output Low Level)	$I_N = 3.11\text{mA}$ , $R_L = 4.7\text{k}\Omega$ , $V_{O\text{ max}} = 0.8\text{V}$ , $V_{CM} = 140\text{V}^{(7)(8)}$		600		$\text{V}/\mu\text{s}$

**Package Characteristics** ( $T_A = 0^\circ\text{C}$  to  $70^\circ\text{C}$  Unless otherwise specified)

Symbol	Characteristics	Test Conditions	Min.	Typ.	Max.	Unit
$V_{ISO}$	Withstand Insulation Voltage	Relative humidity < 50%, $T_A = 25^\circ\text{C}$ , $t = 1\text{ min}$ , $I_{I-O} \leq 2\mu\text{A}^{(9)(10)}$	2500			$V_{RMS}$
$R_{I-O}$	Resistance (input to output)	$V_{IO} = 500\text{Vdc}^{(9)}$		$10^{12}$		$\Omega$
$C_{I-O}$	Capacitance (input to output)	$f = 1\text{MHz}$ , $V_{IO} = 0\text{Vdc}$		0.6		$\text{pF}$

**Notes:**

- $T_{PHL}$  propagation delay is measured from the 2.5V level of the leading edge of a 5.0V input pulse (1 $\mu\text{s}$  rise time) to the 1.5 V level on the leading edge of the output pulse.  $T_{PLH}$  propagation delay is measured on the trailing edges of the input and output pulse. (Refer to Fig. 9)
- Common mode transient immunity in logic high level is the maximum tolerable (positive)  $dV_{cm}/dt$  on the leading edge of the common mode pulse signal  $V_{CM}$ , to assure that the output will remain in a logic high state (i.e.,  $V_O > 2.0\text{ V}$ ). Common mode transient immunity in logic low level is the maximum tolerable (negative)  $dV_{cm}/dt$  on the trailing edge of the common mode pulse signal,  $V_{CM}$ , to assure that the output will remain in a logic low state (i.e.,  $V_O < 0.8\text{ V}$ ). Refer to Fig. 10.
- In applications where  $dV_{cm}/dt$  may exceed 50,000  $\text{V}/\mu\text{s}$  (Such as static discharge), a series resistor,  $R_{CC}$ , should be included to protect the detector chip from destructive surge currents. The recommended value for  $R_{CC}$  is 240V per volt of allowable drop in  $V_{CC}$  (between pin 8 and  $V_{CC}$ ) with a minimum value of 240 $\Omega$ .
- Device is considered a two terminal device: Pins 1, 2, 3 and 4 are shorted together and Pins 5, 6, 7 and 8 are shorted together.
- The 2500  $V_{RMS}/1\text{ min.}$  capability is validated by a 3.0  $\text{kV}_{RMS}/1\text{ sec.}$  dielectric voltage withstand test.
- AC voltage is instantaneous voltage for  $V_{TH+}$  &  $V_{TH-}$ .
- All typicals at  $T_A = 25^\circ\text{C}$ ,  $V_{CC} = 5\text{V}$  unless otherwise specified.

## Typical Performance Curves

**Fig. 1 Logic Low Supply Current vs. Operating Supply Voltage**

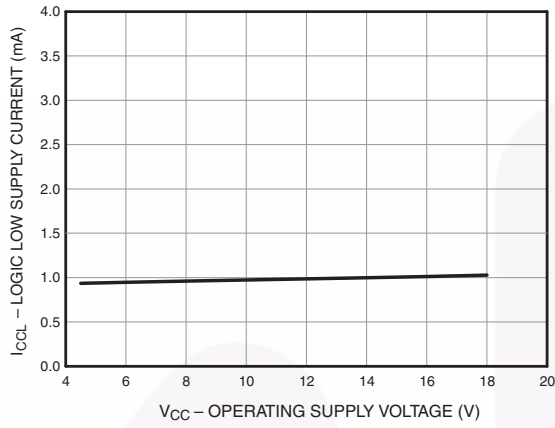

**Fig. 2 Input Current vs. Input Voltage**

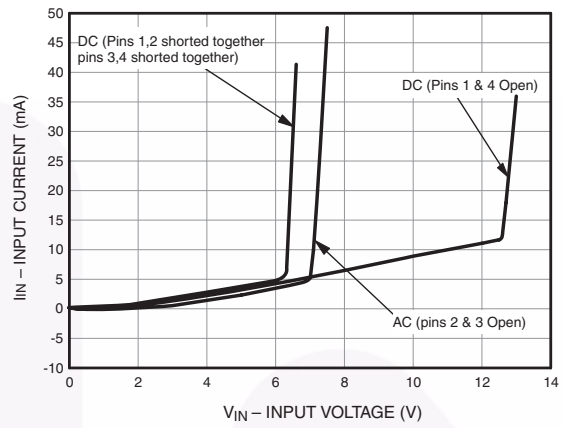

**Fig. 3 Input Current/Low Level Output Voltage vs. Temperature**



**Fig. 4 Current Threshold/Voltage Threshold vs. Temperature**



**Fig. 5 Propagation Delay vs. Temperature**



**Fig. 6 Rise and Fall Time vs. Temperature**



Typical Performance Curves (Continued)

Fig. 7 Logic High Supply Current vs. Temperature

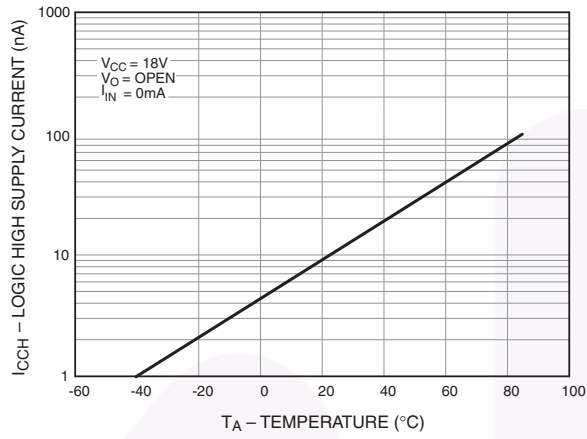
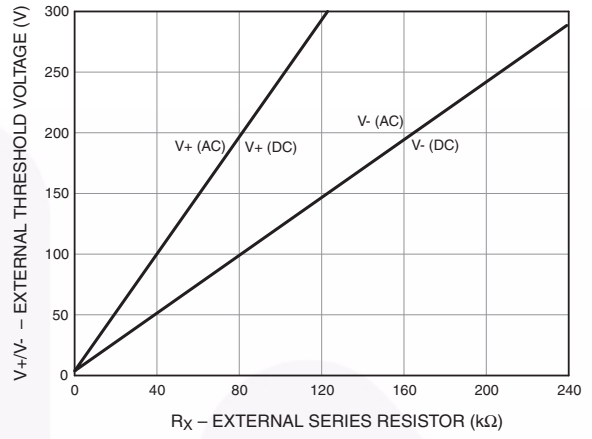

Fig. 8 External Threshold Characteristics V+/V- vs. R<sub>x</sub>



Test Circuits



$V_{IN}$   
 Pulse Amplitude = 50V  
 Pulse Width = 1ms  
 $f = 100\text{Hz}$   
 $T_r = T_f = 1.0\mu\text{s}$  (10%–90%)

Fig. 9. Switching Test Circuit

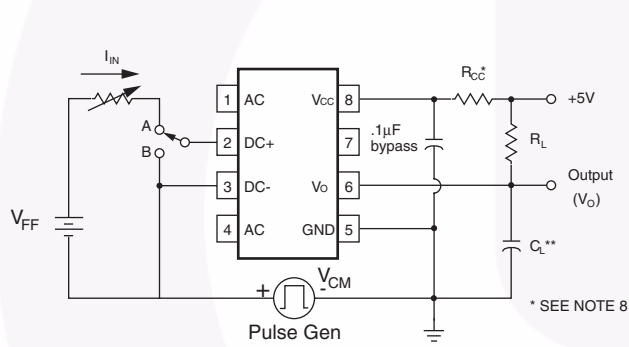

Fig. 10. Test Circuit for Common Mode Transient Immunity and Typical Waveforms



## Ordering Information

Option	Example Part Number	Description
No Suffix	HCPL3700	Shipped in Tubes
S	HCPL3700S	Surface Mount Lead Bend
SD	HCPL3700SD	Surface Mount; Tape and Reel
W	HCPL3700W	0.4" Lead Spacing
V	HCPL3700V	VDE0884
WV	HCPL3700WV	VDE0884; 0.4" Lead Spacing
SV	HCPL3700SV	VDE0884; Surface Mount
SDV	HCPL3700SDV	VDE0884; Surface Mount; Tape and Reel

## Marking Information



Definitions	
1	Fairchild logo
2	Device number
3	VDE mark (Note: Only appears on parts ordered with VDE option – See order entry table)
4	Two digit year code, e.g., '07'
5	Two digit work week ranging from '01' to '53'
6	Assembly package code

### Carrier Tape Specifications



**Note:**  
All dimensions are in inches (millimeters)

### Reflow Profile



- Peak reflow temperature: 225C (package surface temperature)
- Time of temperature higher than 183C for 60–150 seconds
- One time soldering reflow is recommended



- NOTES:  
 A) NO STANDARD APPLIES TO THIS PACKAGE  
 B) ALL DIMENSIONS ARE IN MILLIMETERS.  
 C) DIMENSIONS ARE EXCLUSIVE OF BURRS, MOLD FLASH, AND TIE BAR EXTRUSION  
 D) DRAWING FILENAME AND REVISION: MKT-N08GREV7





LAND PATTERN RECOMMENDATION



NOTES:

- A) NO STANDARD APPLIES TO THIS PACKAGE
- B) ALL DIMENSIONS ARE IN MILLIMETERS.
- C) DIMENSIONS ARE EXCLUSIVE OF BURRS, MOLD FLASH, AND TIE BAR EXTRUSION
- D) DRAWING FILENAME AND REVISION: MKT-N08Hrev7.



ON Semiconductor and  are trademarks of Semiconductor Components Industries, LLC dba ON Semiconductor or its subsidiaries in the United States and/or other countries. ON Semiconductor owns the rights to a number of patents, trademarks, copyrights, trade secrets, and other intellectual property. A listing of ON Semiconductor's product/patent coverage may be accessed at [www.onsemi.com/site/pdf/Patent-Marking.pdf](http://www.onsemi.com/site/pdf/Patent-Marking.pdf). ON Semiconductor reserves the right to make changes without further notice to any products herein. ON Semiconductor makes no warranty, representation or guarantee regarding the suitability of its products for any particular purpose, nor does ON Semiconductor assume any liability arising out of the application or use of any product or circuit, and specifically disclaims any and all liability, including without limitation special, consequential or incidental damages. Buyer is responsible for its products and applications using ON Semiconductor products, including compliance with all laws, regulations and safety requirements or standards, regardless of any support or applications information provided by ON Semiconductor. "Typical" parameters which may be provided in ON Semiconductor data sheets and/or specifications can and do vary in different applications and actual performance may vary over time. All operating parameters, including "Typicals" must be validated for each customer application by customer's technical experts. ON Semiconductor does not convey any license under its patent rights nor the rights of others. ON Semiconductor products are not designed, intended, or authorized for use as a critical component in life support systems or any FDA Class 3 medical devices or medical devices with a same or similar classification in a foreign jurisdiction or any devices intended for implantation in the human body. Should Buyer purchase or use ON Semiconductor products for any such unintended or unauthorized application, Buyer shall indemnify and hold ON Semiconductor and its officers, employees, subsidiaries, affiliates, and distributors harmless against all claims, costs, damages, and expenses, and reasonable attorney fees arising out of, directly or indirectly, any claim of personal injury or death associated with such unintended or unauthorized use, even if such claim alleges that ON Semiconductor was negligent regarding the design or manufacture of the part. ON Semiconductor is an Equal Opportunity/Affirmative Action Employer. This literature is subject to all applicable copyright laws and is not for resale in any manner.

## PUBLICATION ORDERING INFORMATION

### LITERATURE FULFILLMENT:

Literature Distribution Center for ON Semiconductor  
19521 E. 32nd Pkwy, Aurora, Colorado 80011 USA  
**Phone:** 303-675-2175 or 800-344-3860 Toll Free USA/Canada  
**Fax:** 303-675-2176 or 800-344-3867 Toll Free USA/Canada  
**Email:** [orderlit@onsemi.com](mailto:orderlit@onsemi.com)

**N. American Technical Support:** 800-282-9855 Toll Free  
USA/Canada  
**Europe, Middle East and Africa Technical Support:**  
Phone: 421 33 790 2910  
**Japan Customer Focus Center**  
Phone: 81-3-5817-1050

**ON Semiconductor Website:** [www.onsemi.com](http://www.onsemi.com)  
**Order Literature:** <http://www.onsemi.com/orderlit>  
For additional information, please contact your local  
Sales Representative

# Mouser Electronics

Authorized Distributor

Click to View Pricing, Inventory, Delivery & Lifecycle Information:

[ON Semiconductor:](#)

[HCPL3700S](#) [HCPL3700V](#) [HCPL3700](#) [HCPL3700SDV](#) [HCPL3700SV](#) [HCPL3700SD](#) [HCPL3700WV](#)

Компания «Life Electronics» занимается поставками электронных компонентов импортного и отечественного производства от производителей и со складов крупных дистрибьюторов Европы, Америки и Азии.

С конца 2013 года компания активно расширяет линейку поставок компонентов по направлению коаксиальный кабель, кварцевые генераторы и конденсаторы (керамические, пленочные, электролитические), за счёт заключения дистрибьюторских договоров

Мы предлагаем:

- Конкурентоспособные цены и скидки постоянным клиентам.
- Специальные условия для постоянных клиентов.
- Подбор аналогов.
- Поставку компонентов в любых объемах, удовлетворяющих вашим потребностям.
- Приемлемые сроки поставки, возможна ускоренная поставка.
- Доставку товара в любую точку России и стран СНГ.
- Комплексную поставку.
- Работу по проектам и поставку образцов.
- Формирование склада под заказчика.
- Сертификаты соответствия на поставляемую продукцию (по желанию клиента).
- Тестирование поставляемой продукции.
- Поставку компонентов, требующих военную и космическую приемку.
- Входной контроль качества.
- Наличие сертификата ISO.

В составе нашей компании организован Конструкторский отдел, призванный помогать разработчикам, и инженерам.

Конструкторский отдел помогает осуществить:

- Регистрацию проекта у производителя компонентов.
- Техническую поддержку проекта.
- Защиту от снятия компонента с производства.
- Оценку стоимости проекта по компонентам.
- Изготовление тестовой платы монтаж и пусконаладочные работы.



Тел: +7 (812) 336 43 04 (многоканальный)  
Email: [org@lifeelectronics.ru](mailto:org@lifeelectronics.ru)