

## I/O module - AXL F DO16 FLK 1H - 2701813

Please be informed that the data shown in this PDF Document is generated from our Online Catalog. Please find the complete data in the user's documentation. Our General Terms of Use for Downloads are valid (<http://phoenixcontact.com/download>)



Axioline F digital output module, 16 outputs, 24 V DC, 500 mA, FLK20 connection for system cabling (including bus base module and connectors)

### Product Description

The module is designed for use within an Axioline F station. It is used to output digital signals. You can connect PLC relays from the INTERFACE product range quickly and conveniently using the FLK connection. This means that you can also use this output module in applications which require relays, e.g., to switch high voltages or currents.

### Product Features

- 16 digital outputs
- 24 V DC, 500 mA
- 
- Minimum update time of < 100  $\mu$ s
- Device rating plate stored
- Diagnostic and status indicators



### Key Commercial Data

Packing unit	1 pc
Weight per Piece (excluding packing)	200.0 g
Custom tariff number	85389091
Country of origin	Germany

### Technical data

#### Note

Utilization restriction	EMC: class A product, see manufacturer's declaration in the download area
-------------------------	---

#### Dimensions

Width	35 mm
Height	126.1 mm

# I/O module - AXL F DO16 FLK 1H - 2701813

## Technical data

### Dimensions

Depth	54 mm
Note on dimensions	The depth is valid when a TH 35-7.5 DIN rail is used (according to EN 60715).

### Ambient conditions

Ambient temperature (operation)	-25 °C ... 60 °C
Ambient temperature (storage/transport)	-40 °C ... 85 °C
Permissible humidity (operation)	5 % ... 95 % (non-condensing)
Permissible humidity (storage/transport)	5 % ... 95 % (non-condensing)
Air pressure (operation)	70 kPa ... 106 kPa (up to 3000 m above sea level)
Air pressure (storage/transport)	70 kPa ... 106 kPa (up to 3000 m above sea level)
Degree of protection	IP20

### Connection data

Designation	Axioline F connector
Connection method	Push-in connection
Note on connection method	Please observe the information provided on conductor cross sections in the "Axioline F: system and installation" user manual.
Conductor cross section solid min.	0.2 mm <sup>2</sup>
Conductor cross section solid max.	1.5 mm <sup>2</sup>
Conductor cross section flexible min.	0.2 mm <sup>2</sup>
Conductor cross section flexible max.	1.5 mm <sup>2</sup>
Conductor cross section AWG min.	24
Conductor cross section AWG max.	16
Stripping length	8 mm

### General

Net weight	108 g
Note on weight specifications	with connector and bus base module
Mounting type	DIN rail
Protection class	III, IEC 61140, EN 61140, VDE 0140-1
Test section	5 V communications power (logic), 24 V supply (I/O) 500 V AC 50 Hz 1 min
	5 V supply (logic)/functional earth ground 500 V AC 50 Hz 1 min
	24 V supply (I/O) / functional earth ground 500 V AC 50 Hz 1 min
Conformance with EMC directives	Noise immunity test in accordance with EN 61000-6-2 Electrostatic discharge (ESD) EN 61000-4-2/IEC 61000-4-2 Criterion B; 6 kV contact discharge, 8 kV air discharge
	Noise immunity test in accordance with EN 61000-6-2 Electromagnetic fields EN 61000-4-3/IEC 61000-4-3 Criterion A; Field intensity: 10 V/m
	Noise immunity test in accordance with EN 61000-6-2 Fast transients (burst) EN 61000-4-4/IEC 61000-4-4 Criterion B, 2 kV

# I/O module - AXL F DO16 FLK 1H - 2701813

## Technical data

### General

	Noise immunity test in accordance with EN 61000-6-2 Transient surge voltage (surge) EN 61000-4-5/IEC 61000-4-5 Criterion B; DC supply lines: $\pm 0.5$ kV/ $\pm 0.5$ kV (symmetrical/asymmetrical)
	Noise immunity test in accordance with EN 61000-6-2 Conducted interference EN 61000-4-6/IEC 61000-4-6 Criterion A; Test voltage 10 V
	Noise emission test according to EN 61000-6-3 Radio interference properties EN 55022 Class B
Mechanical tests	Vibration resistance in acc. with EN 60068-2-6/IEC 60068-2-6 5g
	Shock in acc. with EN 60068-2-27/IEC 60068-2-27 30g, 11 ms period, half-sine shock pulse
	Continuous shock according to EN 60068-2-27/IEC 60068-2-27 10g
Diagnostics messages	Short-circuit / overload of the digital outputs Yes

### Interfaces

Designation	Axioline F local bus
Connection method	Bus base module
Transmission speed	100 MBit/s

### Axioline potentials

Communications power $U_{Bus}$	5 V DC (via bus base module)
Current consumption from $U_{Bus}$	max. 120 mA
Supply of digital output modules $U_O$	24 V DC
Current consumption from $U_O$	8 A (external fuse)

### Digital outputs

Output name	Digital outputs
Connection method	FLK20 pin strip
	FLK connector (20-pos.)
Number of outputs	16
Protective circuit	Short-circuit protection, overload protection of the outputs Electronic
Output voltage	24 V
Nominal output voltage	24 V DC
Maximum output current per channel	500 mA
Maximum output current per module	8 A (external fuse)
Nominal load, inductive	max. 12 VA (1.2 H; 48 $\Omega$ ; with nominal voltage)
Nominal load, lamp	max. 12 W (at nominal voltage)
Nominal load, ohmic	max. 12 W (48 $\Omega$ ; with nominal voltage)

# I/O module - AXL F DO16 FLK 1H - 2701813

## Classifications

### eCl@ss

eCl@ss 4.0	27240404
eCl@ss 4.1	27240404
eCl@ss 5.0	27242204
eCl@ss 5.1	27242604
eCl@ss 6.0	27242604
eCl@ss 7.0	27242604
eCl@ss 8.0	27242604

### ETIM

ETIM 4.0	EC001599
ETIM 5.0	EC001599

### UNSPSC

UNSPSC 6.01	43172015
UNSPSC 7.0901	43201404
UNSPSC 11	39121311
UNSPSC 12.01	39121311
UNSPSC 13.2	39121311

## Approvals

### Approvals

---

Approvals

UL Listed / cUL Listed / cULus Listed

---

Ex Approvals

---

Approvals submitted

---

### Approval details

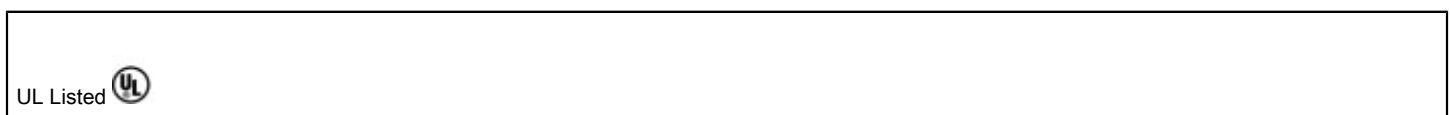

# I/O module - AXL F DO16 FLK 1H - 2701813

## Approvals



## Drawings

Connection diagram

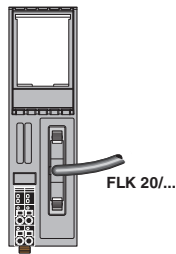

Connection diagram

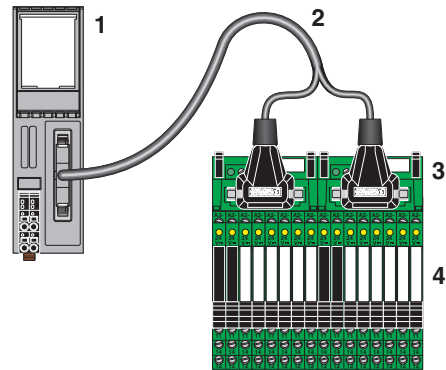

Connection of relay modules

Connection diagram

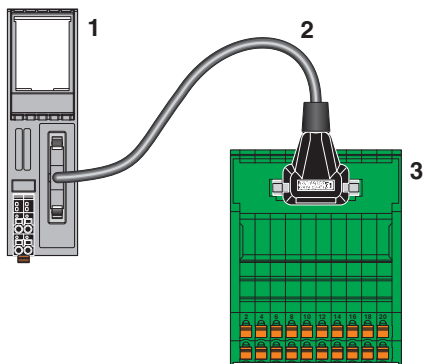

Dimensional drawing

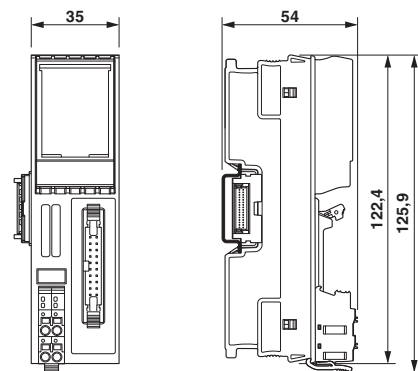

Connection of an interface module

# I/O module - AXL F DO16 FLK 1H - 2701813

Block diagram

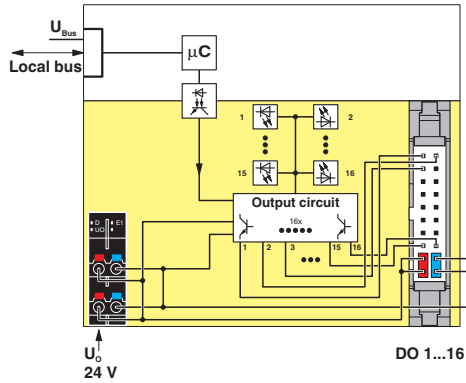

Internal wiring of the terminal points

Diagram

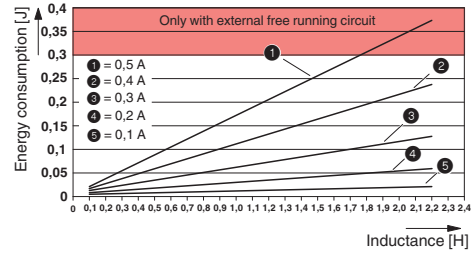

**Maximum energy consumption of the outputs when switching off inductive loads**  
 The diagram shows the maximum amount of energy that may be fed back into the corresponding output groups (outputs 1 to 4, 5 to 8, 9 to 12, 13 to 16) for each switch off procedure when switching off an inductive load without external freewheeling circuit.  
 The current data refers to the ohmic DC voltage component of the inductive load.  
 Note: Restrict freewheeling voltage to a maximum of -15 V when using an external freewheeling circuit. The external freewheeling circuit has no function in the event of a higher negative voltage.

Компания «Life Electronics» занимается поставками электронных компонентов импортного и отечественного производства от производителей и со складов крупных дистрибьюторов Европы, Америки и Азии.

С конца 2013 года компания активно расширяет линейку поставок компонентов по направлению коаксиальный кабель, кварцевые генераторы и конденсаторы (керамические, пленочные, электролитические), за счёт заключения дистрибьюторских договоров

Мы предлагаем:

- Конкуренеспособные цены и скидки постоянным клиентам.
- Специальные условия для постоянных клиентов.
- Подбор аналогов.
- Поставку компонентов в любых объемах, удовлетворяющих вашим потребностям.
- Приемлемые сроки поставки, возможна ускоренная поставка.
- Доставку товара в любую точку России и стран СНГ.
- Комплексную поставку.
- Работу по проектам и поставку образцов.
- Формирование склада под заказчика.
- Сертификаты соответствия на поставляемую продукцию (по желанию клиента).
- Тестирование поставляемой продукции.
- Поставку компонентов, требующих военную и космическую приемку.
- Входной контроль качества.
- Наличие сертификата ISO.

В составе нашей компании организован Конструкторский отдел, призванный помогать разработчикам, и инженерам.

Конструкторский отдел помогает осуществить:

- Регистрацию проекта у производителя компонентов.
- Техническую поддержку проекта.
- Защиту от снятия компонента с производства.
- Оценку стоимости проекта по компонентам.
- Изготовление тестовой платы монтаж и пусконаладочные работы.



Тел: +7 (812) 336 43 04 (многоканальный)  
Email: [org@lifeelectronics.ru](mailto:org@lifeelectronics.ru)