

# LE B P3W 01

## OSRAM OSTAR® Projection Power

OSRAM OSTAR Projection Power is a high luminance LED for projection applications.

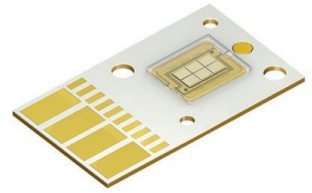

### Applications

- Projection Home LED & Laser
- Projection Professional LED & Laser

### Features:

- Package: OSTAR High Power Projection
- Chip technology: UX:3
- Typ. Radiation: 120° (Lambertian emitter)
- Color:  $\lambda_{\text{dom}} = 459 \text{ nm}$  (● blue)
- Corrosion Robustness Class: 3B
- ESD: 2 kV acc. to ANSI/ESDA/JEDEC JS-001 (HBM, Class 2)

### Ordering Information

Type	Total radiant flux <sup>1)</sup> $I_F = 36000 \text{ mA}$ $\Phi_e$	Ordering Code
LE B P3W 01-GZHZ-24	24000 ... 45000 mW	Q65112A4108
LE B P3W 01-GZHZ-VW	24000 ... 45000 mW	Q65112A4119

## Maximum Ratings

Parameter	Symbol		Values
Operating Temperature	$T_{op}$	min.	-40 °C
		max.	125 °C
Storage Temperature	$T_{stg}$	min.	-40 °C
		max.	125 °C
Junction Temperature	$T_j$	max.	150 °C
Forward Current $T_j = 150$ °C; all chips operated in parallel	$I_F$	min.	600 mA
		max.	30000 mA
Forward Current pulsed $D = 0.25$ ; $f = 240$ Hz; $T_B = 25$ °C; all chips operated in parallel	$I_{F\ pulse}$		48000 mA
Surge Current $t_p \leq 10$ $\mu$ s; $D = 0.1$ ; $T_j = 150$ °C; all chips operated in parallel	$I_{FS}$	max.	60000 mA
ESD withstand voltage acc. to ANSI/ESDA/JEDEC JS-001 (HBM, Class 2)	$V_{ESD}$		2 kV
Reverse current <sup>2)</sup>	$I_R$	max.	200 mA

## Characteristics

$T_{\text{Board}} = 25\text{ °C}$ ;  $I_{\text{F}} = 36000\text{ mA}$ ;  $f = 1000\text{ Hz}$ ;  $t_{\text{int}} = 100\text{ ms}$ ;  $D = 0.25$ ; all chips operated in parallel

Parameter	Symbol		Values
Peak Wavelength	$\lambda_{\text{peak}}$	typ.	455 nm
Dominant Wavelength <sup>3)</sup>	$\lambda_{\text{dom}}$	min.	444 nm
		typ.	459 nm
		max.	465 nm
Spectral bandwidth at 50% $I_{\text{rel,max}}$	$\Delta\lambda$	typ.	27 nm
Viewing angle at 50% $I_{\text{V}}$	$2\varphi$	typ.	120 °
Radiating surface	$A_{\text{color}}$	typ.	4.8 x 2.6 mm <sup>2</sup>
Partial Flux acc. CIE 127:2007 <sup>4)</sup> $I_{\text{F}} = 36000\text{ mA}$	$\Phi_{\text{EV}, 120^\circ}$	typ.	0.82
Forward Voltage <sup>5)</sup> $I_{\text{F}} = 36000\text{ mA}$ ; all chips operated in parallel	$V_{\text{F}}$	min.	3.20 V
		typ.	3.35 V
		max.	4.30 V
Deviation of forward voltage of all chips	$V_{\text{F}}$	max.	135 mV
Reverse voltage (ESD device)	$V_{\text{RESD}}$	min.	45 V
Reverse voltage <sup>2)</sup> $I_{\text{R}} = 20\text{ mA}$	$V_{\text{R}}$	max.	1.2 V
Real thermal resistance junction/board	$R_{\text{thJB real}}$	typ.	0.5
Electrical thermal resistance junction/board with efficiency $\eta_{\text{e}} = 24\%$	$R_{\text{thJB elec.}}$	typ.	0.38

## Brightness Groups

Group	Total radiant flux <sup>1)</sup> $I_F = 36000 \text{ mA}$ min. $\Phi_e$	Total radiant flux <sup>1)</sup> $I_F = 36000 \text{ mA}$ max. $\Phi_e$
GZ	24000 mW	28000 mW
HX	28000 mW	33000 mW
HY	33000 mW	39000 mW
HZ	39000 mW	45000 mW

## Wavelength Groups

Group	Dominant Wavelength <sup>3)</sup> min. $\lambda_{\text{dom}}$	Dominant Wavelength <sup>3)</sup> max. $\lambda_{\text{dom}}$
V	444 nm	448 nm
W	448 nm	452 nm
2	452 nm	456 nm
3	456 nm	460 nm
4	460 nm	465 nm

## Group Name on Label

### Example: GZ-2

Brightness	Wavelength
GZ	2

### Relative Spectral Emission <sup>4)</sup>

$E_{rel} = f(\lambda)$ ;  $I_F = 36000 \text{ mA}$ ;  $T_J = 25 \text{ }^\circ\text{C}$ ; all chips operated in parallel

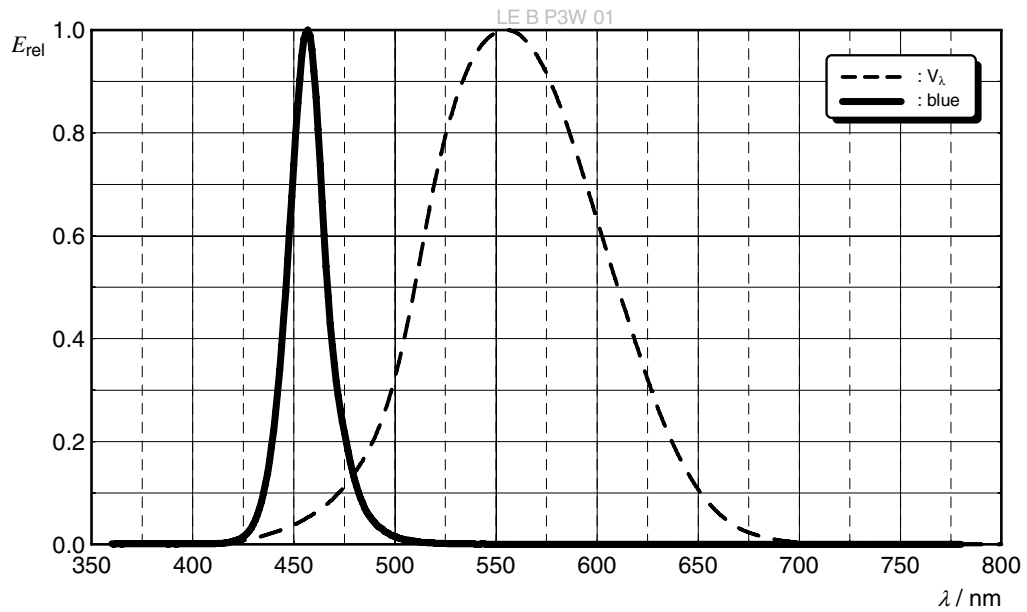

### Radiation Characteristics <sup>4)</sup>

$I_{rel} = f(\phi)$ ;  $T_J = 25 \text{ }^\circ\text{C}$

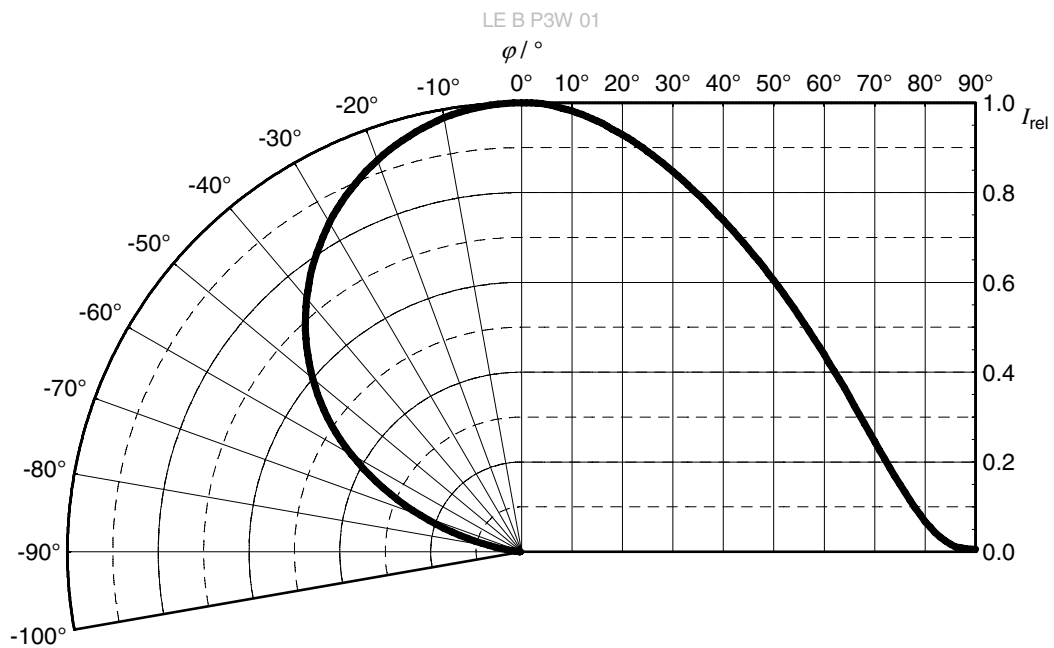

Not for new design

### Relative Partial Flux <sup>4)</sup>

$$\Phi_E(2\varphi)/\Phi_E(180^\circ) = f(\varphi); T_j = 25^\circ\text{C}$$

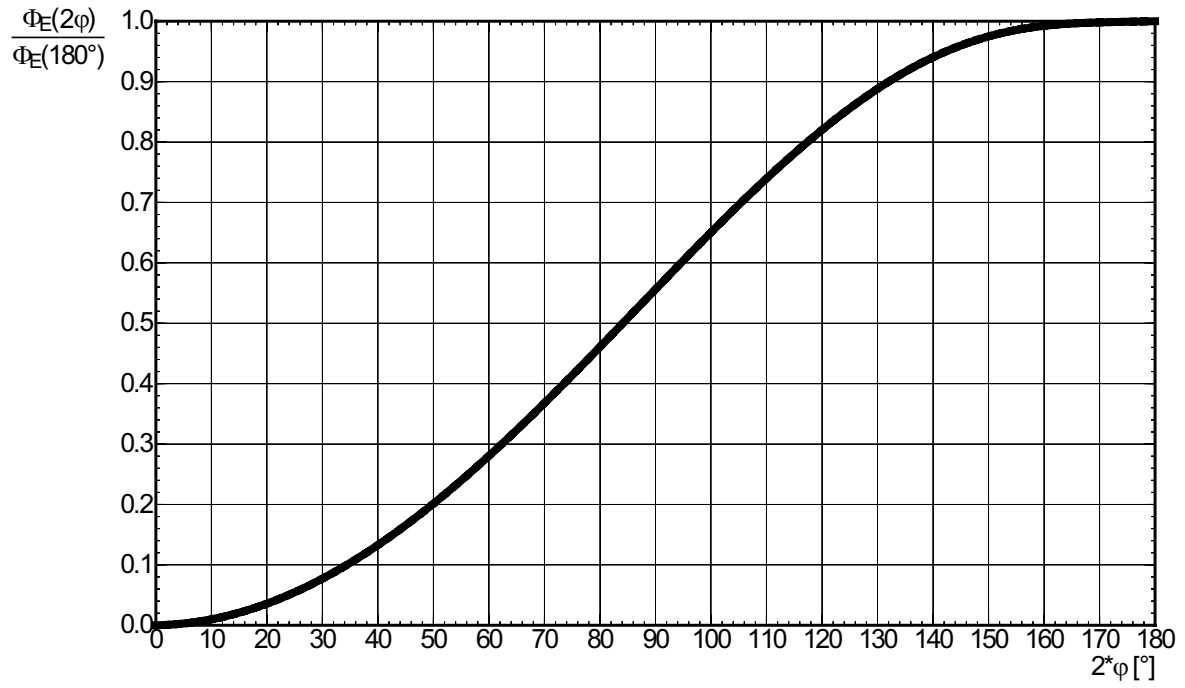

**Forward current** <sup>4), 6)</sup>

$I_F = f(V_F); T_J = 25\text{ °C};$   
all chips operated in parallel

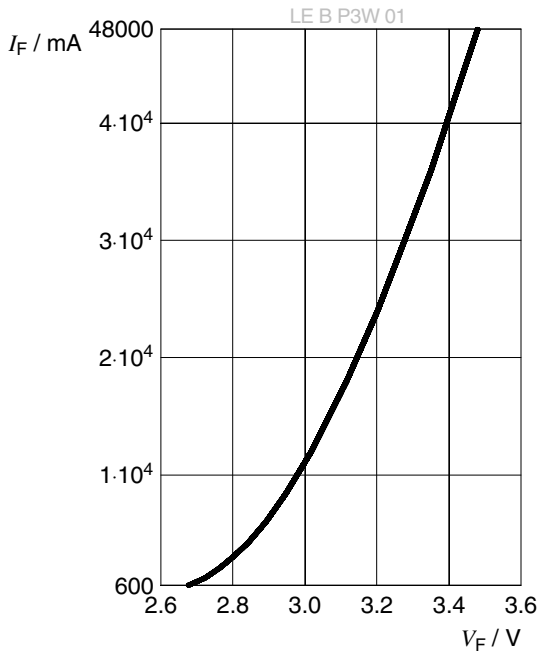

**Relative Radiant Power** <sup>4), 6)</sup>

$\Phi_E / \Phi_E(36000\text{ mA}) = f(I_F); T_J = 25\text{ °C};$   
all chips operated in parallel

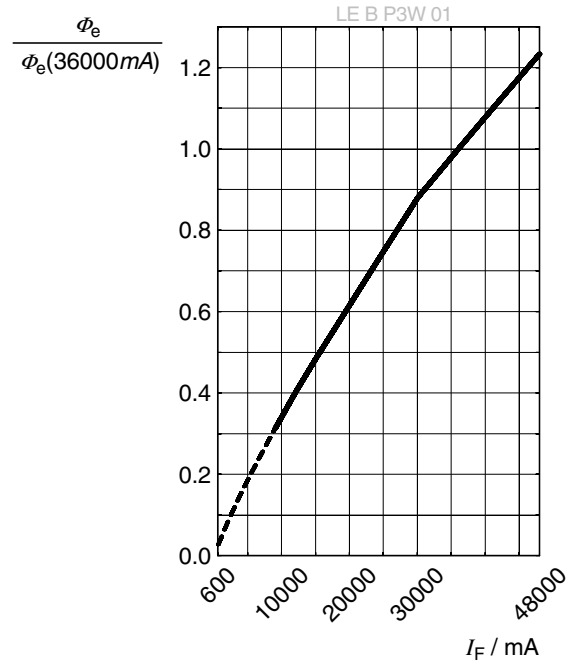

**Dominant Wavelength** <sup>4)</sup>

$\Delta\lambda_{dom} = f(I_F); T_J = 25\text{ °C};$   
all chips operated in parallel

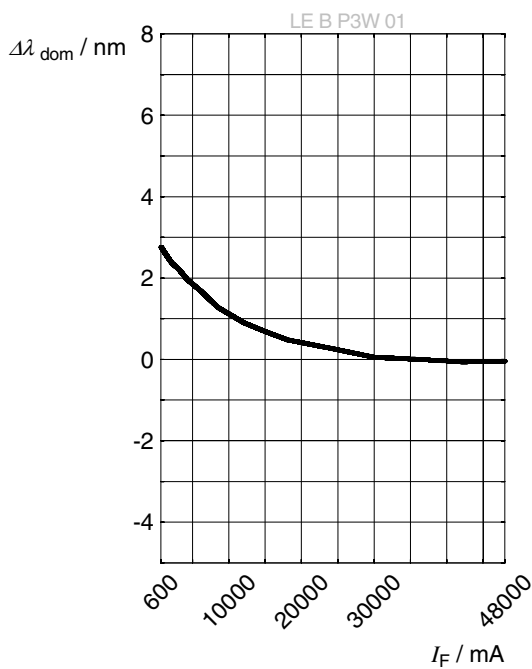

Not for new design

### Forward Voltage <sup>4)</sup>

$\Delta V_F = V_F - V_F(25\text{ °C}) = f(T_J)$ ;  $I_F = 36000\text{ mA}$ ;  
all chips operated in parallel

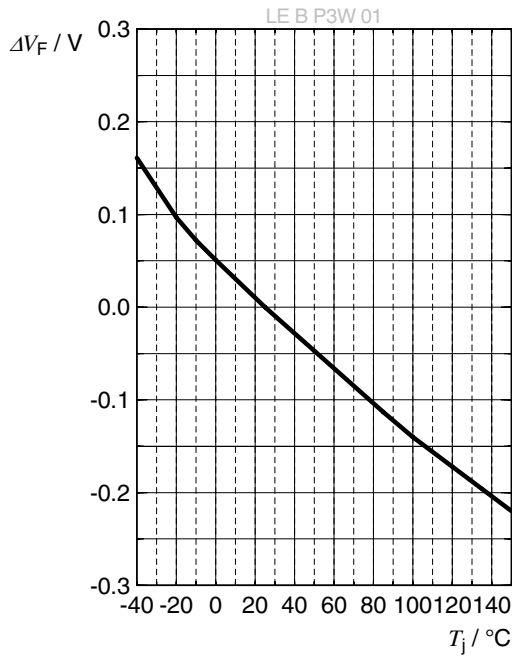

### Relative Radiant Power <sup>4)</sup>

$\Phi_E / \Phi_E(25\text{ °C}) = f(T_J)$ ;  $I_F = 36000\text{ mA}$ ;  
all chips operated in parallel

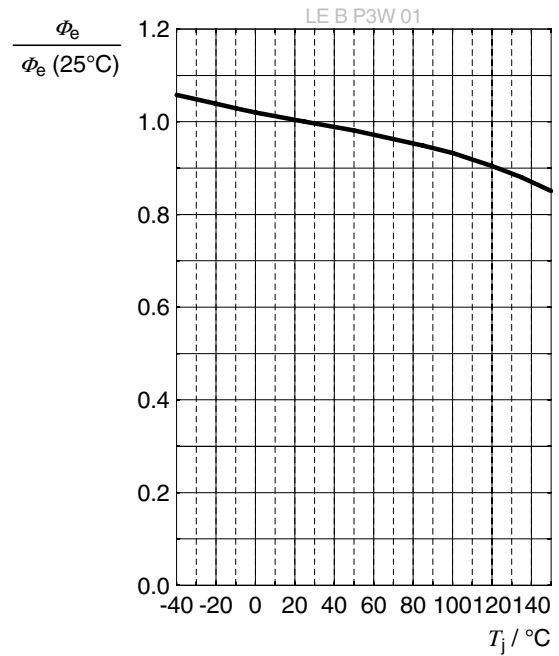

### Dominant Wavelength <sup>4)</sup>

$\Delta \lambda_{\text{dom}} = \lambda_{\text{dom}} - \lambda_{\text{dom}}(25\text{ °C}) = f(T_J)$ ;  $I_F = 36000\text{ mA}$ ;  
all chips operated in parallel

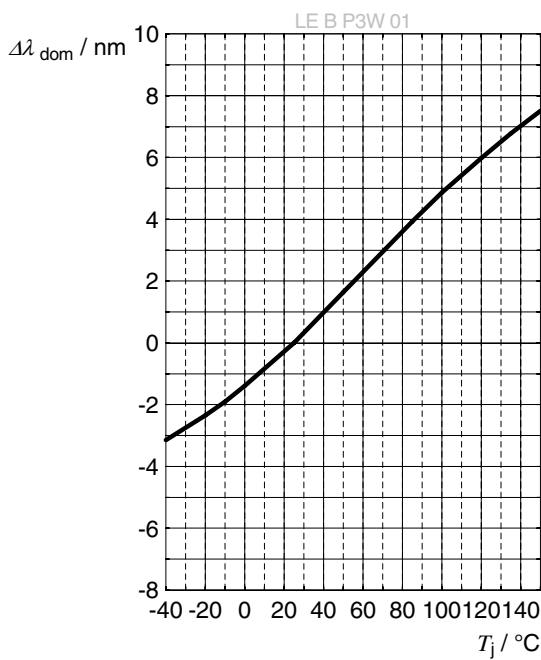

Not for new design



Dimensional Drawing 7)

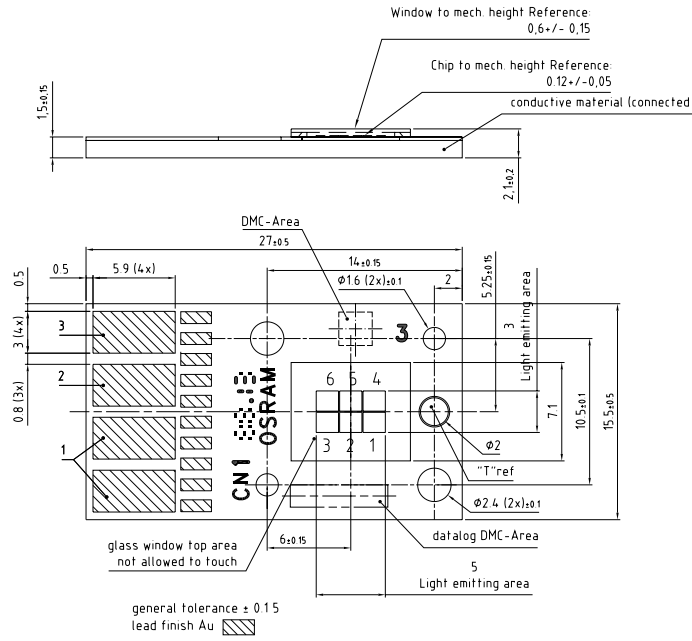

C67062-A0162-A1KA 01

Further Information:

Approximate Weight: 5,000.0 mg

Corrosion test: Class: 3B  
Test condition: 40°C / 90 % RH / 15 ppm H<sub>2</sub>S / 14 days (stricter than IEC 60068-2-43)

ESD advice: The device is protected by ESD device which is connected in parallel to the Chip.

Notes: Package not suitable for any kind of wet cleaning or ultrasonic cleaning.

Not for new design

## Electrical Internal Circuit

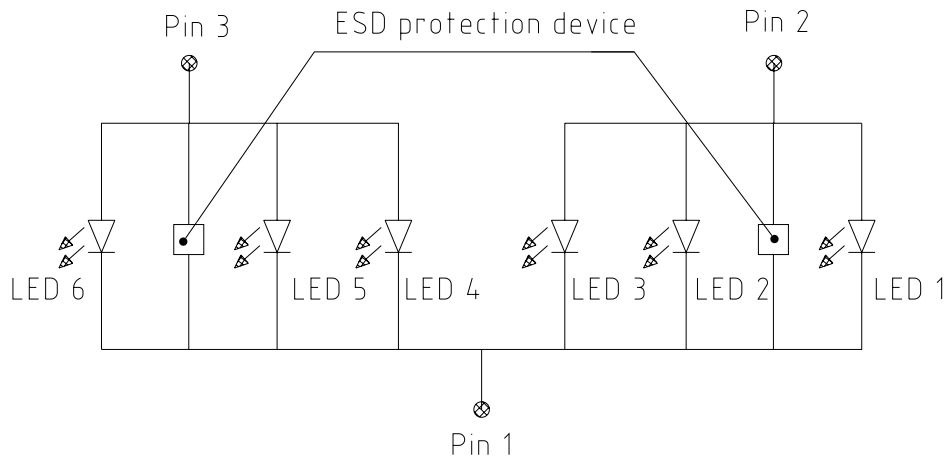

- 1: cathode
- 2: anode Chip 1, 2 and 3
- 3: anode Chip 4, 5 and 6

## Reflow Soldering Profile

Product complies to MSL Level 2 acc. to JEDEC J-STD-020E

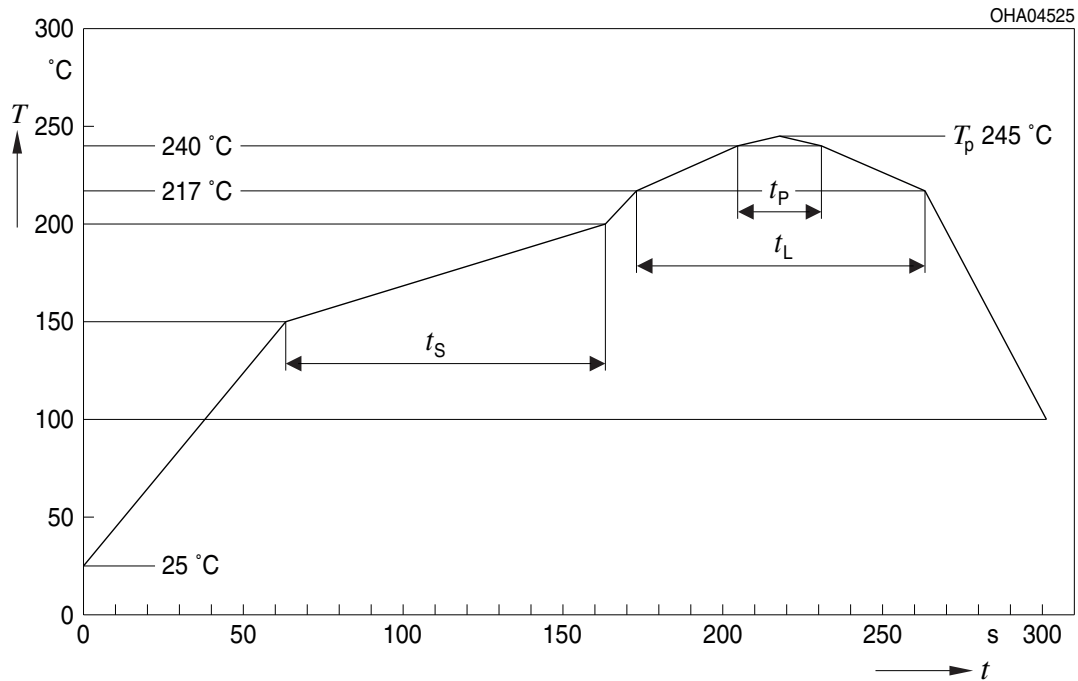

Profile Feature	Symbol	Pb-Free (SnAgCu) Assembly			Unit
		Minimum	Recommendation	Maximum	
Ramp-up rate to preheat <sup>*)</sup> 25 °C to 150 °C			2	3	K/s
Time $t_s$ $T_{Smin}$ to $T_{Smax}$	$t_s$	60	100	120	s
Ramp-up rate to peak <sup>*)</sup> $T_{Smax}$ to $T_p$			2	3	K/s
Liquidus temperature	$T_L$		217		°C
Time above liquidus temperature	$t_L$		80	100	s
Peak temperature	$T_p$		245	260	°C
Time within 5 °C of the specified peak temperature $T_p - 5$ K	$t_p$	10	20	30	s
Ramp-down rate* $T_p$ to 100 °C			3	6	K/s
Time 25 °C to $T_p$				480	s

All temperatures refer to the center of the package, measured on the top of the component  
<sup>\*)</sup> slope calculation  $DT/Dt$ :  $Dt$  max. 5 s; fulfillment for the whole T-range

Not for new design

Taping <sup>7)</sup>

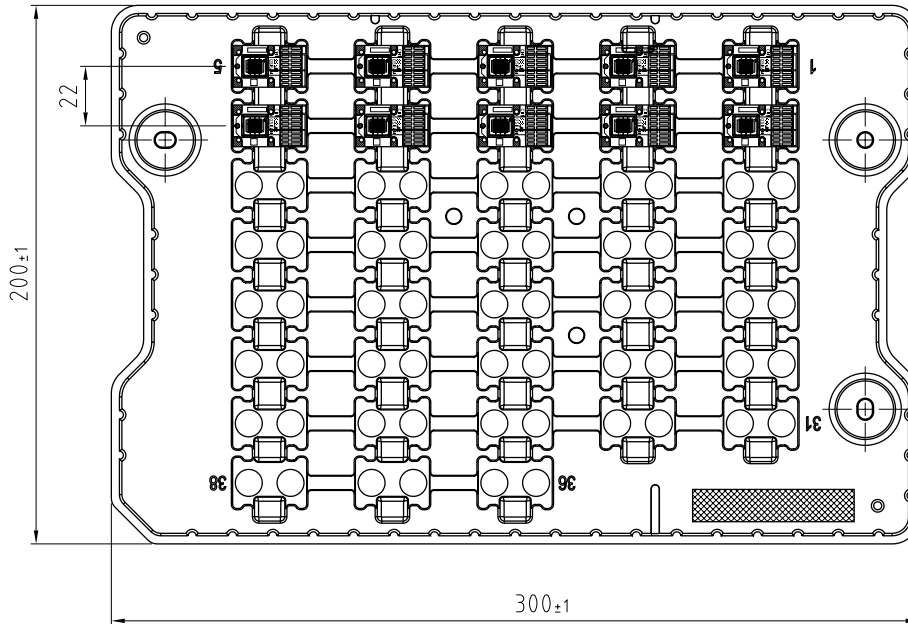

C63062-A4389-B10-01

### Barcode-Product-Label (BPL)

**OSRAM Opto Semiconductors** LX XXXX BIN1: XX-XX-X-XXX-X

RoHS Compliant





(6P) BATCH NO: 1234567890

(1T) LOT NO: 1234567890 (9D) D/C: 1234

(X) PROD NO: 123456789 (Q) QTY: 9999 (G) GROUP: XX-XX-X-X

ML Temp ST  
X XXX °C X

Pack: RXX  
DEMY XXX  
X\_X123\_1234.1234 X



OHA04563

### Barcode-Tray-Label (BTL)

LE xxx xxx Group: xxxx-xxxx-xxxx

Data Matrix Code

xxxx BIN

MATERIAL: Material Number Batch Batch Number BIN: xxxx



OHA02684\_1

## Schematic Transportation Box <sup>7)</sup>

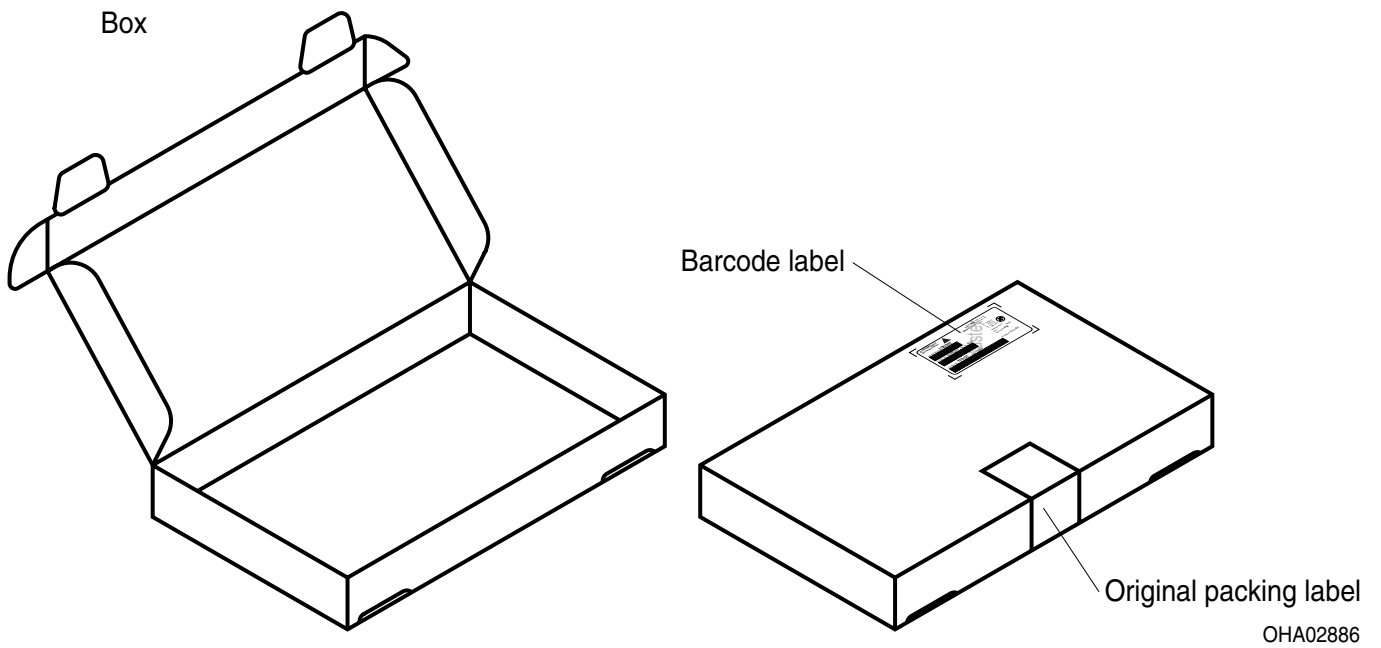

## Dimensions of Transportation Box

Width	Length	Height
333 ± 5 mm	218 ± 5 mm	28 ± 5 mm
337 ± 5 mm	218 ± 5 mm	63 ± 5 mm

## Type Designation System



Not for new design

---

## Notes

The evaluation of eye safety occurs according to the standard IEC 62471:2006 (photo biological safety of lamps and lamp systems). Within the risk grouping system of this IEC standard, the device specified in this data sheet falls into the class **moderate risk (exposure time 0.25 s)**. Under real circumstances (for exposure time, conditions of the eye pupils, observation distance), it is assumed that no endangerment to the eye exists from these devices. As a matter of principle, however, it should be mentioned that intense light sources have a high secondary exposure potential due to their blinding effect. When looking at bright light sources (e.g. headlights), temporary reduction in visual acuity and afterimages can occur, leading to irritation, annoyance, visual impairment, and even accidents, depending on the situation.

Subcomponents of this device contain, in addition to other substances, metal filled materials including silver. Metal filled materials can be affected by environments that contain traces of aggressive substances. Therefore, we recommend that customers minimize device exposure to aggressive substances during storage, production, and use. Devices that showed visible discoloration when tested using the described tests above did show no performance deviations within failure limits during the stated test duration. Respective failure limits are described in the IEC60810.

For further application related information please visit [www.osram-os.com/appnotes](http://www.osram-os.com/appnotes)



## Disclaimer

### **Attention please!**

The information describes the type of component and shall not be considered as assured characteristics. Terms of delivery and rights to change design reserved. Due to technical requirements components may contain dangerous substances.

For information on the types in question please contact our Sales Organization.

If printed or downloaded, please find the latest version on the OSRAM OS website.

### **Packing**

Please use the recycling operators known to you. We can also help you – get in touch with your nearest sales office. By agreement we will take packing material back, if it is sorted. You must bear the costs of transport. For packing material that is returned to us unsorted or which we are not obliged to accept, we shall have to invoice you for any costs incurred.

### **Product and functional safety devices/applications or medical devices/applications**

OSRAM OS components are not developed, constructed or tested for the application as safety relevant component or for the application in medical devices.

OSRAM OS products are not qualified at module and system level for such application.

In case buyer – or customer supplied by buyer – considers using OSRAM OS components in product safety devices/applications or medical devices/applications, buyer and/or customer has to inform the local sales partner of OSRAM OS immediately and OSRAM OS and buyer and /or customer will analyze and coordinate the customer-specific request between OSRAM OS and buyer and/or customer.

---

## Glossary

- 1) **Brightness:** Brightness values are measured during a pulse train of 100 ms with a pulse width of 250  $\mu$ s and a frequency of 1 kHz, with an internal reproducibility of +/- 8 % and an expanded uncertainty of +/- 11 % (acc. to GUM with a coverage factor of  $k = 3$ ). The peak brightness is calculated according to the pulse duration and frequency.
- 2) **Reverse Operation:** This product is intended to be operated applying a forward current within the specified range. Applying any continuous reverse bias or forward bias below the voltage range of light emission shall be avoided because it may cause migration which can change the electro-optical characteristics or damage the LED.
- 3) **Wavelength:** The wavelength is measured during a pulse train of 100 ms with a pulse width of 250  $\mu$ s and a frequency of 1 kHz, with an internal reproducibility of  $\pm 0,5$  nm and an expanded uncertainty of  $\pm 1$  nm (acc. to GUM with a coverage factor of  $k=3$ ).
- 4) **Typical Values:** Due to the special conditions of the manufacturing processes of semiconductor devices, the typical data or calculated correlations of technical parameters can only reflect statistical figures. These do not necessarily correspond to the actual parameters of each single product, which could differ from the typical data and calculated correlations or the typical characteristic line. If requested, e.g. because of technical improvements, these typ. data will be changed without any further notice.
- 5) **Forward Voltage:** The forward voltage is measured during a pulse of typical 250  $\mu$ s, with an internal reproducibility of +/- 0,05 V and an expanded uncertainty of +/- 0,1 V (acc. to GUM with a coverage factor of  $k=3$ ).
- 6) **Characteristic curve:** In the range where the line of the graph is broken, you must expect higher differences between single devices within one packing unit.
- 7) **Tolerance of Measure:** Unless otherwise noted in drawing, tolerances are specified with  $\pm 0.1$  and dimensions are specified in mm.

---

## Revision History

Version	Date	Change
1.2	2018-12-03	New Layout
1.3	2019-09-05	Tray
1.4	2020-06-30	Not for new design

**Published by OSRAM Opto Semiconductors GmbH** EU RoHS and China RoHS compliant product  
**Leibnizstraße 4, D-93055 Regensburg**  
**www.osram-os.com © All Rights Reserved.**



此产品符合欧盟 RoHS 指令的要求；  
按照中国的相关法规和标准，不含有毒有害物质或元素。

Компания «Life Electronics» занимается поставками электронных компонентов импортного и отечественного производства от производителей и со складов крупных дистрибьюторов Европы, Америки и Азии.

С конца 2013 года компания активно расширяет линейку поставок компонентов по направлению коаксиальный кабель, кварцевые генераторы и конденсаторы (керамические, пленочные, электролитические), за счёт заключения дистрибьюторских договоров

Мы предлагаем:

- Конкурентоспособные цены и скидки постоянным клиентам.
- Специальные условия для постоянных клиентов.
- Подбор аналогов.
- Поставку компонентов в любых объемах, удовлетворяющих вашим потребностям.
- Приемлемые сроки поставки, возможна ускоренная поставка.
- Доставку товара в любую точку России и стран СНГ.
- Комплексную поставку.
- Работу по проектам и поставку образцов.
- Формирование склада под заказчика.
- Сертификаты соответствия на поставляемую продукцию (по желанию клиента).
- Тестирование поставляемой продукции.
- Поставку компонентов, требующих военную и космическую приемку.
- Входной контроль качества.
- Наличие сертификата ISO.

В составе нашей компании организован Конструкторский отдел, призванный помогать разработчикам, и инженерам.

Конструкторский отдел помогает осуществить:

- Регистрацию проекта у производителя компонентов.
- Техническую поддержку проекта.
- Защиту от снятия компонента с производства.
- Оценку стоимости проекта по компонентам.
- Изготовление тестовой платы монтаж и пусконаладочные работы.



Тел: +7 (812) 336 43 04 (многоканальный)

Email: [org@lifeelectronics.ru](mailto:org@lifeelectronics.ru)