

PRODUCT NO.  
10018784-X0XXXX

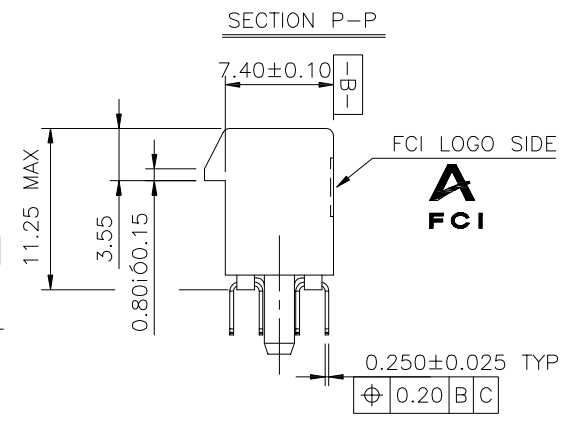

PLASTIC PEG TYPE

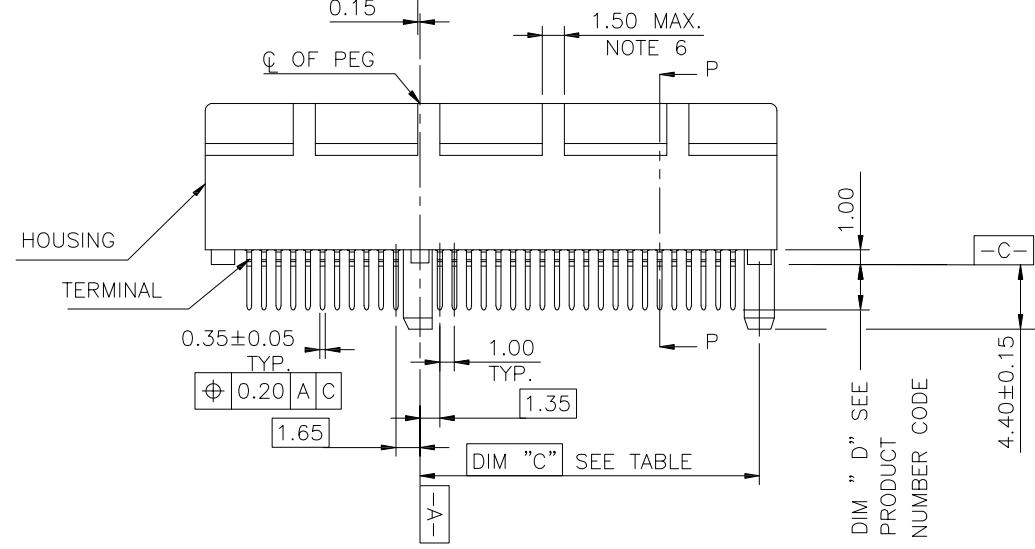
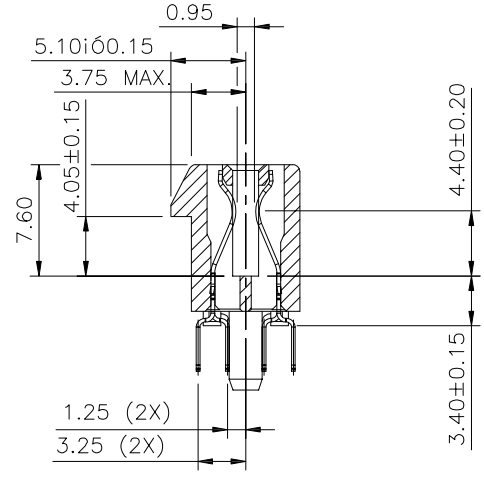
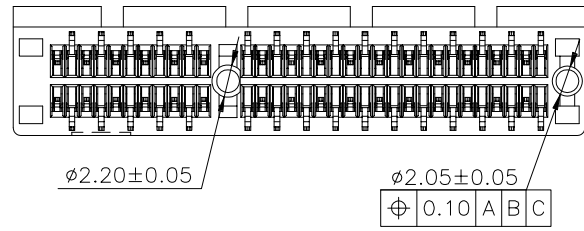

CONFIDENTIAL

mat'l. code				tolerances unless otherwise specified			CUSTOMER COPY	FCI <a href="http://www.fciconnect.com">www.fciconnect.com</a>		
ltr	ecn no	dr	date	linear	.X ± 0.30	projection		title PCI EXPRESS GEN3 CARD EDGE ASSY		
M	T05-0124	M W	06/07/05		.XX ± 0.20		product family EDGE CARD			
N	T05-0153	M W	07/12/05		.XXX ± 0.10		size dwg no			
P	T05-0208	M W	09/15/05	angles	0° ±2°	MM	code TWN			
R	T06-0206	R C	12/01/06	dr	STONE LI 05/27/15		scale 2:1	sheet 1 of 6		
S	ELX-DG-2161-1	S T	05/27/15	enrg	STONE LI 05/27/15	A4 10018784				
				chr	/ /					
				appd	PM ZHENG 05/27/15					
sheet index	revision sheet	S 1	S 2	S 3	S 4	S 5	S 6	cage code 22526		

PRODUCT NO.  
10018784-X1XXXX

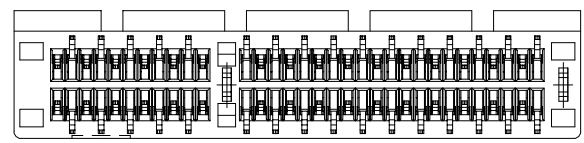

METAL BOARD LOCKS TYPE

CONFIDENTIAL

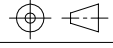
mat'l. code				tolerances unless otherwise specified		CUSTOMER COPY		 www.fciconnect.com	
ltr	ecn no	dr	date	linear	.X ± 0.30	projection	title		
				angles	.XX ± 0.20		PCI EXPRESS GEN3 CARD EDGE ASSY		
				dr	.XXX ± 0.10	MM	product family	EDGE CARD	code
				enr	0° ±2°	←	size	dwg no	TWN
				chr		→	A4	10018784	sheet
				appd		scale			2 of
sheet index	revision sheet								

cage code  
22526

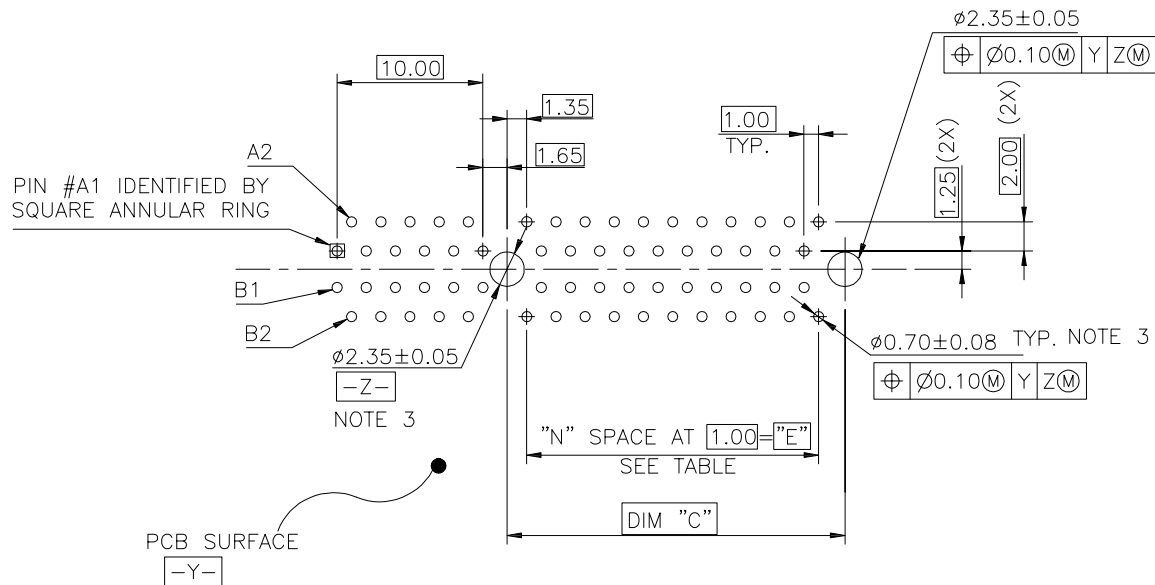

← I/O PANEL DIRECTION

RECOMMENDED FOOTPRINT

CONFIDENTIAL

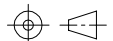
mat'l. code				tolerances unless otherwise specified			CUSTOMER COPY		 www.fciconnect.com		
ltr	ecn no	dr	date	linear	.X ±		projection	title			
					.XX ±			PCI EXPRESS GEN3			
					.XXX ±			CARD EDGE ASS'Y			
				angles	0° ±2°		 MM	product family		code	
				dr	STONE LI	05/27/15		EDGE CARD		TWN	
				enr	STONE LI	05/27/15	size   dwg no		sheet		
				chr	/	/	A4   10018784		3 of		
				appd	PM ZHENG	05/27/15	scale				
sheet index		revision sheet					2:1				

cage code  
22526



SCALE 2:1

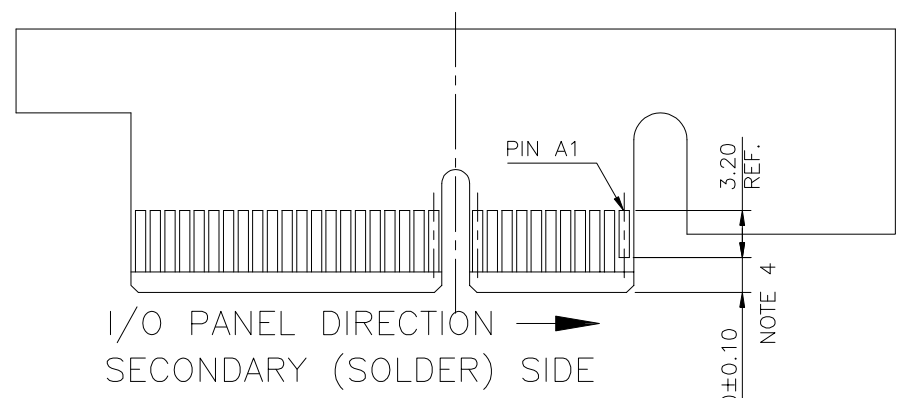

ADD-IN CARD EDGE-FINGER DIMENSIONS

#	POS	REF.	N	DIM "G"	"F"
36	6		6	8.15	B17
64	20		20	22.15	B31
98	37		37	39.15	B48
164	70		70	72.15	B81

PIN "F" SEE TABLE 2.40±0.10

CONFIDENTIAL

mat'l. code				tolerances unless otherwise specified		CUSTOMER COPY	 www.fciconnect.com	
ltr	ecn no	dr	date	linear	.X ±		projection	title
					.XX ±			PCI EXPRESS GEN3
				angles	.XXX ±			CARD EDGE ASS'Y
					0° ±2°	MM	product family	
				dr	STONE LI 05/27/15		EDGE CARD	
				enr	STONE LI 05/27/15	scale	size	
				chr	/ /		dwg no	
				appd	PM ZHENG 05/27/15	2:1	A4	10018784
sheet index	revision sheet							code
								TWN
								sheet
								4 of

cage code 22526

NOTES:

1.MATERIAL:

HOUSING: NYLON, GLASS FILLED UL94V-0 RATE, SUITABLE FOR WAVE SOLDERING.

TERMINAL: COPPER ALLOY

PLATING: 50u" NICKEL UNDERPLATE ALL OVER  
CONTACT AREA PLATING - SEE PRODUCT NUMBER CODE  
SOLDER TAIL: TIN/LEAD (90/10) - SEE PRODUCT

METAL BOARD LOCKS: COPPER ALLOY  
FINISH: 100u" TIN/LEAD (90/10) OVER 50u" NICKEL  
UNDERPLATE SEE PRODUCT NUMBER CODE

2.PRODUCT SPECIFICATION: GS-12-233

③THE HORIZONTAL AXIS FOR THE HOLE PATTERN IS ESTABLISHED BY A LINE THROUGH THE CENTER OF THE TWO Ø2.35 HOLES.  
THE VERTICAL AXIS IS 90° TO THE HORIZONTAL AXIS, THROUGH THE CENTER OF DATUM Z.

④NO TIE BAR PERMITTED FROM CARD EDGE TO LEADING EDGE OF PAD FOR PINS A1 AND PIN NUMBERS "F".

⑤CHAMFER EDGES MUST BE FREE OF CUTTING BURRS.

⑥FREQUENCY & LOCATION AT SUPPLIER DISCRETION. RIDGE MAY BE CONTINUOUS WITH NO BREAKS.

7.RoHS COMPATIBLE PRODUCT SPECIFICATIONS

a - PLATING:

- "LF" MEANS THE PRODUCT IS LEAD-FREE, 2um MINIMUM MATTE TIN OVER 1.27um MINIMUM NICKEL UNDERPLATE.

b - MANUFACTURING PROCESS COMPATIBILITY

- THE HOUSING WILL WITHSTAND EXPOSURE TO 260°C±5°C SOLDER BATH TEMPERATURE FOR 5 SECONDS IN A WAVE SOLDER APPLICATION WITH A 1.6mm MIN THICK CIRCUIT BOARD.  
- THE HOUSING WILL WITHSTAND EXPOSURE TO 240°C±5°C SOLDER BATH TEMPERATURE FOR 5 SECONDS IN A WAVE SOLDER APPLICATION WITH A 1.6mm MIN THICK CIRCUIT BOARD.(For 10018784-X 0 X X X X(X X) options)

CONNECTOR	# POS REF.	N	DIM "A"	DIM "B"	DIM "C"	"E"
1 PORT	36	6	7.65	25.00	9.15	6.00
4 PORT	64	20	21.65	39.00	23.15	20.00
8 PORT	98	37	38.65	56.00	40.15	37.00
16 PORT	164	70	71.65	89.00	73.15	70.00

PRODUCT NUMBER CODE  
10018784-X X X X X X □ □

HOUSING COLOR OPTIONS

- 0-WHITE
- 1-BLACK

PEGS OPTIONS

- 0-PLASTIC PEGS
- 1-METAL BOARD LOCKS

TERMINAL PLATING OPTIONS

- 0-50u" Ni UNDERPLATE  
30u" Au CONTACT AREA  
100u" TIN TAIL AREA ----- COMPATIBLE RoHS
- 1-50u" Ni UNDERPLATE  
15u" Au CONTACT AREA  
100u" TIN TAIL AREA ----- COMPATIBLE RoHS
- 2-50u" Ni UNDERPLATE  
GOLD FLASH CONTACT AREA  
100u" TIN TAIL AREA ----- COMPATIBLE RoHS
- 3-50u" Ni UNDERPLATE  
30u" Au CONTACT AREA  
100u" TIN/LEAD TAIL AREA ----- INCOMPLIANT RoHS
- 4-50u" Ni UNDERPLATE  
15u" Au CONTACT AREA  
100u" TIN/LEAD TAIL AREA ----- INCOMPLIANT RoHS
- 5-50u" Ni UNDERPLATE  
GOLD FLASH CONTACT AREA  
100u" TIN/LEAD TAIL AREA ----- INCOMPLIANT RoHS

LEAD FREE OPTION

LEAVE BLANK FOR TERMINAL PLATING 3,4,5  
"LF" FOR TERMINAL PLATING OPTION 0,1,2

POS OPTIONS

- 0-36
- 1-64
- 2-98
- 3-164

PACKAGING OPTIONS

T-TRAY PACKAGING  
M-TRAY PACKAGING & MYLAR TAPE FOR PICK-N-PLACE. SEE FIGURE 1

TAIL LENGTH OPTIONS

	DIM "D"	PCB THICKNESS	BOARD LOCKS DIM"G"
0	2.30 <sup>+0.25</sup> / <sub>-0.13</sub>	1.56±0.10	1.70±0.15
1	3.10 <sup>+0.25</sup> / <sub>-0.13</sub>	2.36±0.10	2.50±0.15

CONFIDENTIAL



www.fciconnect.com

CUSTOMER COPY

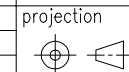

title PCI EXPRESS GEN3 CARD EDGE ASS'Y

product family EDGE CARD

code TWN

size A4

dwg no 10018784

scale 1:1

sheet 5 of



mat'l. code				tolerances unless otherwise specified			CUSTOMER COPY	
ltr	ecn no	dr	date	linear	.X ±	projection	title	
					.XX ±		PCI EXPRESS GEN3 CARD EDGE ASS'Y	
				angles	.XXX ±			
				dr	0° ±2°	MM	product family	
				enr	STONE LI 05/27/15	←	EDGE CARD	
				chr	STONE LI 05/27/15	→	code	
				appd	/ /	scale	TWN	
					PM ZHENG 05/27/15	1:1	sheet	
sheet index	revision sheet						5 of	

cage code 22526

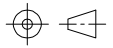

FIGURE 1

CONFIDENTIAL

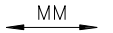
mat'l. code				tolerances unless otherwise specified			CUSTOMER COPY	 www.fciconnect.com		
ltr	ecn no	dr	date	linear	.X ± 0.25	projection				
					.XX ± 0.13		title			
				angles	.XXX ± 0.05		PCI EXPRESS GEN3 CARD EDGE ASS'Y 			
				dr	STONE LI	05/27/15		product family		code
				enr	STONE LI	05/27/15		EDGE CARD		TWN
				chr	/	/	scale	size		sheet
				appd	PM ZHENG	05/27/15		1.5:1	A4	10018784
sheet index		revision sheet								

cage code 22526

Компания «Life Electronics» занимается поставками электронных компонентов импортного и отечественного производства от производителей и со складов крупных дистрибьюторов Европы, Америки и Азии.

С конца 2013 года компания активно расширяет линейку поставок компонентов по направлению коаксиальный кабель, кварцевые генераторы и конденсаторы (керамические, пленочные, электролитические), за счёт заключения дистрибьюторских договоров

Мы предлагаем:

- Конкурентоспособные цены и скидки постоянным клиентам.
- Специальные условия для постоянных клиентов.
- Подбор аналогов.
- Поставку компонентов в любых объемах, удовлетворяющих вашим потребностям.
- Приемлемые сроки поставки, возможна ускоренная поставка.
- Доставку товара в любую точку России и стран СНГ.
- Комплексную поставку.
- Работу по проектам и поставку образцов.
- Формирование склада под заказчика.
- Сертификаты соответствия на поставляемую продукцию (по желанию клиента).
- Тестирование поставляемой продукции.
- Поставку компонентов, требующих военную и космическую приемку.
- Входной контроль качества.
- Наличие сертификата ISO.

В составе нашей компании организован Конструкторский отдел, призванный помогать разработчикам, и инженерам.

Конструкторский отдел помогает осуществить:

- Регистрацию проекта у производителя компонентов.
- Техническую поддержку проекта.
- Защиту от снятия компонента с производства.
- Оценку стоимости проекта по компонентам.
- Изготовление тестовой платы монтаж и пусконаладочные работы.



Тел: +7 (812) 336 43 04 (многоканальный)  
Email: [org@lifeelectronics.ru](mailto:org@lifeelectronics.ru)