

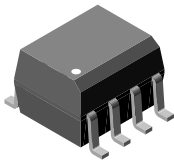

# Optocoupler, Phototransistor Output, Dual Channel, SOIC-8 package, 110 °C Rated

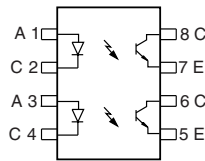

1179018



### FEATURES

- Operating temperature from - 55 °C to + 110 °C
- Two Channel Coupler
- SOIC-8 Surface Mountable Package
- Isolation Test Voltage, 4000 V<sub>RMS</sub>
- Compatible with Dual Wave, Vapor Phase and IR Reflow Soldering
- Lead (Pb)-free component
- Component in accordance to RoHS 2002/95/EC and WEEE 2002/96/EC



RoHS COMPLIANT

### DESCRIPTION

The 110 °C rated ILD1205T/1206T/1207T are optically coupled pairs with a Gallium Arsenide infrared LED and a silicon NPN phototransistor. Signal information, including a DC level, can be transmitted by the device while maintaining a high degree of electrical isolation between input and output. The ILD1205T/1206T/1207T come in a standard SOIC-8 small outline package for surface mounting which makes it ideally suited for high density applications with limited space. In addition to eliminating through-holes requirements, this package conforms to standards for surface mounted devices.

A specified minimum and maximum CTR allows a narrow tolerance in the electrical design of the adjacent circuits. The high BV<sub>CEO</sub> of 70 V gives a higher safety margin compared to the industry standard of 30 V.

### AGENCY APPROVALS

- UL - File No. E52744 System Code Y
- CUL - File No. E52744, equivalent to CSA bulletin 5A
- DIN EN 60747-5-2(VDE0884)  
Available with Option 1

### APPLICATIONS

- AC Adapters
- PLCs
- Switch Mode Power Supplies
- DC/DC Converters
- Microprocessor I/O Interfaces
- General impedance matching circuits

ORDER INFORMATION	
PART	REMARKS
ILD1205T	CTR 40 - 80 %, SOIC-8
ILD1206T	CTR 63 - 125 %, SOIC-8
ILD1207T	CTR 100 - 200 %, SOIC-8

Note:  
For additional information on the available options refer to Option Information.

<b>ABSOLUTE MAXIMUM RATINGS<sup>1)</sup></b>				
PARAMETER	TEST CONDITION	SYMBOL	VALUE	UNIT
<b>INPUT</b>				
Continuous forward current per channel		$I_F$	30	mA
Peak reverse voltage		$V_R$	6.0	V
Peak pulsed current	1.0 $\mu$ s, 300 pps	$I_{FSM}$	1.0	A
Power dissipation		$P_{diss}$	50	mW
Derate linearly from 25 °C			0.5	mW/°C
<b>OUTPUT</b>				
Collector-emitter voltage		$V_{CE}$	70	V
Power dissipation per channel		$P_{diss}$	125	mW
Derate linearly from 25 °C			1.25	mW/°C
<b>COUPLER</b>				
Isolation test voltage	t = 1.0 s	$V_{ISO}$	4000	$V_{RMS}$
Operating temperature		$T_{amb}$	- 55 to + 110	°C
Total package dissipation ambient (2 LEDs + 2 detectors, 2 channels)		$P_{tot}$	300	mW
Derate linearly from 25 °C			4.0	mW/°C
Storage temperature		$T_{stg}$	- 55 to + 150	°C

Note:

<sup>1)</sup>  $T_{amb} = 25\text{ °C}$ , unless otherwise specified.

Stresses in excess of the absolute Maximum Ratings can cause permanent damage to the device. Functional operation of the device is not implied at these or any other conditions in excess of those given in the operational sections of this document. Exposure to absolute Maximum Rating for extended periods of the time can adversely affect reliability.

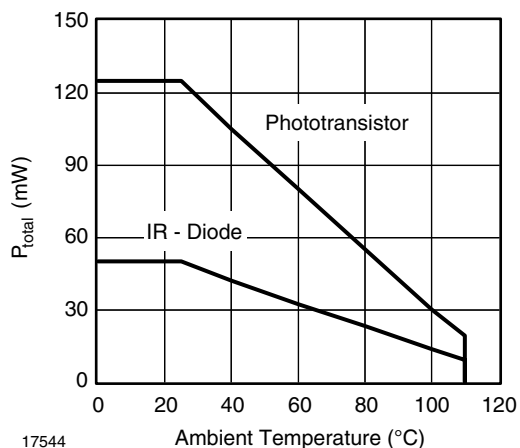

17544  
Figure 1. Power Dissipation vs. Ambient Temperature

ELECTRICAL CHARACTERISTICS <sup>1)</sup>							
PARAMETER	TEST CONDITION	PART	SYMBOL	MIN	TYP.	MAX	UNIT
<b>INPUT</b>							
Forward voltage	$I_F = 10 \text{ mA}$		$V_F$		1.2	1.55	V
Reverse current	$V_R = 6.0 \text{ V}$		$I_R$		0.1	100	$\mu\text{A}$
Capacitance	$V_R = 0$		$C_I$		25		pF
<b>OUTPUT</b>							
Collector-emitter leakage current	$V_{CE} = 10 \text{ V}, I_F = 0$		$I_{CEO}$		5.0	50	nA
Collector-emitter breakdown voltage	$I_C = 100 \mu\text{A}$		$BV_{CEO}$	70			V
Emitter-collector breakdown voltage	$I_E = 10 \mu\text{A}$		$BV_{ECO}$	7.0			V
Collector-emitter saturation voltage	$I_F = 10 \text{ mA}, I_C = 2.5 \text{ mA}$		$V_{CEsat}$			0.4	V
Collector-emitter capacitance	$V_{CE} = 0$		$C_{CE}$		10		pF
<b>COUPLER</b>							
DC Current Transfer Ratio	$V_{CE} = 5.0 \text{ V}, I_F = 10 \text{ mA}$	ILD1205T	CTR	40		80	%
		ILD1206T	CTR	63		125	%
		ILD1207T	CTR	100		200	%
Capacitance (input-output)			$C_{IO}$		0.5		pF

Note:

<sup>1)</sup>  $T_{amb} = 25 \text{ }^\circ\text{C}$ , unless otherwise specified.

Minimum and maximum values are testing requirements. Typical values are characteristics of the device and are the result of engineering evaluation. Typical values are for information only and are not part of the testing requirements.

SWITCHING CHARACTERISTICS							
PARAMETER	TEST CONDITION	PART	SYMBOL	MIN.	TYPE	MAX	UNIT
Turn-on time	$I_C = 2.0 \text{ mA}, R_L = 100 \Omega,$ $V_{CC} = 5.0 \text{ V}$		$t_{on}$	5.0			$\mu\text{s}$
Turn-off time	$I_C = 2.0 \text{ mA}, R_L = 100 \Omega,$ $V_{CC} = 5.0 \text{ V}$		$t_{off}$	4.0			$\mu\text{s}$

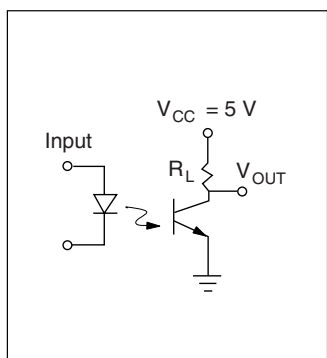

iiid205t\_08

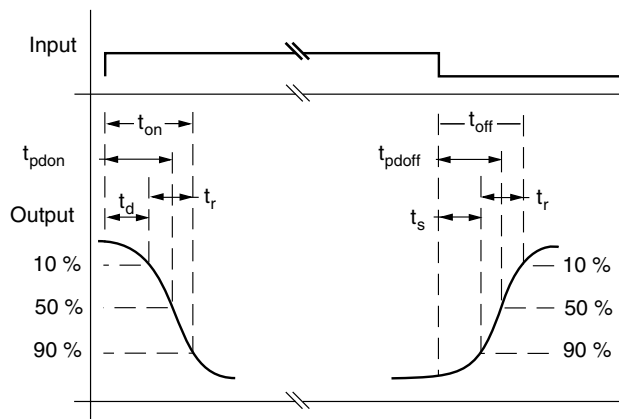

Figure 2. Switching Test Circuit

SAFETY AND INSULATION RATINGS <sup>1)</sup>							
PARAMETER	TEST CONDITION	PART	SYMBOL	MIN.	TYPE	MAX.	UNIT
Climatic Classification (according to IEC 68 part 1)					55/110/21		
Polution Degree (DIN VDE 0109)					2.0		mm
Comparative tracking index per DIN IEC112/VDE 0303 part 1, group IIIa per DIN VDE 6110 175 399				175		399	
$V_{IOTM}$			$V_{IOTM}$	6000			V
$V_{IORM}$			$V_{IORM}$	560			V
Resistance, input to output			$R_{IO}$		100		$\Omega$
$P_{SI}$						350	mW
$I_{SI}$						150	mA
$T_{SI}$						165	$^{\circ}C$
Creeepage				4.0			mm
Clearance				4.0			mm

Note:

<sup>1)</sup> As per IEC60747-5-2, §7.4.3.8.1, this optocoupler is suitable for "safe electrical insulation" only within the safety ratings. Compliance with the safety ratings shall be ensured by means of protective circuits.

## TYPICAL CHARACTERISTICS

$T_{amb} = 25^{\circ}C$ , unless otherwise specified

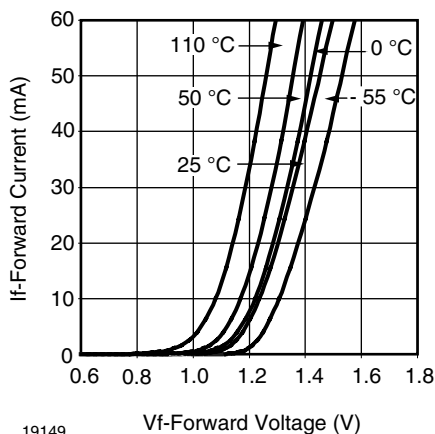

19149 Figure 3. Forward Current vs. Forward Voltage

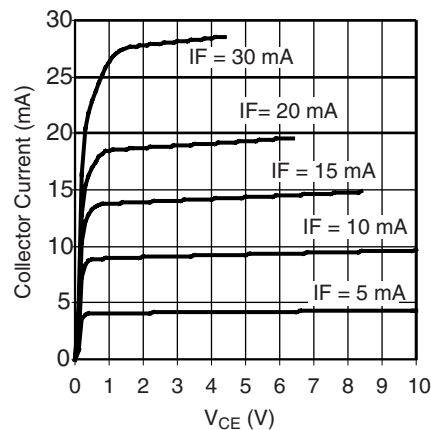

Figure 4.  $V_{CE}$  vs.  $I_C$ , (Non-Saturated)

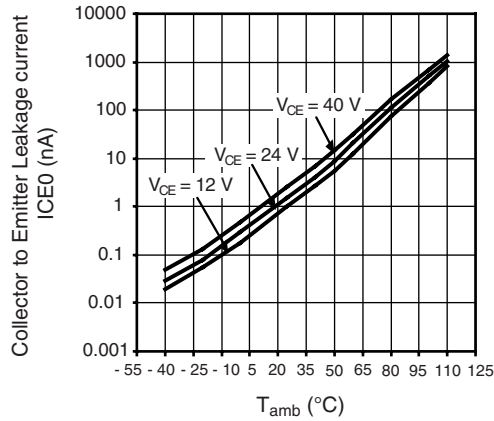
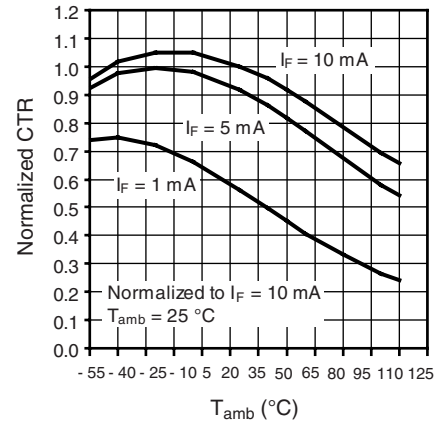

Figure 5. Collector to Emitter Leakage Current vs. Ambient Temperature



Normalized CTR vs. Ambient Temperature (Non-Saturated,  $V_{CE} = 5 V$ )

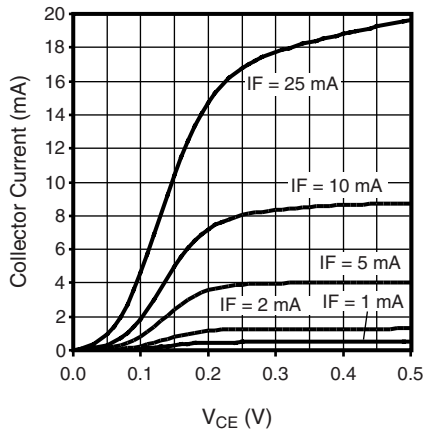

Figure 6.  $V_{CE}$  vs.  $I_C$  (Saturated)

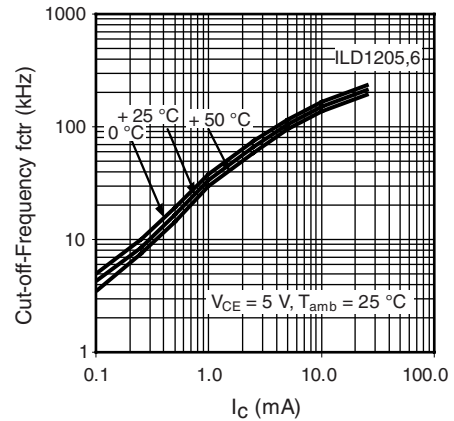

Figure 8. Cut-off-Frequency (- 3 dB) vs. Collector Current

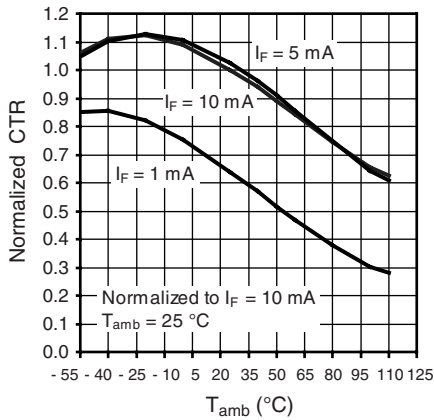

Figure 7. Normalized CTR vs. Ambient Temperature (Saturated,  $V_{CE} = 0.4 V$ )

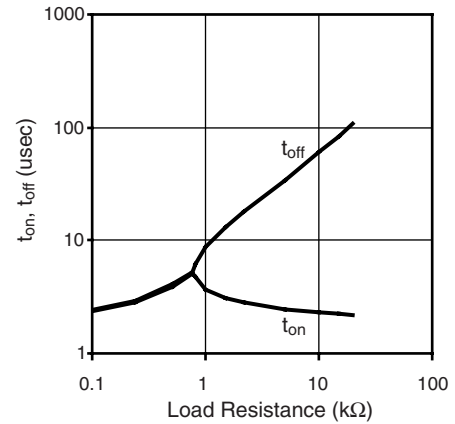

Figure 9.  $t_{on}$ ,  $t_{off}$  vs. Load Resistance (100  $\Omega$  to 20000  $\Omega$ )



**OZONE DEPLETING SUBSTANCES POLICY STATEMENT**

It is the policy of Vishay Semiconductor GmbH to

1. Meet all present and future national and international statutory requirements.
2. Regularly and continuously improve the performance of our products, processes, distribution and operating systems with respect to their impact on the health and safety of our employees and the public, as well as their impact on the environment.

It is particular concern to control or eliminate releases of those substances into the atmosphere which are known as ozone depleting substances (ODSs).

The Montreal Protocol (1987) and its London Amendments (1990) intend to severely restrict the use of ODSs and forbid their use within the next ten years. Various national and international initiatives are pressing for an earlier ban on these substances.

Vishay Semiconductor GmbH has been able to use its policy of continuous improvements to eliminate the use of ODSs listed in the following documents.

1. Annex A, B and list of transitional substances of the Montreal Protocol and the London Amendments respectively
2. Class I and II ozone depleting substances in the Clean Air Act Amendments of 1990 by the Environmental Protection Agency (EPA) in the USA
3. Council Decision 88/540/EEC and 91/690/EEC Annex A, B and C (transitional substances) respectively.

Vishay Semiconductor GmbH can certify that our semiconductors are not manufactured with ozone depleting substances and do not contain such substances.

We reserve the right to make changes to improve technical design  
and may do so without further notice.

Parameters can vary in different applications. All operating parameters must be validated for each customer application by the customer. Should the buyer use Vishay Semiconductors products for any unintended or unauthorized application, the buyer shall indemnify Vishay Semiconductors against all claims, costs, damages, and expenses, arising out of, directly or indirectly, any claim of personal damage, injury or death associated with such unintended or unauthorized use.

Vishay Semiconductor GmbH, P.O.B. 3535, D-74025 Heilbronn, Germany



## Notice

Specifications of the products displayed herein are subject to change without notice. Vishay Intertechnology, Inc., or anyone on its behalf, assumes no responsibility or liability for any errors or inaccuracies.

Information contained herein is intended to provide a product description only. No license, express or implied, by estoppel or otherwise, to any intellectual property rights is granted by this document. Except as provided in Vishay's terms and conditions of sale for such products, Vishay assumes no liability whatsoever, and disclaims any express or implied warranty, relating to sale and/or use of Vishay products including liability or warranties relating to fitness for a particular purpose, merchantability, or infringement of any patent, copyright, or other intellectual property right.

The products shown herein are not designed for use in medical, life-saving, or life-sustaining applications. Customers using or selling these products for use in such applications do so at their own risk and agree to fully indemnify Vishay for any damages resulting from such improper use or sale.



Компания «Life Electronics» занимается поставками электронных компонентов импортного и отечественного производства от производителей и со складов крупных дистрибьюторов Европы, Америки и Азии.

С конца 2013 года компания активно расширяет линейку поставок компонентов по направлению коаксиальный кабель, кварцевые генераторы и конденсаторы (керамические, пленочные, электролитические), за счёт заключения дистрибьюторских договоров

Мы предлагаем:

- Конкурентоспособные цены и скидки постоянным клиентам.
- Специальные условия для постоянных клиентов.
- Подбор аналогов.
- Поставку компонентов в любых объемах, удовлетворяющих вашим потребностям.
- Приемлемые сроки поставки, возможна ускоренная поставка.
- Доставку товара в любую точку России и стран СНГ.
- Комплексную поставку.
- Работу по проектам и поставку образцов.
- Формирование склада под заказчика.
- Сертификаты соответствия на поставляемую продукцию (по желанию клиента).
- Тестирование поставляемой продукции.
- Поставку компонентов, требующих военную и космическую приемку.
- Входной контроль качества.
- Наличие сертификата ISO.

В составе нашей компании организован Конструкторский отдел, призванный помогать разработчикам, и инженерам.

Конструкторский отдел помогает осуществить:

- Регистрацию проекта у производителя компонентов.
- Техническую поддержку проекта.
- Защиту от снятия компонента с производства.
- Оценку стоимости проекта по компонентам.
- Изготовление тестовой платы монтаж и пусконаладочные работы.



Тел: +7 (812) 336 43 04 (многоканальный)  
Email: [org@lifeelectronics.ru](mailto:org@lifeelectronics.ru)