



Specification C8WT803

SSC		CUSTOMER
Drawn	Approval	Approval

Rev.06

September 2011

www.seoulsemicon.com

SSC- QP- 7- 07- 24 (Rev.00)

CONTENTS

1. Description
2. Absolute Maximum Ratings
3. Electro-Optical Characteristics
4. Optical characteristics
5. Reliability Test
6. Color & Binning
7. Bin Code Description
8. Outline Dimension
9. Reel Structure
10. Packing
11. Soldering
12. Precaution for use
13. Handling of Silicone Resin LEDs



C8WT803

C8WT803

1. Description

This surface-mount LED comes in standard package dimension. It has a substrate made up of a molded plastic reflector sitting on top of a bent lead frame. The die is attached within the reflector cavity and the cavity is encapsulated by silicone.



The package design coupled with careful selection of component materials allow these products to perform with high reliability.

Features

- White colored SMT package.
- Pb-free Reflow Soldering Application
- Suitable for all SMT assembly methods ; Suitable for all soldering methods
- RoHS Compliant

Applications

- Interior lighting
- General lighting
- Indoor and out door displays
- Architectural / Decorative lighting

Rev.06

September 2011

www.seoulsemicon.com

SSC- QP- 7- 07- 24 (Rev.00)

2. Absolute maximum ratings [1]

Parameter	Symbol	Value	Unit
Power Dissipation	P_d	111	mW
Forward Current	I_F	30	mA
Operating Temperature	T_{opr}	-40~+85	°C
Storage Temperature	T_{stg}	-40~+100	°C
Junction Temperature	T_j	125	°C

[1] Care is to be taken that power dissipation does not exceed the absolute maximum rating of the product.

* LED's properties might be different from suggested values like above and below tables if operation condition will be exceeded our parameter range.

3. Electro-Optical characteristics

Parameter	Symbol	Condition	Min.	Typ.	Max.	Unit
Forward Voltage	V_F	$I_F=20\text{mA}$	2.9	3.2	3.4	V
Reverse Voltage	I_R	$V_F=5\text{V}$	-	-	10	μA
Luminous Intensity* ^[1]	I_v	$I_F=20\text{mA}$	-	1,800	-	Mcd
Color Correlated Temperature	CCT	$I_F=20\text{mA}$	2,600	-	7,000	K
Viewing Angle ^[2]	$2\theta_{1/2}$	$I_F=20\text{mA}$	-	115	-	deg.
Color Rendering Index*	Ra	$I_F=20\text{mA}$	75	80	-	-
ESD (HBM)		1.5k Ω ; 100pF	1	-	-	KV
Thermal resistance ^[3]	R_{thJS}	$I_F=20\text{mA}$		76		°C/W

[1] The luminous intensity I_v was measured at the peak of the spatial pattern which may not be aligned with the mechanical axis of the LED package.

[2] $2\theta_{1/2}$ is the off-axis where the luminous intensity is 1/2 of the peak intensity.

[3] Thermal resistance: R_{thJS} (Junction / solder)

* Tolerance : V_F : $\pm 0.1\text{V}$, I_v : $\pm 10\%$, Ra : ± 3 , x,y : ± 0.01

[Note] All measurements were made under the standardized environment of SSC.

4. Optical characteristics

Forward Voltage vs. Forward Current

Ta=25°C

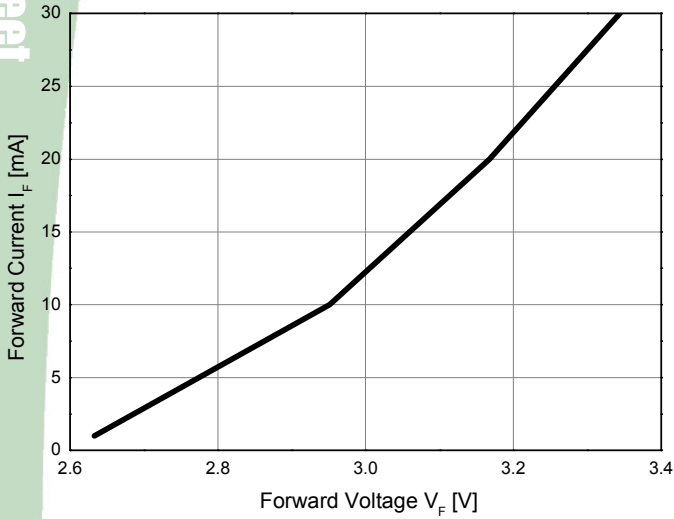

Forward Current vs. Relative Luminous Intensity

Ta=25°C

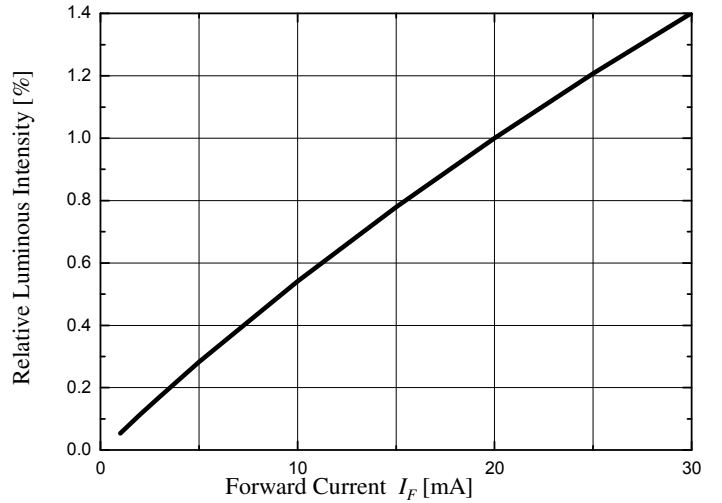

Forward Current vs. Chromaticity Coordinate

Ta=25°C

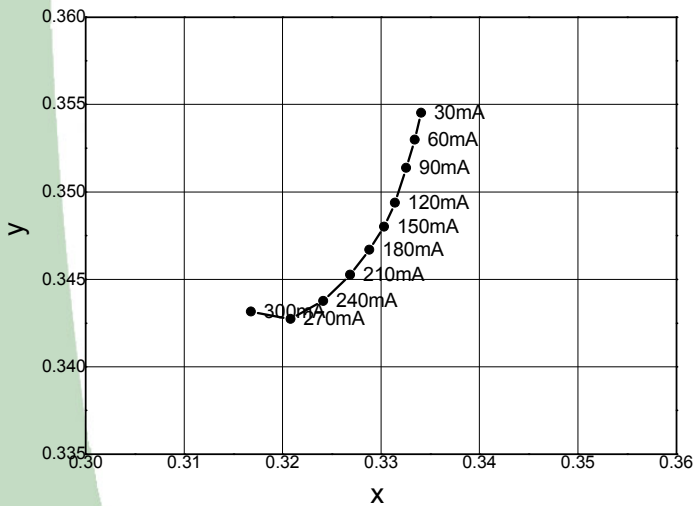

Directivity

Ta=25°C

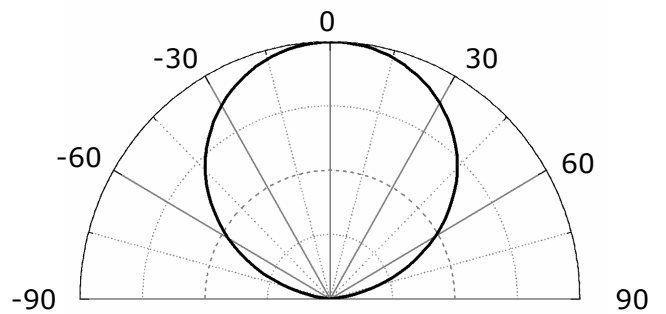

4. Optical characteristics

Forward Voltage Shift vs. Junction Temperature

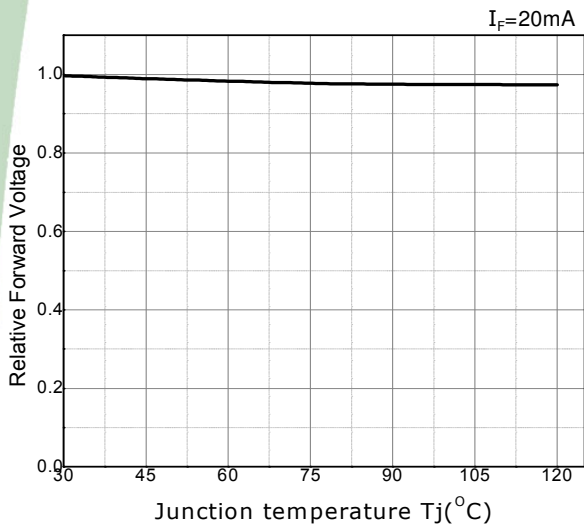

Relative Light Output vs. Junction Temperature

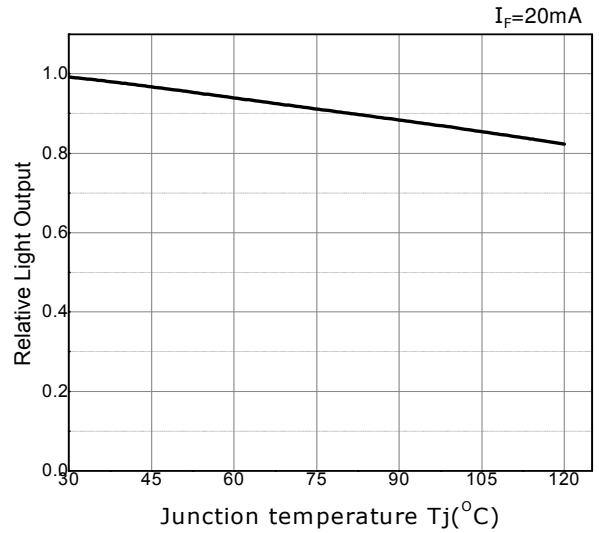

Junction Temperature (°C) vs. Chromaticity Coordinate

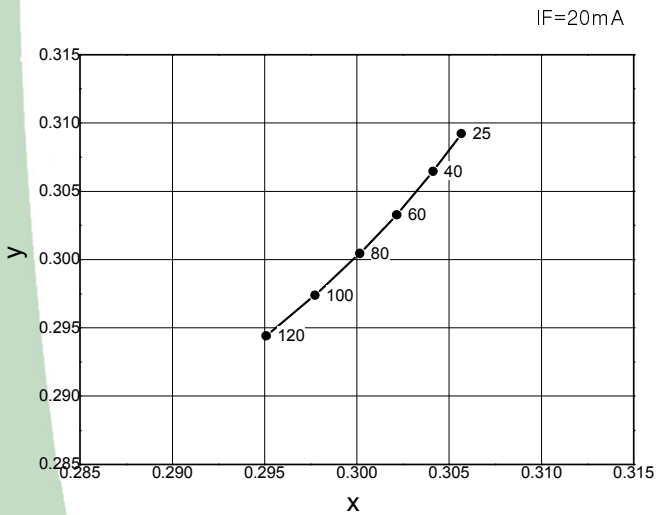

4. Optical characteristics

Ambient Temperature vs. Maximum Forward Current

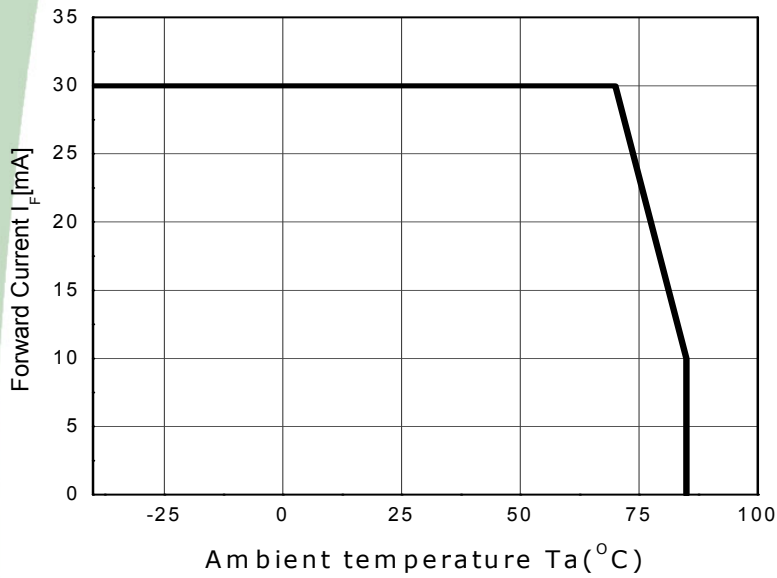

Spectrum

Ta=25°C, I_F=20mA

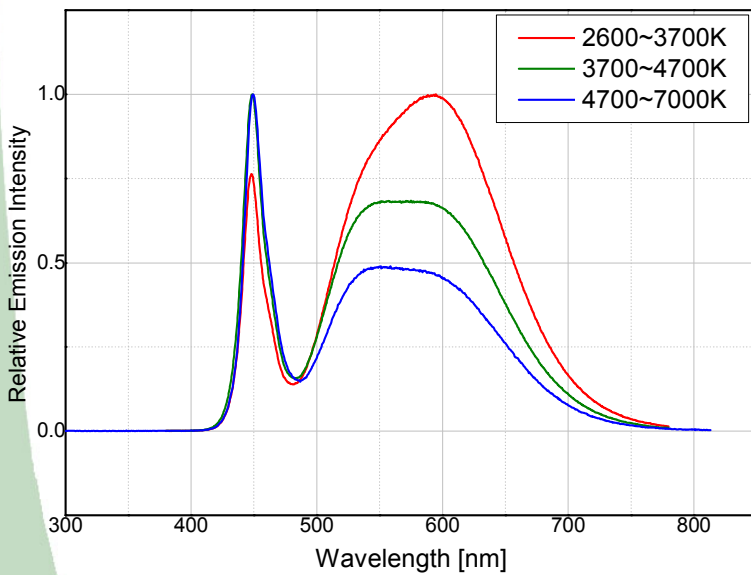

5. Reliability Test

Item	Reference	Test Conditions	Duration / Cycle	Number of Damaged
Thermal Shock	EIAJ ED-4701	$T_a = -40^{\circ}\text{C}(30\text{min}) \sim 100^{\circ}\text{C}(30\text{min})$	100 Cycle	0/22
High Temperature Storage	EIAJ ED-4701	$T_a = 100^{\circ}\text{C}$	1000 Hours	0/22
High Temp. High Humidity Storage	EIAJ ED-4701	$T_a = 60^{\circ}\text{C}, \text{RH}=90\%$	1000 Hours	0/22
Low Temperature Storage	EIAJ ED-4701	$T_a = -40^{\circ}\text{C}$	1000 Hours	0/22
Operating Endurance Test	Internal Reference	$T_a = 25^{\circ}\text{C}, I_F = 20\text{mA}$	1000 Hours	0/22
High Temperature High Humidity Life Test	Internal Reference	$T_a = 60^{\circ}\text{C}, \text{RH}=90\%, I_F = 20\text{mA}$	500 Hours	0/22
High Temperature Life Test	Internal Reference	$T_a = 85^{\circ}\text{C}, I_F = 20\text{mA}$	500 Hours	0/22
Low Temperature Life Test	Internal Reference	$T_a = -40^{\circ}\text{C}, I_F = 20\text{mA}$	1000 Hours	0/22
ESD(HBM)	MIL-STD-883D	1KV at 1.5k Ω ; 100pF	3 Time	0/22
Reflow	T_{sol}	260 $^{\circ}\text{C} < 10\text{sec. Reflow Soldering}$	3 Time	0/22

□ CRITERIA FOR JUDGING THE DAMAGE

Item	Symbol	Condition	Criteria for Judgment	
			MIN	MAX
Forward Voltage	V_F	$I_F = 20\text{mA}$	-	USL ^[1] $\times 1.2$
Luminous Intensity	I_V	$I_F = 20\text{mA}$	LSL ^[2] $\times 0.7$	-

Note : [1] USL : Upper Standard Level
 [2] LSL : Lower Standard Level

6. Color & Binning

CIE Y

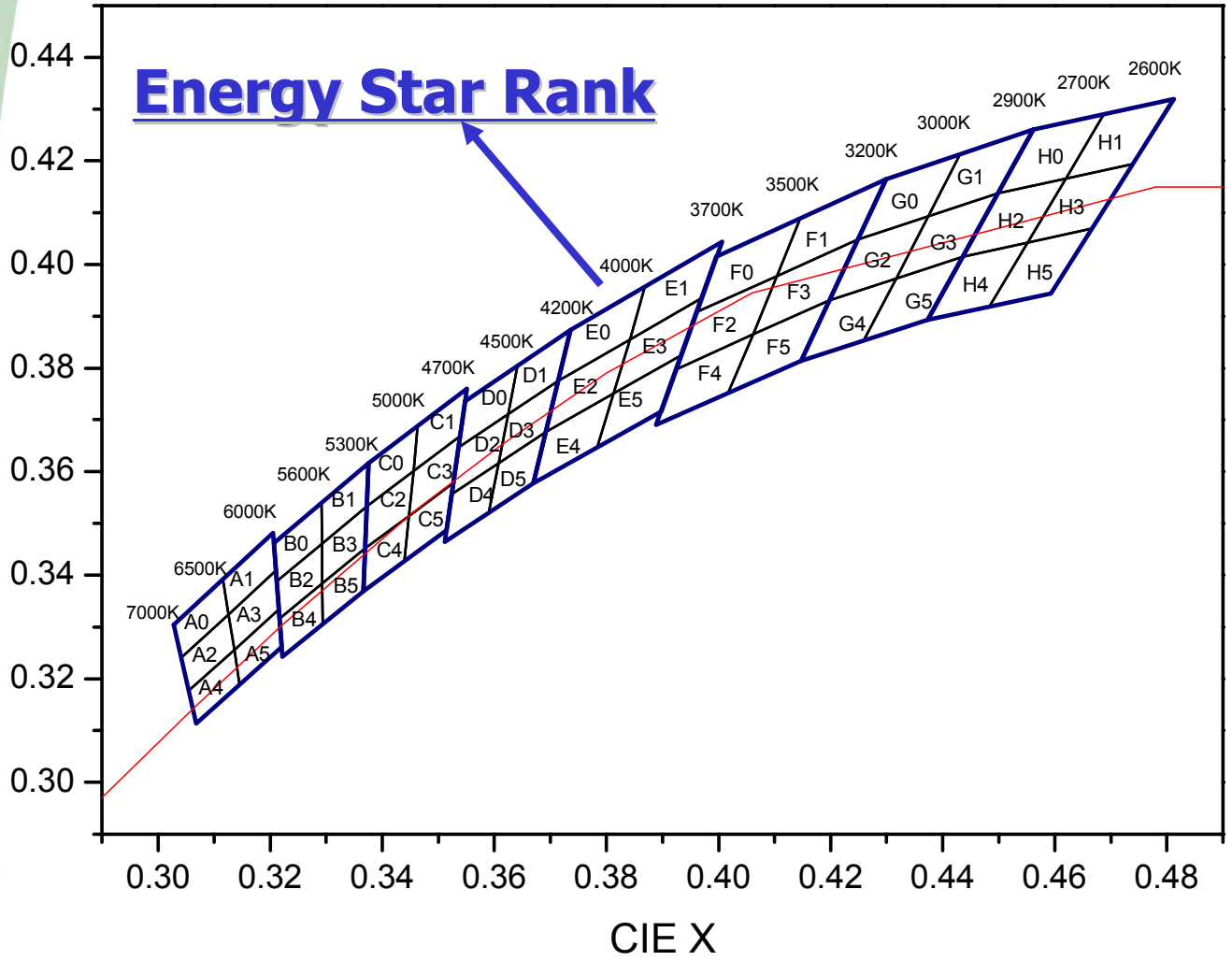



6. Color & Binning

● COLOR RANK

<IF=20mA, Ta=25℃>

A0		A1		A2	
CIE X	CIE Y	CIE X	CIE Y	CIE X	CIE Y
0.3028	0.3304	0.3115	0.3393	0.3041	0.324
0.3041	0.324	0.3126	0.3324	0.3055	0.3177
0.3126	0.3324	0.321	0.3408	0.3136	0.3256
0.3115	0.3393	0.3205	0.3481	0.3126	0.3324
A3		A4		A5	
CIE X	CIE Y	CIE X	CIE Y	CIE X	CIE Y
0.3126	0.3324	0.3055	0.3177	0.3136	0.3256
0.3136	0.3256	0.3068	0.3113	0.3146	0.3187
0.3216	0.3334	0.3146	0.3187	0.3221	0.3261
0.321	0.3408	0.3136	0.3256	0.3216	0.3334
B0		B1		B2	
CIE X	CIE Y	CIE X	CIE Y	CIE X	CIE Y
0.3207	0.3462	0.3292	0.3539	0.3212	0.3389
0.3212	0.3389	0.3293	0.3461	0.3217	0.3316
0.3293	0.3461	0.3373	0.3534	0.3293	0.3384
0.3292	0.3539	0.3376	0.3616	0.3293	0.3461
B3		B4		B5	
CIE X	CIE Y	CIE X	CIE Y	CIE X	CIE Y
0.3293	0.3461	0.3217	0.3316	0.3293	0.3384
0.3293	0.3384	0.3222	0.3243	0.3294	0.3306
0.3369	0.3451	0.3294	0.3306	0.3366	0.3369
0.3373	0.3534	0.3293	0.3384	0.3369	0.3451



6. Color & Binning

● COLOR RANK

<IF=20mA, Ta=25℃>

C0		C1		C2	
CIE X	CIE Y	CIE X	CIE Y	CIE X	CIE Y
0.3376	0.3616	0.3463	0.3687	0.3373	0.3534
0.3373	0.3534	0.3456	0.3601	0.3369	0.3451
0.3456	0.3601	0.3539	0.3669	0.3448	0.3514
0.3463	0.3687	0.3552	0.376	0.3456	0.3601
C3		C4		C5	
CIE X	CIE Y	CIE X	CIE Y	CIE X	CIE Y
0.3456	0.3601	0.3369	0.3451	0.3448	0.3514
0.3448	0.3514	0.3366	0.3369	0.344	0.3428
0.3526	0.3578	0.344	0.3428	0.3514	0.3487
0.3539	0.3669	0.3448	0.3514	0.3526	0.3578
D0		D1		D2	
CIE X	CIE Y	CIE X	CIE Y	CIE X	CIE Y
0.3548	0.3736	0.3641	0.3804	0.3536	0.3646
0.3536	0.3646	0.3625	0.3711	0.3523	0.3555
0.3625	0.3711	0.3714	0.3775	0.3608	0.3616
0.3641	0.3804	0.3736	0.3874	0.3625	0.3711
D3		D4		D5	
CIE X	CIE Y	CIE X	CIE Y	CIE X	CIE Y
0.3625	0.3711	0.3523	0.3555	0.3608	0.3616
0.3608	0.3616	0.3511	0.3465	0.359	0.3521
0.3692	0.3677	0.359	0.3521	0.367	0.3578
0.3714	0.3775	0.3608	0.3616	0.3692	0.3677



6. Color & Binning

● COLOR RANK

<IF=20mA, Ta=25℃>

E0		E1		E2	
CIE X	CIE Y	CIE X	CIE Y	CIE X	CIE Y
0.3736	0.3874	0.3869	0.3958	0.3714	0.3775
0.3714	0.3775	0.3842	0.3855	0.3692	0.3677
0.3842	0.3855	0.397	0.3935	0.3813	0.3751
0.3869	0.3958	0.4006	0.4044	0.3842	0.3855
E3		E4		E5	
CIE X	CIE Y	CIE X	CIE Y	CIE X	CIE Y
0.3842	0.3855	0.3692	0.3677	0.3813	0.3751
0.3813	0.3751	0.367	0.3578	0.3783	0.3646
0.3934	0.3825	0.3783	0.3646	0.3898	0.3716
0.397	0.3935	0.3813	0.3751	0.3934	0.3825
F0		F1		F2	
CIE X	CIE Y	CIE X	CIE Y	CIE X	CIE Y
0.3996	0.4015	0.4146	0.4089	0.396	0.3907
0.396	0.3907	0.4104	0.3978	0.3925	0.3798
0.4104	0.3978	0.4248	0.4048	0.4062	0.3865
0.4146	0.4089	0.4299	0.4165	0.4104	0.3978
F3		F4		F5	
CIE X	CIE Y	CIE X	CIE Y	CIE X	CIE Y
0.4104	0.3978	0.3925	0.3798	0.4062	0.3865
0.4062	0.3865	0.3889	0.369	0.4017	0.3751
0.4198	0.3931	0.4017	0.3751	0.4147	0.3814
0.4248	0.4048	0.4062	0.3865	0.4198	0.3931



6. Color & Binning

● COLOR RANK

<IF=20mA, Ta=25℃>

G0		G1		G2	
CIE X	CIE Y	CIE X	CIE Y	CIE X	CIE Y
0.4299	0.4165	0.443	0.4212	0.4248	0.4048
0.4248	0.4048	0.4374	0.4093	0.4198	0.3931
0.4374	0.4093	0.4499	0.4138	0.4317	0.3973
0.443	0.4212	0.4562	0.426	0.4374	0.4093
G3		G4		G5	
CIE X	CIE Y	CIE X	CIE Y	CIE X	CIE Y
0.4374	0.4093	0.4198	0.3931	0.4317	0.3973
0.4317	0.3973	0.4147	0.3814	0.4259	0.3853
0.4436	0.4015	0.4259	0.3853	0.4373	0.3893
0.4499	0.4138	0.4317	0.3973	0.4436	0.4015
H0		H1		H2	
CIE X	CIE Y	CIE X	CIE Y	CIE X	CIE Y
0.4562	0.426	0.4687	0.4289	0.4499	0.4138
0.4499	0.4138	0.462	0.4166	0.4436	0.4015
0.462	0.4166	0.474	0.4194	0.4551	0.4042
0.4687	0.4289	0.481	0.4319	0.462	0.4166
H3		H4		H5	
CIE X	CIE Y	CIE X	CIE Y	CIE X	CIE Y
0.462	0.4166	0.4436	0.4015	0.4551	0.4042
0.4551	0.4042	0.4373	0.3893	0.4483	0.3919
0.4666	0.4069	0.4483	0.3919	0.4593	0.3944
0.474	0.4194	0.4551	0.4042	0.4666	0.4069

7. Bin Code Description

Bin Code		
Luminous Intensity	Color Rank	Forward Voltage
J8	G1	Z1



2,600K ~ 7,000K

Luminous Intensity [mcd] *[1] @ $I_F = 20\text{mA}$			Flux *[2] [lm]
RANK	Min.	Max.	Typ.
J4	1,400	1,500	3.9
J5	1,500	1,600	4.2
J6	1,600	1,700	4.4
J7	1,700	1,800	4.7
J8	1,800	1,900	5.0
J9	1,900	2,000	5.3
K0	2,000	2,100	5.5
K1	2,100	2,200	5.8
K2	2,200	2,300	6.1
K3	2,300	2,400	6.4
K4	2,400	2,500	6.6

Color Rank @ $I_F = 20\text{mA}$
A~H

Forward Voltage [V] @ $I_F = 20\text{mA}$		
RANK	Min.	Max.
Y	2.9	3.0
Z1	3.0	3.1
Z2	3.1	3.2
Z3	3.2	3.3
A1	3.3	3.4

Available ranks
 Not yet available ranks

CCT	IV Rank										
4700~7000 K	J4	J5	J6	J7	J8	J9	K0	K1	K2	K3	K4
3700~4700 K	J4	J5	J6	J7	J8	J9	K0	K1	K2	K3	K4
2600~3700 K	J4	J5	J6	J7	J8	J9	K0	K1	K2	K3	K4

[Note] All measurements were made under the standardized environment of SSC.
 In order to ensure availability, single color rank will not be orderable.
 [1] Classification criteria : Luminous intensity IV
 [2] Please use for only reference.

8.Outline Dimension

Package Outlines

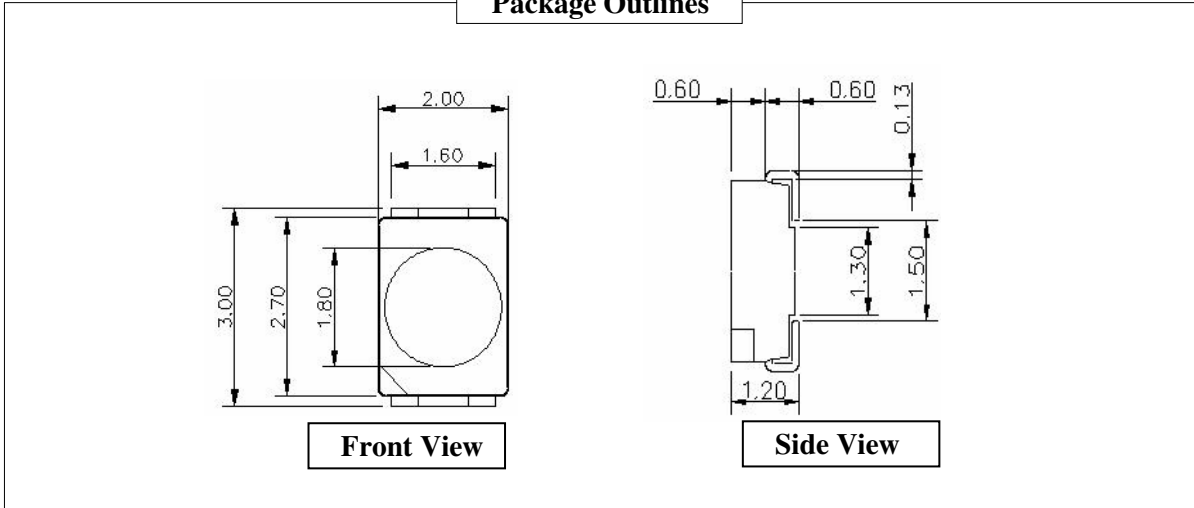

Circuit Diagram

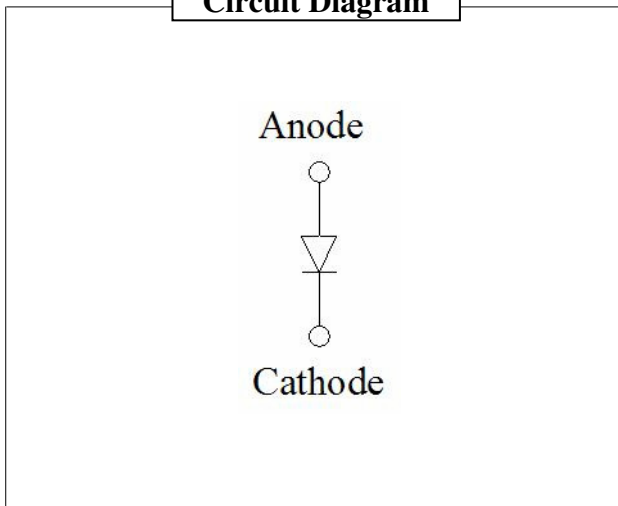

Recommended Solder Pattern

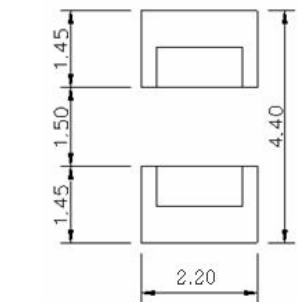

(Tolerance: ± 0.2 , Unit: mm)

9. Reel Structure

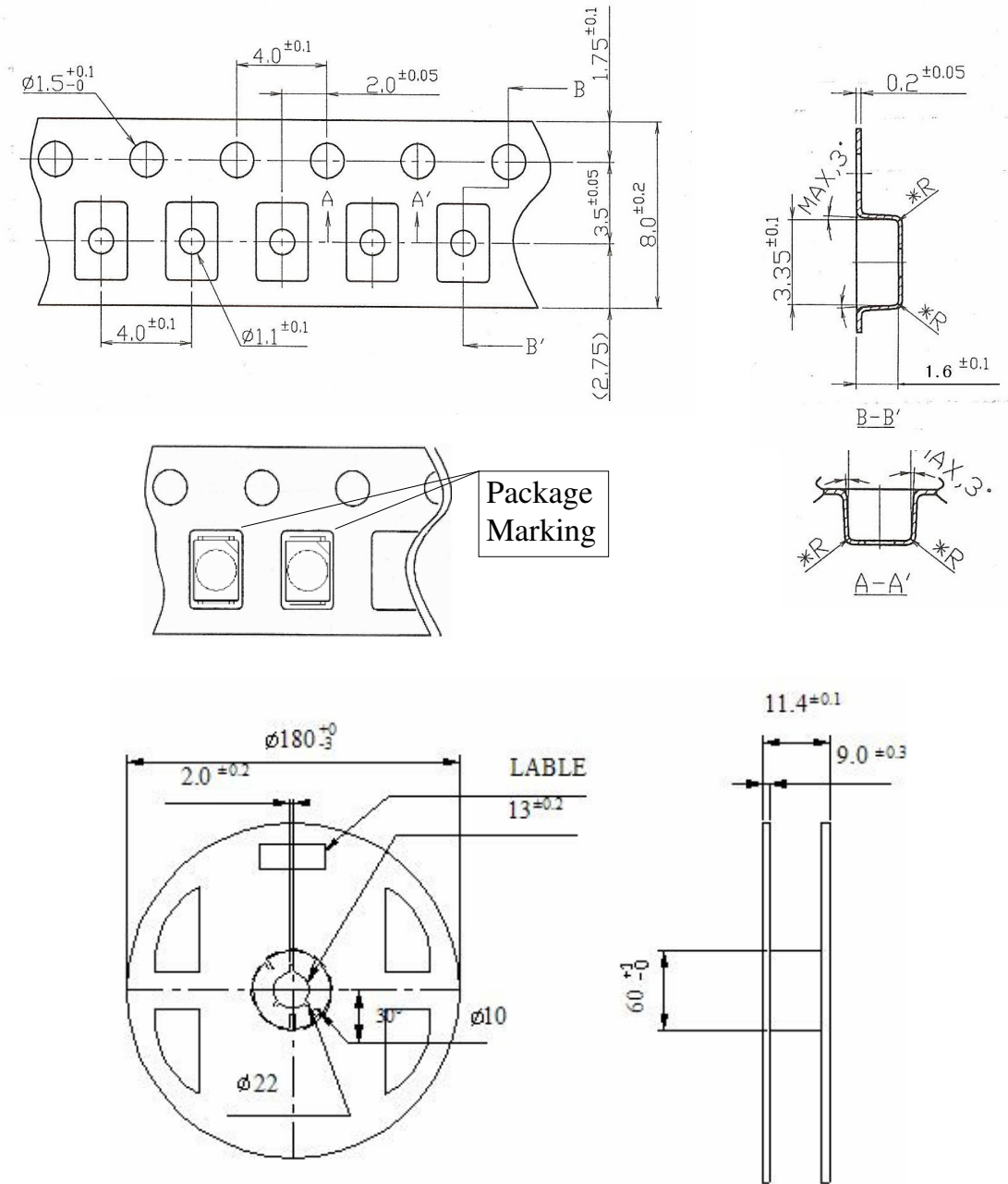

(Tolerance: ± 0.2 , Unit: mm)

- 1)Quantity : 3,000pcs/Reel
- 2)Cumulative Tolerance : Cumulative Tolerance/10 pitches to be $\pm 0.2\text{mm}$
- 3)Adhesion Strength of Cover Tape : Adhesion strength to be 0.1-0.7N when the cover tape is turned off from the carrier tape at the angle of 10 to the carrier tape
- 4)Package : P/N, Manufacturing data Code No. and quantity to be indicated on a damp proof Package

Rev.06

September 2011

www.seoulsemicon.com

SSC- QP- 7- 07- 24 (Rev.00)

10. Packing

Reel

RANK: XXXX
 QUANTITY: XXXX
 LOT NUMBER: XXXXXXXXXXXX
 PART NUMBER: XXXXXXXX
 SEOUL SEMICONDUCTOR CO., LTD.

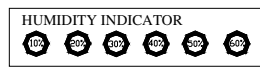
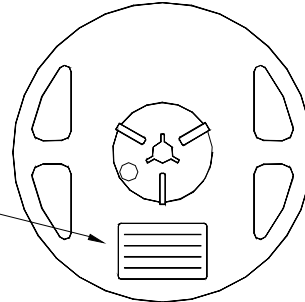

Aluminum Vinyl Bag

RANK: XXXX
 QUANTITY: XXXX
 LOT NUMBER: XXXXXXXXXXXX
 PART NUMBER: XXXXXXXX
 SEOUL SEMICONDUCTOR CO., LTD.

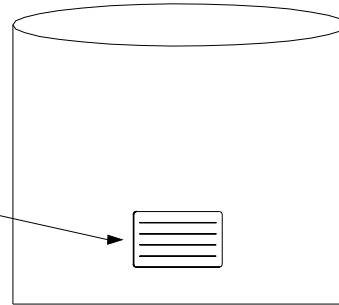

Outer Box Structure

Material : Paper(SW3B(B))

TYPE	SIZE (mm)		
	Ⓐ	Ⓑ	Ⓒ
7inch	245	220	102
	245	220	142

① SIDE

RANK: XXXX
 QUANTITY: XXXX
 LOT NUMBER: XXXXXXXXXXXX
 PART NUMBER: XXXXXXXX
 SEOUL SEMICONDUCTOR CO., LTD.

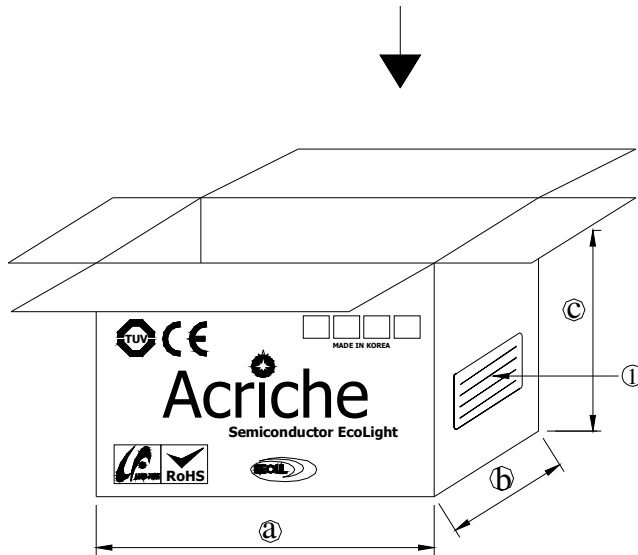

11. Soldering

(1) Lead Solder

Lead Solder	
Pre-heat	120~150 °C
Pre-heat time	120 sec. Max.
Peak-Temperature	240 °C Max.
Soldering time Condition	10 sec. Max.

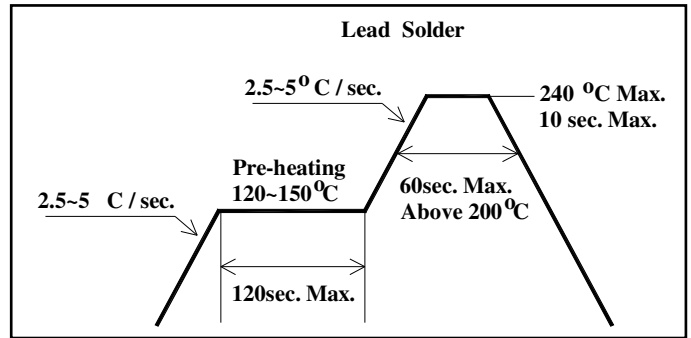

(2) Lead-Free Solder

Lead Free Solder	
Pre-heat	150~200 °C
Pre-heat time	120 sec. Max.
Peak-Temperature	260 °C Max.
Soldering time Condition	10 sec. Max.

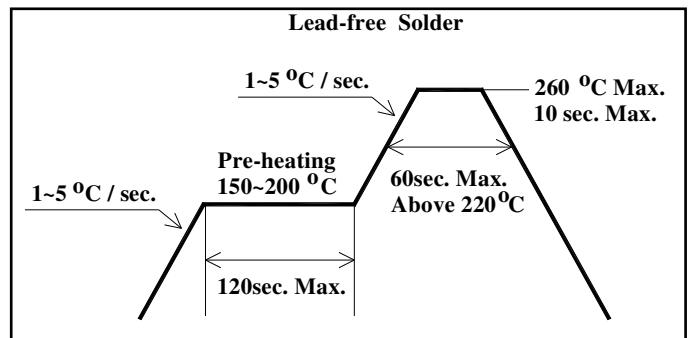

(3) Hand Soldering conditions

Do not exceed 4 seconds at maximum 315°C under soldering iron.

(4) The encapsulated material of the LEDs is silicone.

Precautions should be taken to avoid the strong pressure on the encapsulated part.

So when using the chip mounter,

the picking up nozzle that does not affect the silicone resin should be used.

(5) It is recommended that the customer use the nitrogen reflow method.

(6) Repairing should not be done after the LEDs have been soldered.

(7) Reflow soldering should not be done more than two times.

In the case of more than 24 hours passed soldering after first, LEDs will be damaged.

[Note] In case that the soldered products are reused in soldering process, we don't guarantee the products.

September 2011

www.seoulsemicon.com

SSC- QP- 7- 07- 24 (Rev.00)

12. Precaution for use

1) Storage

In order to avoid the absorption of moisture, it is recommended to store in a dry box (or a desiccator) with a desiccant. Otherwise, to store them in the following environment is recommended.

Temperature : 5°C ~30°C Humidity : maximum 70%RH

2) Attention after open.

LED is correspond to SMD, when LED be soldered dip, interfacial separation may affect the light transmission efficiency, causing the light intensity to drop. Attention in followed;

a. After opened and mounted the soldering shall be quickly.

b. Keeping of a fraction

Temperature : 5 ~ 40°C Humidity : less than 30%

3) In the case of more than 1 week passed after opening or change color of indicator on desiccant, components shall be dried 10-12hr. at 60± 5°C.

4) Silver plating might be tarnished in the environment that contains corrosive gases and materials. Also any product that has tarnished lead might be decreased the solder-ability and optical-electrical properties compare to normal ones.

Please do not expose the product in the corrosive environment during the storage.

5) Any mechanical force or any excess vibration shall not be accepted to apply during cooling process to normal temperature after soldering.

6) Quick cooling shall be avoided.

7) Components shall not be mounted on warped direction of PCB.

8) Anti radioactive ray design is not considered for the products.

9) This device should not be used in any type of fluid such as water, oil, organic solvent etc. When washing is required, IPA should be used.

10) When the LEDs are illuminating, operating current should be decided after considering the ambient maximum temperature.

11) The LEDs must be soldered within seven days after opening the moisture-proof packing.

12) Repack unused products with anti-moisture packing, fold to close any opening and then store in a dry place.

13) The appearance and specifications of the product may be modified for improvement without notice.

13. Handling of Silicone Resin LEDs

1) During processing, mechanical stress on the surface should be minimized as much as possible. Sharp objects of all types should not be used to pierce the sealing compound.



2) In general, LEDs should only be handled from the side. By the way, this also applies to LEDs without a silicone sealant, since the surface can also become scratched.

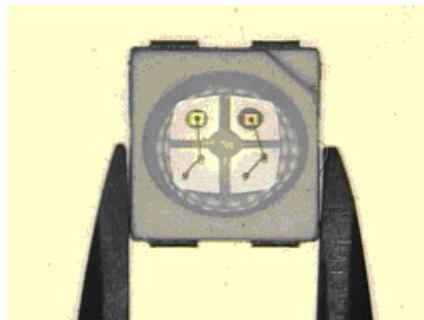

3) When populating boards in SMT production, there are basically no restrictions regarding the form of the pick and place nozzle, except that mechanical pressure on the surface of the resin must be prevented. This is assured by choosing a pick and place nozzle which is larger than the LED's reflector area.

4) Silicone differs from materials conventionally used for the manufacturing of LEDs. These conditions must be considered during the handling of such devices. Compared to standard encapsulants, silicone is generally softer, and the surface is more likely to attract dust.

As mentioned previously, the increased sensitivity to dust requires special care during processing. In cases where a minimal level of dirt and dust particles cannot be guaranteed, a suitable cleaning solution must be applied to the surface after the soldering of components.

5) SSC suggests using isopropyl alcohol for cleaning. In case other solvents are used, it must be assured that these solvents do not dissolve the package or resin. Ultrasonic cleaning is not recommended. Ultrasonic cleaning may cause damage to the LED.

6) Please do not mold this product into another resin (epoxy, urethane, etc) and do not handle this product with acid or sulfur material in sealed space.

Компания «Life Electronics» занимается поставками электронных компонентов импортного и отечественного производства от производителей и со складов крупных дистрибьюторов Европы, Америки и Азии.

С конца 2013 года компания активно расширяет линейку поставок компонентов по направлению коаксиальный кабель, кварцевые генераторы и конденсаторы (керамические, пленочные, электролитические), за счёт заключения дистрибьюторских договоров

Мы предлагаем:

- Конкурентоспособные цены и скидки постоянным клиентам.
- Специальные условия для постоянных клиентов.
- Подбор аналогов.
- Поставку компонентов в любых объемах, удовлетворяющих вашим потребностям.
- Приемлемые сроки поставки, возможна ускоренная поставка.
- Доставку товара в любую точку России и стран СНГ.
- Комплексную поставку.
- Работу по проектам и поставку образцов.
- Формирование склада под заказчика.
- Сертификаты соответствия на поставляемую продукцию (по желанию клиента).
- Тестирование поставляемой продукции.
- Поставку компонентов, требующих военную и космическую приемку.
- Входной контроль качества.
- Наличие сертификата ISO.

В составе нашей компании организован Конструкторский отдел, призванный помогать разработчикам, и инженерам.

Конструкторский отдел помогает осуществить:

- Регистрацию проекта у производителя компонентов.
- Техническую поддержку проекта.
- Защиту от снятия компонента с производства.
- Оценку стоимости проекта по компонентам.
- Изготовление тестовой платы монтаж и пусконаладочные работы.



Тел: +7 (812) 336 43 04 (многоканальный)
Email: org@lifeelectronics.ru