

Common Mode Filters

For automotive power line

ACM-V series

Type: **ACM4520V**
 ACM70V
 ACM90V
 ACM12V

Issue date: February 2013

- All specifications are subject to change without notice.
 - Conformity to RoHS Directive: This means that, in conformity with EU Directive 2002/95/EC, lead, cadmium, mercury, hexavalent chromium, and specific bromine-based flame retardants, PBB and PBDE, have not been used, except for exempted applications.
-

Common Mode Filters For Power Line

Conformity to RoHS Directive

ACM Series ACM4520V

FEATURES

- Several large current products are prepared to correspond to the various applications.
- Low profile and compact shape, it is suited for surface mounting.
- It shows high common mode impedance despite of its compact shape.

APPLICATIONS

Common mode noise countermeasures for DC power lines of electronic control equipment, multi-media equipment for automotives and various electronic equipment power supply lines.

TEMPERATURE RANGES

Operating	-40 to +125°C
Storage(After mount)	-40 to +125°C

PACKAGING STYLE AND QUANTITIES

Packaging style	Reel	Quantity
Taping	ø180mm	800 pieces/reel
	ø330mm	2500 pieces/reel

PRODUCT IDENTIFICATION

ACM	4520	V	-	901	-	2P	-	T	00
(1)	(2)	(3)	(4)	(5)	(6)	(7)			

- (1) Series name
- (2) Dimensions W×T
4520: 4.5×2.0mm
- (3) Product identification number
- (4) Impedance [at 100MHz]
901: 900Ω
- (5) Numbers of lines
2P: 2-line
- (6) Packaging style
T: ø180mm reel taping
TL: ø330mm reel taping
- (7) TDK internal code

RECOMMENDED SOLDERING CONDITIONS

RECOMMENDED TEMPERATURE PROFILE FOR LEAD-FREE SOLDER

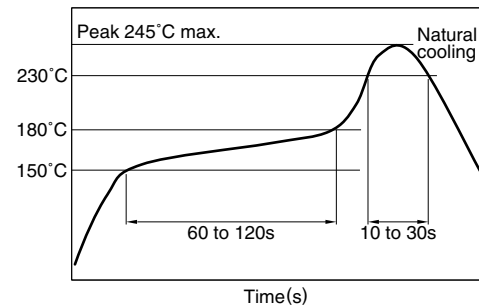

REFLOW PROFILE FOR SOLDER HEAT RESISTANCE

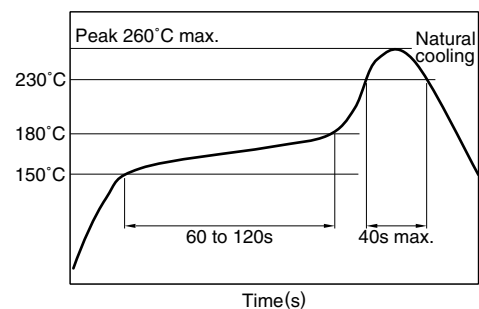

• Conformity to RoHS Directive: This means that, in conformity with EU Directive 2002/95/EC, lead, cadmium, mercury, hexavalent chromium, and specific bromine-based flame retardants, PBB and PBDE, have not been used, except for exempted applications.

• All specifications are subject to change without notice.

SHAPES AND DIMENSIONS

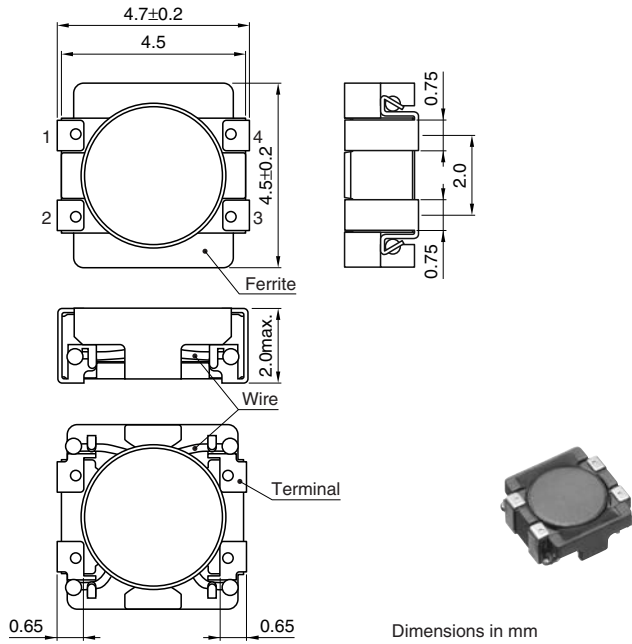

CIRCUIT DIAGRAM

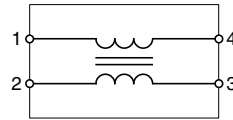

• No polarity

RECOMMENDED PC BOARD PATTERN

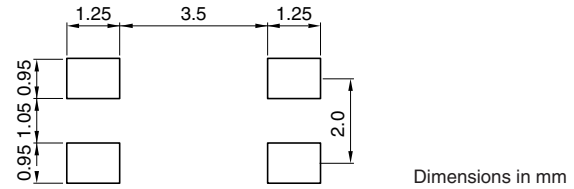

ELECTRICAL CHARACTERISTICS

Part No.	Common mode impedance (Ω) [at 100MHz]		DC resistance (Ω) max. [1 line]	Rated current I_{dc} (A) max. 125°C	Rated voltage E_{dc} (V) max.	Insulation resistance (M Ω) min.
	min.	typ.				
ACM4520V-231-2P	180	230	0.05	1.5	50	10
ACM4520V-421-2P	300	420	0.055	1.4	50	10
ACM4520V-901-2P	650	900	0.06	1.2	50	10
ACM4520V-142-2P	1000	1400	0.08	1.0	50	10

TYPICAL ELECTRICAL CHARACTERISTICS IMPEDANCE vs. FREQUENCY CHARACTERISTICS

ACM4520V-231-2P

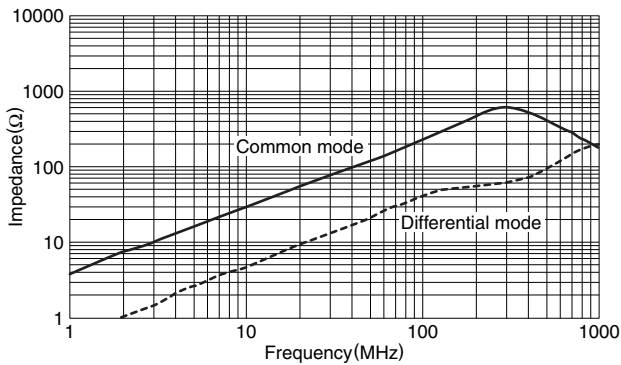

ACM4520V-421-2P

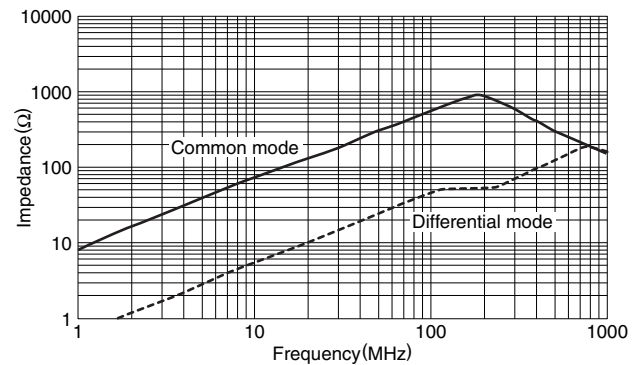

ACM4520V-901-2P

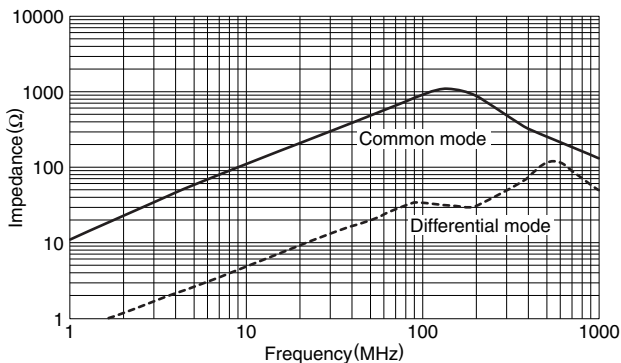

ACM4520V-142-2P

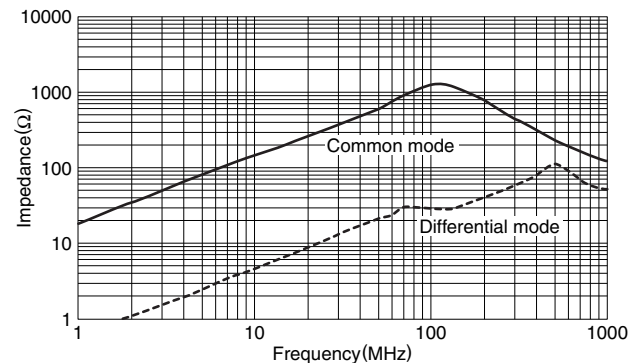

• All specifications are subject to change without notice.

Common Mode Filters For Automotive Power Line

Conformity to RoHS Directive

ACM-V Series ACM70V, ACM90V, ACM12V

FEATURES

- Have achieved miniaturization while keeping characteristics by adoption of exclusive square type closed magnetic cores.
- Due to the low profile design, it is suitable for surface mount.
- High impedance characteristic has been achieved a superior effect for common mode noise suppression.
- This products have serialized a large current product up to 8A corresponding for various DC power lines.
- Operating temperature range has covered widely from -40 to +125°C.

APPLICATIONS

Common mode noise countermeasures for DC power lines of electronic control equipment, multi-media equipment for automobiles and various electronic equipment power supply lines.

TEMPERATURE RANGES

Operating	-40 to +125°C
Storage(After mount)	-40 to +125°C

PACKAGING STYLE AND QUANTITIES

Packaging style	Type	Quantity
Taping	ACM70V	1500 pieces/reel
	ACM90V	800 pieces/reel
	ACM12V	500 pieces/reel

PRODUCT IDENTIFICATION

ACM 90V - 701 - 2PL - TL - □□
(1) (2) (3) (4) (5) (6)

- (1) Series name
- (2) Dimensional code
- (3) Impedance [at 100MHz]
701: 700Ω
- (4) Numbers of lines
2PL: 2-line
- (5) Packaging style
TL: ø330mm reel taping
- (6) TDK internal code

RECOMMENDED SOLDERING CONDITIONS RECOMMENDED TEMPERATURE PROFILE FOR LEAD-FREE SOLDER

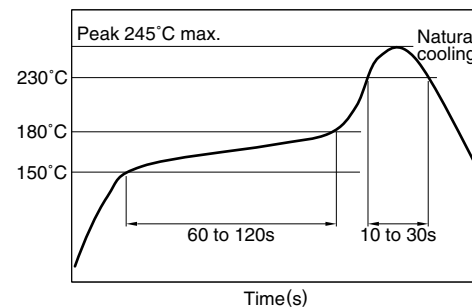

REFLOW PROFILE FOR SOLDER HEAT RESISTANCE

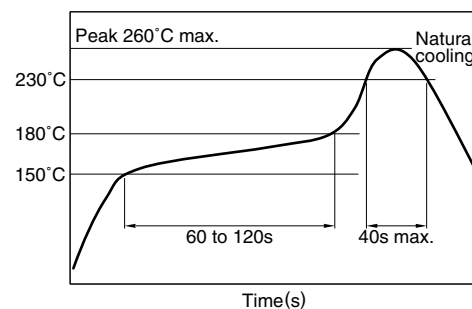

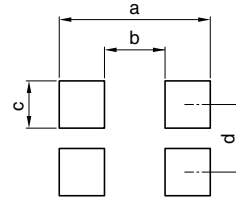
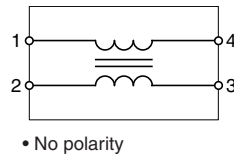
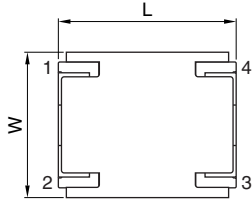
SHAPES AND DIMENSIONS/CIRCUIT DIAGRAM/RECOMMENDED PC BOARD PATTERN

Dimensions in mm

Type	a	b	c	d
ACM70V	9.0	4.0	1.5	3.0
ACM90V	11.0	6.0	1.5	3.5
ACM12V	14.0	7.4	2.7	5.2

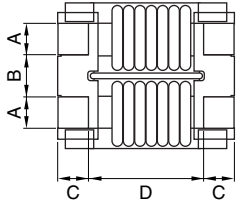
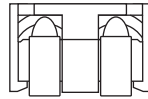
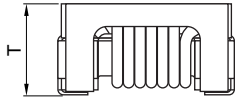

Coplanarity: 0.1max.

Dimensions in mm

Type	L	W	T	A	B	C	D	Weight
ACM70V	7.0±0.2	6.0±0.2	3.5max.	1.5±0.2	1.5±0.2	1.5±0.2	4.0typ.	0.35g
ACM90V	9.0±0.2	7.0±0.2	4.5max.	1.5±0.2	2.0±0.2	1.5±0.2	6.0typ.	0.82g
ACM12V	12.0±0.3	11.0±0.3	6.0max.	2.7±0.2	2.5±0.2	2.3±0.2	7.4typ.	2.30g

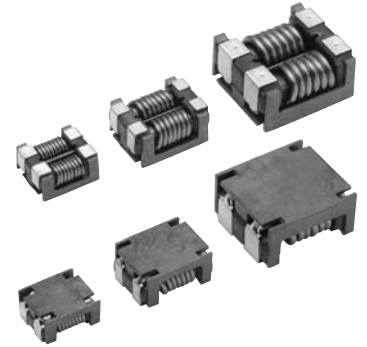
ELECTRICAL CHARACTERISTICS

Part No.	Common mode impedance (Ω)typ.[at 100MHz]	DC resistance (mΩ)max.	Rated current Idc (A)max.	Rated voltage Edc (V)max.	Insulation resistance (MΩ)min.
ACM70V-701-2PL-TL	700	15	4.0	80	10
ACM90V-701-2PL-TL	700	10	5.0	80	10
ACM12V-701-2PL-TL	700	6	8.0	80	10

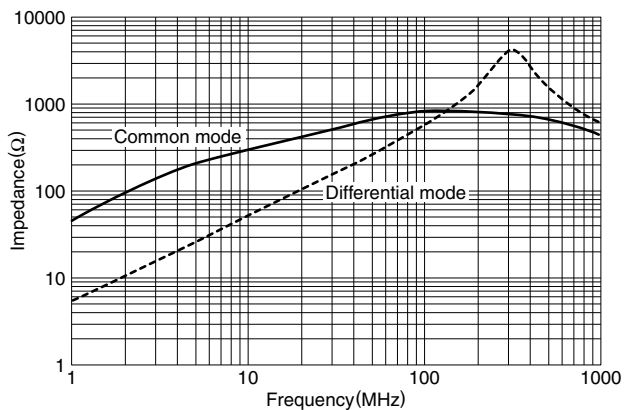
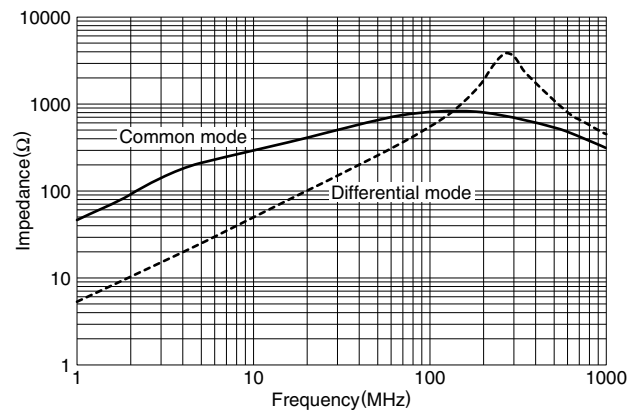
TYPICAL ELECTRICAL CHARACTERISTICS
IMPEDANCE vs. FREQUENCY CHARACTERISTICS
ACM70V-701-2PL

ACM90V-701-2PL

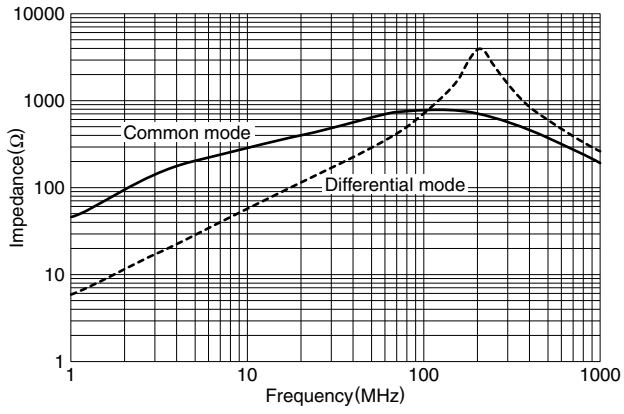
TYPICAL ELECTRICAL CHARACTERISTICS
IMPEDANCE vs. FREQUENCY CHARACTERISTICS
ACM12V-701-2PL



Компания «Life Electronics» занимается поставками электронных компонентов импортного и отечественного производства от производителей и со складов крупных дистрибьюторов Европы, Америки и Азии.

С конца 2013 года компания активно расширяет линейку поставок компонентов по направлению коаксиальный кабель, кварцевые генераторы и конденсаторы (керамические, пленочные, электролитические), за счёт заключения дистрибьюторских договоров

Мы предлагаем:

- Конкурентоспособные цены и скидки постоянным клиентам.
- Специальные условия для постоянных клиентов.
- Подбор аналогов.
- Поставку компонентов в любых объемах, удовлетворяющих вашим потребностям.
- Приемлемые сроки поставки, возможна ускоренная поставка.
- Доставку товара в любую точку России и стран СНГ.
- Комплексную поставку.
- Работу по проектам и поставку образцов.
- Формирование склада под заказчика.
- Сертификаты соответствия на поставляемую продукцию (по желанию клиента).
- Тестирование поставляемой продукции.
- Поставку компонентов, требующих военную и космическую приемку.
- Входной контроль качества.
- Наличие сертификата ISO.

В составе нашей компании организован Конструкторский отдел, призванный помогать разработчикам, и инженерам.

Конструкторский отдел помогает осуществить:

- Регистрацию проекта у производителя компонентов.
- Техническую поддержку проекта.
- Защиту от снятия компонента с производства.
- Оценку стоимости проекта по компонентам.
- Изготовление тестовой платы монтаж и пусконаладочные работы.



Тел: +7 (812) 336 43 04 (многоканальный)

Email: org@lifeelectronics.ru