

IRIS-SCREW

~5° real spot beam with holder optimized for CREE XP-E. Assembly with screws.

TECHNICAL SPECIFICATIONS:

Dimensions	Ø 38.0 mm
Height	26.9 mm
Fastening	glue, pin, screw
ROHS compliant	yes ⓘ

MATERIAL SPECIFICATIONS:

Component	Type	Material	Colour	Finish
IRIS	Single lens	PMMA	clear	
IRIS-XP-HLD	Holder	PC	black	

ORDERING INFORMATION:

Component		Qty in box	MOQ	MPQ	Box weight (kg)
FCN12076_IRIS-SCREW	Single lens	360		90	0.0
» Box size:					



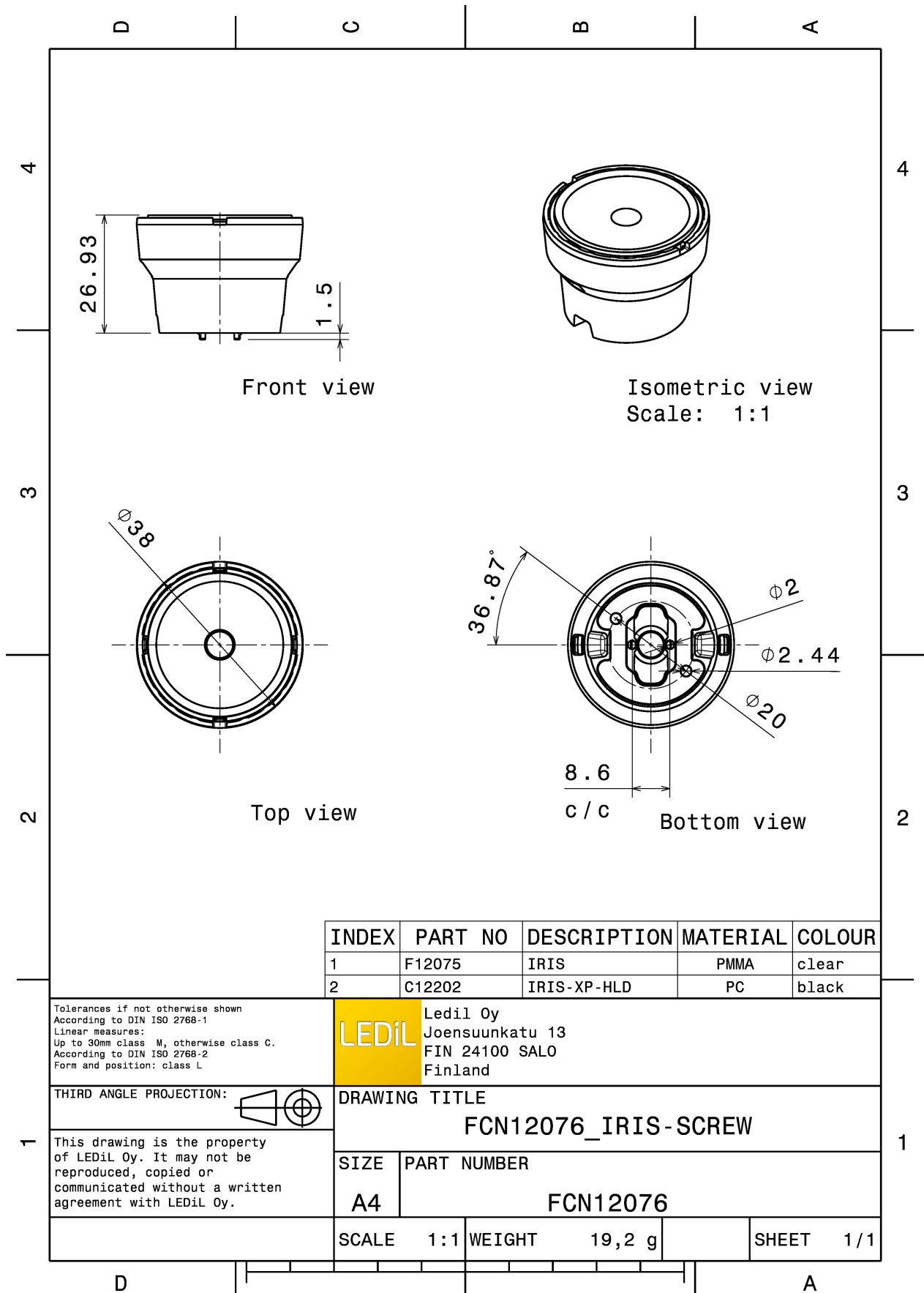

PHOTOMETRIC DATA (MEASURED):

CREE 

LED XHP35 HI
FWHM 7.6°
Efficiency 90 %
Peak intensity 35.9 cd/lm
LEDs/each optic 1
Light colour White
Required components:



CREE 

LED XP-E
FWHM 4.0°
Efficiency 93 %
Peak intensity 87.4 cd/lm
LEDs/each optic 1
Light colour White
Required components:

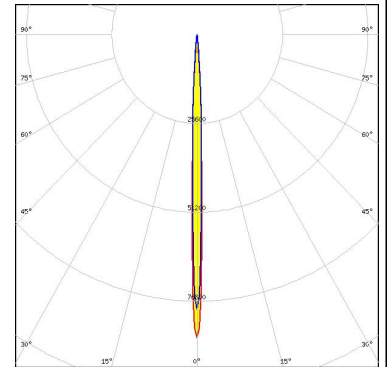

CREE 

LED XP-G
FWHM 5.0°
Efficiency 93 %
Peak intensity 52 cd/lm
LEDs/each optic 1
Light colour White
Required components:

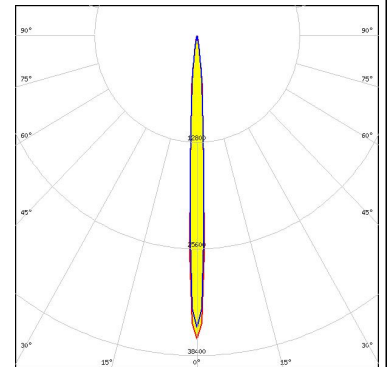
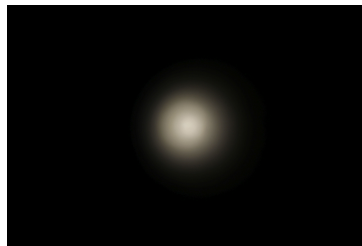

CREE 

LED XP-L HD
FWHM 8.5°
Efficiency 93 %
Peak intensity 22.2 cd/lm
LEDs/each optic 1
Light colour White
Required components:

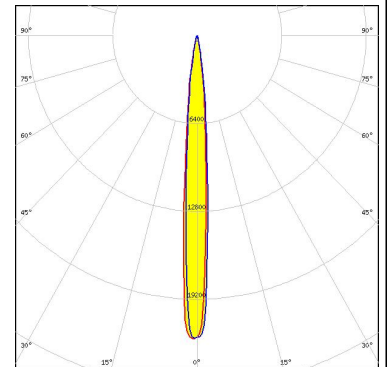

PHOTOMETRIC DATA (MEASURED):

LUMILEDS

LED LUXEON Rebel
 FWHM 5.0°
 Efficiency 93 %
 Peak intensity 75.6 cd/Im
 LEDs/each optic 1
 Light colour White
 Required components:

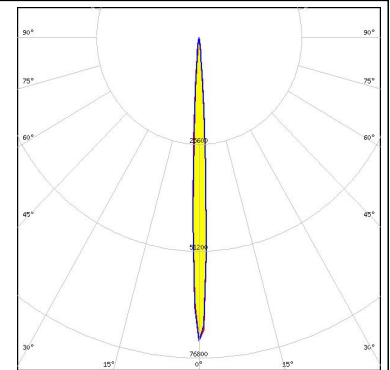

LUMILEDS

LED LUXEON Rebel ES
 FWHM 7.0°
 Efficiency 93 %
 Peak intensity 38.5 cd/Im
 LEDs/each optic 1
 Light colour White
 Required components:

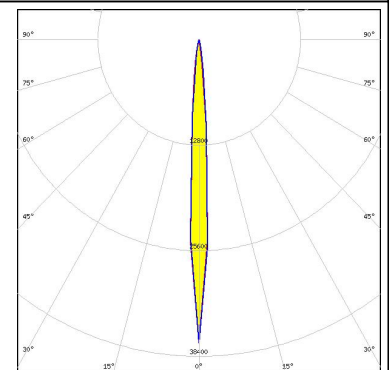

LUMILEDS

LED LUXEON V
 FWHM 9.0°
 Efficiency 92 %
 Peak intensity 20.6 cd/Im
 LEDs/each optic 1
 Light colour White
 Required components:

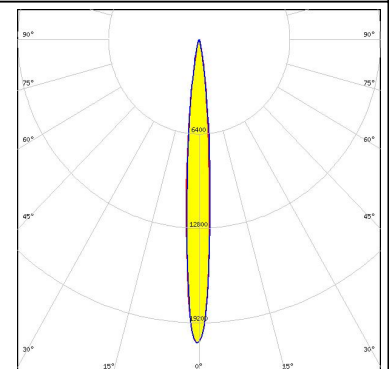
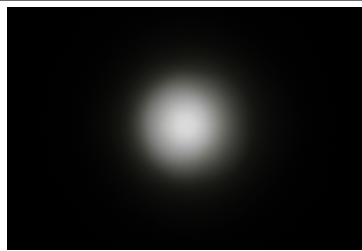



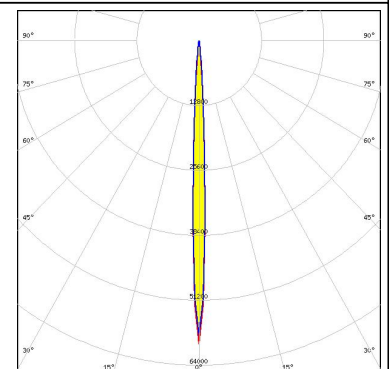

NICHIA

LED NCSxx19A
 FWHM 5.0°
 Efficiency %
 LEDs/each optic 1
 Light colour White
 Required components:

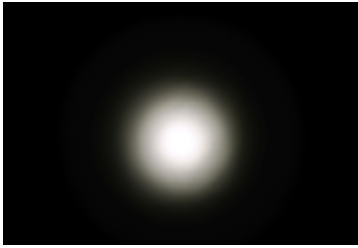
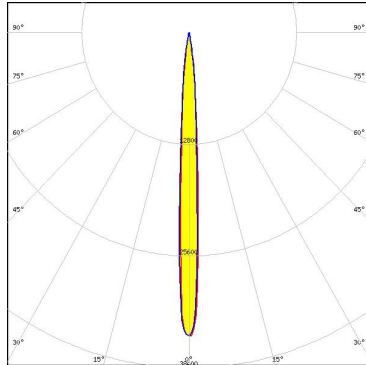

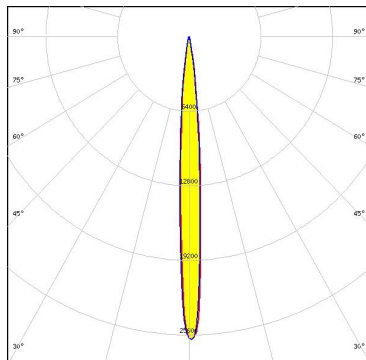
PHOTOMETRIC DATA (MEASURED):

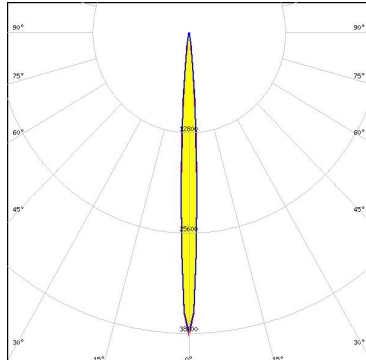
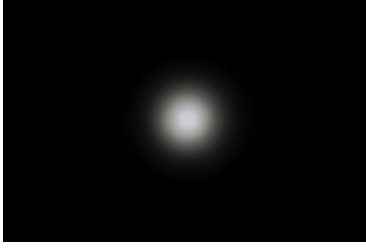
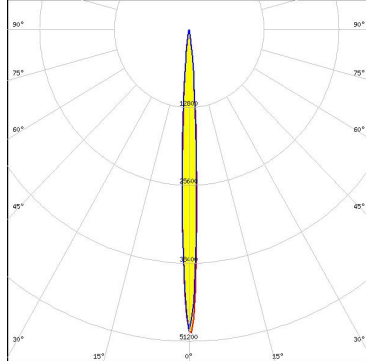
<p>NICHIA</p> <p>LED NVSW219F FWHM 7.0° Efficiency 93 % Peak intensity 34.8 cd/lm LEDs/each optic 1 Light colour White Required components:</p>		
<p>NICHIA</p> <p>LED NVSW3x9A FWHM 8.0° Efficiency 90 % Peak intensity 26.1 cd/lm LEDs/each optic 1 Light colour White Required components:</p>		
<p>NICHIA</p> <p>LED NVSxx19A FWHM 6.0° Efficiency 93 % Peak intensity 38.7 cd/lm LEDs/each optic 1 Light colour White Required components:</p>		
<p>OSRAM <small>Opto Semiconductors</small></p> <p>LED OSLOM Square CSSRM2/CSSRM3 FWHM 6.0° Efficiency 94 % Peak intensity 49.9 cd/lm LEDs/each optic 1 Light colour White Required components:</p>		

PHOTOMETRIC DATA (MEASURED):

OSRAM
Opto Semiconductors

LED OSLON SSL 150
FWHM 4.0°
Efficiency 93 %
Peak intensity 76.8 cd/lm
LEDs/each optic 1
Light colour White
Required components:

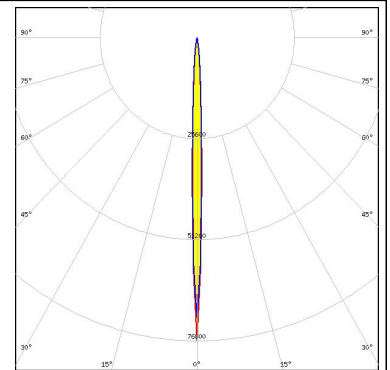

OSRAM
Opto Semiconductors

LED OSLON SSL 80
FWHM 4.0°
Efficiency 90 %
Peak intensity 89 cd/lm
LEDs/each optic 1
Light colour White
Required components:

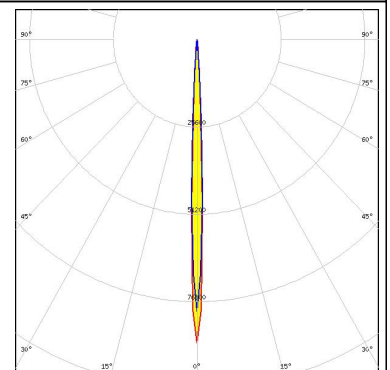

SEOL

SEOUL SEMICONDUCTOR

LED Z5M3
FWHM 7.0°
Efficiency 92 %
Peak intensity 3.1 cd/lm
LEDs/each optic 1
Light colour White
Required components:

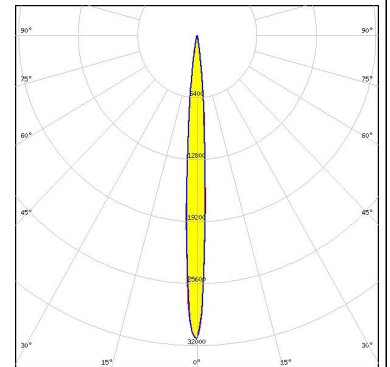
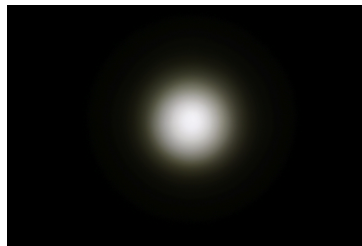

PHOTOMETRIC DATA (SIMULATED):



LED XP-E2
 FWHM 5.9°
 Efficiency 94 %
 Peak intensity 56.6 cd/lm
 LEDs/each optic 1
 Light colour White
 Required components:

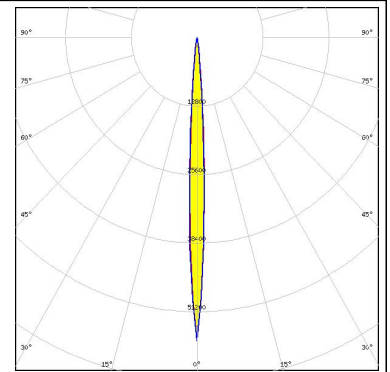

LED XP-G2
 FWHM 6.7°
 Efficiency 94 %
 Peak intensity 44.3 cd/lm
 LEDs/each optic 1
 Light colour White
 Required components:

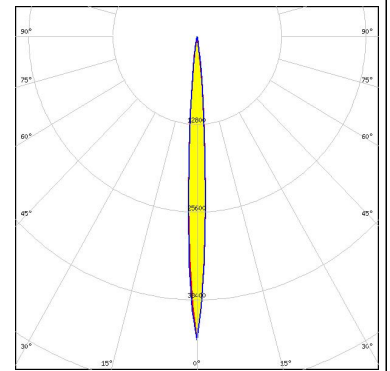

LED XP-G2 HE
 FWHM 8.0°
 Efficiency 90 %
 Peak intensity 28.6 cd/lm
 LEDs/each optic 1
 Light colour White
 Required components:

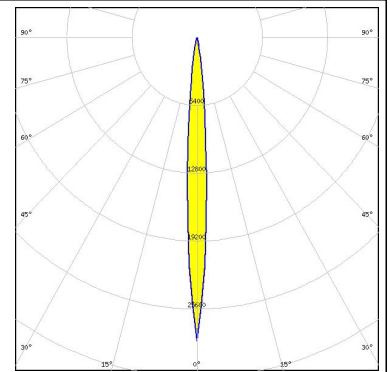

LED XP-G3
 FWHM 7.5°
 Efficiency 91 %
 Peak intensity 29.6 cd/lm
 LEDs/each optic 1
 Light colour White
 Required components:

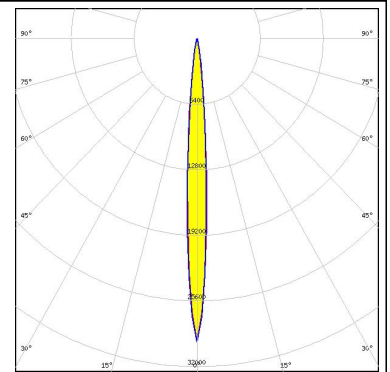

PHOTOMETRIC DATA (SIMULATED):



LED XQ-E HD
 FWHM 5.0°
 Efficiency 93 %
 Peak intensity 80 cd/lm
 LEDs/each optic 1
 Light colour White
 Required components:



LED XQ-E HD
 FWHM 5.5°
 Efficiency 94 %
 Peak intensity 74.2 cd/lm
 LEDs/each optic 1
 Light colour White
 Required components:

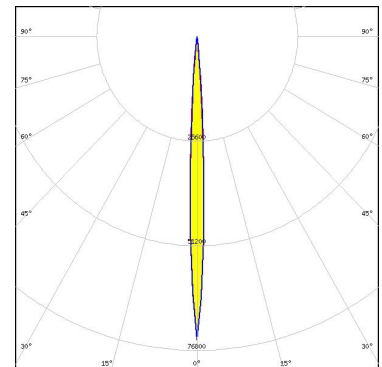

LED OSCONIQ P 3737 (2W version)
 FWHM 6.5°
 Efficiency 94 %
 Peak intensity 46.4 cd/lm
 LEDs/each optic 1
 Light colour White
 Required components:

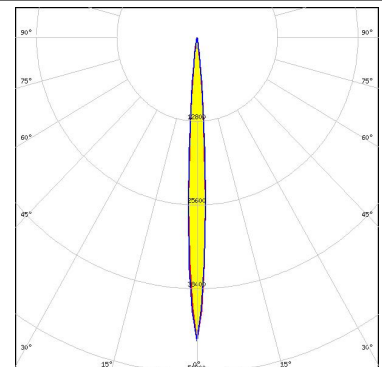

LED OSCONIQ P 3737 (3W version)
 FWHM 9.0°
 Efficiency 94 %
 Peak intensity 25.5 cd/lm
 LEDs/each optic 1
 Light colour White
 Required components:

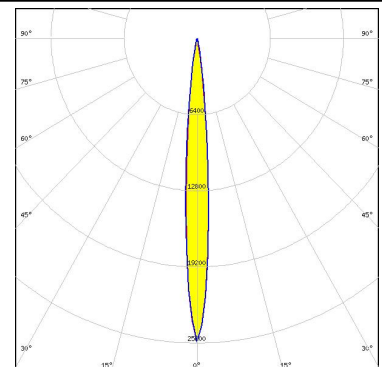

PHOTOMETRIC DATA (SIMULATED):

SAMSUNG

LED LH351B
 FWHM 7.4°
 Efficiency 94 %
 Peak intensity 33.9 cd/lm
 LEDs/each optic 1
 Light colour White
 Required components:

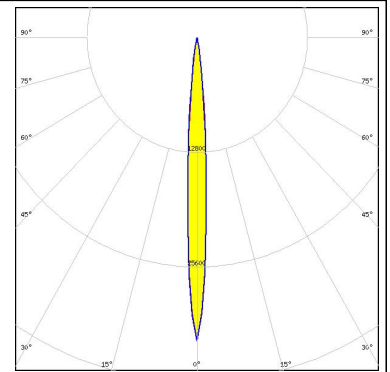

SAMSUNG

LED LH351D
 FWHM 9.2°
 Efficiency 90 %
 Peak intensity 20.6 cd/lm
 LEDs/each optic 1
 Light colour White
 Required components:

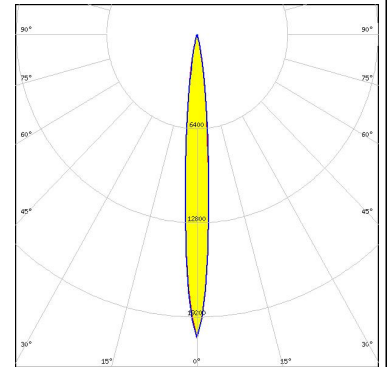

SAMSUNG

LED LM101B
 FWHM 6.0°
 Efficiency 92 %
 Peak intensity 58.9 cd/lm
 LEDs/each optic 1
 Light colour White
 Required components:

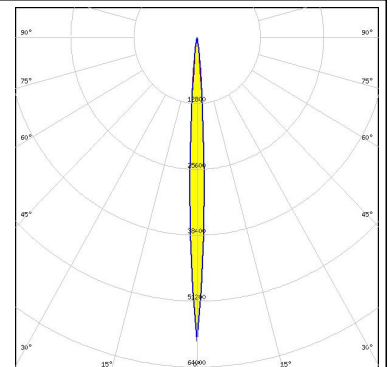

SEOUL SEMICONDUCTOR

LED Z8Y22P
 FWHM 8.0°
 Efficiency 98 %
 Peak intensity 29.9 cd/lm
 LEDs/each optic 1
 Light colour White
 Required components:

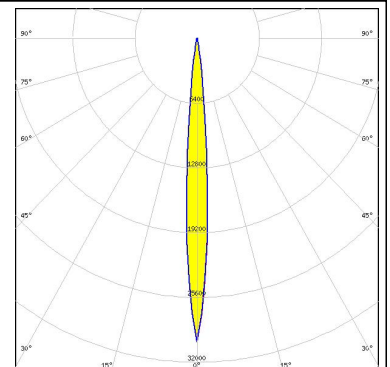

GENERAL INFORMATION:

NOTE: The typical beam angle will be changed by different color, chip size and chip position tolerance. The typical total beam angle is the full angle measured where the luminous intensity is half of the peak value.

MATERIALS:

As part of our continuous research and improvement processes, and to ensure the best possible quality and availability of our products, LEDiL reserves the right to change material grades without notice.

PRODUCT DATA USER AGREEMENT AND DISCLAIMER:

The measured data in the provided downloadable LEDiL Product Datasheets and Mechanical 2D-Drawings is rounded and provided as reference for planning. LEDiL Oy's optical specifications have been verified by conducting performance testing of the products in accordance with the company's quality system. The reported data are averaged results of multiple measurements with typical variation. LEDiL Oy reserves the right to without prior notification make changes and improvements to its products.

LEDiL Oy assumes neither warranty, nor guarantee nor any other liability of any kind for the contents and correctness of the provided data. The provided data has been generated with highest diligence but the provided data may in reality not represent the complete possible variation range of all intrinsic parameters. Therefore, in certain cases a deviation from the provided data could occur.

LEDiL Oy reserves the right to undertake technical changes of its products without further notification which could lead to changes in the provided data. LEDiL Oy assumes no liability of any kind for the possible deviation from any provided data or any other damage resulting from the usage of the provided data.

The user agrees to this disclaimer and user agreement with the download or usage of the provided files.

LEDiL Oy

Joensuunkatu 13
FI-24240 SALO
Finland

LEDiL Inc.

228 West Page Street
Suite D
Sycamore IL 60178
USA

Local sales and technical support

[www.ledil.com/
where_to_buy](http://www.ledil.com/where_to_buy)

Shipping locations

Salo, Finland
Hong Kong, China

Distribution Partners

[www.ledil.com/
where_to_buy](http://www.ledil.com/where_to_buy)

Компания «Life Electronics» занимается поставками электронных компонентов импортного и отечественного производства от производителей и со складов крупных дистрибьюторов Европы, Америки и Азии.

С конца 2013 года компания активно расширяет линейку поставок компонентов по направлению коаксиальный кабель, кварцевые генераторы и конденсаторы (керамические, пленочные, электролитические), за счёт заключения дистрибьюторских договоров

Мы предлагаем:

- Конкурентоспособные цены и скидки постоянным клиентам.
- Специальные условия для постоянных клиентов.
- Подбор аналогов.
- Поставку компонентов в любых объемах, удовлетворяющих вашим потребностям.
- Приемлемые сроки поставки, возможна ускоренная поставка.
- Доставку товара в любую точку России и стран СНГ.
- Комплексную поставку.
- Работу по проектам и поставку образцов.
- Формирование склада под заказчика.
- Сертификаты соответствия на поставляемую продукцию (по желанию клиента).
- Тестирование поставляемой продукции.
- Поставку компонентов, требующих военную и космическую приемку.
- Входной контроль качества.
- Наличие сертификата ISO.

В составе нашей компании организован Конструкторский отдел, призванный помогать разработчикам, и инженерам.

Конструкторский отдел помогает осуществить:

- Регистрацию проекта у производителя компонентов.
- Техническую поддержку проекта.
- Защиту от снятия компонента с производства.
- Оценку стоимости проекта по компонентам.
- Изготовление тестовой платы монтаж и пусконаладочные работы.



Тел: +7 (812) 336 43 04 (многоканальный)

Email: org@lifeelectronics.ru