

Features

- Superior circuit protection
- Overcurrent and overvoltage protection
- Blocks surges up to rated limits
- High speed performance
- Small SMT package
- RoHS compliant*
- Agency recognition: ®

Applications

- Ethernet ports
- Protection modules and dongles
- Process control equipment
- Test and measurement equipment
- General electronics

TBU-DT Series - TBU® High Speed Protectors

General Information

The TBU-DT Series of Bourns® TBU® (Transient Blocking Unit) products are very low capacitance dual unidirectional high speed surge protection components designed to protect against faults caused by short circuits, AC power cross, induction and lightning surges.

The TBU-DT series is a unidirectional TBU® device; the TBU® protector will trip in less than 1 μ s when the current reaches the maximum value in one direction only, that is when Pin 1 is positive in voltage with respect to Pin 2, and Pin 4 is positive with respect to Pin 3. No current limiting exists in the opposite polarity, and the TBU® device appears as resistive in nature. The reverse current should not exceed the maximum trip current level of the TBU® device. An external diode may be used to prevent reverse current in DC biased applications.

The TBU® protector blocks surges and provides an effective barrier behind which sensitive electronics will not be exposed to large voltages or currents during surge events. After the surge, the TBU® device resets when the voltage across the TBU® device falls to the V_{reset} level. The TBU® device will automatically reset on lines which have no DC bias or have DC bias below V_{reset} (such as unpowered signal lines).

The TBU® device is provided in a surface mount DFN package and meets industry standard requirements such as RoHS and Pb Free solder reflow profiles.

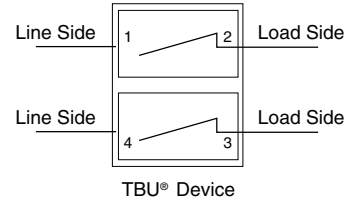

Agency Approval

Description	
UL	File Number: E315805

Absolute Maximum Ratings (@ $T_A = 25^\circ\text{C}$ Unless Otherwise Noted)

Symbol	Parameter	Part Number	Value	Unit
V_{imp}	Peak impulse voltage withstand with duration less than 10 ms	TBU-DT065-xxx-WH TBU-DT085-xxx-WH	650 850	V
V_{rms}	Continuous A.C. RMS voltage	TBU-DT065-xxx-WH TBU-DT085-xxx-WH	300 425	V
T_{op}	Operating temperature range		-40 to +85	$^\circ\text{C}$
T_{stg}	Storage temperature range		-65 to +150	$^\circ\text{C}$

Electrical Characteristics (@ $T_A = 25^\circ\text{C}$ Unless Otherwise Noted)

Symbol	Parameter	Part Number	Min.	Typ.	Max.	Unit	
$I_{trigger}$	Current required for the device to go from operating state to protected state	TBU-DTxxx-100-WH TBU-DTxxx-200-WH TBU-DTxxx-300-WH TBU-DTxxx-500-WH	100 200 300 500	150 300 450 750	200 400 600 1000	mA	
R_{device}	Series resistance of the TBU® device	$V_{imp} = 650\text{ V } I_{trigger}(\text{min.}) = 100\text{ mA}$ $V_{imp} = 650\text{ V } I_{trigger}(\text{min.}) = 200\text{ mA}$ $V_{imp} = 650\text{ V } I_{trigger}(\text{min.}) = 300\text{ mA}$ $V_{imp} = 650\text{ V } I_{trigger}(\text{min.}) = 500\text{ mA}$ $V_{imp} = 850\text{ V } I_{trigger}(\text{min.}) = 100\text{ mA}$ $V_{imp} = 850\text{ V } I_{trigger}(\text{min.}) = 200\text{ mA}$ $V_{imp} = 850\text{ V } I_{trigger}(\text{min.}) = 300\text{ mA}$ $V_{imp} = 850\text{ V } I_{trigger}(\text{min.}) = 500\text{ mA}$	TBU-DT065-100-WH TBU-DT065-200-WH TBU-DT065-300-WH TBU-DT065-500-WH TBU-DT085-100-WH TBU-DT085-200-WH TBU-DT085-300-WH TBU-DT085-500-WH		8.5 5.6 4.6 4.0 10.3 7.4 6.5 5.8	10.0 6.6 5.6 4.8 12.1 8.7 7.7 6.9	Ω
R_{match}	Package resistance matching of the TBU® device #1 - TBU® device #2		-0.5		+0.5	Ω	
t_{block}	Time for the device to go from normal operating state to protected state				1	μs	
I_Q	Current through the triggered TBU® device with 50 Vdc circuit voltage		0.25	0.50	1.00	mA	
V_{reset}	Voltage below which the triggered TBU® device will transition to normal operating state		12	16	20	V	
$R_{th(j-l)}$	Junction to package pads - FR4 using recommended pad layout			116		$^\circ\text{C/W}$	
$R_{th(j-s)}$	Junction to package pads - FR4 using heat sink on board (6 cm ²)			96		$^\circ\text{C/W}$	

*RoHS Directive 2002/95/EC Jan 27, 2003 including Annex.

Specifications are subject to change without notice.

Customers should verify actual device performance in their specific applications.

TBU-DT Series - TBU® High Speed Protectors

BOURNS®

Reference Application

The TBU® device can be used to protect against excessive voltage surges in transformer coupled equipment, as shown in the figure below. The TBU® protector prevents any surges from causing damage. An overvoltage protection device, such as an MOV or GDT, may be used to provide additional overvoltage protection if the surge voltage is likely to be above the maximum rating of the TBU® device.

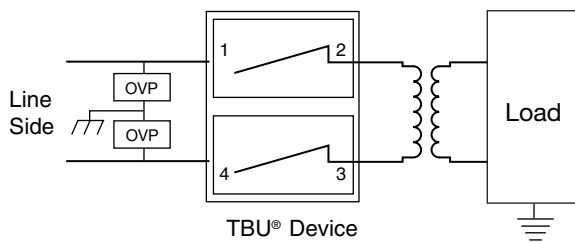

Basic TBU Operation

The TBU® device is a silicon-based, solid-state, resettable device which is placed in series with a signal path. The TBU® device operates in approximately 1 μ s - once line current exceeds the TBU® device's trigger current $I_{trigger}$. When operated, the TBU® device restricts line current to less than 1 mA typically. When operated, the TBU® device will block all system voltages and any other voltages including the surge up to rated limits.

After the surge, the TBU® device resets when the voltage across the TBU® device falls to the V_{reset} level. The TBU® device will automatically reset on lines which have no DC bias or have DC bias below V_{reset} (such as unpowered signal lines).

If the line has a normal DC bias above V_{reset} , the voltage across the TBU® device may not fall below V_{reset} after the surge. In such cases, special care needs to be taken to ensure that the TBU® device will reset, otherwise an automatic or manual power down will be required. Bourns application engineers can provide further assistance.

Performance Graphs

V-I Characteristic - TBU-DT085-300-WH (Pin 2-1 & Pin 3-4)

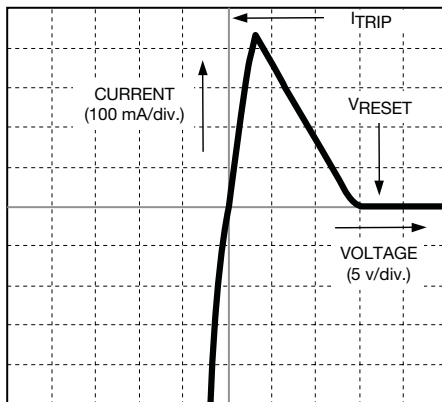

Typical Trigger Current vs. Temperature

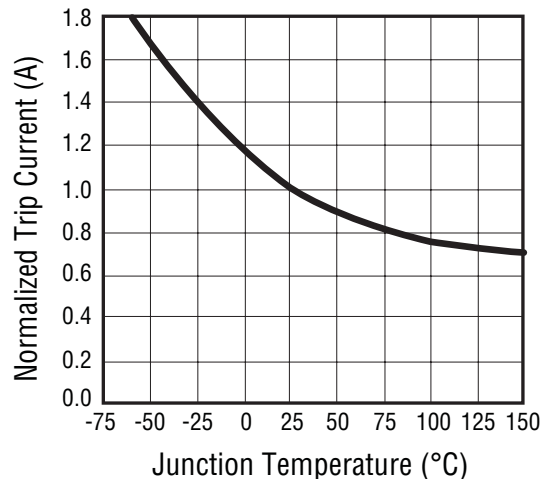

TBU-DT Series - TBU® High Speed Protectors

BOURNS®

Performance Graphs (Continued)

Power Derating Curve

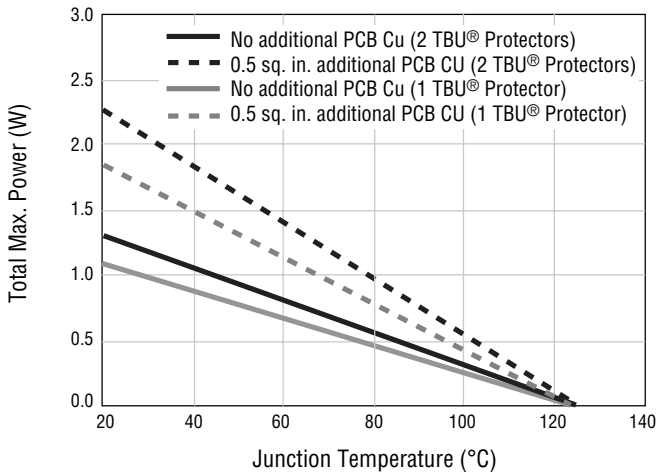

Typical Resistance vs. Temperature

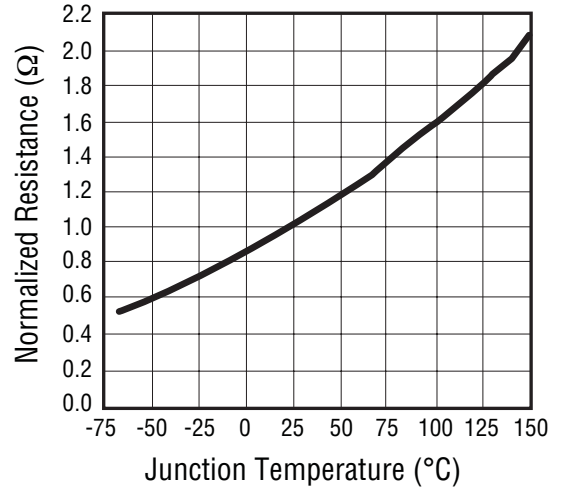

Reflow Profile

Profile Feature	Pb-Free Assembly
Average Ramp-Up Rate (T _{smax} to T _p)	3 °C/sec. max.
Preheat	
- Temperature Min. (T _{smin})	150 °C
- Temperature Max. (T _{smax})	200 °C
- Time (t _{smin} to t _{smax})	60-180 sec.
Time maintained above:	
- Temperature (T _L)	217 °C
- Time (t _L)	60-150 sec.
Peak/Classification Temperature (T _p)	260 °C
Time within 5 °C of Actual Peak Temp. (t _p)	20-40 sec.
Ramp-Down Rate	6 °C/sec. max.
Time 25 °C to Peak Temperature	8 min. max.



TBU-DT Series - TBU® High Speed Protectors

BOURNS®

Product Dimensions

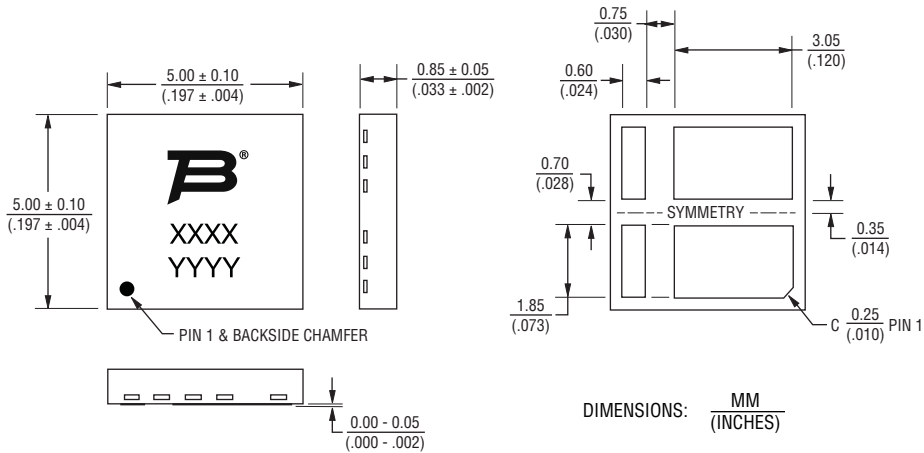

Recommended Pad Layout

TBU® protectors have matte-tin termination finish. The suggested layout should use Non-Solder Mask Define (NSMD). The recommended stencil thickness is 0.10-0.12 mm (.004-.005 in.) with a stencil opening size 0.025 mm (.0010 in.) less than the device pad size. As when heat sinking any power device, it is recommended that wherever possible, extra PCB copper area is allowed. For minimum parasitic capacitance, do not allow any signal, ground or power signals beneath any of the pads of the device.

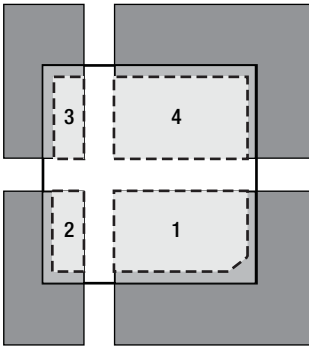

Pad Designation

Pad #	Pin Out
1	Line Side 1
2	Line Load 1
3	Line Load 2
4	Line Side 2

Dark grey areas show added PCB copper area for better thermal resistance.

Thermal Resistance vs. Additional PCB Cu Area

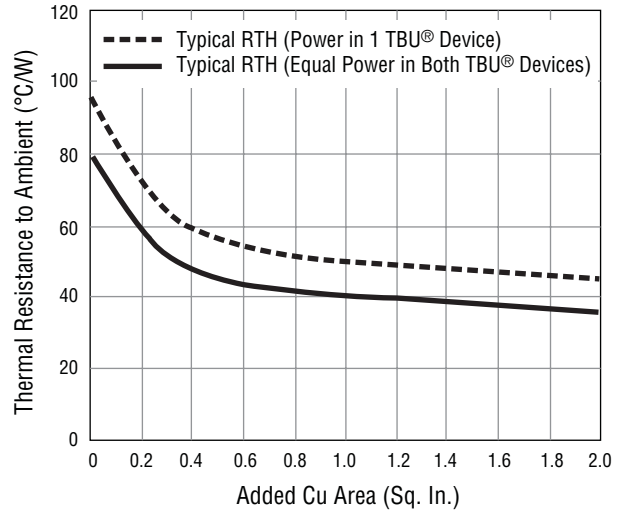

TBU-DT Series - TBU® High Speed Protectors

BOURNS®

How to Order



Typical Part Marking

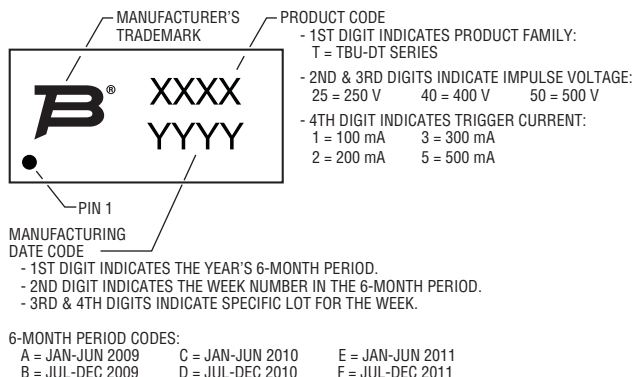

Packaging Specifications

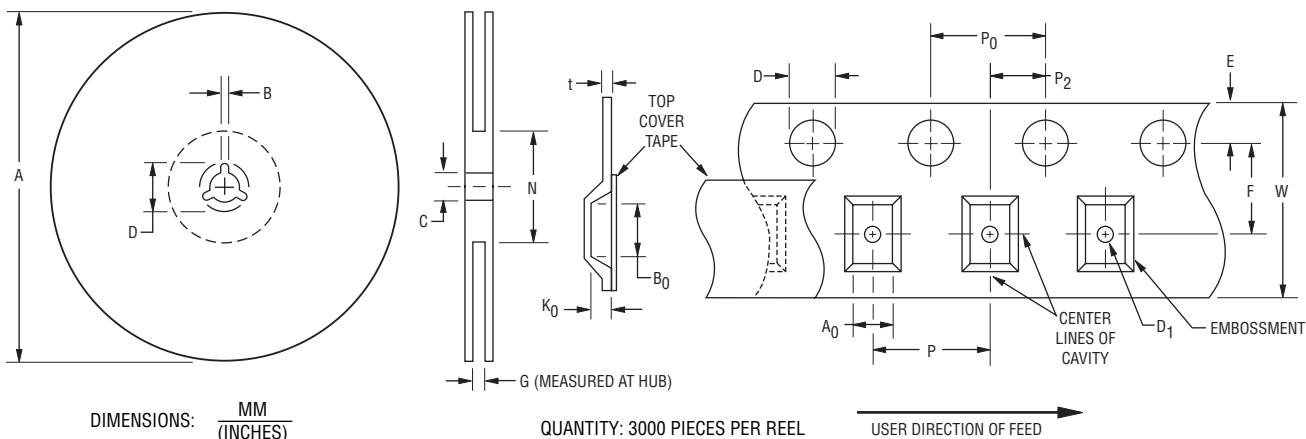

A		B		C		D		G	N
Min.	Max.	Min.	Max.	Min.	Max.	Min.	Max.	Ref.	Ref.
326	330	1.5	2.5	12.8	13.5	20.2	-	16.5	102
(12.835)	(13.002)	(.059)	(.098)	(.504)	(.531)	(.795)		(.650)	(4.016)

A ₀		B ₀		D		D ₁		E		F	
Min.	Max.	Min.	Max.	Min.	Max.	Min.	Max.	Min.	Max.	Min.	max.
5.4	5.6	5.4	5.6	1.5	1.6	1.5	-	1.65	1.85	7.4	7.6
(.212)	(.220)	(.212)	(.220)	(.059)	(.063)	(.059)		(.065)	(.073)	(.291)	(.299)
K ₀		P		P ₀		P ₂		t		W	
Min.	Max.	Min.	Max.	Min.	Max.	Min.	Max.	Min.	Max.	Min.	Max.
1.1	1.3	7.9	8.1	3.9	4.1	1.9	2.1	0.25	0.35	15.7	16.3
(.043)	(.051)	(.311)	(.319)	(.159)	(.161)	(.075)	(.083)	(.010)	(.014)	(.618)	(.642)

Asia-Pacific: Tel: +886-2 2562-4117 • Fax: +886-2 2562-4116

BOURNS®

Europe: Tel: +41-41 768 5555 • Fax: +41-41 768 5510

The Americas: Tel: +1-951 781-5500 • Fax: +1-951 781-5700

www.bourns.com

12/10

"TBU" is a registered trademark of Bourns, Inc. in the U.S., Taiwan and European Community.

Specifications are subject to change without notice.

Customers should verify actual device performance in their specific applications

Компания «Life Electronics» занимается поставками электронных компонентов импортного и отечественного производства от производителей и со складов крупных дистрибьюторов Европы, Америки и Азии.

С конца 2013 года компания активно расширяет линейку поставок компонентов по направлению коаксиальный кабель, кварцевые генераторы и конденсаторы (керамические, пленочные, электролитические), за счёт заключения дистрибьюторских договоров

Мы предлагаем:

- Конкуренспособные цены и скидки постоянным клиентам.
- Специальные условия для постоянных клиентов.
- Подбор аналогов.
- Поставку компонентов в любых объемах, удовлетворяющих вашим потребностям.
- Приемлемые сроки поставки, возможна ускоренная поставка.
- Доставку товара в любую точку России и стран СНГ.
- Комплексную поставку.
- Работу по проектам и поставку образцов.
- Формирование склада под заказчика.
- Сертификаты соответствия на поставляемую продукцию (по желанию клиента).
- Тестирование поставляемой продукции.
- Поставку компонентов, требующих военную и космическую приемку.
- Входной контроль качества.
- Наличие сертификата ISO.

В составе нашей компании организован Конструкторский отдел, призванный помогать разработчикам, и инженерам.

Конструкторский отдел помогает осуществить:

- Регистрацию проекта у производителя компонентов.
- Техническую поддержку проекта.
- Защиту от снятия компонента с производства.
- Оценку стоимости проекта по компонентам.
- Изготовление тестовой платы монтаж и пусконаладочные работы.



Тел: +7 (812) 336 43 04 (многоканальный)
Email: org@lifeelectronics.ru