

Dust-tight, Easy-to-Use, Push-operated Switches with Large Display Characters

- Simple push mechanism and large, easy-to-view numeric display make setting easy.
- Dust penetration prevented with seal for the display windows.

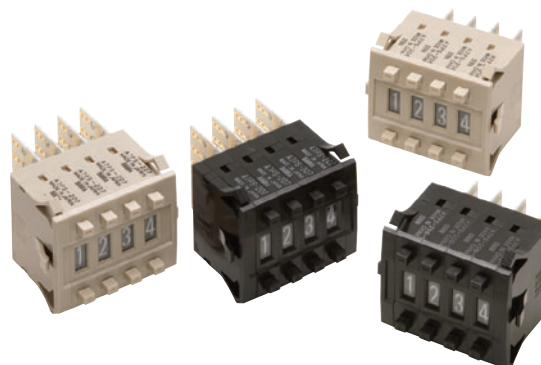

Ordering Information

Switches (Single Switch Units)

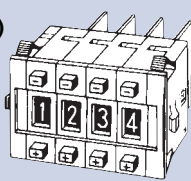
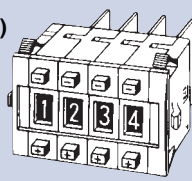
Model	A7PS		A7PH	
	Snap-in (front mounting)		Snap-in (front mounting)	
Classification (See note 1.)				
	Terminals	Solder terminals *1		
Color		Light gray	Black	Light gray
Output code number	Model			
03 (decimal code)	A7PS-203	A7PS-203-1	A7PH-203	A7PH-203-1
06 (binary coded decimal)	A7PS-206	A7PS-206-1	A7PH-206	A7PH-206-1
07 (binary coded decimal, with component-adding provision) *2	A7PS-207	A7PS-207-1	A7PH-207	A7PH-207-1
19 (decimal code, with component-adding provision)	A7PS-219	A7PS-219-1	A7PH-219	---
54 (binary coded hexadecimal)	A7PS-254	A7PS-254-1	A7PH-254	A7PH-254-1
55 (binary coded hexadecimal, with component adding provision) *2	A7PS-255	A7PS-255-1	---	---

Note: 1. The classification diagrams show 4 Switch Units combined with End Caps to create 4-digit displays.

2. The model numbers given above are for 1 Switch Unit.

3. Models with stoppers are also available. Add "-S□□" after the "203," "206," "207," "219," "254," or "255" in the model number and specify the display range in the □□. For example, to specify the range 0 to 6, add "-S06" to the model number (e.g., A7PS-206-S06-1).

4. Models with +, - displays can also be produced. Add "-PM" after the "206" in the model number (e.g., A7PS-206-PM or A7PS-206-PM-1)

*1. Models with PCB terminals are available.

*2. Models with diodes are available. Add "-D" to the model number (e.g., A7PS-207-D or A7PS-207-D-1).

Accessories (Order Separately)

Use accessories, such as End Caps and Spacers, with the Switch Units.

Accessory	Color	Light gray	Black
End Caps		A7P-M *	A7P-M-1 *
Spacer		A7P-P□ (See note.)	A7P-P□-1 (See note.)
Connectors	Solder terminals	NRT-C	
		NRT-CN	
		NRT-CP	
	PCB terminals		

Note: The □ in the Spacer model number stands for a letter in the range A to U. (Refer to the table in the following explanation about Spacers.)

* The minimum order is for 10 End Caps.

End Caps

End Caps are used on the Switch Units at each end and allow all the Switch Units to be securely mounted to a panel. They come in pairs, one for the left and one for the right.

Spacers

- Spacers are used for creating extra space or gaps between the Switch Units and have the same dimensions as the Switch Units themselves.
- There are also Spacers with engraved characters or symbols that can be used for indicating units, such as time and length. (Refer to the following table.) Consult your OMRON representative for details.

Symbol	A	B	C	D	E	F	G
Stamp	No designation	SEC	MIN	H	g	kg	mm
Symbol	H	J	K	L	Q	T	U
Stamp	cm	m	°C	PCS	x 10 SEC	0	•

Specifications

Item	Model	A7PS	A7PH
Switching capacity (resistive load)		50 VAC or 5 to 28 VDC 1 mA to 0.1 A	125 VAC or 5 to 28 VDC 10 μA to 0.15 A
Continuous carry current		1 A max.	3 A max.
Contact resistance		300 mΩ max.	
Insulation resistance	Between non-connected terminals	10 MΩ min. (at 500 VDC)	
	Between terminal and non-current carrying part	1,000 MΩ min. (at 500 VDC)	
Dielectric strength	Between non-connected terminals	600 VAC, 50/60 Hz for 1 min	
	Between terminal and non-current carrying part	1,000 VAC, 50/60 Hz for 1 min	
Vibration resistance		10 to 55 Hz, 1.5-mm double amplitude for 2 hours min.	
Shock resistance		490 m/s ² min.	
Durability	Mechanical	100,000 operations min.	2,000,000 operations min.
	Electrical	50,000 operations min.	1,000,000 operations min.
Ambient temperature		Operating: -10°C to 65°C	
Ambient humidity		Operating: 45% to 85%	
Max. operating force		6.37 N max.	

Dimensions

(Unit: mm)

Switches

A7PS-2□□(-1)
A7PH-2□□(-1)
Solder Terminal

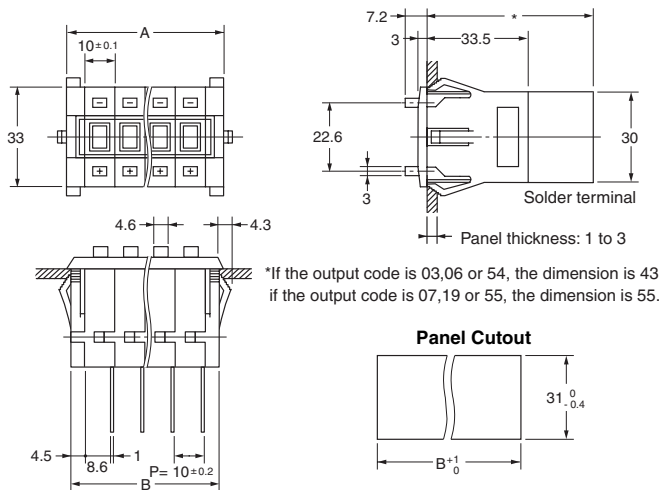
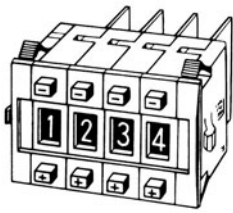

Number of Switches (n)	Size A (n x 10 + 12)	Size B (n x 10 + 9)
1	22	19
2	32	29
3	42	39
4	52	49
5	62	59
6	72	69
7	82	79
8	92	89
9	102	99
10	112	109

Note: 1. The dimensions above include both End Caps, and will increase 10 mm for each Spacer inserted.
2. Unless otherwise specified, a tolerance of ±0.4 mm applies to all dimensions. The tolerance for multiple connection is ±(number of units x 0.4) mm.

Accessories (Order Separately)

End Caps for Push-operated Switches

A7P-M(-1) Snap-in Panel Mounting

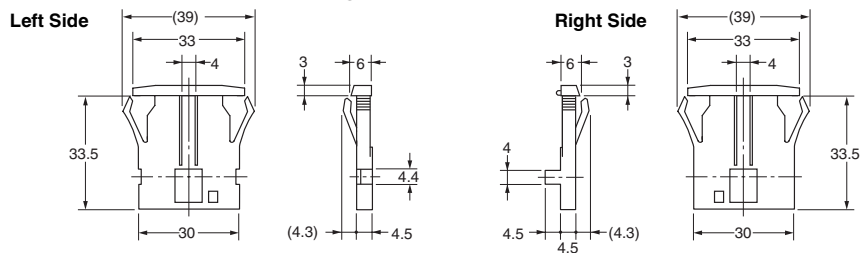

Spacers for Push-operated Switches

A7P-P□(-1) Snap-in Panel Mounting

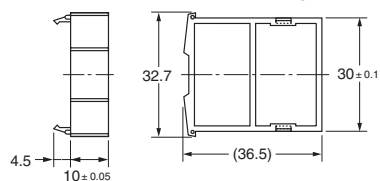

The □ in the Spacer model number stands for a letter in the range A to U. (Refer to the table under the explanation about Spacers on page 1.)

Note: Unless otherwise indicated, dimensional tolerances for dimensions in the models above are ±0.4 mm.

Connectors

(These devices allow Switches to be quickly removed for maintenance and inspection of connectivity, and quickly re-installed.)

NRT-C Solder Terminals

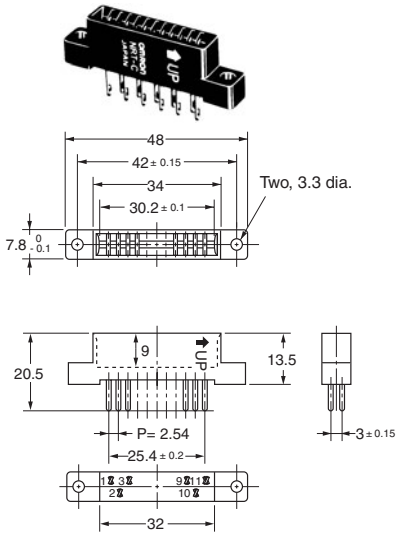

NRT-CN Solder Terminals

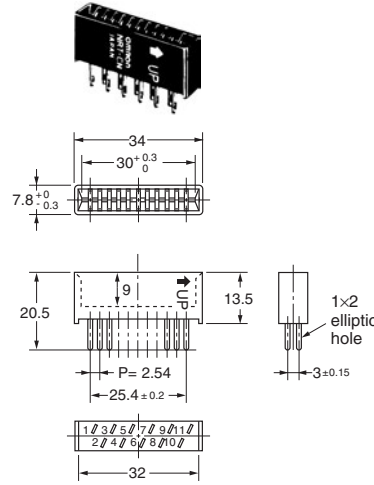

NRT-CP PCB Terminals

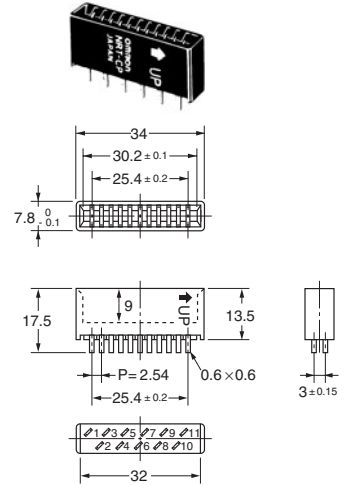

Note: Unless otherwise indicated, dimensional tolerances for dimensions in the models above are ± 0.4 mm.

Inserting Connectors

Insert Connectors with the "UP" arrow pointing up.

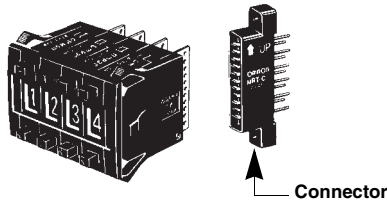

Output Codes/Terminals

- Switches with output codes 06 or 07 both use binary coded decimal but Switches with output code 07 have a component-adding provision. Similarly, Switches with output codes 54 or 55 both use binary coded hexadecimal but Switches with output code 55 have a component-adding provision.
- How to Read Output Codes
For example, when the dial position is "3," the common terminal C on the Switch is connected to terminals 1 and 2. When the Switch is inserted into the Connector, the common terminal C becomes connector terminal 3, and terminals 1 and 2 become connector terminals 5 and 7 respectively.

Output code number	Terminals	Output codes			
		Model	Switch Unit or Connector	Common terminal number	Terminals connected to common
03		03,19	Connector	6	1 2 3 4 5 7 8 9 10 11
		Dial	Switch Unit	C	0 1 2 3 4 5 6 7 8 9
19		03,19	Connector	6	1 2 3 4 5 7 8 9 10 11
		Dial	Switch Unit	C	0 1 2 3 4 5 6 7 8 9
06		06,07	Connector	3	5 7 9 11
		Dial	Switch Unit	C	1 2 4 8
07		06,07	Connector	1	5 7 9 11
		Dial	Switch Unit	C	0 1 2 3 4 5 6 7 8 9

Note: The solid dot ● indicates that the internal switch is ON (i.e., connected to the common terminal).

Note: The solid dot ● indicates that the internal switch is ON (i.e., connected to the common terminal).

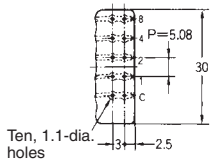
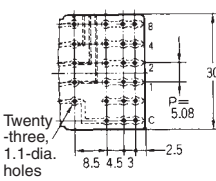
Output code number	Terminals	Output codes																																																																																																																							
54	 <p>Ten, 1.1-dia. holes</p>	<table border="1"> <thead> <tr> <th>Model</th> <th>Switch Unit or Connector</th> <th>Common terminal number</th> <th colspan="4">Terminals connected to common</th> </tr> </thead> <tbody> <tr> <td></td> <td>Switch Unit</td> <td>C</td> <td>1</td> <td>2</td> <td>4</td> <td>8</td> </tr> <tr> <td>54</td> <td>Connector</td> <td>3</td> <td></td> <td></td> <td></td> <td></td> </tr> <tr> <td>55</td> <td>Connector</td> <td>1</td> <td>5</td> <td>7</td> <td>9</td> <td>11</td> </tr> </tbody> </table>	Model	Switch Unit or Connector	Common terminal number	Terminals connected to common					Switch Unit	C	1	2	4	8	54	Connector	3					55	Connector	1	5	7	9	11																																																																																											
		Model	Switch Unit or Connector	Common terminal number	Terminals connected to common																																																																																																																				
	Switch Unit	C	1	2	4	8																																																																																																																			
54	Connector	3																																																																																																																							
55	Connector	1	5	7	9	11																																																																																																																			
55	 <p>Twenty-three, 1.1-dia. holes</p> <p>Component-adding provision</p>	<table border="1"> <thead> <tr> <th>Model</th> <th>Switch Unit or Connector</th> <th>Common terminal number</th> <th colspan="4">Terminals connected to common</th> </tr> </thead> <tbody> <tr> <td></td> <td></td> <td>0</td> <td></td> <td></td> <td></td> <td></td> </tr> <tr> <td></td> <td></td> <td>1</td> <td>●</td> <td></td> <td></td> <td></td> </tr> <tr> <td></td> <td></td> <td>2</td> <td></td> <td>●</td> <td></td> <td></td> </tr> <tr> <td></td> <td></td> <td>3</td> <td>●</td> <td>●</td> <td></td> <td></td> </tr> <tr> <td></td> <td></td> <td>4</td> <td></td> <td></td> <td>●</td> <td></td> </tr> <tr> <td></td> <td></td> <td>5</td> <td>●</td> <td></td> <td>●</td> <td></td> </tr> <tr> <td></td> <td></td> <td>6</td> <td></td> <td>●</td> <td>●</td> <td></td> </tr> <tr> <td></td> <td></td> <td>7</td> <td>●</td> <td>●</td> <td>●</td> <td></td> </tr> <tr> <td></td> <td></td> <td>8</td> <td></td> <td></td> <td></td> <td>●</td> </tr> <tr> <td></td> <td></td> <td>9</td> <td>●</td> <td></td> <td></td> <td>●</td> </tr> <tr> <td></td> <td></td> <td>A</td> <td></td> <td>●</td> <td></td> <td>●</td> </tr> <tr> <td></td> <td></td> <td>B</td> <td>●</td> <td>●</td> <td></td> <td>●</td> </tr> <tr> <td></td> <td></td> <td>C</td> <td></td> <td></td> <td>●</td> <td>●</td> </tr> <tr> <td></td> <td></td> <td>D</td> <td>●</td> <td></td> <td>●</td> <td>●</td> </tr> <tr> <td></td> <td></td> <td>E</td> <td></td> <td>●</td> <td>●</td> <td>●</td> </tr> <tr> <td></td> <td></td> <td>F</td> <td>●</td> <td>●</td> <td>●</td> <td>●</td> </tr> </tbody> </table> <p>Note: 1. The solid dot (●) indicates that the internal switch is ON (i.e., connected to the common terminal).</p>	Model	Switch Unit or Connector	Common terminal number	Terminals connected to common						0							1	●						2		●					3	●	●					4			●				5	●		●				6		●	●				7	●	●	●				8				●			9	●			●			A		●		●			B	●	●		●			C			●	●			D	●		●	●			E		●	●	●			F	●	●	●	●
		Model	Switch Unit or Connector	Common terminal number	Terminals connected to common																																																																																																																				
				0																																																																																																																					
				1	●																																																																																																																				
				2		●																																																																																																																			
				3	●	●																																																																																																																			
				4			●																																																																																																																		
				5	●		●																																																																																																																		
				6		●	●																																																																																																																		
				7	●	●	●																																																																																																																		
				8				●																																																																																																																	
				9	●			●																																																																																																																	
				A		●		●																																																																																																																	
		B	●	●		●																																																																																																																			
		C			●	●																																																																																																																			
		D	●		●	●																																																																																																																			
		E		●	●	●																																																																																																																			
		F	●	●	●	●																																																																																																																			

Ordering Procedure

Place orders as shown in the example below, specifying the model and number.

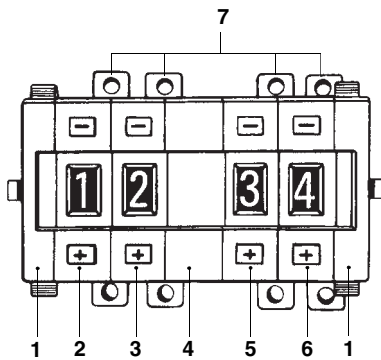

1. A7P-M (End Caps): 1 set
2. A7PS-203 (Switch Unit): 1 piece
3. A7PS-206 (Switch Unit): 1 piece
4. A7P-PA (Spacer): 1 piece
5. A7PS-207 (Switch Unit): 1 piece
6. A7PS-219 (Switch Unit): 1 piece

Note: Standard products are not factory-assembled for shipment. Contact your OMRON representative for details on ordering factory-assembled sets.

7. NRT-C (Connector): 4 pieces

Safety Precautions

Refer to *Precautions for Correct Use* on in the *Technical Guide for Thumbwheel Switches*.

Precautions for Correct Use

Handling

- The molded components of the Switch use polyacetal resin and ABS resin. It is recommended that alcohol is used to wipe off dirt and smudges from the molded components. Take care to prevent the alcohol from getting inside.
- A7P Thumbwheel Switches are dust-proof, but they are not drip-proof. Do not use them in areas subject to water or oil exposure.
- Do not allow solder flux or alcohol to enter the Switch.
- Do not push the (+) and (-) operating push-buttons at the same time.

Read and Understand This Catalog

Please read and understand this catalog before purchasing the products. Please consult your OMRON representative if you have any questions or comments.

Warranty and Limitations of Liability

WARRANTY

OMRON's exclusive warranty is that the products are free from defects in materials and workmanship for a period of one year (or other period if specified) from date of sale by OMRON.

OMRON MAKES NO WARRANTY OR REPRESENTATION, EXPRESS OR IMPLIED, REGARDING NON-INFRINGEMENT, MERCHANTABILITY, OR FITNESS FOR PARTICULAR PURPOSE OF THE PRODUCTS. ANY BUYER OR USER ACKNOWLEDGES THAT THE BUYER OR USER ALONE HAS DETERMINED THAT THE PRODUCTS WILL SUITABLY MEET THE REQUIREMENTS OF THEIR INTENDED USE. OMRON DISCLAIMS ALL OTHER WARRANTIES, EXPRESS OR IMPLIED.

LIMITATIONS OF LIABILITY

OMRON SHALL NOT BE RESPONSIBLE FOR SPECIAL, INDIRECT, OR CONSEQUENTIAL DAMAGES, LOSS OF PROFITS OR COMMERCIAL LOSS IN ANY WAY CONNECTED WITH THE PRODUCTS, WHETHER SUCH CLAIM IS BASED ON CONTRACT, WARRANTY, NEGLIGENCE, OR STRICT LIABILITY.

In no event shall the responsibility of OMRON for any act exceed the individual price of the product on which liability is asserted.

IN NO EVENT SHALL OMRON BE RESPONSIBLE FOR WARRANTY, REPAIR, OR OTHER CLAIMS REGARDING THE PRODUCTS UNLESS OMRON'S ANALYSIS CONFIRMS THAT THE PRODUCTS WERE PROPERLY HANDLED, STORED, INSTALLED, AND MAINTAINED AND NOT SUBJECT TO CONTAMINATION, ABUSE, MISUSE, OR INAPPROPRIATE MODIFICATION OR REPAIR.

Application Considerations

SUITABILITY FOR USE

OMRON shall not be responsible for conformity with any standards, codes, or regulations that apply to the combination of products in the customer's application or use of the products.

At the customer's request, OMRON will provide applicable third party certification documents identifying ratings and limitations of use that apply to the products. This information by itself is not sufficient for a complete determination of the suitability of the products in combination with the end product, machine, system, or other application or use.

The following are some examples of applications for which particular attention must be given. This is not intended to be an exhaustive list of all possible uses of the products, nor is it intended to imply that the uses listed may be suitable for the products:

- Outdoor use, uses involving potential chemical contamination or electrical interference, or conditions or uses not described in this catalog.
- Nuclear energy control systems, combustion systems, railroad systems, aviation systems, medical equipment, amusement machines, vehicles, safety equipment, and installations subject to separate industry or government regulations.
- Systems, machines, and equipment that could present a risk to life or property.

Please know and observe all prohibitions of use applicable to the products.

NEVER USE THE PRODUCTS FOR AN APPLICATION INVOLVING SERIOUS RISK TO LIFE OR PROPERTY WITHOUT ENSURING THAT THE SYSTEM AS A WHOLE HAS BEEN DESIGNED TO ADDRESS THE RISKS, AND THAT THE OMRON PRODUCTS ARE PROPERLY RATED AND INSTALLED FOR THE INTENDED USE WITHIN THE OVERALL EQUIPMENT OR SYSTEM.

PROGRAMMABLE PRODUCTS

OMRON shall not be responsible for the user's programming of a programmable product, or any consequence thereof.

Disclaimers

CHANGE IN SPECIFICATIONS

Product specifications and accessories may be changed at any time based on improvements and other reasons.

It is our practice to change model numbers when published ratings or features are changed, or when significant construction changes are made. However, some specifications of the products may be changed without any notice. When in doubt, special model numbers may be assigned to fix or establish key specifications for your application on your request. Please consult with your OMRON representative at any time to confirm actual specifications of purchased products.

DIMENSIONS AND WEIGHTS

Dimensions and weights are nominal and are not to be used for manufacturing purposes, even when tolerances are shown.

PERFORMANCE DATA

Performance data given in this catalog is provided as a guide for the user in determining suitability and does not constitute a warranty. It may represent the result of OMRON's test conditions, and the users must correlate it to actual application requirements. Actual performance is subject to the OMRON Warranty and Limitations of Liability.

ERRORS AND OMISSIONS

The information in this document has been carefully checked and is believed to be accurate; however, no responsibility is assumed for clerical, typographical, or proofreading errors, or omissions.

2011.2

In the interest of product improvement, specifications are subject to change without notice.

OMRON Corporation
Industrial Automation Company

<http://www.ia.omron.com/>

(c)Copyright OMRON Corporation 2011 All Right Reserved.

Компания «Life Electronics» занимается поставками электронных компонентов импортного и отечественного производства от производителей и со складов крупных дистрибьюторов Европы, Америки и Азии.

С конца 2013 года компания активно расширяет линейку поставок компонентов по направлению коаксиальный кабель, кварцевые генераторы и конденсаторы (керамические, пленочные, электролитические), за счёт заключения дистрибьюторских договоров

Мы предлагаем:

- Конкурентоспособные цены и скидки постоянным клиентам.
- Специальные условия для постоянных клиентов.
- Подбор аналогов.
- Поставку компонентов в любых объемах, удовлетворяющих вашим потребностям.
- Приемлемые сроки поставки, возможна ускоренная поставка.
- Доставку товара в любую точку России и стран СНГ.
- Комплексную поставку.
- Работу по проектам и поставку образцов.
- Формирование склада под заказчика.
- Сертификаты соответствия на поставляемую продукцию (по желанию клиента).
- Тестирование поставляемой продукции.
- Поставку компонентов, требующих военную и космическую приемку.
- Входной контроль качества.
- Наличие сертификата ISO.

В составе нашей компании организован Конструкторский отдел, призванный помогать разработчикам, и инженерам.

Конструкторский отдел помогает осуществить:

- Регистрацию проекта у производителя компонентов.
- Техническую поддержку проекта.
- Защиту от снятия компонента с производства.
- Оценку стоимости проекта по компонентам.
- Изготовление тестовой платы монтаж и пусконаладочные работы.



Тел: +7 (812) 336 43 04 (многоканальный)

Email: org@lifeelectronics.ru