

Part Number: WP115WEGW

High Efficiency Red
Green

Features

- Uniform light output.
- Low power consumption.
- 3 leads with one common lead.
- Long life - solid state reliability.
- RoHS compliant.

Description

The High Efficiency Red source color devices are made with Gallium Arsenide Phosphide on Gallium Phosphide Orange Light Emitting Diode.

The Green source color devices are made with Gallium Phosphide Green Light Emitting Diode.

Package Dimensions

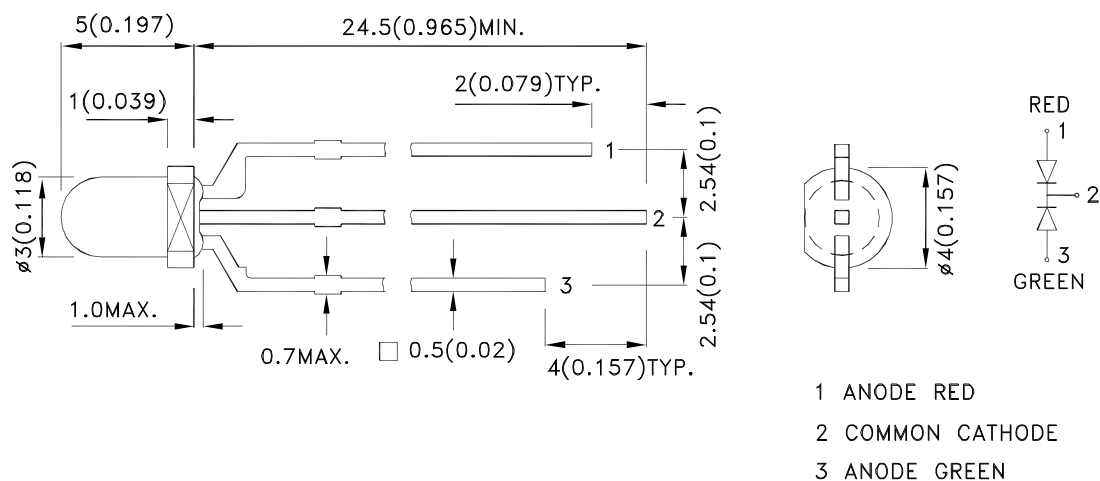

Notes:

1. All dimensions are in millimeters (inches).
2. Tolerance is $\pm 0.25(0.01)$ " unless otherwise noted.
3. Lead spacing is measured where the leads emerge from the package.
4. The specifications, characteristics and technical data described in the datasheet are subject to change without prior notice.



Selection Guide

Part No.	Dice	Lens Type	Iv (mcd) [2] @ 20mA		Viewing Angle [1]
			Min.	Typ.	2θ1/2
WP115WEGW	High Efficiency Red (GaAsP/GaP)	White Diffused	20	40	60°
	Green (GaP)		20	40	

Notes:

1. θ1/2 is the angle from optical centerline where the luminous intensity is 1/2 of the optical peak value.
2. Luminous intensity/ luminous Flux: +/-15%.

Electrical / Optical Characteristics at TA=25°C

Symbol	Parameter	Device	Typ.	Max.	Units	Test Conditions
λ_{peak}	Peak Wavelength	High Efficiency Red Green	627 565		nm	I _F =20mA
λ_D [1]	Dominant Wavelength	High Efficiency Red Green	625 568		nm	I _F =20mA
$\Delta\lambda_{1/2}$	Spectral Line Half-width	High Efficiency Red Green	45 30		nm	I _F =20mA
C	Capacitance	High Efficiency Red Green	15 15		pF	V _F =0V;f=1MHz
V _F [2]	Forward Voltage	High Efficiency Red Green	2 2.2	2.5 2.5	V	I _F =20mA
I _R	Reverse Current	High Efficiency Red Green		10 10	uA	V _R = 5V

Notes:

1. Wavelength: +/-1nm.
2. Forward Voltage: +/-0.1V.

Absolute Maximum Ratings at TA=25°C

Parameter	High Efficiency Red	Green	Units
Power dissipation	75	62.5	mW
DC Forward Current	30	25	mA
Peak Forward Current [1]	160	140	mA
Reverse Voltage	5		V
Operating / Storage Temperature	-40°C To +85°C		
Lead Solder Temperature [2]	260°C For 3 Seconds		
Lead Solder Temperature [3]	260°C For 5 Seconds		

Notes:

1. 1/10 Duty Cycle, 0.1ms Pulse Width.
2. 2mm below package base.
3. 5mm below package base.

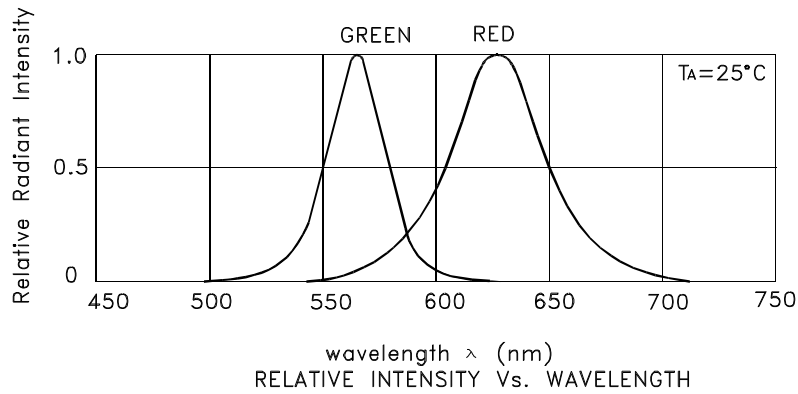

WP115WEGW High Efficiency Red

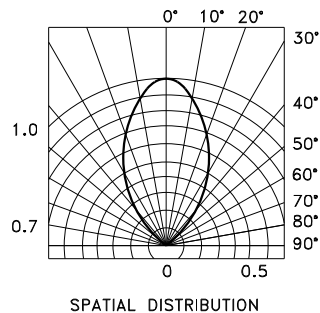
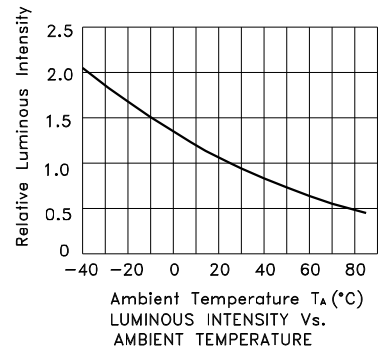
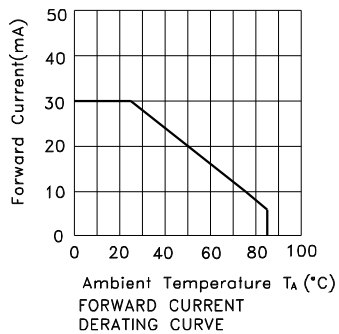
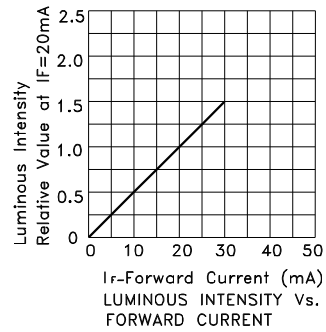
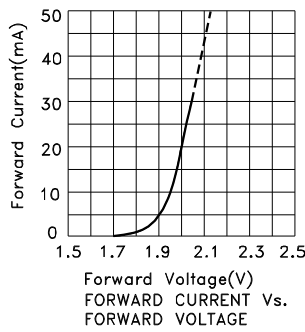

Green

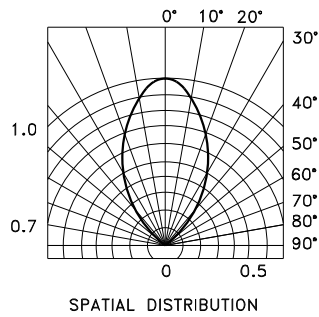
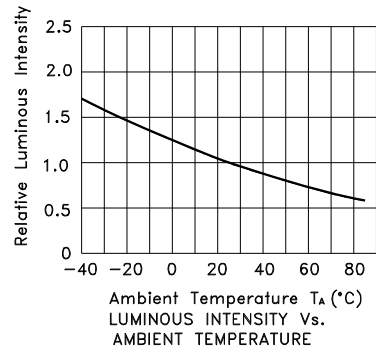
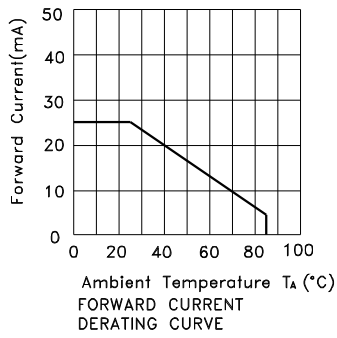
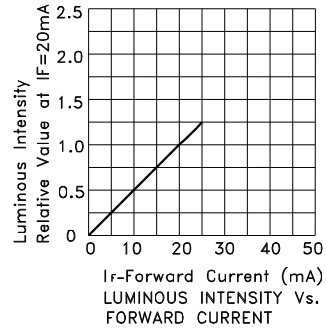
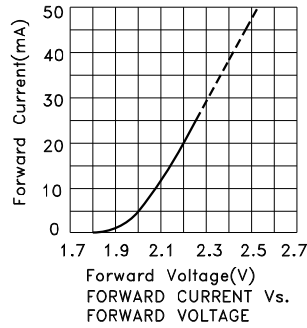

Kingbright

PACKING & LABEL SPECIFICATIONS

WP115WEGW

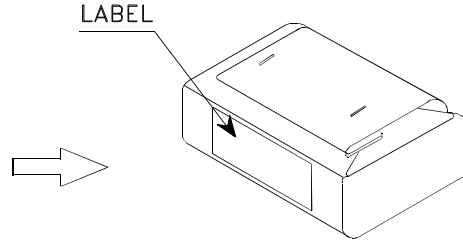
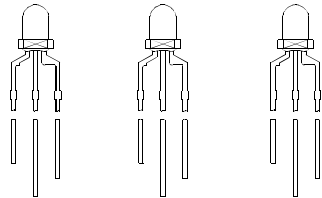

500PCS / BAG



32K / 9# BOX

OUTSIDE LABEL

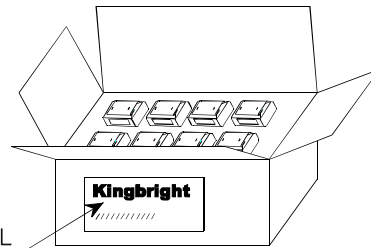
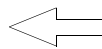

OUTSIDE LABEL

16K / 5# BOX

Kingbright	
P/NO: WP115WXXX	
QTY: 500 pcs	Q.C. Q C xx xx xxxx PASSED
S/N: XXXX	
CODE: XXX	
LOT NO:	
 xxxxxxxxxxxxxxxxxxxxxxxx	
RoHS Compliant	

PRECAUTIONS

1. The lead pitch of the LED must match the pitch of the mounting holes on the PCB during component placement. Lead-forming may be required to insure the lead pitch matches the hole pitch. Refer to the figure below for proper lead forming procedures. (Fig. 1)

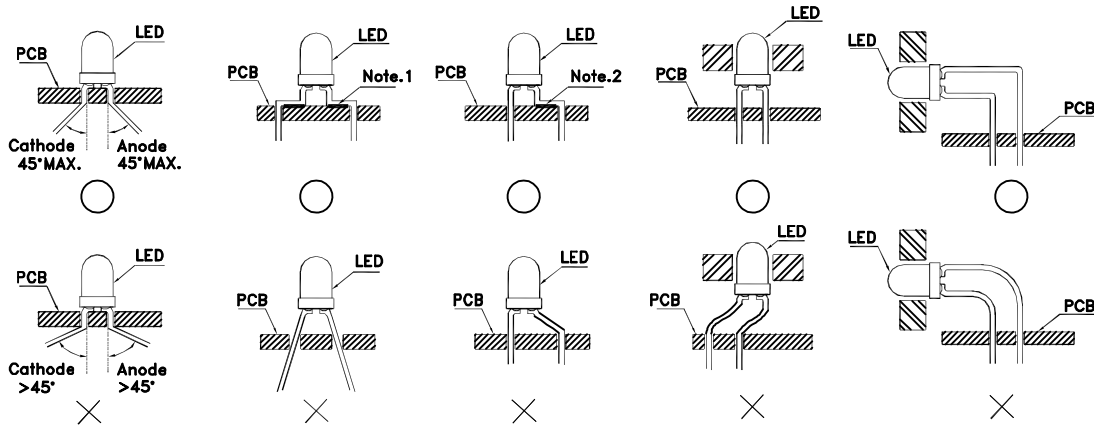

Fig.1

”○” Correct mounting method ”×” Incorrect mounting method

2. When soldering wire to the LED, use individual heat-shrink tubing to insulate the exposed leads to prevent accidental contact short-circuit. (Fig.2)

3. Use stand-offs (Fig.3) or spacers (Fig.4) to securely position the LED above the PCB.

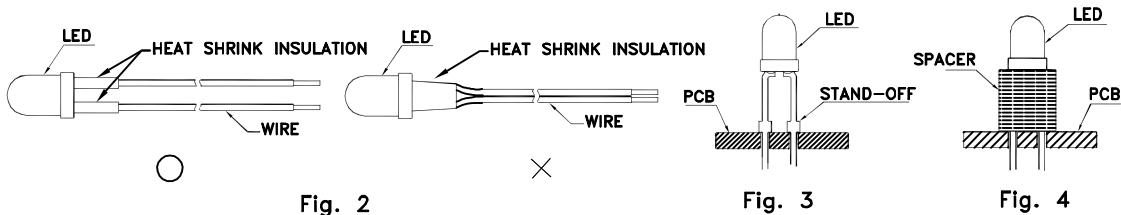

Fig. 2

Fig. 3

Fig. 4

4. Maintain a minimum of 2mm clearance between the base of the LED lens and the first lead bend. (Fig. 5 and 6)
5. During lead forming, use tools or jigs to hold the leads securely so that the bending force will not be transmitted to the LED lens and its internal structures. Do not perform lead forming once the component has been mounted onto the PCB. (Fig. 7)

6. Do not bend the leads more than twice. (Fig. 8)

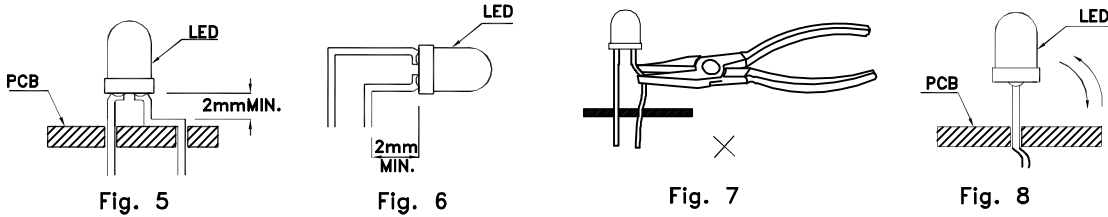

7. During soldering, component covers and holders should leave clearance to avoid placing damaging stress on the LED during soldering.

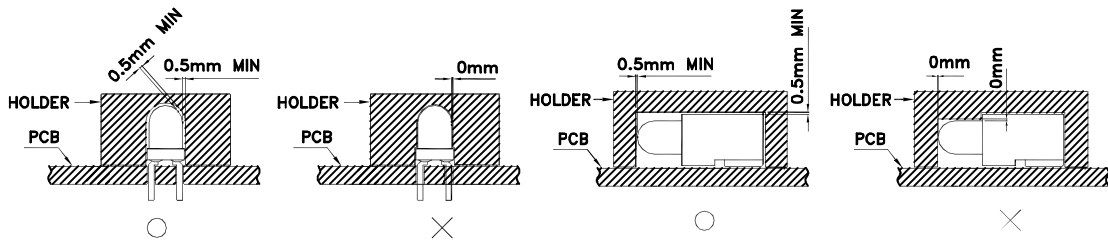

8. The tip of the soldering iron should never touch the lens epoxy.

9. Through-hole LEDs are incompatible with reflow soldering.

10. If the LED will undergo multiple soldering passes or face other processes where the part may be subjected to intense heat, please check with Kingbright for compatibility.

11. Recommended Wave Soldering Profile for Kingbright Thru-Hole Products

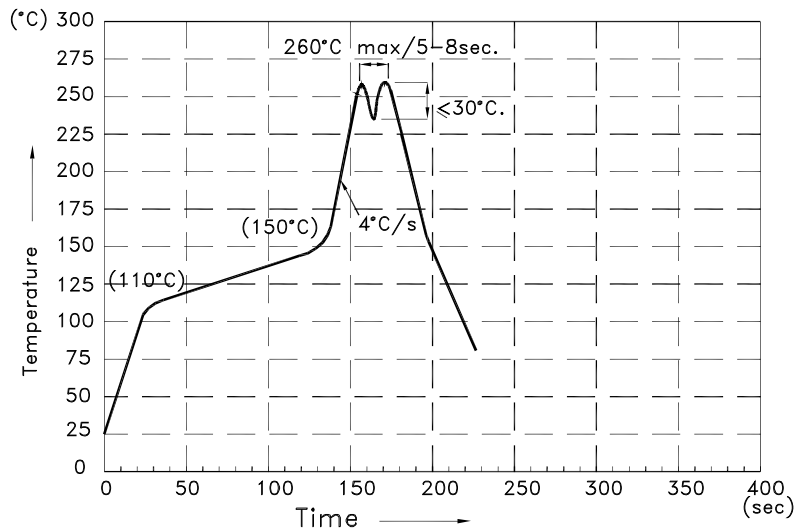

NOTES:

1. Recommend the wave temperature 245°C~260°C. The maximum soldering temperature should be less than 260°C.
2. Do not apply stress on epoxy resins when temperature is over 85°C.
3. The soldering profile apply to the lead free soldering (Sn/Cu/Ag alloy).
4. During wave soldering, the PCB top-surface temperature should be kept below 105°C.
5. No more than once.

Компания «Life Electronics» занимается поставками электронных компонентов импортного и отечественного производства от производителей и со складов крупных дистрибьюторов Европы, Америки и Азии.

С конца 2013 года компания активно расширяет линейку поставок компонентов по направлению коаксиальный кабель, кварцевые генераторы и конденсаторы (керамические, пленочные, электролитические), за счёт заключения дистрибьюторских договоров

Мы предлагаем:

- Конкурентоспособные цены и скидки постоянным клиентам.
- Специальные условия для постоянных клиентов.
- Подбор аналогов.
- Поставку компонентов в любых объемах, удовлетворяющих вашим потребностям.
- Приемлемые сроки поставки, возможна ускоренная поставка.
- Доставку товара в любую точку России и стран СНГ.
- Комплексную поставку.
- Работу по проектам и поставку образцов.
- Формирование склада под заказчика.
- Сертификаты соответствия на поставляемую продукцию (по желанию клиента).
- Тестирование поставляемой продукции.
- Поставку компонентов, требующих военную и космическую приемку.
- Входной контроль качества.
- Наличие сертификата ISO.

В составе нашей компании организован Конструкторский отдел, призванный помогать разработчикам, и инженерам.

Конструкторский отдел помогает осуществить:

- Регистрацию проекта у производителя компонентов.
- Техническую поддержку проекта.
- Защиту от снятия компонента с производства.
- Оценку стоимости проекта по компонентам.
- Изготовление тестовой платы монтаж и пусконаладочные работы.



Тел: +7 (812) 336 43 04 (многоканальный)

Email: org@lifeelectronics.ru