



### Typical Applications

The HMC662LP3E is ideal for:

- Point-to-Point Microwave Radio
- VSAT
- Wideband Power Monitoring
- Receiver Signal Strength Indication (RSSI)
- Test & Measurement

### Features

- Wide Input Bandwidth: 8 to 30 GHz
- Wide Dynamic Range: >54 dB up to 28 GHz
- Single Positive Supply: +3.3V
- Excellent Stability Over Temperature
- Fast Rise/Fall Time: 5ns / 10ns
- 16 Lead 3x3mm SMT Package: 9mm<sup>2</sup>

### Functional Diagram

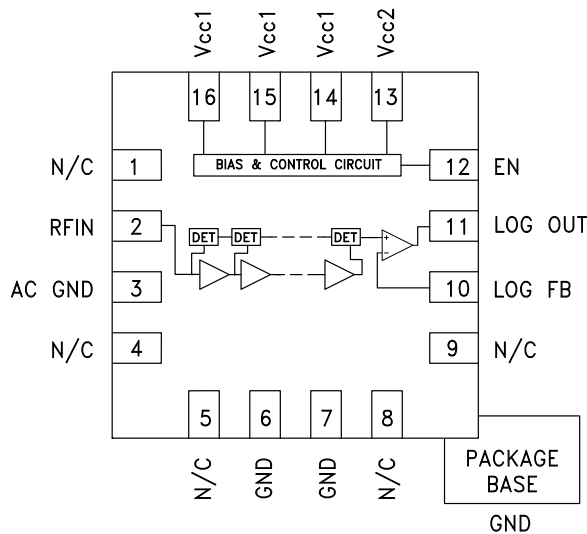

### General Description

The HMC662LP3E Logarithmic Detector converts RF signals at its input, to a proportional DC voltage at its output. The HMC662LP3E employs successive compression topology which delivers high dynamic range over a wide input frequency range. As the input power is increased, successive amplifiers move into saturation one by one creating an approximation of the logarithm function. The output of a series of detectors is summed, converted into the voltage domain and buffered to drive the LOG OUT output. The HMC662LP3E provides a nominal logarithmic slope of +13 mV/dB and an intercept of -127 dBm at 18 GHz. Ideal as a log detector for high volume microwave radio and VSAT applications, the HMC662LP3E is housed in a compact 3x3 mm RoHS compliant SMT plastic package.

### Electrical Specifications, $T_A = +25\text{ C}$ $V_{cc1} = V_{cc2} = +3.3\text{V}$

| Parameter                               | Typ. | Typ. | Typ. | Typ. | Typ. | Units |
|-----------------------------------------|------|------|------|------|------|-------|
| Input Frequency <sup>[1]</sup>          | 10   | 14   | 18   | 22   | 28   | GHz   |
| ±3 dB Dynamic Range                     | 59   | 60   | 63   | 64   | 54   | dB    |
| ±3 dB Dynamic Range Center              | -23  | -24  | -24  | -25  | -17  | dBm   |
| Log Error Over Temperature (-40 to +85) | ±1   | ±1   | ±1   | ±2   | ±3   | dB    |
| Output Intercept                        | -120 | -125 | -127 | -130 | -113 | dBm   |
| Output Slope                            | 14.6 | 13.7 | 13.3 | 13.2 | 14   | mV/dB |

[1] Video output load should be 1K Ohm or higher.



**54 dB, LOGARITHMIC DETECTOR, 8 - 30 GHz**

**Electrical Specifications, (continued)**

| Parameter                                                  | Conditions | Min.      | Typ.   | Max.      | Units |
|------------------------------------------------------------|------------|-----------|--------|-----------|-------|
| <b>LOGOUT Interface</b>                                    |            |           |        |           |       |
| Output Voltage Range                                       |            | 0.9       |        | 1.8       | V     |
| Output Rise Time <sup>[1]</sup> / Fall Time <sup>[2]</sup> | f = 10 GHz |           | 5 / 10 |           | ns    |
| <b>Power Down (EN) Interface</b>                           |            |           |        |           |       |
| Voltage Range for Normal Mode                              |            | 0.8 x Vcc |        | Vcc       | V     |
| Voltage Range for Powerdown Mode                           |            | 0         |        | 0.1 x Vcc | V     |
| <b>Power Supply (Vcc1, Vcc2)</b>                           |            |           |        |           |       |
| Operating Voltage Range                                    |            | 3.15      | 3.3    | 3.45      | V     |
| Supply Current in Normal Mode                              |            |           | 88     |           | mA    |
| Supply Current in Power Down Mode                          |            |           | 3      |           | mA    |

[1] 0 dBm Input Pulsed; measured from 10% to 90%  
 [2] 0 dBm Input Pulsed; measured from 90% to 10%

**LOG OUT & Error vs. Input Power, Fin = 8 GHz**

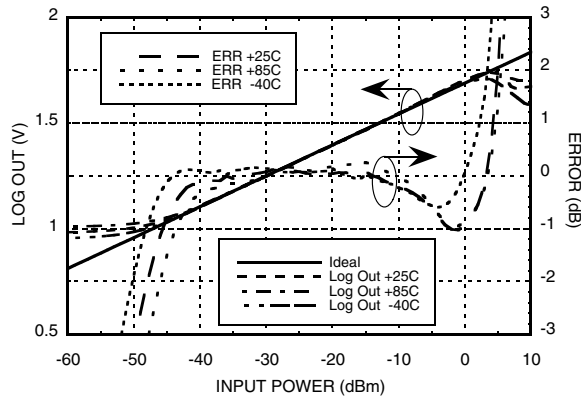

**LOG OUT & Error vs. Input Power, Fin = 10 GHz**

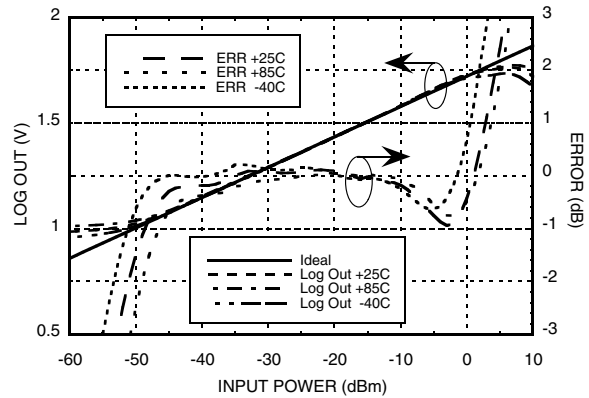

**LOG OUT & Error vs. Input Power, Fin = 14 GHz**

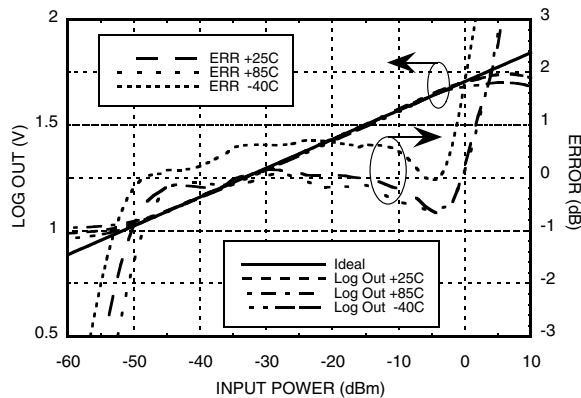

**LOG OUT & Error vs. Input Power, Fin = 18 GHz**

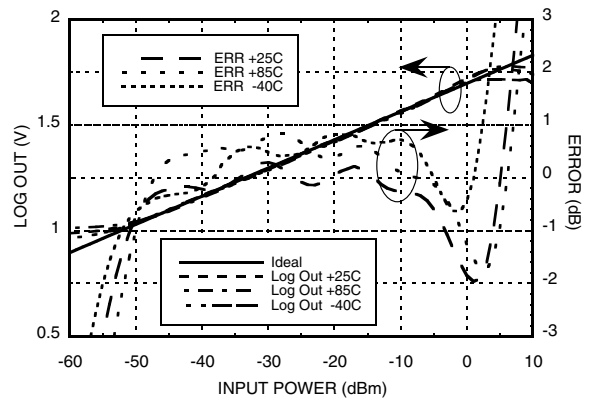

Unless otherwise noted: Vcc1, Vcc2 = +3.3V, TA = +25 °C

Information furnished by Analog Devices is believed to be accurate and reliable. However, no responsibility is assumed by Analog Devices for its use, nor for any infringements of patents or other rights of third parties that may result from its use. Specifications subject to change without notice. No license is granted by implication or otherwise under any patent or patent rights of Analog Devices. Trademarks and registered trademarks are the property of their respective owners.

For price, delivery, and to place orders: Analog Devices, Inc., One Technology Way, P.O. Box 9106, Norwood, MA 02062-9106 Phone: 781-329-4700 • Order online at [www.analog.com](http://www.analog.com) Application Support: Phone: 1-800-ANALOG-D



**54 dB, LOGARITHMIC DETECTOR, 8 - 30 GHz**

**LOG OUT & Error vs. Input Power, Fin = 20 GHz**

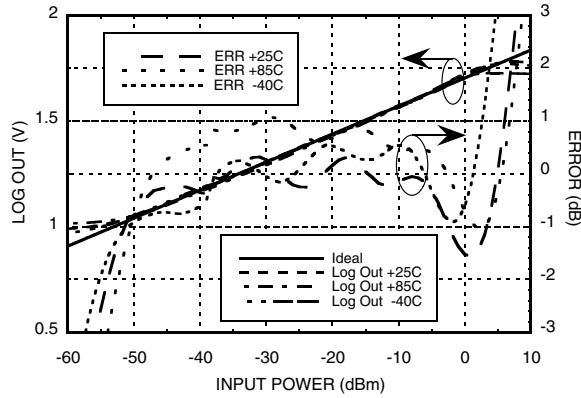

**LOG OUT & Error vs. Input Power, Fin = 22 GHz**

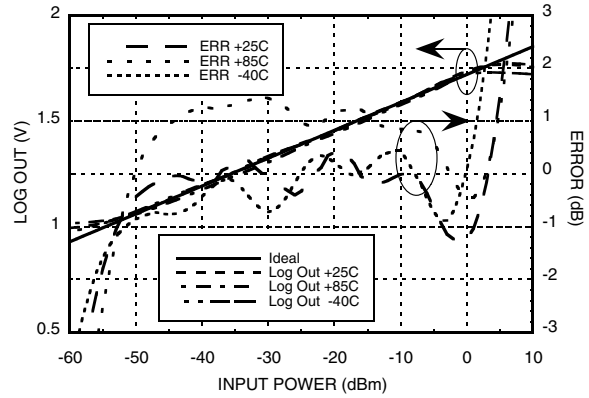

**LOG OUT & Error vs. Input Power, Fin = 24 GHz**

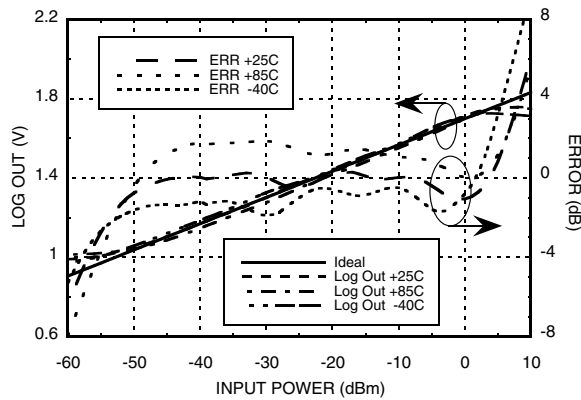

**LOG OUT & Error vs. Input Power, Fin = 28 GHz**

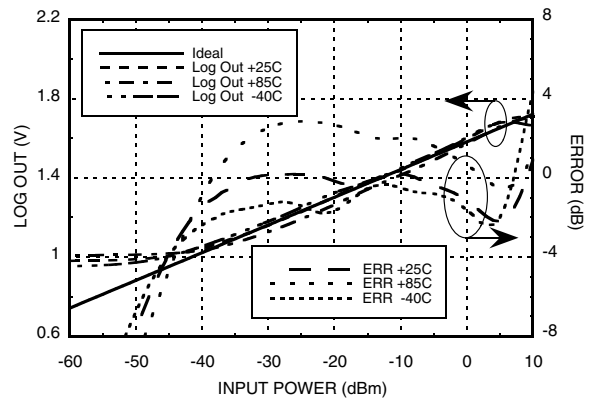

**LOG OUT & Error vs. Input Power, Fin = 30 GHz**

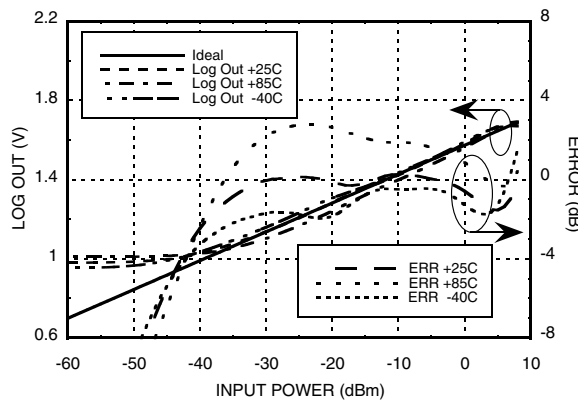

Unless otherwise noted:  $V_{cc1}, V_{cc2} = +3.3V, T_A = +25^\circ C$

Information furnished by Analog Devices is believed to be accurate and reliable. However, no responsibility is assumed by Analog Devices for its use, nor for any infringements of patents or other rights of third parties that may result from its use. Specifications subject to change without notice. No license is granted by implication or otherwise under any patent or patent rights of Analog Devices. Trademarks and registered trademarks are the property of their respective owners.

For price, delivery, and to place orders: Analog Devices, Inc., One Technology Way, P.O. Box 9106, Norwood, MA 02062-9106 Phone: 781-329-4700 • Order online at [www.analog.com](http://www.analog.com) Application Support: Phone: 1-800-ANALOG-D



**54 dB, LOGARITHMIC DETECTOR, 8 - 30 GHz**

**Fall Time @ 10 GHz @ 0 dBm**

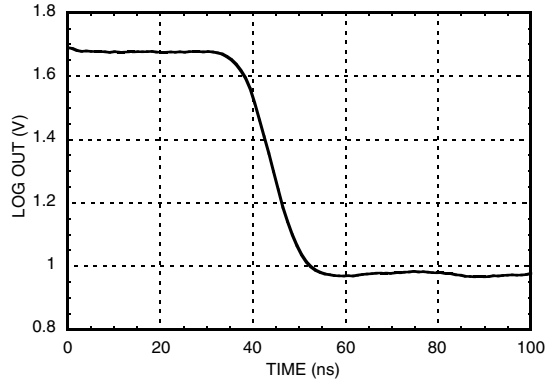

**Rise Time @ 10 GHz @ 0 dBm**

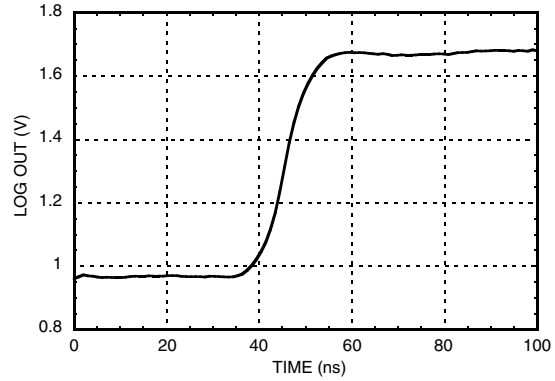

**Input Return Loss**

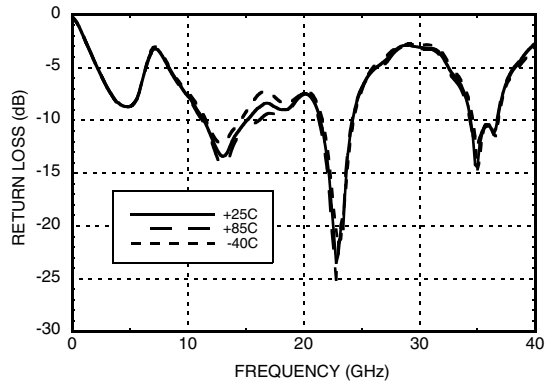

**LOG OUT vs. Frequency**

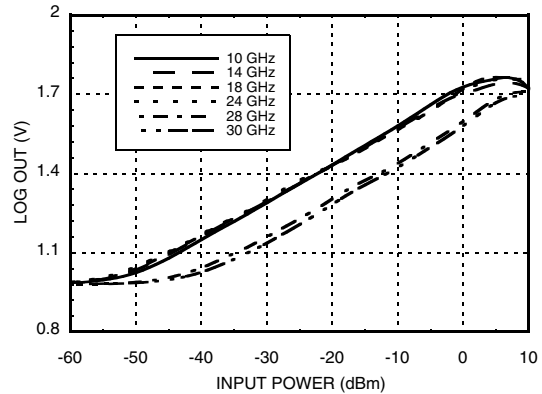

Unless otherwise noted:  $V_{cc1}, V_{cc2} = +3.3V, T_A = +25\text{ }^\circ\text{C}$

Information furnished by Analog Devices is believed to be accurate and reliable. However, no responsibility is assumed by Analog Devices for its use, nor for any infringements of patents or other rights of third parties that may result from its use. Specifications subject to change without notice. No license is granted by implication or otherwise under any patent or patent rights of Analog Devices. Trademarks and registered trademarks are the property of their respective owners.

For price, delivery, and to place orders: Analog Devices, Inc., One Technology Way, P.O. Box 9106, Norwood, MA 02062-9106 Phone: 781-329-4700 • Order online at [www.analog.com](http://www.analog.com) Application Support: Phone: 1-800-ANALOG-D

**54 dB, LOGARITHMIC  
DETECTOR, 8 - 30 GHz**
**Absolute Maximum Ratings**

|                                                                            |                |
|----------------------------------------------------------------------------|----------------|
| EN                                                                         | +3.6V          |
| Vcc1, Vcc2                                                                 | +3.6V          |
| RF Input Power                                                             | +12 dBm        |
| Junction Temperature                                                       | 125 °C         |
| Continuous P <sub>diss</sub> (T = 85°C)<br>(Derate 12.63 mW/°C above 85°C) | 0.51W          |
| Thermal Resistance (R <sub>th</sub> )<br>(junction to ground paddle)       | 15.29 °C/W     |
| Storage Temperature                                                        | -65 to +150 °C |
| Operating Temperature                                                      | -40 to +85 °C  |
| ESD Sensitivity (HBM)                                                      | Class 0        |

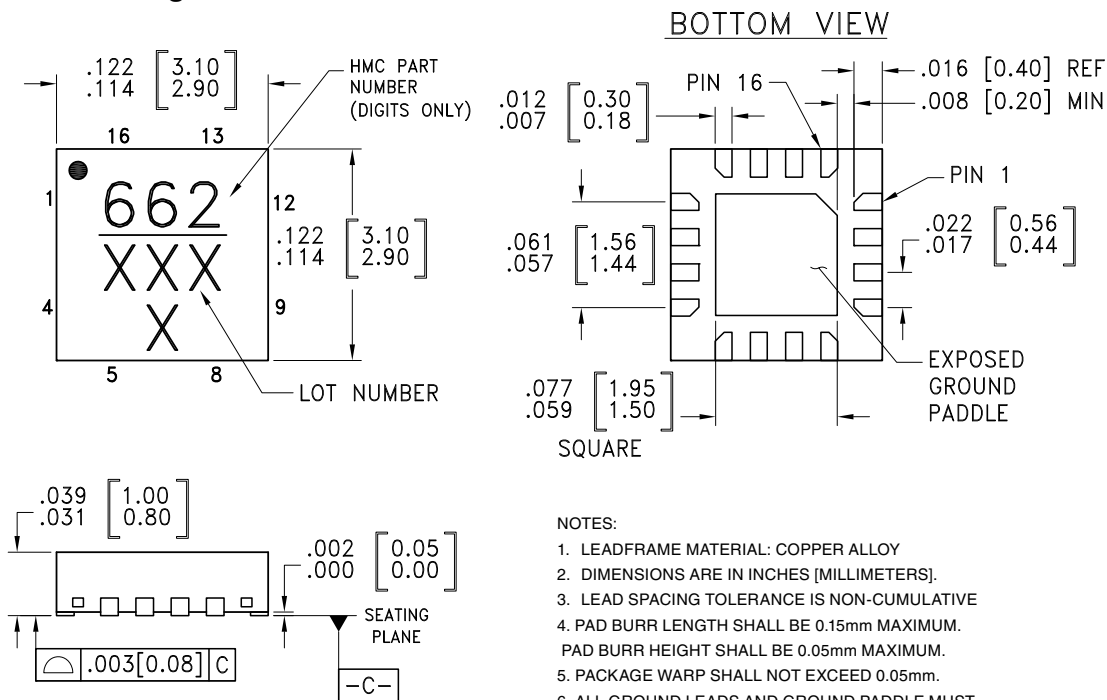
**ELECTROSTATIC SENSITIVE DEVICE  
OBSERVE HANDLING PRECAUTIONS**
**Outline Drawing**

**NOTES:**

- LEADFRAME MATERIAL: COPPER ALLOY
- DIMENSIONS ARE IN INCHES [MILLIMETERS].
- LEAD SPACING TOLERANCE IS NON-CUMULATIVE
- PAD BURR LENGTH SHALL BE 0.15mm MAXIMUM.  
PAD BURR HEIGHT SHALL BE 0.05mm MAXIMUM.
- PACKAGE WARP SHALL NOT EXCEED 0.05mm.
- ALL GROUND LEADS AND GROUND PADDLE MUST BE SOLDERED TO PCB RF GROUND.
- REFER TO HMC APPLICATION NOTE FOR SUGGESTED PCB LAND PATTERN.

**Package Information**

| Part Number | Package Body Material                              | Lead Finish   | MSL Rating          | Package Marking <sup>[1]</sup> |
|-------------|----------------------------------------------------|---------------|---------------------|--------------------------------|
| HMC662LP3E  | RoHS-compliant Low Stress Injection Molded Plastic | 100% matte Sn | MSL1 <sup>[2]</sup> | 662<br>XXX                     |

[1] 4-Digit lot number XXXX

[2] Max peak reflow temperature of 260 °C



### Pin Descriptions

| Pin Number    | Function        | Description                                                                                                                                          | Interface Schematic |
|---------------|-----------------|------------------------------------------------------------------------------------------------------------------------------------------------------|---------------------|
| 1, 4, 5, 8, 9 | N/C             | No connection necessary. These pins may be connected to RF/DC ground without affecting performance.                                                  |                     |
| 2             | RFIN            | RF input pin.                                                                                                                                        |                     |
| 3             | AC GND          | External capacitor to ground is required. See application circuit.                                                                                   |                     |
| 6, 7          | GND             | These pins and the exposed package bottom must be connected to a high quality RF/DC ground.                                                          |                     |
| 10, 11        | LOG FB, LOG OUT | Log out and feedback. These pins should be shorted to each other (see application circuit). Log out load should be at least 1K Ohm or higher.        |                     |
| 12            | EN              | Enable pin connected to Vcc1 or Vcc2 for normal operation. Total supply current reduced to less than 3mA when EN is set to 0V.                       |                     |
| 13            | Vcc2            | Bias Supply. Connect supply voltage to this pin with appropriate filtering. To ensure proper start-up supply rise time should be faster than 100usec |                     |



**54 dB, LOGARITHMIC DETECTOR, 8 - 30 GHz**

**Pin Descriptions (Continued)**

| Pin Number | Function | Description                                                                                                                                            | Interface Schematic |
|------------|----------|--------------------------------------------------------------------------------------------------------------------------------------------------------|---------------------|
| 14 - 16    | Vcc1     | Bias Supply. Connect supply voltage to these pins with appropriate filtering. To ensure proper start-up supply rise time should be faster than 100usec |                     |

**Application & Evaluation PCB Schematic**

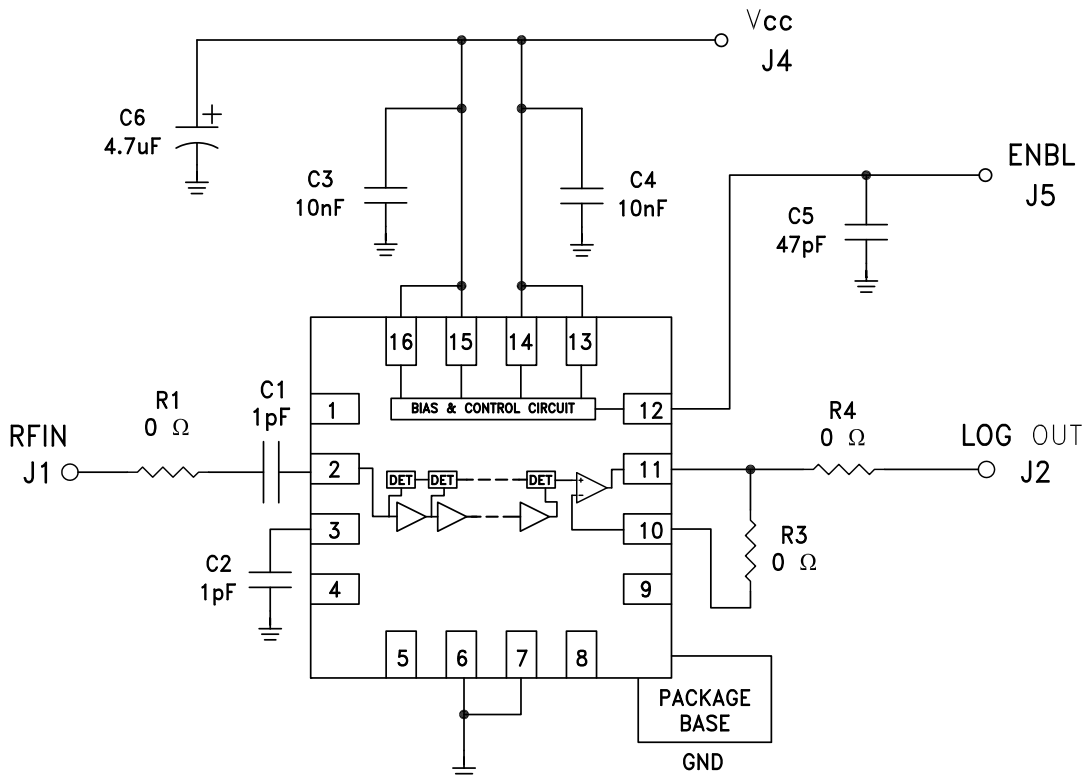

Note1: C1 and C2 should be placed as close to the package as possible.

Note2: Log out load should be 1K Ohm or higher.



### Evaluation PCB

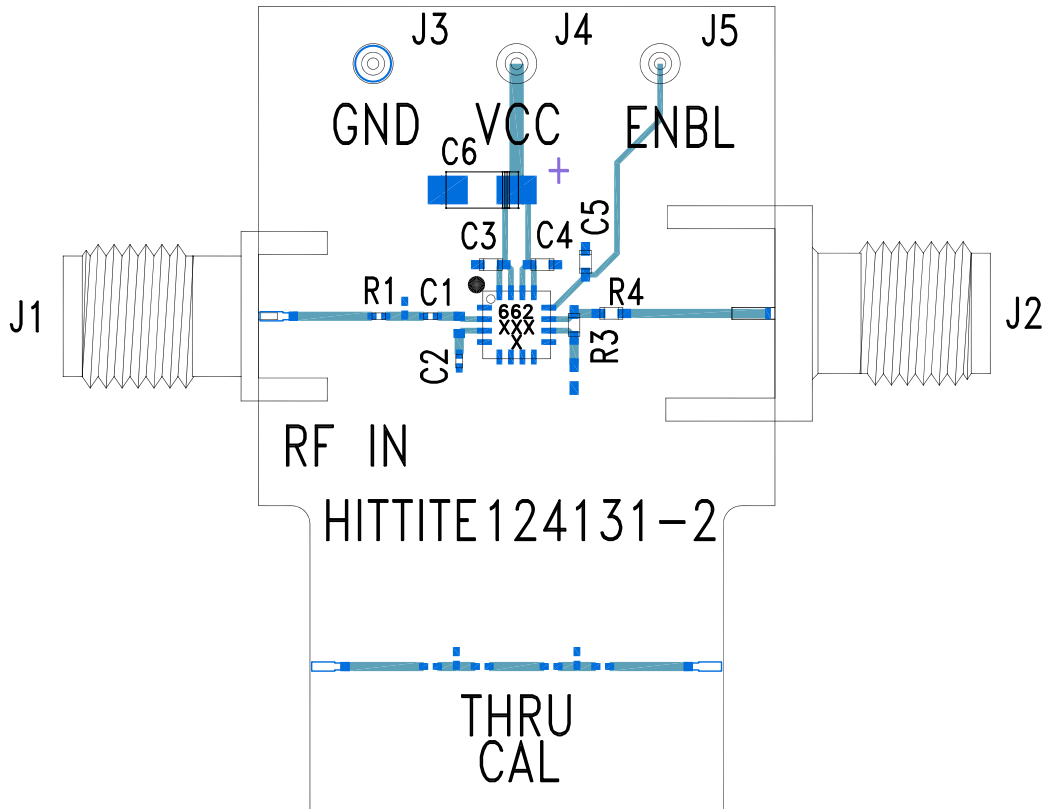

### List of Materials for Evaluation PCB 124133 [1]

| Item    | Description                                 |
|---------|---------------------------------------------|
| J1      | K-Type Connector                            |
| J2      | SMA Connector                               |
| J3 - J5 | DC Pin                                      |
| C1, C2  | 1 pF Capacitor, 0201 Pkg.                   |
| C3, C4  | 10 nF Capacitor, 0402 Pkg.                  |
| C5      | 47 pF Capacitor, 0402 Pkg.                  |
| C6      | 4.7 $\mu$ F Tantalum Capacitor, CASE A Pkg. |
| R1      | 0 $\Omega$ Resistor, 0201 Pkg.              |
| R3, R4  | 0 $\Omega$ Resistor, 0402 Pkg.              |
| U1      | HMC662LP3E Log Detector                     |
| PCB [2] | 124131 Evaluation PCB                       |

The circuit board used in the final application should use RF circuit design techniques. Signal lines should have 50 ohm impedance while the package ground leads and exposed paddle should be connected directly to the ground plane similar to that shown. A sufficient number of via holes should be used to connect the top and bottom ground planes. The evaluation circuit board shown is available from Hittite upon request.

[1] Reference this number when ordering complete evaluation PCB

[2] Circuit Board Material: Rogers 4350 or Arlon 25 FR



Компания «Life Electronics» занимается поставками электронных компонентов импортного и отечественного производства от производителей и со складов крупных дистрибьюторов Европы, Америки и Азии.

С конца 2013 года компания активно расширяет линейку поставок компонентов по направлению коаксиальный кабель, кварцевые генераторы и конденсаторы (керамические, пленочные, электролитические), за счёт заключения дистрибьюторских договоров

Мы предлагаем:

- Конкуренспособные цены и скидки постоянным клиентам.
- Специальные условия для постоянных клиентов.
- Подбор аналогов.
- Поставку компонентов в любых объемах, удовлетворяющих вашим потребностям.
- Приемлемые сроки поставки, возможна ускоренная поставка.
- Доставку товара в любую точку России и стран СНГ.
- Комплексную поставку.
- Работу по проектам и поставку образцов.
- Формирование склада под заказчика.
- Сертификаты соответствия на поставляемую продукцию (по желанию клиента).
- Тестирование поставляемой продукции.
- Поставку компонентов, требующих военную и космическую приемку.
- Входной контроль качества.
- Наличие сертификата ISO.

В составе нашей компании организован Конструкторский отдел, призванный помогать разработчикам, и инженерам.

Конструкторский отдел помогает осуществить:

- Регистрацию проекта у производителя компонентов.
- Техническую поддержку проекта.
- Защиту от снятия компонента с производства.
- Оценку стоимости проекта по компонентам.
- Изготовление тестовой платы монтаж и пусконаладочные работы.



Тел: +7 (812) 336 43 04 (многоканальный)

Email: [org@lifeelectronics.ru](mailto:org@lifeelectronics.ru)