

Dialight

microLED[®]
SMD LED Selector Guide
598 Series



Dialight

Clear Innovation

Dialight is proud to introduce a new series of microLED[®] SMD LEDs. Our new 598 Series is comprised of 10 different package styles incorporating the most popular color combinations. Single color, bi-color, tri-color and right angle package styles are all available. Common wavelengths are available in various package styles to maintain color consistency.

Packages Offered:

- 0603
- 0606
- 0805
- 1206
- 1208
- 1210

Colors Offered:

- **Green** - 525nm, 562nm
- **Yellow** - 586nm, 592nm
- **Yellow-Green** - 570nm
- **Orange** - 605nm
- **Red** - 635nm
- **Red-Orange** - 620nm
- **Blue** - 470nm

All 598 Series LEDs are RoHS compliant and many colors offered conform to the ANSI / VITA 40 standard regarding status indication.

The 598 Series is added to Dialight's impressive line of SMD products that include our 597 Series of microLED[®] SMD LEDs, 515 Series Optopipes[®], and our industry standard PRISM[®] Series of 2mm and 3mm right-angle SMD LEDs available in single, bi-level and tri-level configurations.

Dialight's new 598 Series is available through our extensive line of Sales Representatives and Distributors world-wide. For a complete listing that includes the ability to check stock status at our Distributon partners, please visit our website at www.dialight.com.

www.dialight.com



0603 SERIES PACKAGE (1.6MM X 0.8MM X 0.7MM) SINGLE COLOR

Package Outline Drawing:

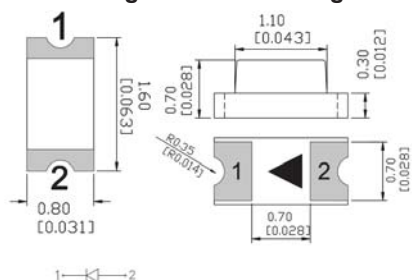

Notes 1. All dimensions are in mm [inches];
2. Tolerances are $\pm 0.1\text{mm}$ [0.004inch] unless noted.

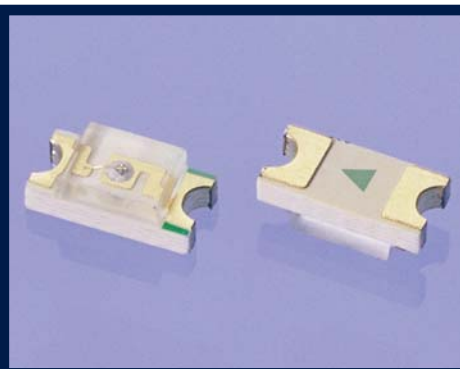

Recommended Soldering Pattern For Reflow Soldering

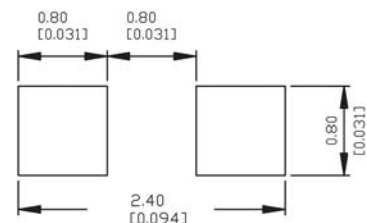

DIALIGHT P/N	EMITTED COLOR	MATERIAL	LENS COLOR	LUMINOUS INTENSITY (mcd)			DOMINANT WAVELENGTH (nm)			FORWARD VOLTAGE (V)			VIEWING ANGLE
				If = 20 ma			If = 20 ma			If = 20 ma			° DEGREES
				MIN	TYP	MAX	MIN	TYP	MAX	MIN	TYP	MAX	
598-8010-107F	RED	AllnGaP	Water Clear	30	40	80	630	635	642	1.7	2.2	2.4	140
598-8020-107F	RED-ORANGE	AllnGaP	Water Clear	120	150	200	620	625	630	1.7	2	2.4	140
598-8030-107F	ORANGE	AllnGaP	Water Clear	70	-	150	600	-	610	1.7	2	2.4	140
598-8040-107F	YELLOW	AllnGaP	Water Clear	100	130	160	590	-	595	1.7	2	2.2	140
598-8050-107F	YELLOW	AllnGaP	Water Clear	100	130	160	583	-	590	1.7	2	2.4	140
598-8060-107F	YELLOW-GREEN	AllnGaP	Water Clear	20	40	60	570	-	575	1.8	2	2.4	140
598-8070-107F	GREEN	GaP	Water Clear	10	20	40	562	-	570	1.8	2	2.4	140
598-8081-107F	GREEN	InGaP	Water Clear	220	300	400	520	523	525	3	3.2	3.5	140
598-8091-107F	BLUE	InGaP	Water Clear	90	140	160	470	473	475	2.8	3.2	3.5	140

0805 SERIES PACKAGE (2.0MM X 1.25MM X 0.7MM) SINGLE COLOR

Package Outline Drawing:

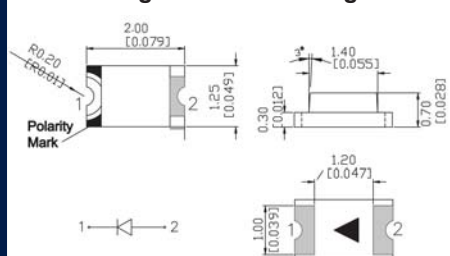

Notes 1. All dimensions are in mm [inches];
2. Tolerances are $\pm 0.1\text{mm}$ [0.004inch] unless noted.

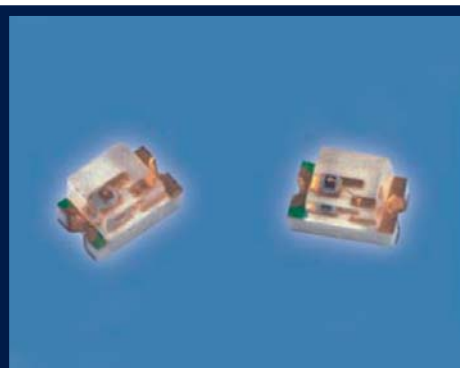

Recommended Soldering Pattern For Reflow Soldering

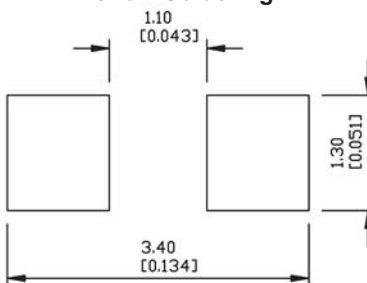

DIALIGHT P/N	EMITTED COLOR	MATERIAL	LENS COLOR	LUMINOUS INTENSITY (mcd)			DOMINANT WAVELENGTH (nm)			FORWARD VOLTAGE (V)			VIEWING ANGLE
				If = 20 ma			If = 20 ma			If = 20 ma			° DEGREES
				MIN	TYP	MAX	MIN	TYP	MAX	MIN	TYP	MAX	
598-8110-107F	RED	AllnGaP	Water Clear	30	40	80	630	635	642	1.7	2.2	2.4	140
598-8120-107F	RED-ORANGE	AllnGaP	Water Clear	120	150	200	620	625	630	1.7	2	2.4	140
598-8130-107F	ORANGE	AllnGaP	Water Clear	70	-	150	600	-	610	1.7	2	2.4	140
598-8140-107F	YELLOW	AllnGaP	Water Clear	100	130	160	590	-	595	1.7	2	2.4	140
598-8150-107F	YELLOW	AllnGaP	Water Clear	100	130	160	583	-	590	1.7	2	2.4	140
598-8160-107F	YELLOW-GREEN	AllnGaP	Water Clear	20	40	60	570	-	575	1.8	2	2.4	140
598-8170-107F	GREEN	GaP	Water Clear	10	20	40	562	-	570	1.8	2	2.4	140
598-8181-107F	GREEN	InGaP	Water Clear	220	300	400	520	523	525	3	3.2	3.5	140
598-8191-107F	BLUE	InGaP	Water Clear	90	140	160	470	473	475	2.8	3.2	3.5	140

1206 SERIES PACKAGE (3.2MM X 1.6MM X 0.7MM) SINGLE COLOR

Package Outline Drawing:

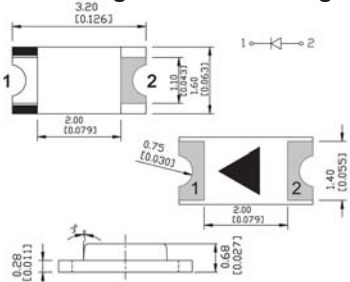

Notes 1. All dimensions are in mm [inches];
2. Tolerances are $\pm 0.1\text{mm}$ [0.004inch] unless noted.

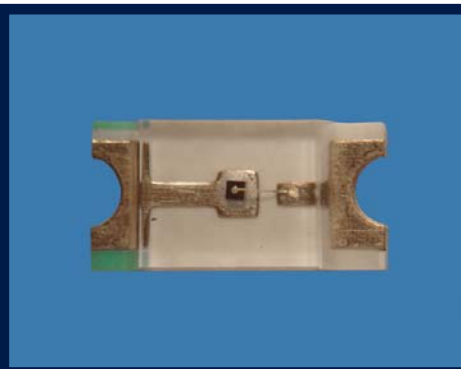

Recommended Soldering Pattern For Reflow Soldering

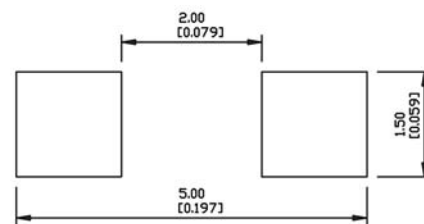

DIALIGHT P/N	EMITTED COLOR	MATERIAL	LENS COLOR	LUMINOUS INTENSITY (mcd)			DOMINANT WAVELENGTH (nm)			FORWARD VOLTAGE (V)			VIEWING ANGLE
				If = 20 ma			If = 20 ma			If = 20 ma			° DEGREES
				MIN	TYP	MAX	MIN	TYP	MAX	MIN	TYP	MAX	
598-8210-107F	RED	AllnGaP	Water Clear	30	-	80	630	635	640	1.7	2	2.4	140
598-8220-107F	RED-ORANGE	AllnGaP	Water Clear	120	150	200	620	625	630	1.7	2	2.4	140
598-8230-107F	ORANGE	AllnGaP	Water Clear	70	110	150	600	-	610	1.7	2	2.4	140
598-8240-107F	YELLOW	AllnGaP	Water Clear	100	130	160	590	-	595	1.7	2	2.4	140
598-8250-107F	YELLOW	AllnGaP	Water Clear	100	130	160	583	-	590	1.7	2	2.4	140
598-8260-107F	YELLOW-GREEN	AllnGaP	Water Clear	20	40	60	570	-	575	1.8	2	2.4	140
598-8270-107F	GREEN	GaP	Water Clear	10	20	40	562	-	570	1.8	2	2.4	140
598-8281-107F	GREEN	InGaP	Water Clear	220	300	400	520	523	525	3	3.2	3.5	140
598-8291-107F	BLUE	InGaP	Water Clear	90	140	160	470	473	475	2.8	3.2	3.5	140

1208 SERIES PACKAGE (3.2MM X 1.5MM X 1MM) SINGLE COLOR (RIGHT ANGLE)

Package Outline Drawing:

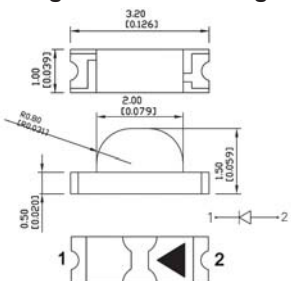

Notes 1. All dimensions are in mm [inches];
2. Tolerances are $\pm 0.1\text{mm}$ [0.004inch] unless noted.

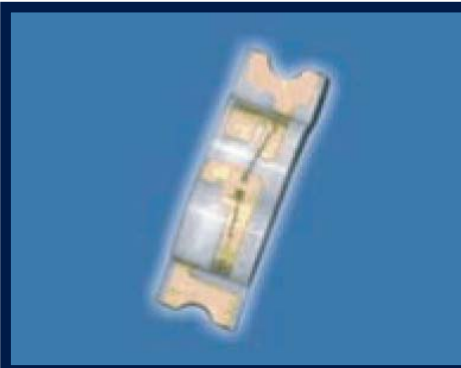

Recommended Soldering Pattern For Reflow Soldering

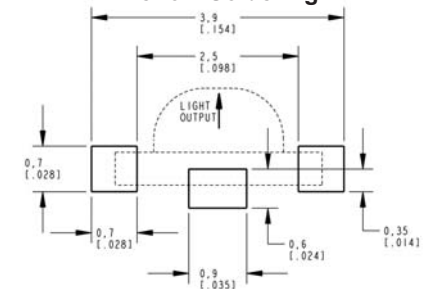

DIALIGHT P/N	EMITTED COLOR	MATERIAL	LENS COLOR	LUMINOUS INTENSITY (mcd)			DOMINANT WAVELENGTH (nm)			FORWARD VOLTAGE (V)			VIEWING ANGLE
				If = 20 ma			If = 20 ma			If = 20 ma			° DEGREES
				MIN	TYP	MAX	MIN	TYP	MAX	MIN	TYP	MAX	
598-8310-107F	RED	AllnGaP	Water Clear	-	-	70	630	635	640	1.8	2	2.4	160
598-8320-107F	RED-ORANGE	AllnGaP	Water Clear	80	120	150	620	625	630	1.8	2	2.4	160
598-8330-107F	ORANGE	AllnGaP	Water Clear	90	110	150	600	-	610	1.8	2	2.4	160
598-8340-107F	YELLOW	AllnGaP	Water Clear	100	130	160	590	-	595	1.8	2	2.4	160
598-8350-107F	YELLOW	AllnGaP	Water Clear	100	130	160	583	-	590	1.8	2	2.4	160
598-8360-107F	YELLOW-GREEN	AllnGaP	Water Clear	30	50	60	570	-	575	1.8	2	2.4	160
598-8370-107F	GREEN	GaP	Water Clear	18	28	50	562	-	570	1.8	2	2.4	160
598-8380-107F	GREEN	InGaP	Water Clear	150	220	300	520	523	525	3	3.2	3.5	160
598-8391-107F	BLUE	InGaP	Water Clear	90	140	160	470	473	475	2.8	3.2	3.5	160

0606 SERIES PACKAGE (1.6MM X 1.6MM X 0.7MM) BI-COLOR

Package Outline Drawing:

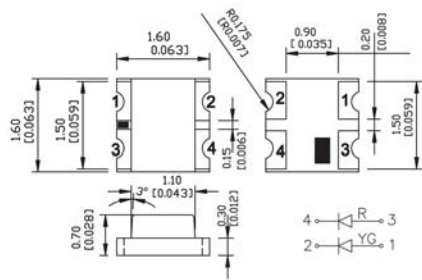

Notes 1. All dimensions are in mm [inches];
2. Tolerances are ±0.1mm [0.004inch] unless noted.

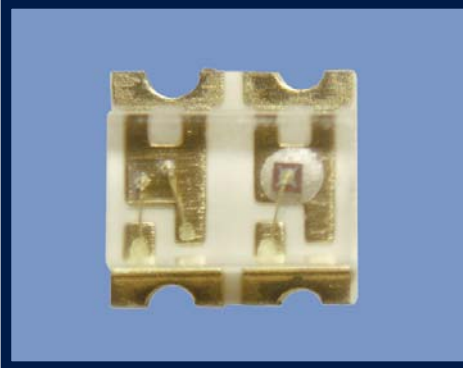

Recommended Soldering Pattern For Reflow Soldering

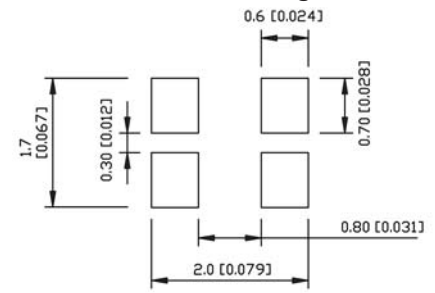

DIALIGHT P/N	EMITTED COLOR	MATERIAL	LENS COLOR	LUMINOUS INTENSITY (mcd)			DOMINANT WAVELENGTH			FORWARD VOLTAGE (V)			VIEWING ANGLE
				If = 20 ma			If = 20 ma			If = 20 ma			° DEGREES
				MIN	TYP	MAX	MIN	TYP	MAX	MIN	TYP	MAX	
598-8410-207F	RED	AllnGaP	Water Clear	40	60	80	630	635	645	1.8	2	2.4	140
	GREEN	AllnGaP	Water Clear	30	40	50	560	565	570	1.8	2	2.4	140
598-8440-207F	YELLOW	AllnGaP	Water Clear	120	135	150	587	590	592	1.8	2	2.4	140
	GREEN	AllnGaP	Water Clear	35	50	65	565	570	575	1.8	2	2.4	140
598-8450-207F	YELLOW	AllnGaP	Water Clear	80	120	150	587	590	592	1.8	2	2.4	140
	GREEN	InGaN	Water Clear	90	120	140	525	528	530	2.7	3.2	3.5	140
598-8460-207F	YELLOW	AllnGaP	Water Clear	120	135	150	587	590	592	1.8	2	2.4	140
	RED	AllnGaP	Water Clear	40	50	60	630	640	645	1.8	2.2	2.4	140

1208 SERIES PACKAGE (3.2MM X 1.5MM X 1.0MM) BI-COLOR (RIGHT ANGLE)

Package Outline Drawing:

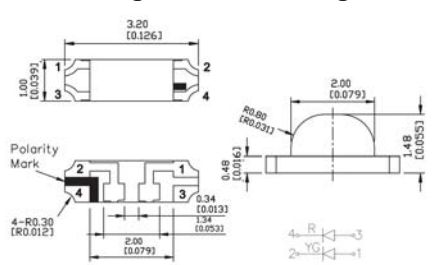

Notes 1. All dimensions are in mm [inches];
2. Tolerances are ±0.1mm [0.004inch] unless noted.



Recommended Soldering Pattern For Reflow Soldering

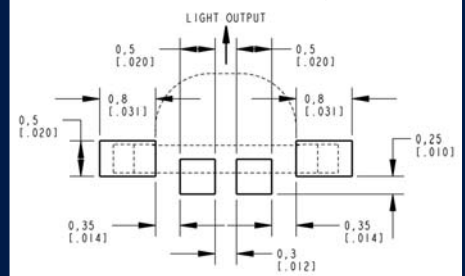

DIALIGHT P/N	EMITTED COLOR	MATERIAL	LENS COLOR	LUMINOUS INTENSITY (mcd)			DOMINANT WAVELENGTH (nm)			FORWARD VOLTAGE (V)			VIEWING ANGLE
				If = 20 ma			If = 20 ma			If = 20 ma			° DEGREES
				MIN	TYP	MAX	MIN	TYP	MAX	MIN	TYP	MAX	
598-8510-207F	RED	AllnGaP	Water Clear	40	60	80	630	635	645	1.8	2	2.4	160
	GREEN	AllnGaP	Water Clear	30	40	50	560	565	570	1.8	2	2.4	160
598-8520-207F	RED-ORANGE	AllnGaP	Water Clear	80	110	150	620	625	630	1.8	2	2.4	160
	GREEN	AllnGaP	Water Clear	30	40	50	560	568	570	1.8	2	2.4	160
598-8540-207F	YELLOW	AllnGaP	Water Clear	90	110	150	587	590	592	1.8	2	2.4	160
	GREEN	AllnGaP	Water Clear	30	40	60	560	565	570	1.8	2	2.4	160
598-8560-207F	YELLOW	AllnGaP	Water Clear	120	135	150	587	590	592	1.8	2.2	2.4	160
	RED	AllnGaP	Water Clear	40	50	60	630	635	645	1.8	2.2	2.4	160

1210 SERIES PACKAGE (3.2MM X 2.7MM X 0.7MM) BI-COLOR

Package Outline Drawing:

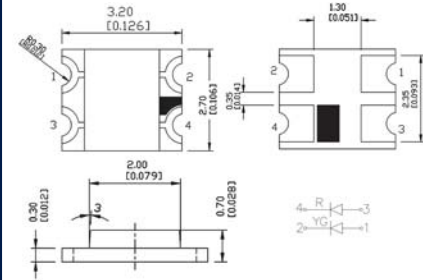

Notes 1. All dimensions are in mm [inches];
2. Tolerances are $\pm 0.1\text{mm}$ [0.004inch] unless noted.

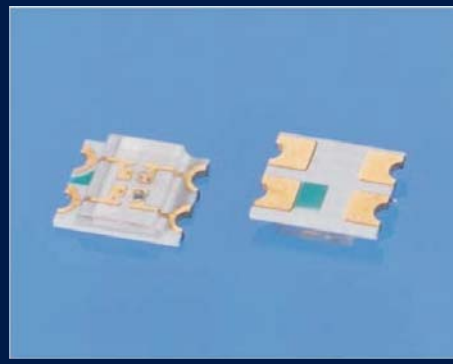

Recommended Soldering Pattern For Reflow Soldering

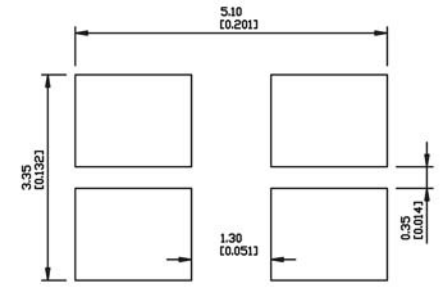

DIALIGHT P/N	EMITTED COLOR	MATERIAL	LENS COLOR	LUMINOUS INTENSITY (mcd)			DOMINANT WAVELENGTH (nm)			FORWARD VOLTAGE (V)			VIEWING ANGLE
				If = 20 ma			If = 20 ma			If = 20 ma			° DEGREES
				MIN	TYP	MAX	MIN	TYP	MAX	MIN	TYP	MAX	
598-8610-207F	RED	AllnGaP	Water Clear	40	60	80	630	635	645	1.8	2	2.4	140
	GREEN	AllnGaP	Water Clear	30	40	50	562	568	570	1.8	2	2.4	140
598-8621-207F	RED-ORANGE	AllnGaP	Water Clear	80	100	120	620	625	630	1.8	2	2.4	140
	GREEN	InGaN	Water Clear	200	220	240	520	525	530	2.7	3.2	3.5	140
598-8640-207F	YELLOW	AllnGaP	Water Clear	90	110	150	587	590	592	1.8	2	2.4	140
	GREEN	AllnGaP	Water Clear	30	40	50	562	568	570	1.8	2	2.4	140
598-8660-207F	YELLOW	AllnGaP	Water Clear	90	110	150	587	590	592	1.8	2.2	2.4	140
	RED	AllnGaP	Water Clear	40	60	80	630	635	645	1.8	2.2	2.4	140

1210 SERIES PACKAGE (3.2MM X 2.7MM X 0.7MM) TRI COLOR

Package Outline Drawing:

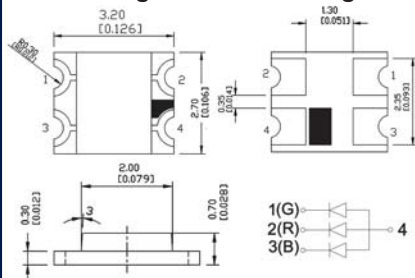

Notes 1. All dimensions are in mm [inches];
2. Tolerances are $\pm 0.1\text{mm}$ [0.004inch] unless noted.



Recommended Soldering Pattern For Reflow Soldering

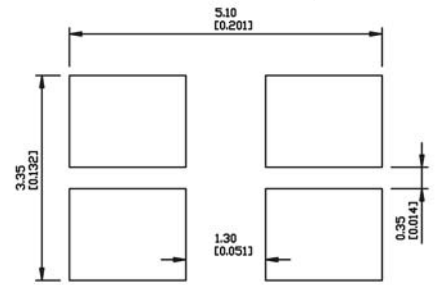

DIALIGHT P/N	EMITTED COLOR	MATERIAL	LENS COLOR	LUMINOUS INTENSITY (mcd)			DOMINANT WAVELENGTH (nm)			FORWARD VOLTAGE (V)			VIEWING ANGLE
				If = 20 ma			If = 20 ma			If = 20 ma			° DEGREES
				MIN	TYP	MAX	MIN	TYP	MAX	MIN	TYP	MAX	
598-8610-307F	RED	AllnGaP	Water Clear	40	60	80	630	635	645	1.9	2	2.2	140
	GREEN	InGaN	Water Clear	90	120	220	520	525	530	2.8	3.2	3.5	140
	BLUE	InGaN	Water Clear	60	90	140	465	470	475	2.8	3.2	3.5	140
598-8920-307F	RED-ORANGE	AllnGaP	Water Clear	90	120	150	620	625	630	1.9	2	2.2	140
	GREEN	InGaN	Water Clear	90	150	220	520	525	530	3	3.2	3.5	140
	BLUE	InGaN	Water Clear	30	60	90	465	470	475	3	3.2	3.5	140
598-8940-307F	YELLOW	AllnGaP	Water Clear	90	110	150	587	590	592	1.8	2.2	2.4	140
	GREEN	InGaN	Water Clear	150	220	300	520	525	530	2.8	3.2	3.5	140
	BLUE	InGaN	Water Clear	60	90	140	465	470	475	2.8	3.2	3.5	140

0606 SERIES PACKAGE (1.6MM X 1.6MM X 0.7MM) TRI-COLOR

Package Outline Drawing:

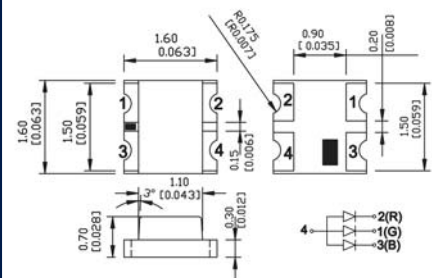

Notes 1. All dimensions are in mm [inches];
2. Tolerances are ±0.1mm [0.004inch] unless noted.



Recommended Soldering Pattern For Reflow Soldering

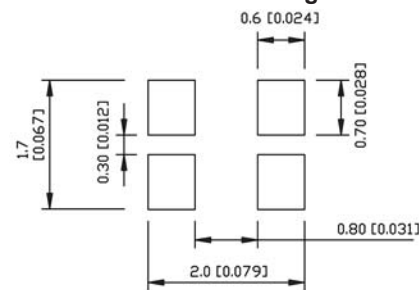

DIALIGHT P/N	EMITTED COLOR	MATERIAL	LENS COLOR	LUMINOUS INTENSITY (mcd)			DOMINANT WAVELENGTH (nm)			FORWARD VOLTAGE (V)			VIEWING ANGLE ° DEGREES
				If = 20 ma			If = 20 ma			If = 20 ma			
				MIN	TYP	MAX	MIN	TYP	MAX	MIN	TYP	MAX	
598-8710-307F	RED	AllInGaP	Water Clear	40	60	80	630	635	645	1.9	2	2.2	140
	GREEN	InGaN	Water Clear	90	120	220	520	525	530	2.8	3.2	3.5	140
	BLUE	InGaN	Water Clear	60	90	140	465	470	475	2.8	3.2	3.5	140
598-8720-307F	RED-ORANGE	AllInGaP	Water Clear	60	80	150	620	625	630	1.8	2.2	2.4	140
	GREEN	InGaN	Water Clear	90	150	220	520	525	530	2.8	3	3.5	140
	BLUE	InGaN	Water Clear	40	60	90	465	470	475	3	3.2	3.5	140
598-8740-307F	YELLOW	AllInGaP	Water Clear	90	110	150	587	590	595	1.8	2.2	2.4	140
	GREEN	InGaN	Water Clear	150	220	300	520	525	530	2.8	3.2	3.5	140
	BLUE	InGaN	Water Clear	60	90	140	465	470	475	2.8	3.2	3.5	140

1208 SERIES PACKAGE (3.2MM X 1.5MM X 1.0MM) TRI-COLOR (RIGHT ANGLE)

Package Outline Drawing:

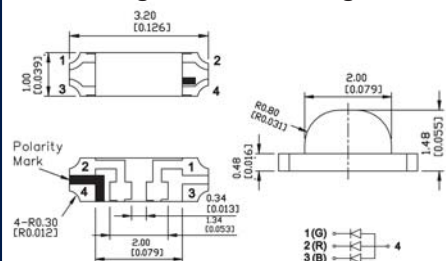

Notes 1. All dimensions are in mm [inches];
2. Tolerances are ±0.1mm [0.004inch] unless noted.



Recommended Soldering Pattern For Reflow Soldering

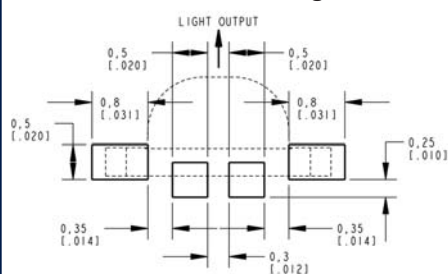

DIALIGHT P/N	EMITTED COLOR	MATERIAL	LENS COLOR	LUMINOUS INTENSITY (mcd)			DOMINANT WAVELENGTH (nm)			FORWARD VOLTAGE (V)			VIEWING ANGLE ° DEGREES
				If = 20 ma			If = 20 ma			If = 20 ma			
				MIN	TYP	MAX	MIN	TYP	MAX	MIN	TYP	MAX	
598-8810-307F	RED	AllInGaP	Water Clear	40	60	80	630	635	645	1.8	2.2	2.4	160
	GREEN	InGaN	Water Clear	90	120	220	520	525	530	2.8	3.2	3.4	160
	BLUE	InGaN	Water Clear	60	90	140	465	470	475	2.8	3.2	3.4	160
598-8820-307F	RED-ORANGE	AllInGaP	Water Clear	90	120	150	620	625	630	1.8	2	2.4	160
	GREEN	InGaN	Water Clear	150	220	300	520	525	530	3	3.2	3.5	160
	BLUE	InGaN	Water Clear	60	90	140	465	470	475	3	3.2	3.5	160
598-8840-307F	YELLOW	AllInGaP	Water Clear	90	110	150	587	590	595	1.8	2.2	2.4	160
	GREEN	InGaN	Water Clear	150	220	300	520	525	530	2.8	3.2	3.5	160
	BLUE	InGaN	Water Clear	60	90	140	465	470	475	2.8	3.2	3.5	160

OPTICAL AND ELECTRICAL CHARACTERISTICS CURVES

RED 630-642NM, RED-ORANGE 620-630NM, ORANGE 600-610NM, YELLOW 590-595NM, YELLOW 583-590NM, YELLOW GREEN 570-575NM, GREEN 562-570NM

FORWARD VOLTAGE VS FORWARD CURRENT (Ta=25°C)

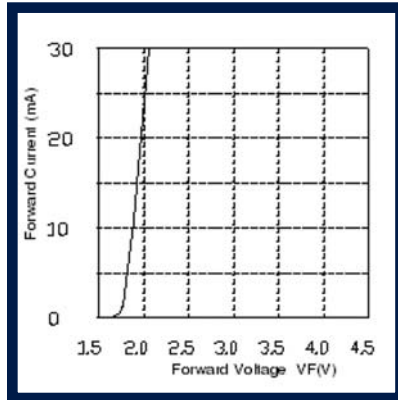

RELATIVE INTENSITY VS FORWARD CURRENT (Ta=25°C)

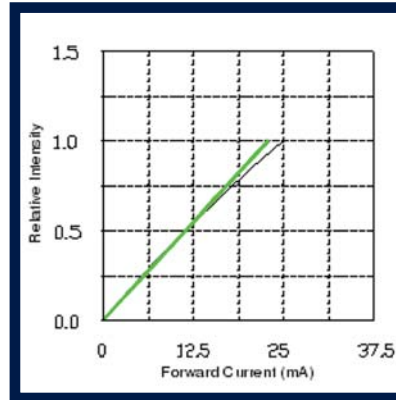

Single Colors
Bi-Colors
Tri-Colors



Single Colors

Bi-Colors
Tri-Colors



DERATING

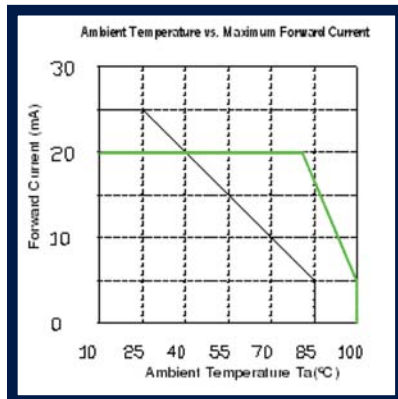

RELATIVE INTENSITY VS AMBIENT TEMPERATURE

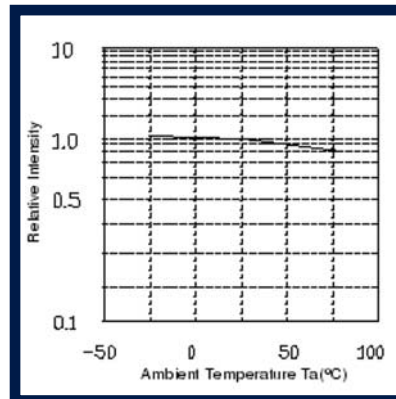

Single Colors



Bi-Colors
Tri-Colors



Single Colors
Bi-Colors
Tri-Colors



GREEN 520-525NM, BLUE 470-475NM

FORWARD VOLTAGE VS FORWARD CURRENT (Ta=25°C)

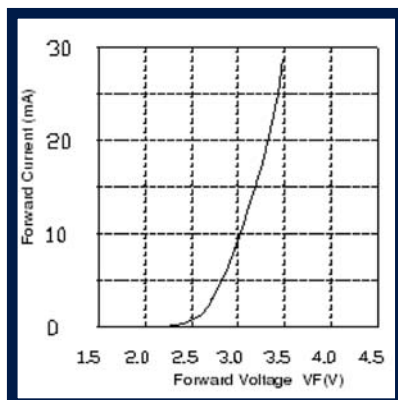

RELATIVE INTENSITY VS FORWARD CURRENT (Ta=25°C)

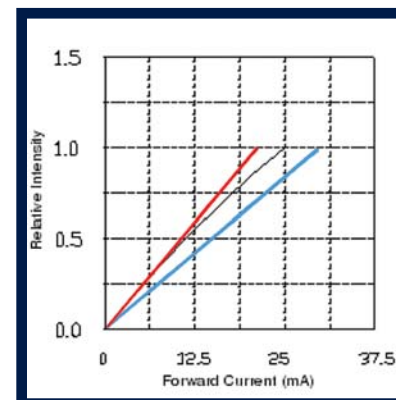

Single Colors
Bi-Colors
Tri-Colors



Single Colors

0606 Bi-Color
0606 Tri-Color
1208 Tri-Color
1210 Bi-Color
1210 Tri-Color



1208 Bi-Color



DERATING

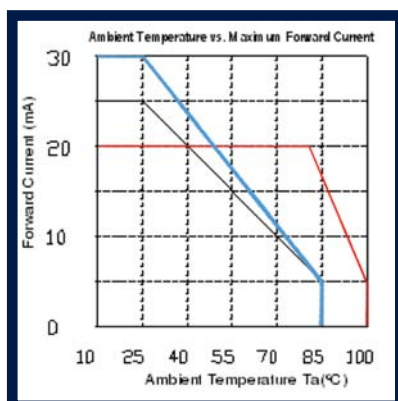

RELATIVE INTENSITY VS AMBIENT TEMPERATURE

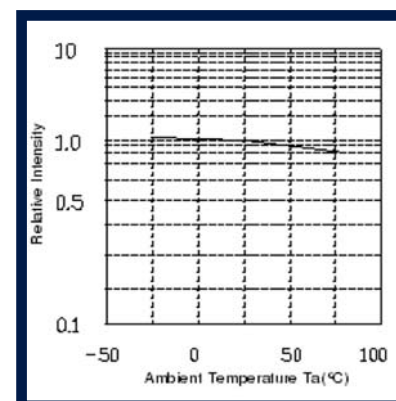

Single Colors



0606 Bi-Color
0606 Tri-Color
1208 Tri-Color
1210 Bi-Color
1210 Tri-Color



1208 Bi-Color



Single Colors
Bi-Colors
Tri-Colors



REFLOW PROFILE AND SOLDERING CONDITIONS

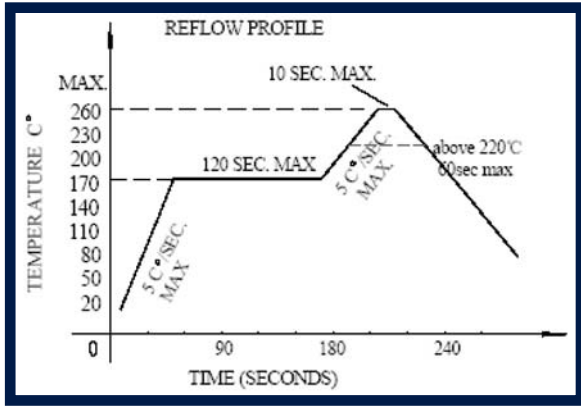

REFLOW SOLDERING		HAND SOLDERING	
Pre-heat	160~180°C	Temperature	300°C Max.
Pre-heat time	120 seconds Max.	-	-
Peak temperature	260°C Max.	Soldering time	3 second Max (one time only)
Soldering time	10 seconds Max.	-	-
Condition	Refer to temperature profile	-	-

PACKAGING SPECIFICATIONS

DIMENSIONS IN MM [INCHES]

0603 SINGLE COLOR PACKAGE

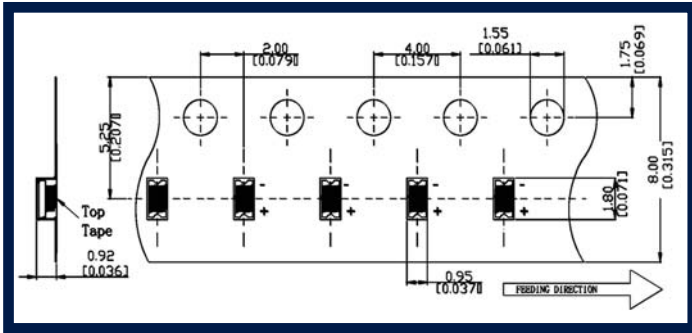

0805 SINGLE COLOR PACKAGE

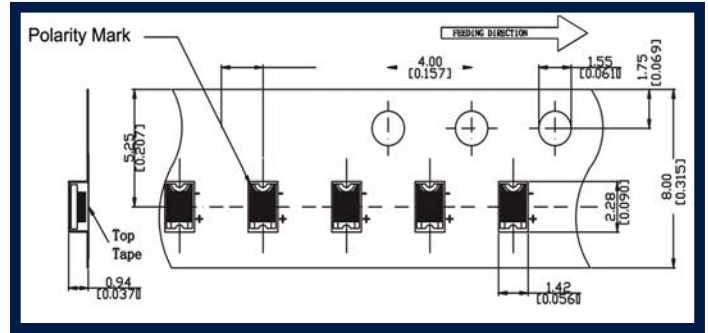

1206 SINGLE COLOR PACKAGE

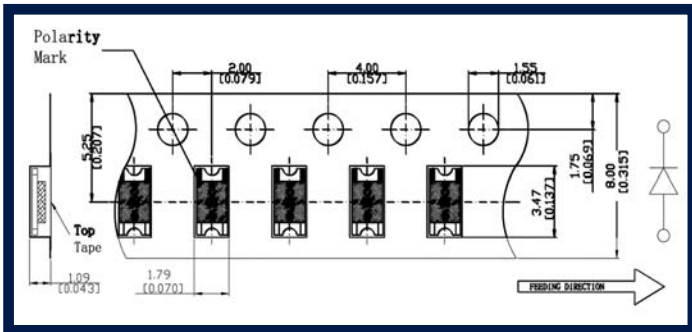

1208 SINGLE COLOR PACKAGE

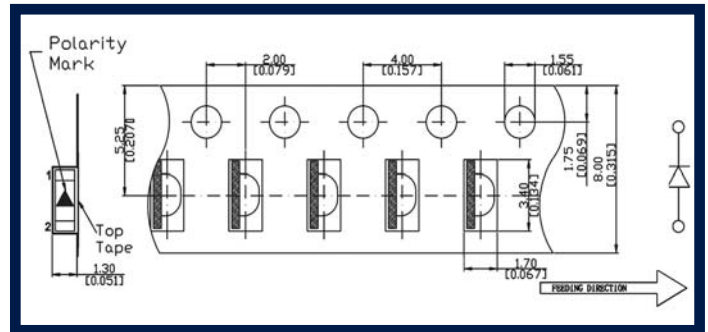

DIMENSIONS OF REEL

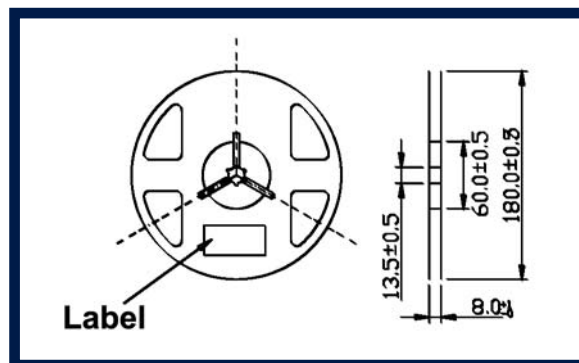

0606 BI-COLOR PACKAGE

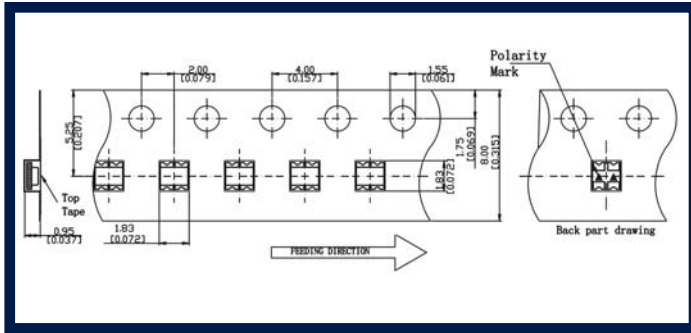

1208 BI-COLOR PACKAGE

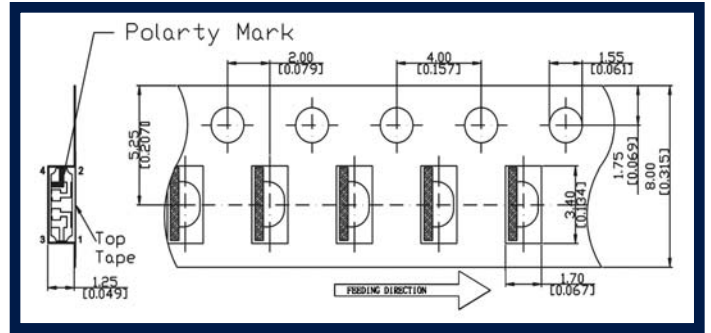

1210 BI-COLOR PACKAGE

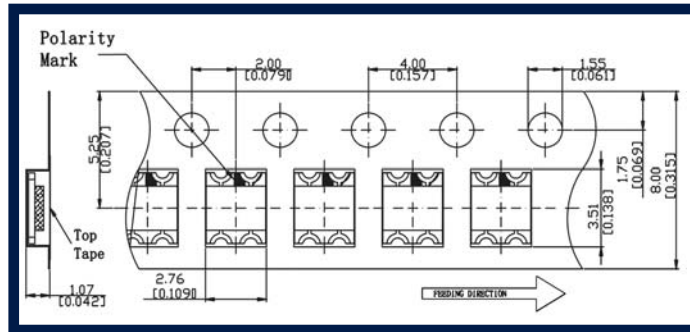

0606 TRI-COLOR PACKAGE

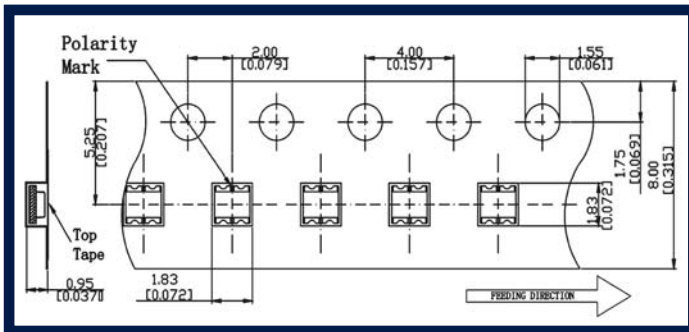

1208 TRI-COLOR PACKAGE

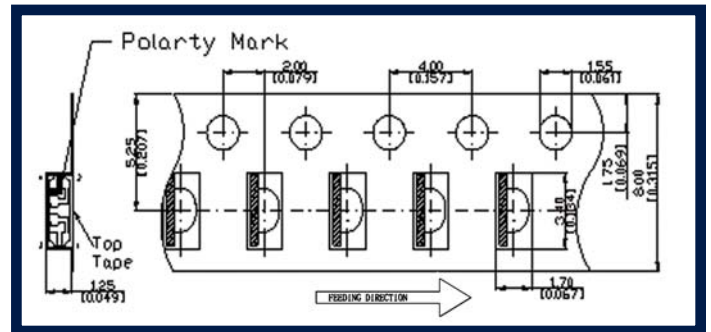

1210 TRI-COLOR PACKAGE

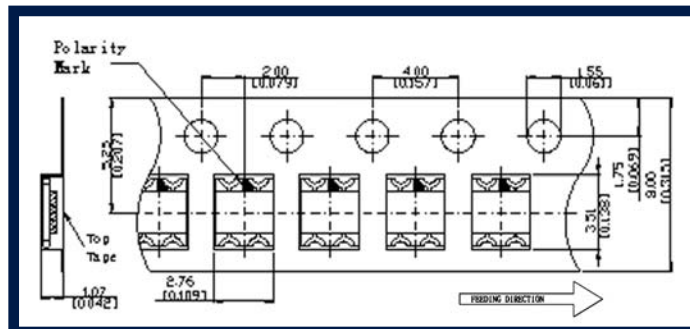

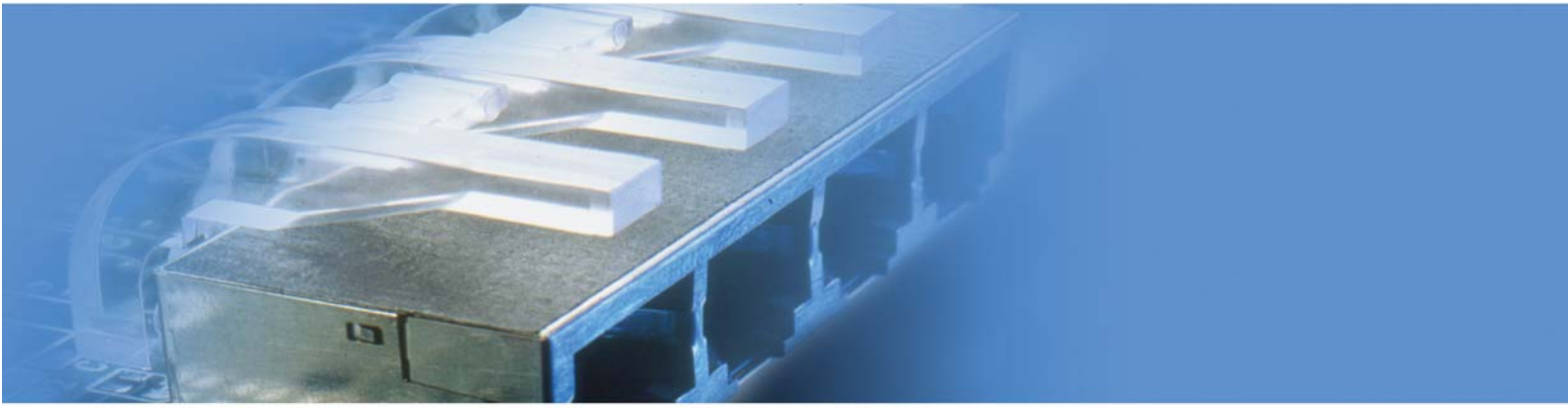

FROM INDICATION TO ILLUMINATION: BOARD LEVEL INDICATION PRODUCTS

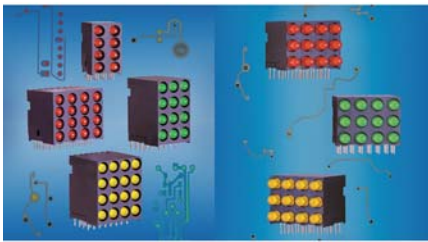

Through Hole CBI[®]
Circuit Board Indicators

- ▷ Housed LEDs in variety of configurations including:
Right angle, vertical & horizontal ganged arrays in single bi, tri, and quad blocks
- ▷ 2mm , 3mm & 5mm
- ▷ Perfect for direct view or backlighting applications
- ▷ Variety of colors and LED types including:
Single & bi-color, diffused, water-clear, tinted, super-bright, & high efficiency
- ▷ Over 2500 variations, with custom LED placement available
- ▷ RoHS compliant

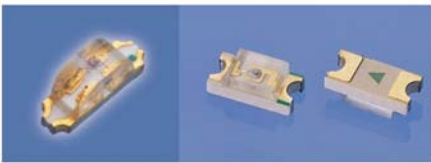

598 Series microLED[®]
Surface Mount LEDs

- ▷ Chip LED in 10 different package styles including:
0603 0606 0805 1206 1208 1210
- ▷ Single color, bi color, tri color and right angle
- ▷ Using latest in AlInGaP & InGaN technology
- ▷ Cost competitive pricing
- ▷ Also see 597 series for additional Chip LED and PLCC packages
- ▷ Selector guide available
- ▷ RoHS compliant

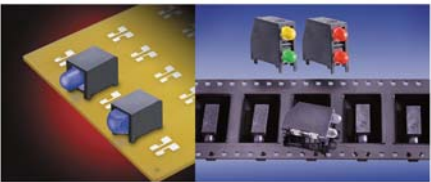

Prism[®] Series
Right Angle SMT

- ▷ Surface mountable solution with integrated optics
- ▷ 2mm & 3mm LEDs
- ▷ Tape and reel / pick and place compatible
- ▷ Can withstand higher temp RoHS solder process and eliminates need for secondary optics or separate process
- ▷ Available with square or round lens, and also in low current version
- ▷ Packaged in single, bi & tri level configurations
- ▷ RoHS compliant

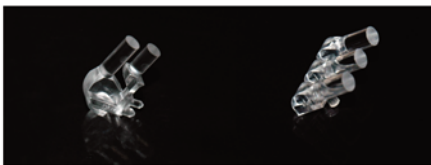

Optopipe[®] Light Pipes
for use with microLED[®] SMT

- ▷ Light pipes act as conduit for directing light from SMT to viewing angles
- ▷ Right angle and vertical available in almost 200 sizes and shapes
- ▷ Provides ESD protection
- ▷ Allows edge lighting over and around a variety of components including SFP assemblies and RJ45 jacks
- ▷ UL 94V0
- ▷ Standard and custom available
- ▷ RoHS compliant



Dialight



■ *Dialight Corporate Office*
1501 Rt 34 South
Farmingdale, NJ 07727 USA
Tel: +1.732.919.3119
Fax: +1.732.751.5778
Email: info@dialight.com

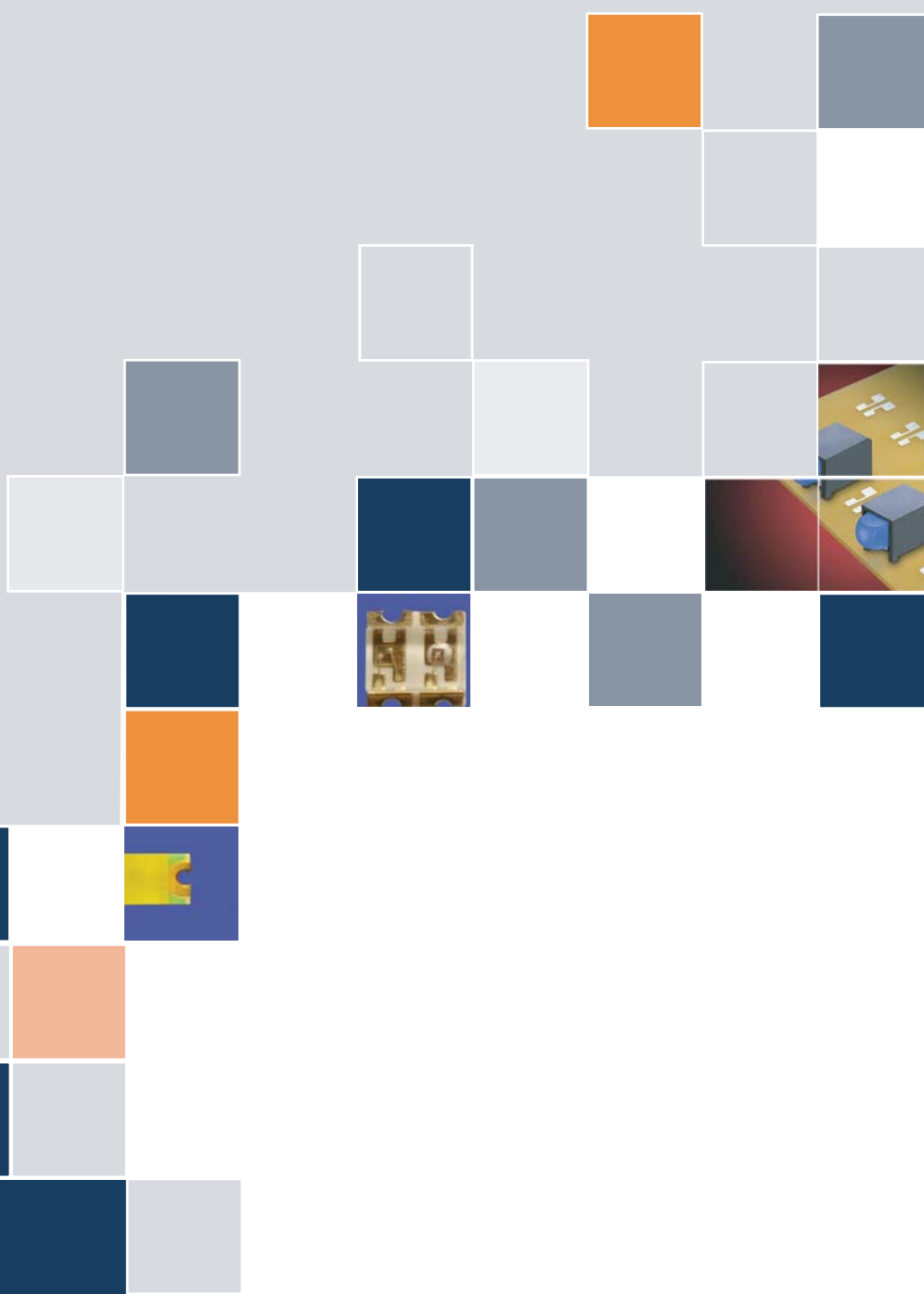

Компания «Life Electronics» занимается поставками электронных компонентов импортного и отечественного производства от производителей и со складов крупных дистрибьюторов Европы, Америки и Азии.

С конца 2013 года компания активно расширяет линейку поставок компонентов по направлению коаксиальный кабель, кварцевые генераторы и конденсаторы (керамические, пленочные, электролитические), за счёт заключения дистрибьюторских договоров

Мы предлагаем:

- Конкуренспособные цены и скидки постоянным клиентам.
- Специальные условия для постоянных клиентов.
- Подбор аналогов.
- Поставку компонентов в любых объемах, удовлетворяющих вашим потребностям.
- Приемлемые сроки поставки, возможна ускоренная поставка.
- Доставку товара в любую точку России и стран СНГ.
- Комплексную поставку.
- Работу по проектам и поставку образцов.
- Формирование склада под заказчика.
- Сертификаты соответствия на поставляемую продукцию (по желанию клиента).
- Тестирование поставляемой продукции.
- Поставку компонентов, требующих военную и космическую приемку.
- Входной контроль качества.
- Наличие сертификата ISO.

В составе нашей компании организован Конструкторский отдел, призванный помогать разработчикам, и инженерам.

Конструкторский отдел помогает осуществить:

- Регистрацию проекта у производителя компонентов.
- Техническую поддержку проекта.
- Защиту от снятия компонента с производства.
- Оценку стоимости проекта по компонентам.
- Изготовление тестовой платы монтаж и пусконаладочные работы.



Тел: +7 (812) 336 43 04 (многоканальный)

Email: org@lifeelectronics.ru