

ADG511/ADG512/ADG513

FEATURES

+3 V, +5 V or ± 5 V Power Supplies
Ultralow Power Dissipation ($<0.5 \mu\text{W}$)
Low Leakage ($<100 \text{ pA}$)
Low On Resistance ($<50 \Omega$)
Fast Switching Times
Low Charge Injection
TTL/CMOS Compatible
16-Lead DIP or SOIC Package

APPLICATIONS

Battery-Powered Instruments
Single Supply Systems
Remote Powered Equipment
5 V Supply Systems
Computer Peripherals such as Disk Drives
Precision Instrumentation
Audio and Video Switching
Automatic Test Equipment
Precision Data Acquisition
Sample Hold Systems
Communication Systems
Compatible with ± 5 V Supply DACs and ADCs such as
AD7840/AD7848, AD7870/AD7871/AD7872/AD7874/
AD7875/AD7876/AD7878

GENERAL DESCRIPTION

The ADG511, ADG512 and ADG513 are monolithic CMOS ICs containing four independently selectable analog switches. These switches feature low, well-controlled on resistance and wide analog signal range, making them ideal for precision analog signal switching.

These switch arrays are fabricated using Analog Devices' advanced linear compatible CMOS (LC²MOS) process which offers the additional benefits of low leakage currents, ultralow power dissipation and low capacitance for fast switching speeds with minimum charge injection. These features make the ADG511, ADG512 and ADG513 the optimum choice for a wide variety of signal switching tasks in precision analog signal processing and data acquisition systems.

The ability to operate from single +3 V, +5 V or ± 5 V bipolar supplies make the ADG511, ADG512 and ADG513 perfect for use in battery-operated instruments, 4–20 mA loop systems and with the new generation of DACs and ADCs from Analog Devices. The use of 5 V supplies and reduced operating currents give much lower power dissipation than devices operating from ± 15 V supplies.

REV. C

Information furnished by Analog Devices is believed to be accurate and reliable. However, no responsibility is assumed by Analog Devices for its use, nor for any infringements of patents or other rights of third parties that may result from its use. No license is granted by implication or otherwise under any patent or patent rights of Analog Devices.

FUNCTIONAL BLOCK DIAGRAMS

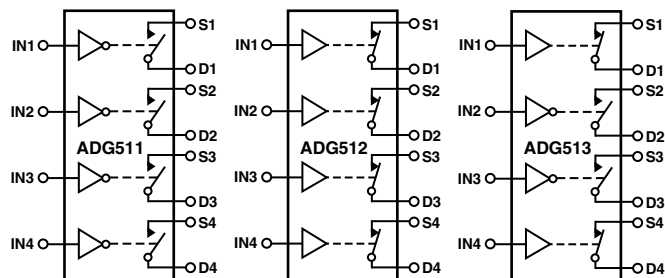

SWITCHES SHOWN FOR A LOGIC "1" INPUT

The ADG511, ADG512 and ADG513 contain four independent SPST switches. The ADG511 and ADG512 differ in that the digital control logic is inverted. The ADG511 switch is turned on with a logic low on the appropriate control input, while a logic high is required for the ADG512. The ADG513 contains two switches whose digital control logic is similar to that of the ADG511 while the logic is inverted in the remaining two switches.

PRODUCT HIGHLIGHTS

- 5 Volt Single Supply Operation**
 The ADG511/ADG512/ADG513 offers high performance, including low on resistance and wide signal range, fully specified and guaranteed with +3 V, ± 5 V as well as +5 V supply rails.
- Ultralow Power Dissipation**
 CMOS construction ensures ultralow power dissipation.
- Low R_{ON}**
- Break-Before-Make Switching**
 Switches are guaranteed to have break-before-make operation. This allows multiple outputs to be tied together for multiplexer applications without the possibility of momentary shorting between channels.

ADG511/ADG512/ADG513—SPECIFICATIONS¹

Dual Supply ($V_{DD} = +5\text{ V} \pm 10\%$, $V_{SS} = -5\text{ V} \pm 10\%$, $GND = 0\text{ V}$, unless otherwise noted)

| Parameter | B Versions | | T Version | | Unit | Test Conditions/Comments |
|--|---|-----------------------------------|---|-----------------------------------|--|---|
| | 25°C | -40°C to +85°C | 25°C | -55°C to +125°C | | |
| ANALOG SWITCH Analog Signal Range R_{ON} | 30 | V_{DD} to V_{SS} 50 | 30 | V_{DD} to V_{SS} 50 | V Ω typ Ω max | $V_D = \pm 3.5\text{ V}$, $I_S = -10\text{ mA}$; $V_{DD} = +4.5\text{ V}$, $V_{SS} = -4.5\text{ V}$ |
| LEAKAGE CURRENTS Source OFF Leakage I_S (OFF) Drain OFF Leakage I_D (OFF) Channel ON Leakage I_D , I_S (ON) | ± 0.025 ± 0.1 ± 0.025 ± 0.1 ± 0.05 ± 0.2 | ± 2.5 ± 2.5 ± 5 | ± 0.025 ± 0.1 ± 0.025 ± 0.1 ± 0.05 ± 0.2 | ± 2.5 ± 2.5 ± 5 | nA typ nA max nA typ nA max nA typ nA max | $V_{DD} = +5.5\text{ V}$, $V_{SS} = -5.5\text{ V}$ $V_D = \pm 4.5\text{ V}$, $V_S = \mp 4.5\text{ V}$; Test Circuit 2 $V_D = \pm 4.5\text{ V}$, $V_S = \mp 4.5\text{ V}$; Test Circuit 2 $V_D = V_S = \pm 4.5\text{ V}$; Test Circuit 3 |
| DIGITAL INPUTS Input High Voltage, V_{INH} Input Low Voltage, V_{INL} Input Current I_{INL} or I_{INH} | | 2.4 0.8 ± 0.1 | | 2.4 0.8 ± 0.1 | V min V max μA typ μA max | $V_{IN} = V_{INL}$ or V_{INH} |
| DYNAMIC CHARACTERISTICS² t_{ON} t_{OFF} Break-Before-Make Time Delay, t_D (ADG513 Only) Charge Injection OFF Isolation Channel-to-Channel Crosstalk C_S (OFF) C_D (OFF) C_D , C_S (ON) | 200 120 100 11 68 85 9 9 35 | 375 150 | 200 120 100 11 68 85 9 9 35 | 375 150 | ns typ ns max ns typ ns max ns typ pC typ dB typ dB typ pF typ pF typ pF typ | $R_L = 300\ \Omega$, $C_L = 35\text{ pF}$; $V_S = \pm 3\text{ V}$; Test Circuit 4 $R_L = 300\ \Omega$, $C_L = 35\text{ pF}$; $V_S = \pm 3\text{ V}$; Test Circuit 4 $R_L = 300\ \Omega$, $C_L = 35\text{ pF}$; $V_{S1} = V_{S2} = 3\text{ V}$; Test Circuit 5 Test Circuit 6 $R_L = 50\ \Omega$, $C_L = 5\text{ pF}$, $f = 1\text{ MHz}$; Test Circuit 7 $R_L = 50\ \Omega$, $C_L = 5\text{ pF}$, $f = 1\text{ MHz}$; Test Circuit 8 $f = 1\text{ MHz}$ $f = 1\text{ MHz}$ $f = 1\text{ MHz}$ |
| POWER REQUIREMENTS V_{DD} V_{SS} I_{DD} I_{SS} | | +4.5/5.5 -4.5/-5.5 1 1 | | +4.5/5.5 -4.5/-5.5 1 1 | V min/max V min/max μA typ μA max μA typ μA max | $V_{DD} = +5.5\text{ V}$, $V_{SS} = -5.5\text{ V}$ Digital Inputs = 0 V or 5 V |

NOTES

¹Temperature ranges are as follows: B Versions -40°C to +85°C; T Version -55°C to +125°C.

²Guaranteed by design, not subject to production test.

Specifications subject to change without notice.

Single Supply ($V_{DD} = 5\text{ V} \pm 10\%$, $V_{SS} = 0\text{ V}$, $GND = 0\text{ V}$, unless otherwise noted)

| Parameter | B Versions | | T Version | | Unit | Test Conditions/Comments |
|---|---|-----------------------------------|---|-----------------------------------|--|--|
| | 25°C | -40°C to +85°C | 25°C | -55°C to +125°C | | |
| ANALOG SWITCH Analog Signal Range R_{ON} | 45 | 0 V to V_{DD} 75 | 45 | 0 V to V_{DD} 75 | V Ω typ Ω max | $V_D = 3.5\text{ V}$, $I_S = -10\text{ mA}$; $V_{DD} = 4.5\text{ V}$ |
| LEAKAGE CURRENTS Source OFF Leakage I_S (OFF) Drain OFF Leakage I_D (OFF) Channel ON Leakage I_D , I_S (ON) | ± 0.025 ± 0.1 ± 0.025 ± 0.1 ± 0.05 ± 0.2 | ± 2.5 ± 2.5 ± 5 | ± 0.025 ± 0.1 ± 0.025 ± 0.1 ± 0.05 ± 0.2 | ± 2.5 ± 2.5 ± 5 | nA typ nA max nA typ nA max nA typ nA max | $V_{DD} = 5.5\text{ V}$ $V_D = 4.5/1\text{ V}$, $V_S = 1/4.5\text{ V}$; Test Circuit 2 $V_D = 4.5/1\text{ V}$, $V_S = 1/4.5\text{ V}$; Test Circuit 2 $V_D = V_S = 4.5\text{ V}/1\text{ V}$; Test Circuit 3 |
| DIGITAL INPUTS Input High Voltage, V_{INH} Input Low Voltage, V_{INL} Input Current I_{INL} or I_{INH} | | 2.4 0.8 ± 0.1 | | 2.4 0.8 ± 0.1 | V min V max μA typ μA max | $V_{IN} = V_{INL}$ or V_{INH} |
| DYNAMIC CHARACTERISTICS ² t_{ON} t_{OFF} Break-Before-Make Time Delay, t_D (ADG513 Only) Charge Injection OFF Isolation Channel-to-Channel Crosstalk C_S (OFF) C_D (OFF) C_D , C_S (ON) | 250 50 200 16 68 85 9 9 35 | 500 100 | 250 50 200 16 68 85 9 9 35 | 500 100 | ns typ ns max ns typ ns max ns typ pC typ dB typ dB typ pF typ pF typ pF typ | $R_L = 300\ \Omega$, $C_L = 35\text{ pF}$; $V_S = 2\text{ V}$; Test Circuit 4 $R_L = 300\ \Omega$, $C_L = 35\text{ pF}$; $V_S = 2\text{ V}$; Test Circuit 4 $R_L = 300\ \Omega$, $C_L = 35\text{ pF}$; $V_{S1} = V_{S2} = 2\text{ V}$; Test Circuit 5 $V_S = 0\text{ V}$, $R_S = 0\ \Omega$, $C_L = 10\text{ nF}$; Test Circuit 6 $R_L = 50\ \Omega$, $C_L = 5\text{ pF}$, $f = 1\text{ MHz}$; Test Circuit 7 $R_L = 50\ \Omega$, $C_L = 5\text{ pF}$, $f = 1\text{ MHz}$; Test Circuit 8 $f = 1\text{ MHz}$ $f = 1\text{ MHz}$ $f = 1\text{ MHz}$ |
| POWER REQUIREMENTS V_{DD} I_{DD} | | 4.5/5.5 1 | | 4.5/5.5 1 | V min/max μA typ μA max | $V_{DD} = 5.5\text{ V}$ Digital Inputs = 0 V or 5 V |

NOTES

¹Temperature ranges are as follows: B Versions -40°C to +85°C; T Version -55°C to +125°C.

²Guaranteed by design, not subject to production test.

Specifications subject to change without notice.

ADG511/ADG512/ADG513—SPECIFICATIONS¹

Single Supply ($V_{DD} = 3.3 \text{ V} \pm 10\%$, $V_{SS} = 0 \text{ V}$, $GND = 0 \text{ V}$, unless otherwise noted)

| Parameter | B Version | | Unit | Test Conditions/Comments |
|--|---|-----------------------------------|--|---|
| | 25°C | 0°C to 70°C | | |
| ANALOG SWITCH Analog Signal Range R_{ON} | 200 | 0 V to V_{DD} 500 | V Ω typ Ω max | $V_D = 1.5 \text{ V}$, $I_S = -1 \text{ mA}$; $V_{DD} = 3 \text{ V}$ |
| LEAKAGE CURRENTS Source OFF Leakage I_S (OFF) Drain OFF Leakage I_D (OFF) Channel ON Leakage I_D , I_S (ON) | ± 0.025 ± 0.1 ± 0.025 ± 0.1 ± 0.05 ± 0.2 | ± 2.5 ± 2.5 ± 5 | nA typ nA max nA typ nA max nA typ nA max | $V_{DD} = 3.6 \text{ V}$ $V_D = 2.6/1 \text{ V}$, $V_S = 1/2.6 \text{ V}$; Test Circuit 2 $V_D = 2.6/1 \text{ V}$, $V_S = 1/2.6 \text{ V}$; Test Circuit 2 $V_D = V_S = 2.6 \text{ V}/1 \text{ V}$; Test Circuit 3 |
| DIGITAL INPUTS Input High Voltage, V_{INH} Input Low Voltage, V_{INL} Input Current I_{INL} or I_{INH} | 0.005 | 2.4 0.8 ± 0.1 | V min V max μA typ μA max | $V_{IN} = V_{INL}$ or V_{INH} |
| DYNAMIC CHARACTERISTICS² t_{ON} t_{OFF} Break-Before-Make Time Delay, t_D (ADG513 Only) Charge Injection OFF Isolation Channel-to-Channel Crosstalk C_S (OFF) C_D (OFF) C_D , C_S (ON) | 600 100 500 11 68 85 9 9 35 | 1200 160 | ns typ ns max ns typ ns max ns typ pC typ dB typ dB typ pF typ pF typ pF typ | $R_L = 300 \Omega$, $C_L = 35 \text{ pF}$; $V_S = 1 \text{ V}$; Test Circuit 4 $R_L = 300 \Omega$, $C_L = 35 \text{ pF}$; $V_S = 1 \text{ V}$; Test Circuit 4 $R_L = 300 \Omega$, $C_L = 35 \text{ pF}$; $V_{S1} = V_{S2} = 1 \text{ V}$; Test Circuit 5 $V_S = 0 \text{ V}$, $R_S = 0 \Omega$, $C_L = 10 \text{ nF}$; Test Circuit 6 $R_L = 50 \Omega$, $C_L = 5 \text{ pF}$, $f = 1 \text{ MHz}$; Test Circuit 7 $R_L = 50 \Omega$, $C_L = 5 \text{ pF}$, $f = 1 \text{ MHz}$; Test Circuit 8 $f = 1 \text{ MHz}$ $f = 1 \text{ MHz}$ $f = 1 \text{ MHz}$ |
| POWER REQUIREMENTS V_{DD} I_{DD} | 0.0001 | 3/3.6 1 | V min/max μA typ μA max | $V_{DD} = 3.6 \text{ V}$ Digital Inputs = 0 V or 3 V |

NOTES

¹Temperature range is as follows: B Version -40°C to $+85^\circ\text{C}$.

²Guaranteed by design, not subject to production test.

Specifications subject to change without notice.

ADG511/ADG512/ADG513

ABSOLUTE MAXIMUM RATINGS¹

(T_A = +25°C unless otherwise noted)

| | |
|--|--|
| V _{DD} to V _{SS} | 44 V |
| V _{DD} to GND | -0.3 V to +25 V |
| V _{SS} to GND | +0.3 V to -25 V |
| Analog, Digital Inputs ² | V _{SS} - 2 V to V _{DD} + 2 V or 30 mA, Whichever Occurs First |
| Continuous Current, S or D | 30 mA |
| Peak Current, S or D | 100 mA (Pulsed at 1 ms, 10% Duty Cycle max) |
| Operating Temperature Range | |
| Industrial (B Version) | -40°C to +85°C |
| Extended (T Version) | -55°C to +125°C |
| Storage Temperature Range | -65°C to +150°C |
| Junction Temperature | 150°C |
| Cerdip Package, Power Dissipation | 900 mW |
| θ _{JA} Thermal Impedance | 76°C/W |
| Lead Temperature, Soldering (10 sec) | 300°C |

| | |
|--|---------|
| Plastic Package, Power Dissipation | 470 mW |
| θ _{JA} Thermal Impedance | 117°C/W |
| Lead Temperature, Soldering (10 sec) | 260°C |
| SOIC Package, Power Dissipation | 600 mW |
| θ _{JA} Thermal Impedance | 77°C/W |
| Lead Temperature, Soldering | |
| Vapor Phase (60 sec) | 215°C |
| Infrared (15 sec) | 220°C |

NOTES

¹Stresses above those listed under Absolute Maximum Ratings may cause permanent damage to the device. This is a stress rating only; functional operation of the device at these or any other conditions above those listed in the operational sections of this specification is not implied. Exposure to absolute maximum rating conditions for extended periods may affect device reliability. Only one absolute maximum rating may be applied at any one time.

²Overvoltages at IN, S or D will be clamped by internal diodes. Current should be limited to the maximum ratings given.

CAUTION

ESD (electrostatic discharge) sensitive device. Electrostatic charges as high as 4000 V readily accumulate on the human body and test equipment and can discharge without detection. Although the ADG511/ADG512/ADG513 features proprietary ESD protection circuitry, permanent damage may occur on devices subjected to high-energy electrostatic discharges. Therefore, proper ESD precautions are recommended to avoid performance degradation or loss of functionality.



ORDERING GUIDE

| Model ¹ | Temperature Range ² | Package Option ³ |
|------------------------|--------------------------------|-----------------------------|
| ADG511BN | -40°C to +85°C | N-16 |
| ADG511BR | -40°C to +85°C | R-16A |
| ADG511ABR ⁴ | -40°C to +85°C | R-16A |
| ADG511TQ ⁴ | -55°C to +125°C | Q-16 |
| ADG512BN | -40°C to +85°C | N-16 |
| ADG512BR | -40°C to +85°C | R-16A |
| ADG512ABR ⁴ | -40°C to +85°C | R-16A |
| ADG513BN | -40°C to +85°C | N-16 |
| ADG513BR | -40°C to +85°C | R-16A |
| ADG513ABR ⁴ | -40°C to +85°C | R-16A |

NOTES

¹For availability of MIL-STD-883, Class B processed parts, contact factory.

²3.3 V specifications apply over 0°C to 70°C temperature range.

³N = Plastic DIP; R = 0.15" Small Outline IC (SOIC); Q = Cerdip.

⁴Trench isolated latch-up proof parts. See Trench Isolation section.

ADG511/ADG512/ADG513

PIN CONFIGURATION (DIP/SOIC)

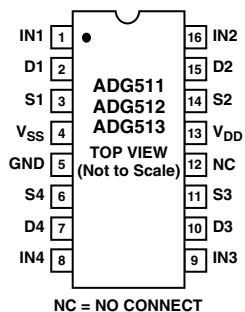

Truth Table (ADG511/ADG512)

| ADG511 In | ADG512 In | Switch Condition |
|--------------|--------------|---------------------|
| 0 | 1 | ON |
| 1 | 0 | OFF |

Truth Table (ADG513)

| Logic | Switch 1, 4 | Switch 2, 3 |
|-------|----------------|----------------|
| 0 | OFF | ON |
| 1 | ON | OFF |

TERMINOLOGY

| | |
|------------------|---|
| V_{DD} | Most Positive Power Supply Potential. |
| V_{SS} | Most Negative Power Supply Potential in dual supplies. In single supply applications, it may be connected to GND. |
| GND | Ground (0 V) Reference. |
| S | Source Terminal. May be an input or output. |
| D | Drain Terminal. May be an input or output. |
| IN | Logic Control Input. |
| R_{ON} | Ohmic Resistance between D and S. |
| I_S (OFF) | Source Leakage Current with the switch "OFF." |
| I_D (OFF) | Drain Leakage Current with the switch "OFF." |
| I_D, I_S (ON) | Channel Leakage Current with the switch "ON." |
| V_D (V_S) | Analog Voltage on terminals D, S. |
| C_S (OFF) | "OFF" Switch Source Capacitance. |
| C_D (OFF) | "OFF" Switch Drain Capacitance. |
| C_D, C_S (ON) | "ON" Switch Capacitance. |
| t_{ON} | Delay between applying the digital control input and the output switching on. |
| t_{OFF} | Delay between applying the digital control input and the output switching off. |
| t_D | "OFF" or "ON" time measured between the 90% points of both switches when switching from one address state to another. |
| Crosstalk | A measure of unwanted signal which is coupled through from one channel to another as a result of parasitic capacitance. |
| Off Isolation | A measure of unwanted signal coupling through an "OFF" switch. |
| Charge Injection | A measure of the glitch impulse transferred from the digital input to the analog output during switching. |

Typical Performance Characteristics—ADG511/ADG512/ADG513

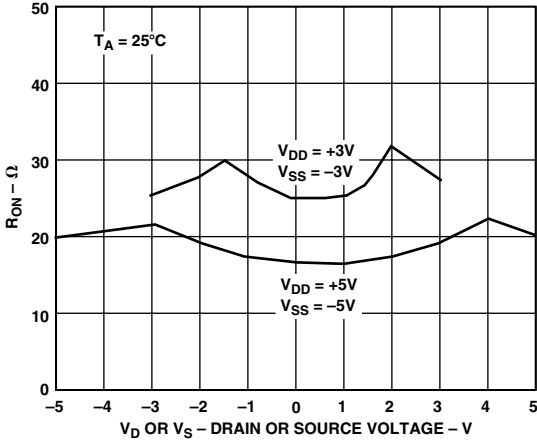

TPC 1. On Resistance as a Function of V_D (V_S) Dual Supplies

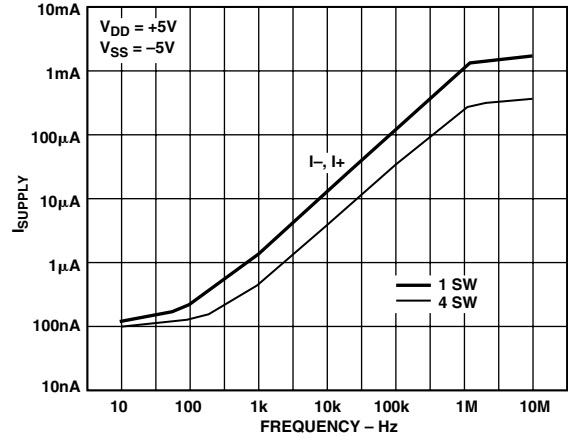

TPC 4. Supply Current vs. Input Switching Frequency



TPC 2. On Resistance as a Function of V_D (V_S) for Different Temperatures

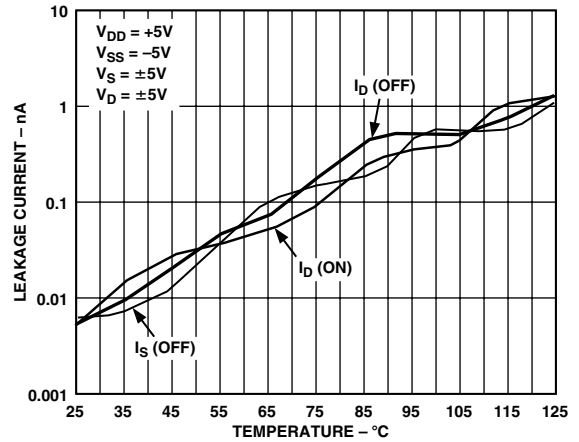

TPC 5. Leakage Currents as a Function of Temperature



TPC 3. On Resistance as a Function of V_D (V_S) Single Supply

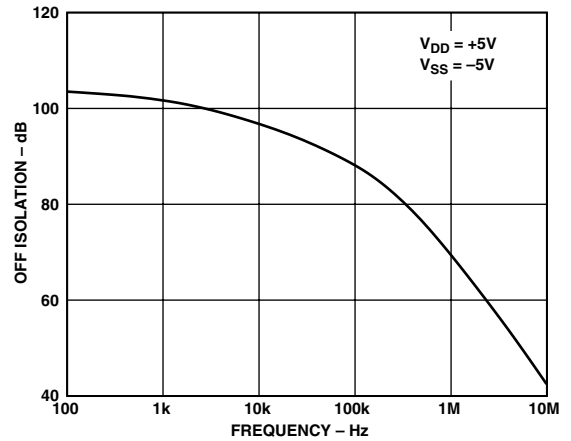

TPC 6. Off Isolation vs. Frequency

ADG511/ADG512/ADG513

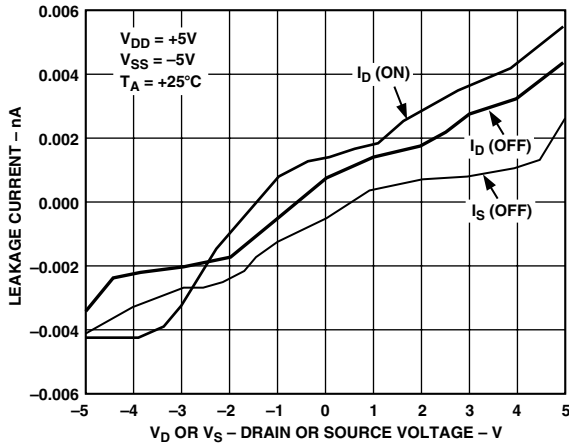

TPC 7. Leakage Currents as a Function of V_D (V_S)



TPC 8. Crosstalk vs. Frequency

APPLICATION

Figure 1 illustrates a precise sample-and-hold circuit. An AD845 is used as the input buffer while the output operational amplifier is an OP07. During the track mode, SW1 is closed and the output V_{OUT} follows the input signal V_{IN} . In the hold mode, SW1 is opened and the signal is held by the hold capacitor C_H .

Due to switch and capacitor leakage, the voltage on the hold capacitor will decrease with time. The ADG511/ADG512/ADG513 minimizes this droop due to its low leakage specifications. The droop rate is further minimized by the use of a poly-styrene hold capacitor. The droop rate for the circuit shown is typically $15 \mu\text{V}/\mu\text{s}$.

A second switch, SW2, which operates in parallel with SW1, is included in this circuit to reduce pedestal error. Since both switches will be at the same potential, they will have a differential effect on the op amp OP07, which will minimize charge injection effects. Pedestal error is also reduced by the compensation

network R_C and C_C . This compensation network also reduces the hold time glitch while optimizing the acquisition time. Using the illustrated op amps and component values, the pedestal error has a maximum value of 5 mV over the $\pm 3 \text{ V}$ input range. The acquisition time is $2.5 \mu\text{s}$ while the settling time is $1.85 \mu\text{s}$.

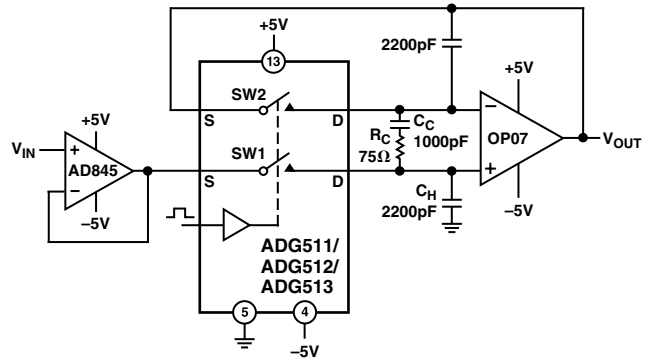

Figure 1. Accurate Sample-and-Hold

TRENCH ISOLATION

The MOS devices that make up the ADG511A/ADG512A/ADG513A are isolated from each other by an oxide layer (trench) (see Figure 2). When the NMOS and PMOS devices are not electrically isolated from each other, there exists the possibility of “latch-up” caused by parasitic junctions between CMOS transistors. Latch-up is caused when P-N junctions that are normally reverse biased, become forward biased, causing large currents to flow. This can be destructive.

CMOS devices are normally isolated from each other by *Junction Isolation*. In Junction Isolation the N and P wells of the CMOS transistors form a diode that is reverse biased under normal operation. However, during overvoltage conditions, this diode becomes forward biased. A Silicon-Controlled Rectifier (SCR)-type circuit is formed by the two transistors, causing a significant amplification of the current that, in turn, leads to latch-up. With Trench Isolation, this diode is removed; the result is a latch-up-proof circuit.

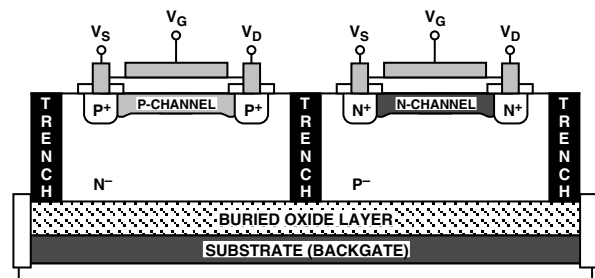

Figure 2. Trench Isolation

Test Circuits



Test Circuit 1. On Resistance



Test Circuit 2. Off Leakage

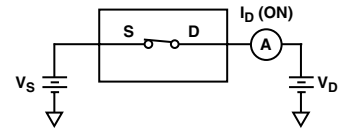

Test Circuit 3. On Leakage



Test Circuit 4. Switching Times

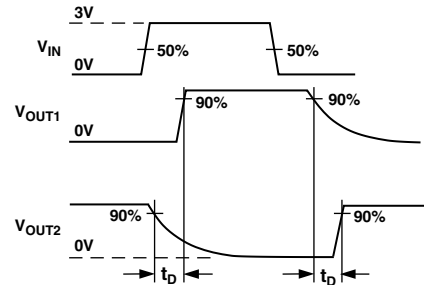

Test Circuit 5. Break-Before-Make Time Delay

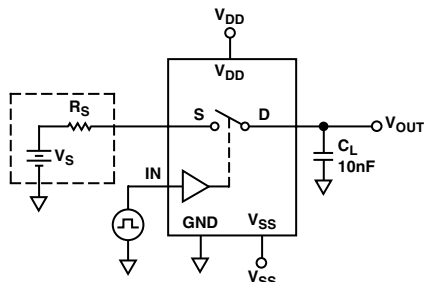

Test Circuit 6. Charge Injection

ADG511/ADG512/ADG513



Test Circuit 7. Off Isolation

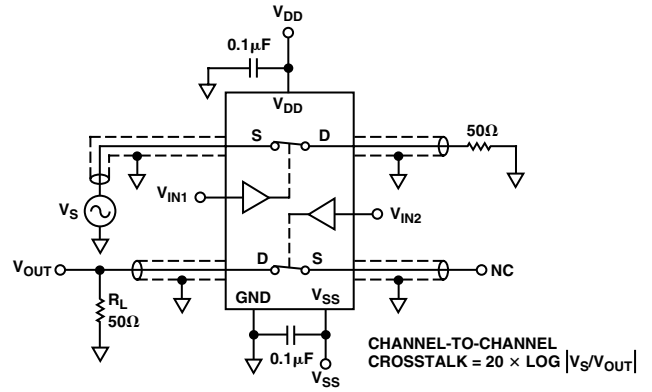

Test Circuit 8. Channel-to-Channel Crosstalk

OUTLINE DIMENSIONS

Dimensions shown in inches and (mm).

16-Lead Plastic DIP (N-16)

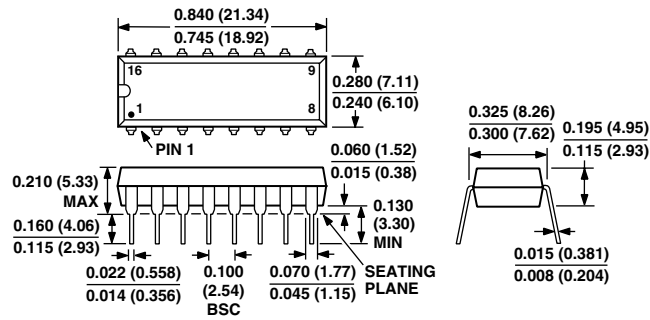

16-Lead Cerdip (Q-16)

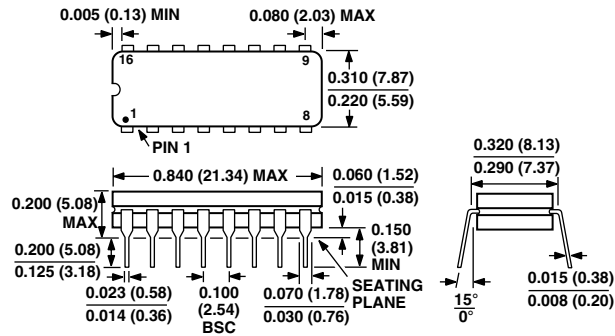

16-Lead SOIC (R-16A)

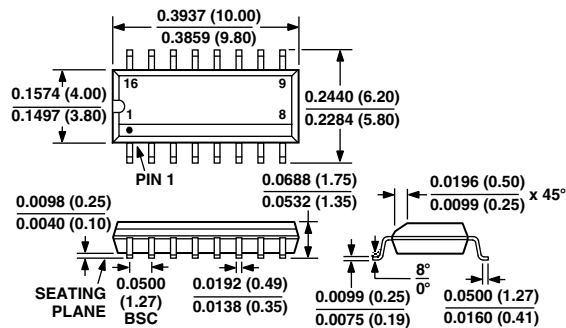

ADG511/ADG512/ADG513—Revision History

| Location | Page |
|---|------|
| Data Sheet changed from REV. B to REV. C. | |
| Changes to Specifications table, Dual Supply, and Notes: “T Versions” made singular | 2 |
| Changes to Specifications table, Single Supply, and Notes: “T Versions” made singular | 3 |
| Change to Ordering Guide: Removed one line | 5 |

C00036b-0-5/01(C)

PRINTED IN U.S.A.

Компания «Life Electronics» занимается поставками электронных компонентов импортного и отечественного производства от производителей и со складов крупных дистрибьюторов Европы, Америки и Азии.

С конца 2013 года компания активно расширяет линейку поставок компонентов по направлению коаксиальный кабель, кварцевые генераторы и конденсаторы (керамические, пленочные, электролитические), за счёт заключения дистрибьюторских договоров

Мы предлагаем:

- Конкурентоспособные цены и скидки постоянным клиентам.
- Специальные условия для постоянных клиентов.
- Подбор аналогов.
- Поставку компонентов в любых объемах, удовлетворяющих вашим потребностям.
- Приемлемые сроки поставки, возможна ускоренная поставка.
- Доставку товара в любую точку России и стран СНГ.
- Комплексную поставку.
- Работу по проектам и поставку образцов.
- Формирование склада под заказчика.
- Сертификаты соответствия на поставляемую продукцию (по желанию клиента).
- Тестирование поставляемой продукции.
- Поставку компонентов, требующих военную и космическую приемку.
- Входной контроль качества.
- Наличие сертификата ISO.

В составе нашей компании организован Конструкторский отдел, призванный помогать разработчикам, и инженерам.

Конструкторский отдел помогает осуществить:

- Регистрацию проекта у производителя компонентов.
- Техническую поддержку проекта.
- Защиту от снятия компонента с производства.
- Оценку стоимости проекта по компонентам.
- Изготовление тестовой платы монтаж и пусконаладочные работы.



Тел: +7 (812) 336 43 04 (многоканальный)

Email: org@lifeelectronics.ru