

High-Efficiency, 40V Step-Up WLED Bias Supplies

FEATURES

- High-Efficiency DC/DC WLED Bias Supply
- Internal 40V, 0.55Ω Power MOSFET
- Up to 10 WLEDs per String
- Two Peak Current Options:
 - ACT6357: 0.5A
 - ACT6358: 1A
- Supports Analog and PWM LED Dimming
- Integrated Over-Voltage Protection (OVP)
- Programmable Soft-Start Function
- Thermal Shutdown
- Cycle-by-Cycle Over Current Protection
- Tiny TDFN33-8 Package

GENERAL DESCRIPTION

The ACT6357 and ACT6358 step-up DC/DC converters drive white LEDs with an externally programmable constant current. These devices feature integrated, 40V power MOSFETs that are capable of driving up to ten white LEDs in series, providing inherent current matching for uniform brightness. WLED brightness adjustment is easily achieved via a dual-function pin, which accepts either a PWM or an analog dimming control signal.

The ACT6357 and ACT6358 feature a variety of protection circuits, including integrated over voltage protection (OVP), programmable soft-start, cycle-by-cycle current limiting, and thermal shutdown protection circuitry.

The ACT6357 has 500mA current limit, while the ACT6358 has 1A current limit. Both parts are available in a small 3mm x 3mm 8-pin TDFN33-8.

APPLICATIONS

- TFT LCD Displays
- Smart Phones
- Portable Media Players
- GPS/Personal Navigation Devices

SIMPLIFIED APPLICATION CIRCUIT

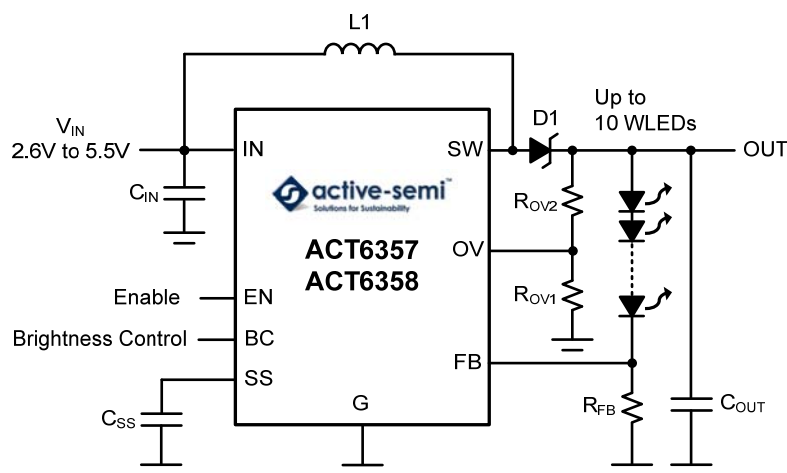

ORDERING INFORMATION

PART NUMBER	CURRENT LIMIT	TEMPERATURE RANGE	PACKAGE	PINS	PACKAGING
ACT6357NH-T	0.5A	-40°C to 85°C	TDFN33-8	8	TAPE & REEL
ACT6358NH-T	1A	-40°C to 85°C	TDFN33-8	8	TAPE & REEL

PIN CONFIGURATION

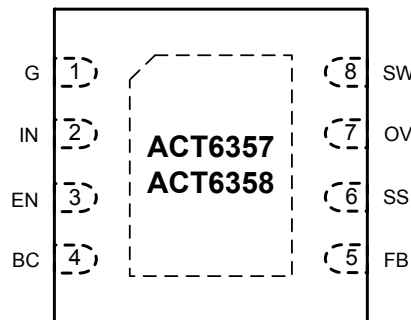

TDFN33-8

PIN DESCRIPTIONS

PIN	NAME	DESCRIPTION
1	G	Ground
2	IN	Supply Input
3	EN	Enable Control. Drive to a logic high to enable the device. Connect to a logic low to disable the device. EN should not be left floating; connect EN to IN when unused.
4	BC	Brightness Control. Multifunction pin accepts either a PWM or analog control signal. When using a PWM control signal, the best results are achieved when the PWM frequency is in the 100Hz to 10kHz range and when the PWM high voltage is 1.8V or higher. When using an analog control signal, the best results are achieved when the control voltage is in the 0V to 1.8V range.
5	FB	Feedback Input. Connect this pin to the cathode of the bottom LED, and a current feedback resistor between this pin and G to set the LED bias current.
6	SS	Soft Start Control Input. Connect a capacitor from this pin to G to program the soft start duration. SS is internally discharged when IC the is disabled.
7	OV	Over Voltage Protection Input. The IC is automatically disabled when the voltage at this pin exceeds 1.21V. Connect OV to the center point of a resistive voltage divider connected across the LED string.
8	SW	Switch Output. Connect this pin to the inductor and the Schottky diode.
EP	EP	Exposed Pad. Connect to ground.

ABSOLUTE MAXIMUM RATINGS^①

PARAMETER	VALUE	UNIT
SW to G	-0.3 to 42	V
IN, EN to G	-0.3 to 6	V
FB, OV, BC, SS to G	-0.3 to $V_{IN} + 0.3$	V
Continuous SW Current	Internally Limited	
Junction to Ambient Thermal Resistance (θ_{JA})	42.5	°C/W
Maximum Power Dissipation	1.9	W
Operating Junction Temperature	-40 to 150	°C
Storage Temperature	-55 to 150	°C
Lead Temperature (Soldering, 10 sec)	300	°C

①: Do not exceed these limits to prevent damage to the device. Exposure to absolute maximum rating conditions for long periods may affect device reliability.

ELECTRICAL CHARACTERISTICS

($V_{IN} = V_{EN} = 3.3V$, $T_A = 25^\circ C$, unless otherwise specified.)

PARAMETER	TEST CONDITIONS	MIN	TYP	MAX	UNIT
Power Switch Voltage Rating				40	V
Input Voltage		2.6		5.5	V
Under Voltage Lockout Threshold	V_{IN} Rising	2.1	2.25	2.45	V
Under Voltage Lockout Hysteresis			80		mV
Supply Current	Not Switching		0.1	0.25	mA
	Switching		0.25	0.5	
Supply Current in Shutdown	EN = G		0.1	10	μA
Maximum On Time	$V_{IN} = 3.3V$	2.6	4.0	5.8	μs
Maximum On Time Constant (K)	$K = t_{MAXON} \times V_{IN}$		13.2		$\mu s \times V$
Minimum Off Time		220	320	450	ns
FB Feedback Voltage	$V_{BC} = 3.3V$	275	290	305	mV
	$V_{BC} = 1.25V$	197	207	217	
	$V_{BC} = 0.625V$	98	106	114	
$\Delta V_{FB}/\Delta V_{BC}$ Ratio			0.16		V/V
FB Input Current	$V_{FB} = 1V$		0	200	nA
BC Input Impedance	$V_{BC} = 0$ to $1.25V$		400		k Ω
Switch Current Limit	ACT6357	320	500	750	mA
	ACT6358	620	1000	1500	
Switch On Resistance	$V_{IN} = 3.3V$		0.55	0.9	Ω
Switch Leakage Current	$V_{SW} = 38V$, EN = G			10	μA
Over Voltage Protection Threshold	V_{OV} Rising	1.11	1.21	1.31	V
OV Input Current	$V_{OV} = 1.5V$		0	200	nA
EN Logic High Threshold		1.4			V
EN Logic Low Threshold				0.4	V
EN Input Current	$V_{EN} = 0V$ or $5V$		0	1	μA
Thermal Shutdown Temperature			160		$^\circ C$
Thermal Shutdown Hysteresis			20		$^\circ C$

FUNCTIONAL BLOCK DIAGRAM

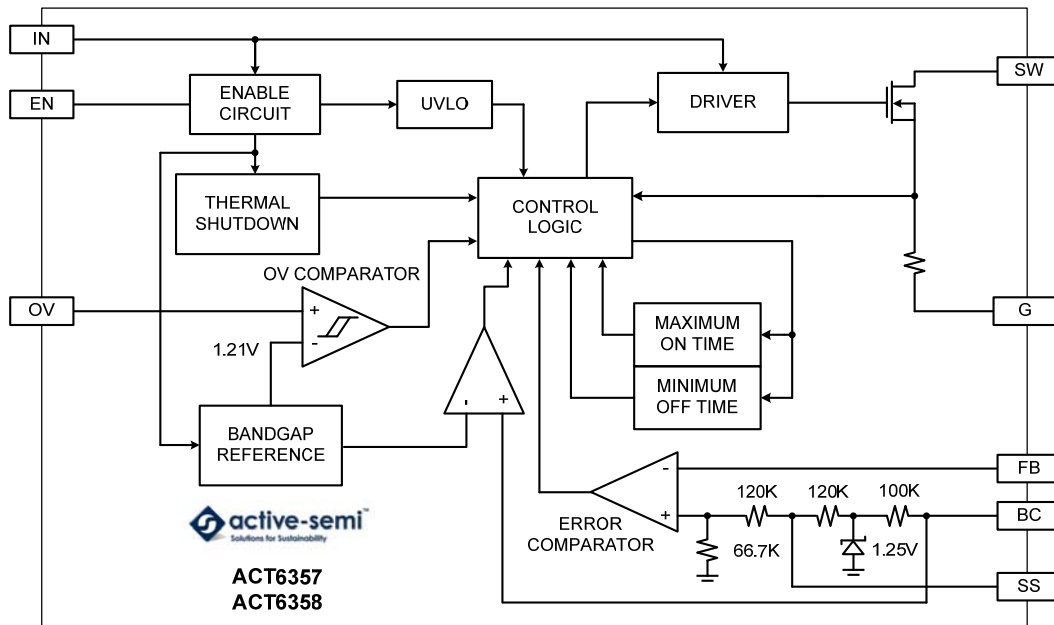

Control Scheme

The ACT6357 and ACT6358 use a minimum off-time, current-mode control scheme to achieve excellent performance under high duty-cycle operating conditions. This control scheme initiates a switching cycle only when needed to maintain output voltage regulation, resulting in very high efficiency operation.

During each switching cycle, the N-channel power MOSFET turns on, increasing the inductor current. The switching cycle terminates when either the inductor current reaches the current limit (500mA for the ACT6357, 1A for the ACT6358) or when the cycle lasts longer than the maximum on-time of 4µs. Once the MOSFET turns off, it remains off for at least the minimum off-time of 320ns, then another switching begins when the error comparator detects that the output is falling out of regulation again.

Soft-Start

The ACT6357 and ACT6358 include a programmable soft-start function, which can be used to optimize an application between start-up time and start-up inrush current. Soft start is achieved by connecting a capacitor C_{SS} between the SS pin and G. The soft start duration can be calculated from the following equation:

$$C_{SS} = t_{SS} \times \frac{5\mu F}{s}$$

where t_{SS} is the required soft start duration. In a typical application, use 0.1µF to generate 20ms soft start time.

Over Voltage Protection

Both the ACT6357 and ACT6358 include internal over-voltage protection circuitry that monitors the OV pin voltage. Over-voltage protection is critical when one of the LEDs in the LED string fails as an open circuit. When this happens the feedback voltage drops to zero, and the control switches at maximum on time causing the output voltage to keep rising until it exceeds the maximum voltage rating of the power MOSFET. The ACT6357 and ACT6358's over-voltage protection detects this condition and switching ceases if the voltage at the OV pin reaches 1.21V.

To set the maximum output voltage, connect a resistor divider from the output node to G, with center tap at OV, and select the two resistors with the following equation:

$$R_{OV2} = R_{OV1} \times \left[\left(\frac{V_{OV}}{1.21V} \right) - 1 \right]$$

where V_{OV} is the over voltage detection threshold, R_{OV1} is the resistor between OV and G, and R_{OV2} is the resistor from the output to the OV pin. As a first estimate, the OV threshold can often be set to 4V times the number of LEDs in the string.

Setting the LED Current

The LED current is programmed by appropriate selection of the feedback resistor R_{FB} connected between FB and G. To set the LED current, choose the resistor according to the equation:

$$R_{FB} = \frac{V_{FB}}{I_{LED}}$$

where V_{FB} is the FB feedback voltage (typically 207mV at $V_{BC} = 1.25V$) and I_{LED} is the desired maximum LED current. Once the LED current is selected via R_{FB} , it may be adjusted via the BC pin to provide a simple means of LED dimming. The BC pin supports both analog as well as PWM dimming control.

Analog Dimming Control

To implement analog dimming, apply a voltage between 0.1V to 1.25V to BC. The resulting LED current as a function of V_{BC} is given by:

$$I_{LED} = 0.16 \times \left(\frac{V_{BC}}{R_{FB}} \right)$$

BC may be overdriven, but driving V_{BC} higher than 1.8V produces a constant LED current given by:

$$I_{LED} = \frac{290mV}{R_{FB}}$$

Direct PWM Dimming Control

The ACT6357 and ACT6358 support direct PWM dimming control, allowing LED current to be adjusted via a PWM signal without the need for an external RC network. For PWM dimming, drive BC with a logic-level PWM signal to scale the LED current proportionally with the PWM duty cycle, with resulting LED current given by:

$$I_{LED} = \left(\frac{V_{FB}}{R_{FB}} \right) \times DUTY$$

For best results, use PWM frequencies in the 100Hz to 10kHz range.

Inductor Selection

The ACT6357 and ACT6358 were designed for operation with inductors in the 4.7μH to 47μH range, and achieve best results under most operating conditions when using 22μH to 33μH. Keep in mind that larger-valued inductors generally result in continuous conduction mode operation (CCM) and yield higher efficiency due to lower peak currents, while smaller inductors typically yield a smaller footprint but at the cost of lower efficiency, resulting from higher peak currents (and their associated I^2R losses). For best results, choose an inductor with a

low DC-Resistance (DCR) and be sure to choose an inductor with a saturation current that exceeds the current limit (500mA for the ACT6357 and 1A for the ACT6358).

Capacitor Selection

The ACT6357 and ACT6358 only require a tiny 0.47μF output capacitor for most applications. For circuits driving 6 or fewer LEDs, a 4.7μF input capacitor is generally suitable. For circuits driving more than 6 LEDs, a 10μF input capacitor may be required.

When choosing a larger inductor which results in CCM operation, stability and ripple can be improved by adding a small feed-forward capacitor from OUT to FB. About 3000pF is a good starting point for most applications, although a larger value can be used to achieve best result in applications with 6 or fewer LEDs

Ceramic capacitors are recommended for most applications. For best performance, use X5R and X7R type ceramic capacitors, which possess less degradation in capacitance over voltage and temperature.

Diode Selection

The ACT6357 and ACT6358 require a Schottky diode as the rectifier. Select a low forward voltage drop Schottky diode with forward current (I_F) rating that exceeds the peak current limit (500mA for the ACT6357 and 1A for the ACT6358) and a peak repetitive reverse voltage (V_{RRM}) rating that exceeds the maximum output voltage, typically set by the OV threshold.

Shutdown

The ACT6357 and ACT6358 feature low-current shutdown modes. In shutdown mode, the control circuitry is disabled and the quiescent supply current drops to less than 1μA. To disable the ACT6357 and ACT6358, simply drive EN to a logic low. To enable the ICs, drive EN to a logic high or connect it to the input supply.

Low Input Voltage Applications

In applications that have low input voltage range, such as those powered from 2-3 AA cells, the ACT6357 and ACT6358 may still be used if there is a suitable system supply (such as 3.3V) available to power the controller. In such an application, the inductor may be connected directly to the battery, while the IC power is supplied by the system supply.

TYPICAL PERFORMANCE CHARACTERISTICS

($V_{IN} = 3.6V$, $T_A = 25^\circ C$, unless otherwise specified.)

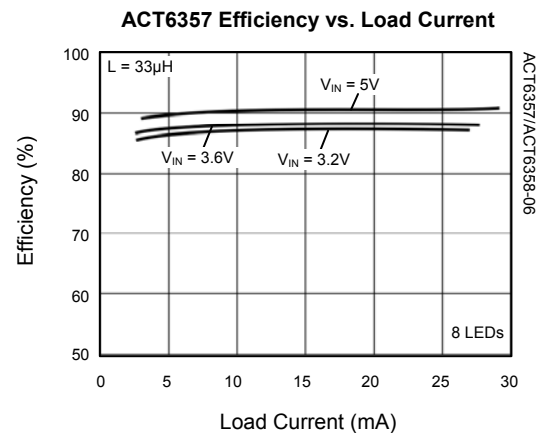
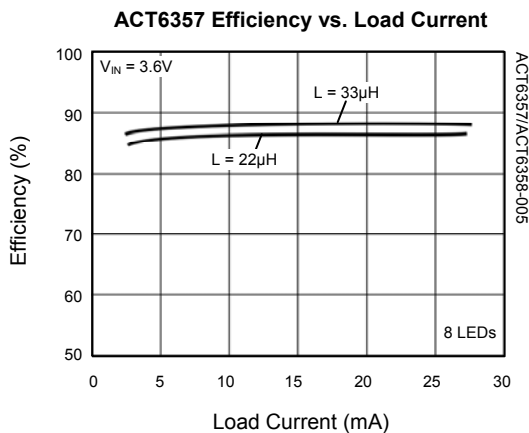
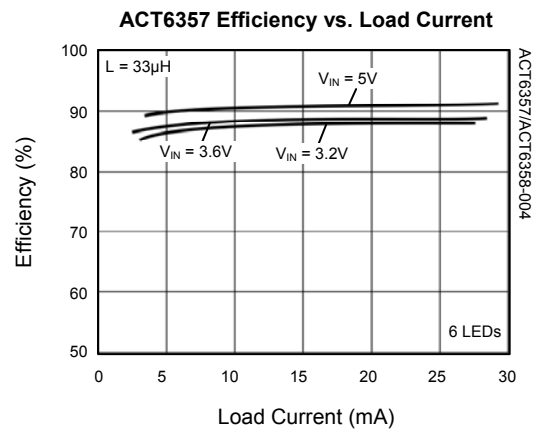
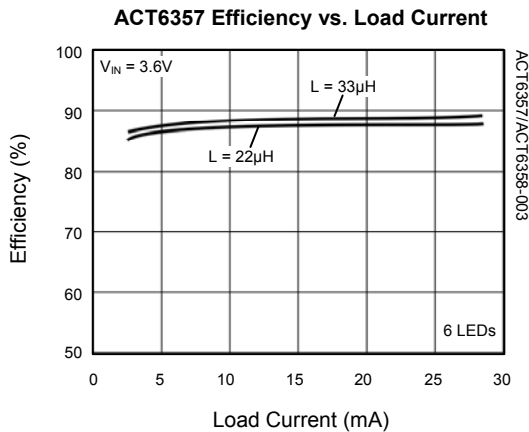
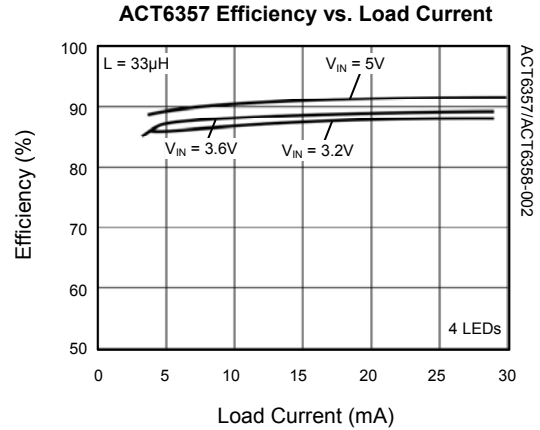
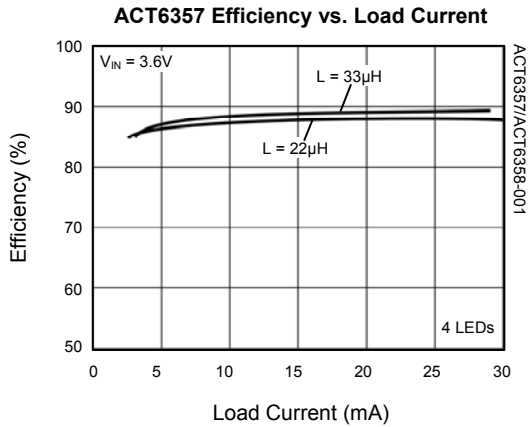

TYPICAL PERFORMANCE CHARACTERISTICS

($V_{IN} = 3.6V$, $T_A = 25^\circ C$, unless otherwise specified.)

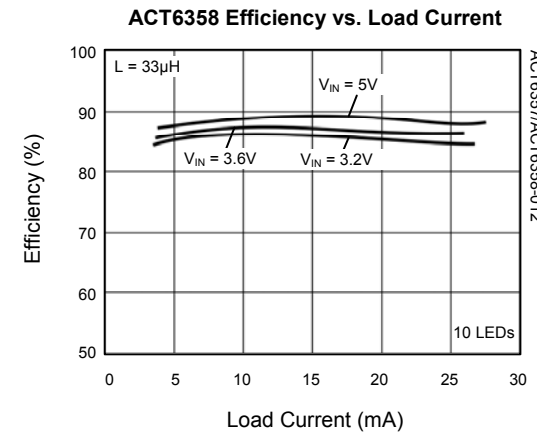
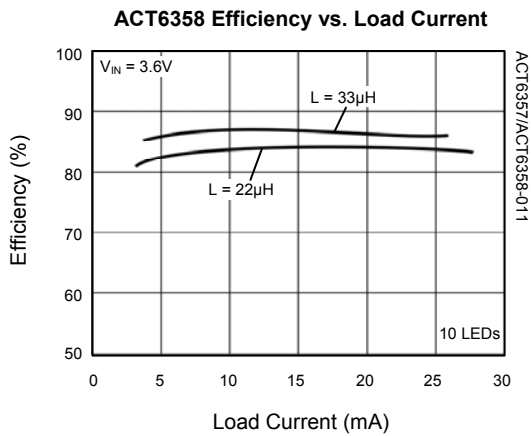
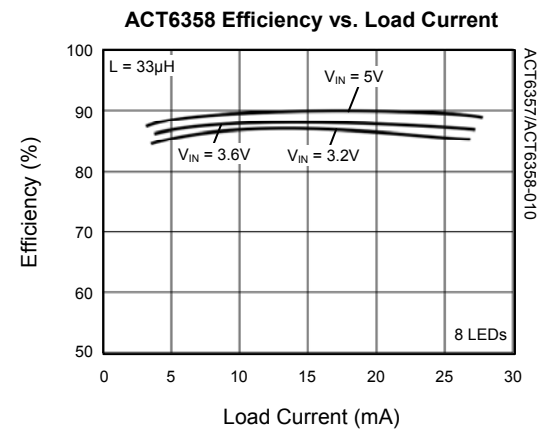
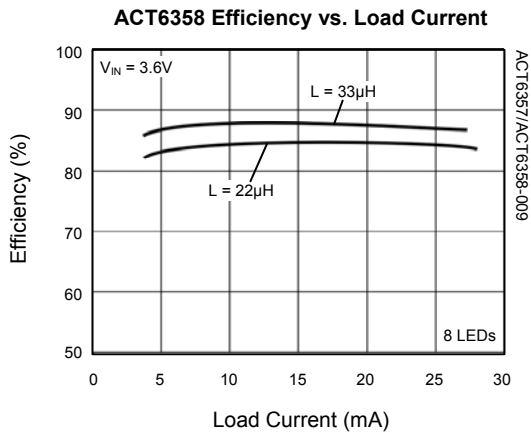
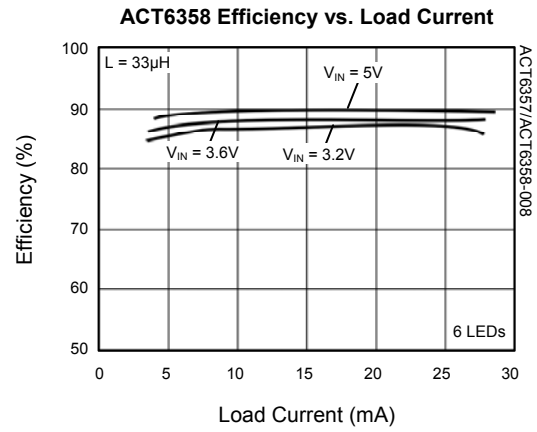
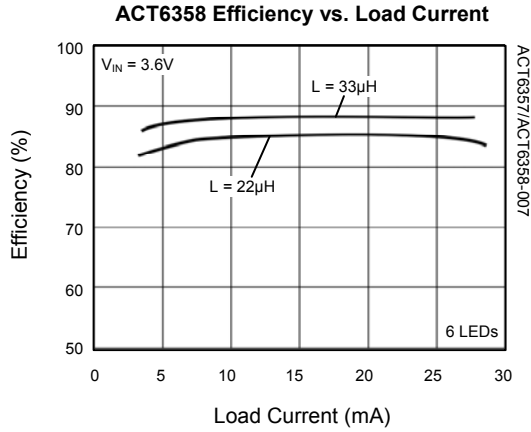

TYPICAL PERFORMANCE CHARACTERISTICS

($V_{VIN} = 3.6V$, $T_A = 25^\circ C$, unless otherwise specified.)

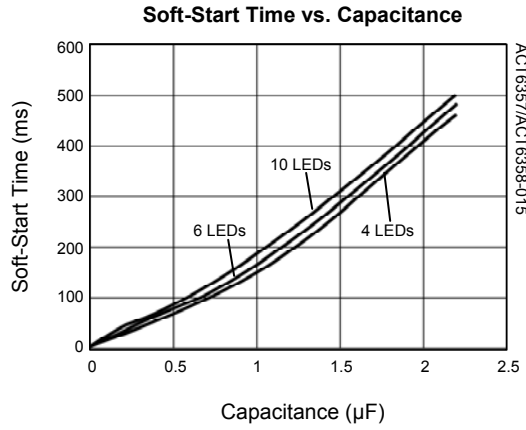
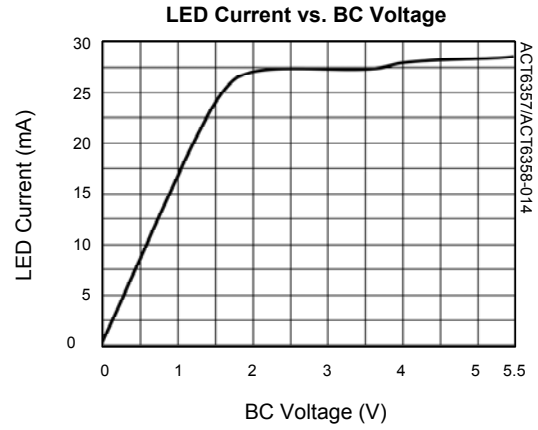
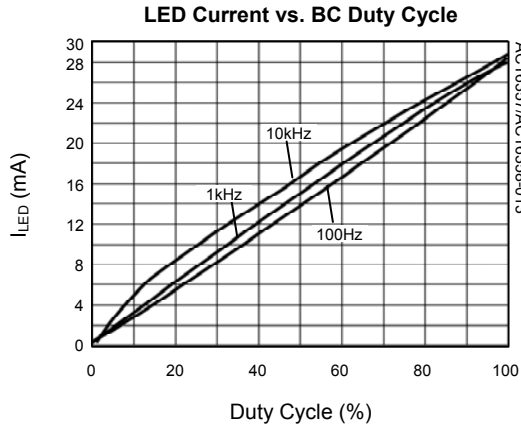

PACKAGE OUTLINE

TDFN33-8 PACKAGE OUTLINE AND DIMENSIONS

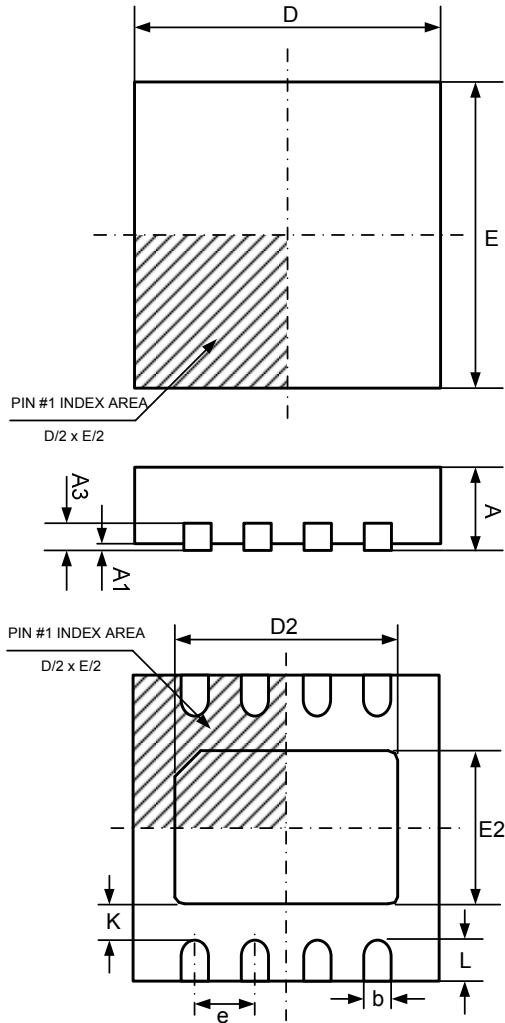

SYMBOL	DIMENSION IN MILLIMETERS		DIMENSION IN INCHES	
	MIN	MAX	MIN	MAX
A	0.700	0.800	0.028	0.031
A1	0.000	0.050	0.000	0.002
A3	0.200 REF		0.008 REF	
D	2.850	3.150	0.112	0.124
E	2.850	3.150	0.112	0.124
D2	2.100	2.500	0.083	0.098
E2	1.350	1.750	0.053	0.069
b	0.250	0.350	0.010	0.014
e	0.650 TYP		0.026 TYP	
L	0.300	0.500	0.012	0.020
K	0.200	---	0.008	---

Active-Semi, Inc. reserves the right to modify the circuitry or specifications without notice. Users should evaluate each product to make sure that it is suitable for their applications. Active-Semi products are not intended or authorized for use as critical components in life-support devices or systems. Active-Semi, Inc. does not assume any liability arising out of the use of any product or circuit described in this datasheet, nor does it convey any patent license.

Active-Semi and its logo are trademarks of Active-Semi, Inc. For more information on this and other products, contact sales@active-semi.com or visit <http://www.active-semi.com>.

 is a registered trademark of Active-Semi.

Компания «Life Electronics» занимается поставками электронных компонентов импортного и отечественного производства от производителей и со складов крупных дистрибьюторов Европы, Америки и Азии.

С конца 2013 года компания активно расширяет линейку поставок компонентов по направлению коаксиальный кабель, кварцевые генераторы и конденсаторы (керамические, пленочные, электролитические), за счёт заключения дистрибьюторских договоров

Мы предлагаем:

- Конкуренспособные цены и скидки постоянным клиентам.
- Специальные условия для постоянных клиентов.
- Подбор аналогов.
- Поставку компонентов в любых объемах, удовлетворяющих вашим потребностям.
- Приемлемые сроки поставки, возможна ускоренная поставка.
- Доставку товара в любую точку России и стран СНГ.
- Комплексную поставку.
- Работу по проектам и поставку образцов.
- Формирование склада под заказчика.
- Сертификаты соответствия на поставляемую продукцию (по желанию клиента).
- Тестирование поставляемой продукции.
- Поставку компонентов, требующих военную и космическую приемку.
- Входной контроль качества.
- Наличие сертификата ISO.

В составе нашей компании организован Конструкторский отдел, призванный помогать разработчикам, и инженерам.

Конструкторский отдел помогает осуществить:

- Регистрацию проекта у производителя компонентов.
- Техническую поддержку проекта.
- Защиту от снятия компонента с производства.
- Оценку стоимости проекта по компонентам.
- Изготовление тестовой платы монтаж и пусконаладочные работы.



Тел: +7 (812) 336 43 04 (многоканальный)

Email: org@lifeelectronics.ru