



TJA1044

High-speed CAN transceiver with Standby mode

Rev. 6 — 24 August 2017

Product data sheet

1. General description

The TJA1044 is part of the Mantis family of high-speed CAN transceivers. It provides an interface between a Controller Area Network (CAN) protocol controller and the physical two-wire CAN bus. The transceiver is designed for high-speed CAN applications in the automotive industry, providing the differential transmit and receive capability to (a microcontroller with) a CAN protocol controller.

The TJA1044 offers a feature set optimized for 12 V automotive applications, with significant improvements over NXP's first- and second-generation CAN transceivers, such as the TJA1040 and TJA1042, and excellent ElectroMagnetic Compatibility (EMC) performance. Additionally, the TJA1044 features:

- Ideal passive behavior to the CAN bus when the supply voltage is off
- A very low-current Standby mode with bus wake-up capability
- Excellent EMC performance at speeds up to 500 kbit/s, even without a common mode choke
- TJA1044GT/3 and TJA1044GTK/3 can be interfaced directly to microcontrollers with supply voltages from 3 V to 5 V

These features make the TJA1044 an excellent choice for all types of HS-CAN networks, in nodes that require a low-power mode with wake-up capability via the CAN bus.

The TJA1044 implements the CAN physical layer as defined in ISO 11898-2:2016 and SAE J2284-1 to SAE J2284-5. The TJA1044T is specified for data rates up to 1 Mbit/s. Additional timing parameters defining loop delay symmetry are specified for the other variants. This implementation enables reliable communication in the CAN FD fast phase at data rates up to 5 Mbit/s.

2. Features and benefits

2.1 General

- Fully ISO 11898-2:2016 and SAE J2284-1 to SAE J2284-5 compliant
- Very low-current Standby mode with host and bus wake-up capability
- Optimized for use in 12 V automotive systems
- EMC performance satisfies 'Hardware Requirements for LIN, CAN and FlexRay Interfaces in Automotive Applications', Version 1.3, May 2012.
- AEC-Q100 qualified
- Dark green product (halogen free and Restriction of Hazardous Substances (RoHS) compliant)



- V_{IO} input on TJA1044x/3 variants allows for direct interfacing with 3 V to 5 V microcontrollers. Variants without a V_{IO} pin can interface with 3.3 V and 5 V-supplied microcontrollers, provided the microcontroller I/Os are 5 V tolerant.
- Both V_{IO} and non- V_{IO} variants are available in SO8 and leadless HVSON8 (3.0 mm × 3.0 mm) packages; HVSON8 with improved Automated Optical Inspection (AOI) capability.

2.2 Predictable and fail-safe behavior

- Functional behavior predictable under all supply conditions
- Transceiver disengages from bus when not powered (zero load)
- Transmit Data (TXD) and bus dominant time-out functions
- Internal biasing of TXD and STB input pins

2.3 Protection

- High ESD handling capability on the bus pins (8 kV IEC and HBM)
- Bus pins protected against transients in automotive environments
- Undervoltage detection on pins V_{CC} and V_{IO}
- Thermally protected

2.4 TJA1044 CAN FD (applicable to all product variants except TJA1044T)

- Timing guaranteed for CAN FD data rates up to 5 Mbit/s
- Improved TXD to RXD propagation delay of 210 ns

3. Quick reference data

Table 1. Quick reference data

Symbol	Parameter	Conditions	Min	Typ	Max	Unit
V _{CC}	supply voltage		4.75	-	5.25	V
I _{CC}	supply current	Standby mode; variants without a V _{IO} pin	-	10	15	μA
		Standby mode; variants with a V _{IO} pin	-	-	5	μA
		Normal mode; bus recessive	2	5	10	mA
		Normal mode; bus dominant	20	45	70	mA
V _{uvd(stb)(VCC)}	standby undervoltage detection voltage on pin V _{CC}		3.5	4	4.3	V
V _{uvd(swoff)(VCC)}	switch-off undervoltage detection voltage on pin V _{CC}	valid for variants without a V _{IO} pin	1.3	2.4	3.4	V
V _{IO}	supply voltage on pin V _{IO}		2.95	-	5.25	V
I _{IO}	supply current on pin V _{IO}	Standby mode	-	10	16.5	μA
		Normal mode; bus recessive	10	80	200	μA
		Normal mode; bus dominant	-	350	1000	μA
V _{uvd(swoff)(VIO)}	switch-off undervoltage detection voltage on pin V _{IO}		2.4	2.6	2.8	V
V _{ESD}	electrostatic discharge voltage	IEC 61000-4-2 at pins CANH and CANL	-8	-	+8	kV
V _{CANH}	voltage on pin CANH	limiting value according to IEC60134	-42	-	+42	V
V _{CANL}	voltage on pin CANL	limiting value according to IEC60134	-42	-	+42	V
T _{vj}	virtual junction temperature		-40	-	+150	°C

4. Ordering information

Table 2. Ordering information

Type number ^[1]	Package		Version
	Name	Description	
TJA1044T TJA1044GT TJA1044GT/3	SO8	plastic small outline package; 8 leads; body width 3.9 mm	SOT96-1
TJA1044GTK TJA1044GTK/3	HVSON8	plastic thermal enhanced very thin small outline package; no leads; 8 terminals; body 3 × 3 × 0.85 mm	SOT782-1

[1] TJA1044GT/3 and TJA1044GTK/3 with V_{IO} pin; all variants other than TJA1044T support CAN FD.

5. Block diagram

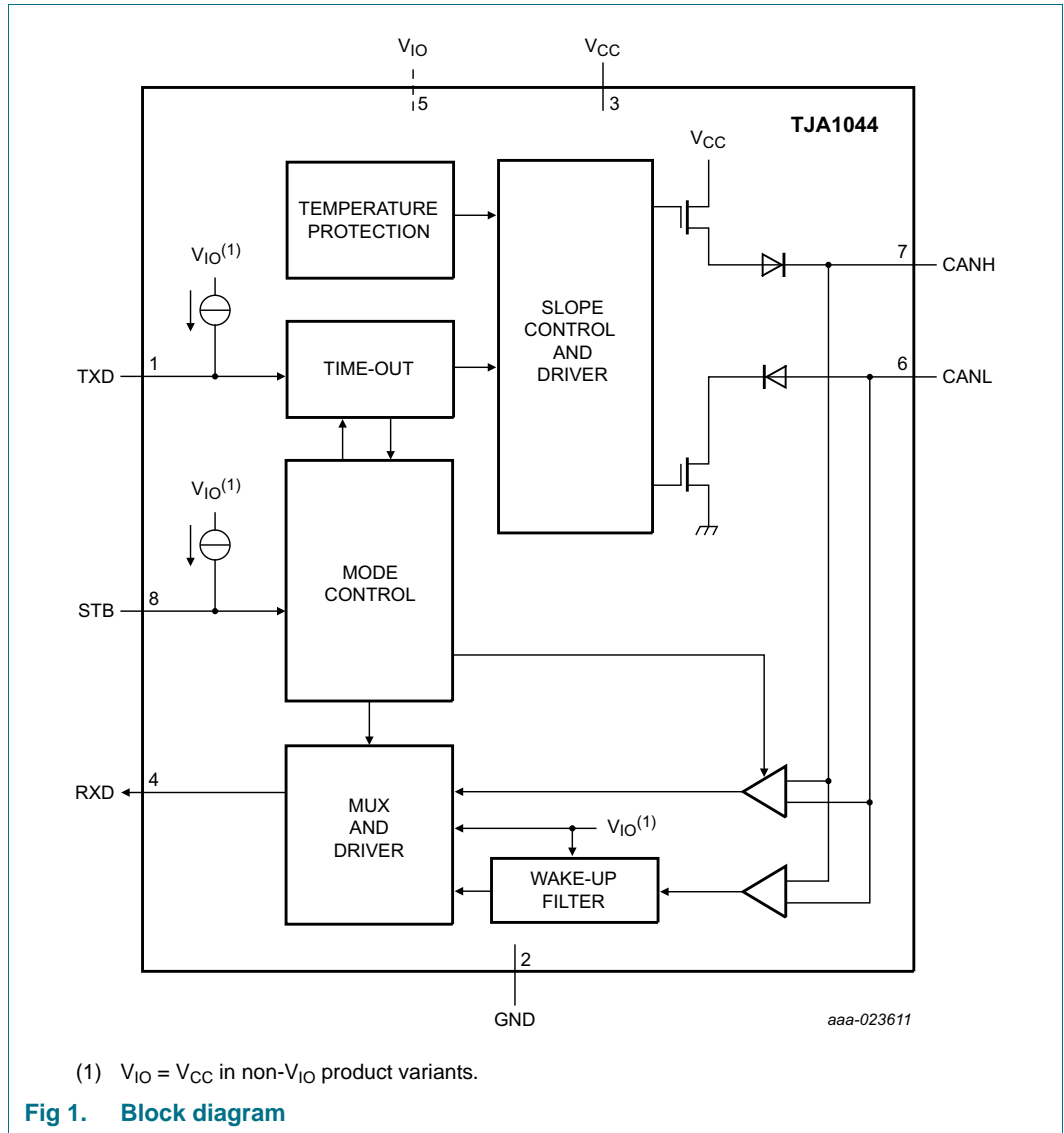

6. Pinning information

6.1 Pinning

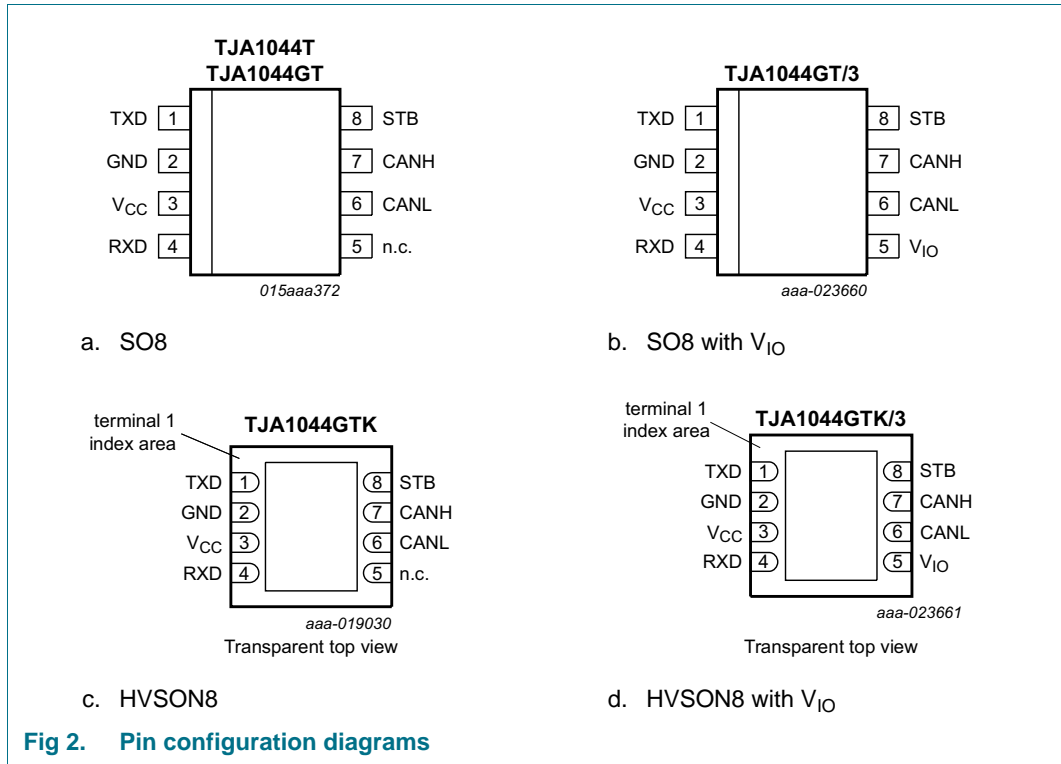

6.2 Pin description

Table 3. Pin description

Symbol	Pin	Description
TXD	1	transmit data input
GND ^[1]	2	ground supply
V _{CC}	3	supply voltage
RXD	4	receive data output; reads out data from the bus lines
n.c.	5	not connected; TJA1044T, TJA1044GT and TJA1044GTK only
V _{IO}	5	supply voltage for I/O level adapter; TJA1044x/3 variants only
CANL	6	LOW-level CAN bus line
CANH	7	HIGH-level CAN bus line
STB	8	Standby mode control input

[1] HVSON8 package die supply ground is connected to both the GND pin and the exposed center pad. The GND pin must be soldered to board ground. For enhanced thermal and electrical performance, it is recommended that the exposed center pad also be soldered to board ground.

7. Functional description

7.1 Operating modes

The TJA1044 supports two operating modes, Normal and Standby. The operating mode is selected via pin STB. See [Table 4](#) for a description of the operating modes under normal supply conditions.

Table 4. Operating modes

Mode	Inputs		Outputs	
	Pin STB	Pin TXD	CAN driver	Pin RXD
Normal	LOW	LOW	dominant	LOW
		HIGH	recessive	LOW when bus dominant HIGH when bus recessive
Standby	HIGH	x ^[1]	biased to ground	follows BUS when wake-up detected HIGH when no wake-up detected

[1] 'x' = don't care.

7.1.1 Normal mode

A LOW level on pin STB selects Normal mode. In this mode, the transceiver can transmit and receive data via the bus lines CANH and CANL (see [Figure 1](#) for the block diagram). The differential receiver converts the analog data on the bus lines into digital data which is output on pin RXD. The slopes of the output signals on the bus lines are controlled internally and are optimized in a way that guarantees the lowest possible EME.

7.1.2 Standby mode

A HIGH level on pin STB selects Standby mode. In Standby mode, the transceiver is not able to transmit or correctly receive data via the bus lines. The transmitter and Normal-mode receiver blocks are switched off to reduce supply current, and only a low-power differential receiver monitors the bus lines for activity.

In Standby mode, the bus lines are biased to ground to minimize system supply current. The low-power receiver is supplied from V_{IO} (V_{CC} in non- V_{IO} variants) and can detect CAN bus activity even if V_{IO} is the only available supply voltage. Pin RXD follows the bus after a wake-up request has been detected. A transition to Normal mode is triggered when STB is forced LOW.

7.2 Remote wake-up (via the CAN bus)

The TJA1044 wakes up from Standby mode when a dedicated wake-up pattern (specified in ISO 11898-2:2016) is detected on the bus. This filtering helps avoid spurious wake-up events. A spurious wake-up sequence could be triggered by, for example, a dominant clamped bus or by dominant phases due to noise or spikes on the bus.

The wake-up pattern consists of:

- a dominant phase of at least $t_{wake(busdom)}$ followed by
- a recessive phase of at least $t_{wake(busrec)}$ followed by
- a dominant phase of at least $t_{wake(busdom)}$

Dominant or recessive bits between the above mentioned phases that are shorter than $t_{wake(busdom)}$ and $t_{wake(busrec)}$ respectively are ignored.

The complete dominant-recessive-dominant pattern must be received within $t_{to(wake)bus}$ to be recognized as a valid wake-up pattern (see Figure 3). Otherwise, the internal wake-up logic is reset. The complete wake-up pattern will then need to be retransmitted to trigger a wake-up event. Pin RXD remains HIGH until the wake-up event has been triggered.

After a wake-up sequence has been detected, the TJA1044 will remain in Standby mode with the bus signals reflected on RXD. Note that dominant or recessive phases lasting less than $t_{fltr(wake)bus}$ will not be detected by the low-power differential receiver and will not be reflected on RXD in Standby mode.

A wake-up event is not flagged on RXD if any of the following events occurs while a valid wake-up pattern is being received:

- The TJA1044 switches to Normal mode
- The complete wake-up pattern was not received within $t_{to(wake)bus}$
- A V_{CC} or V_{IO} undervoltage is detected ($V_{CC} < V_{uvd(swoff)}(V_{CC})$ or $V_{IO} < V_{uvd(swoff)}(V_{IO})$; see Section 7.3.3)



Fig 3. Wake-up timing

7.3 Fail-safe features

7.3.1 TXD dominant time-out function

A 'TXD dominant time-out' timer is started when pin TXD is set LOW. If the LOW state on this pin persists for longer than $t_{to(dom)TXD}$, the transmitter is disabled, releasing the bus lines to recessive state. This function prevents a hardware and/or software application failure from driving the bus lines to a permanent dominant state (blocking all network communications). The TXD dominant time-out timer is reset when pin TXD is set HIGH. The TXD dominant time-out time also defines the minimum possible bit rate of approximately 25 kbit/s.

7.3.2 Internal biasing of TXD and STB input pins

Pins TXD and STB have internal pull-ups to V_{CC} (V_{IO} for variants with a V_{IO} pin) to ensure a safe, defined state in case one or both of these pins are left floating. Pull-up currents flow in these pins in all states; both pins should be held HIGH in Standby mode to minimize supply current.

7.3.3 Undervoltage detection on pins V_{CC} and V_{IO}

If V_{CC} drops below the standby undervoltage detection level, $V_{uvd(stb)(VCC)}$, the transceiver switches to Standby mode. The logic state of pin STB is ignored until V_{CC} has recovered.

In versions with a V_{IO} pin, if V_{IO} drops below the switch-off undervoltage detection level ($V_{uvd(swoff)(VIO)}$), the transceiver switches off and disengages from the bus (zero load) until V_{IO} has recovered.

In versions without a V_{IO} pin, if V_{CC} drops below the switch-off undervoltage detection level ($V_{uvd(swoff)(VCC)}$), the transceiver switches off and disengages from the bus (zero load) until V_{CC} has recovered.

7.3.4 Overtemperature protection

The output drivers are protected against overtemperature conditions. If the virtual junction temperature exceeds the shutdown junction temperature, $T_{j(sd)}$, both output drivers are disabled. When the virtual junction temperature drops below $T_{j(sd)}$ again, the output drivers recover once TXD has been reset to HIGH. Including the TXD condition prevents output driver oscillation due to small variations in temperature.

7.4 V_{IO} supply pin (TJA1044x/3 variants)

Pin V_{IO} should be connected to the microcontroller supply voltage (see [Figure 7](#)). This will adjust the signal levels of pins TXD, RXD and STB to the I/O levels of the microcontroller. Pin V_{IO} also provides the internal supply voltage for the low-power differential receiver in the transceiver. For applications running in low-power mode, this allows the bus lines to be monitored for activity even if there is no supply voltage on pin V_{CC} .

For variants of the TJA1044 without a V_{IO} pin, all circuitry is connected to V_{CC} (pin 5 is not bonded). The signal levels of pins TXD, RXD and STB are then compatible with 5 V microcontrollers. This allows the device to interface with both 3.3 V and 5 V-supplied microcontrollers, provided the microcontroller I/Os are 5 V tolerant.

8. Limiting values

Table 5. Limiting values

In accordance with the Absolute Maximum Rating System (IEC 60134). All voltages are referenced to GND.

Symbol	Parameter	Conditions	Min	Max	Unit
V _x	voltage on pin x ^[1]	on pins CANH, CANL	-42	+42	V
		on pin V _{CC} , V _{IO}	-0.3	+7	V
		on any other pin ^[2]	-0.3	V _{IO} + 0.3 ^[3]	V
V _(CANH-CANL)	voltage between pin CANH and pin CANL		-27	+27	V
V _{trt}	transient voltage	on pins CANH and CANL ^[4]			
		pulse 1	-100	-	V
		pulse 2a	-	75	V
		pulse 3a	-150	-	V
		pulse 3b	-	100	V
V _{ESD}	electrostatic discharge voltage	IEC 61000-4-2 (150 pF, 330 Ω) ^[5]			
		on pins CANH and CANL	-8	+8	kV
		Human Body Model (HBM); 100 pF, 1.5 kΩ ^[6]			
		on pins CANH and CANL	-8	+8	kV
		on any other pin	-4	+4	kV
		Machine Model (MM); 200 pF, 0.75 μH, 10 Ω ^[7]			
		on any pin	-200	+200	V
		Charged Device Model (CDM); field Induced charge; 4 pF ^[8]			
on corner pins	-750	+750	V		
on any other pin	-500	+500	V		
T _{vj}	virtual junction temperature	^[9]	-40	+150	°C
T _{stg}	storage temperature		-55	+150	°C

- [1] The device can sustain voltages up to the specified values over the product lifetime, provided applied voltages (including transients) never exceed these values.
- [2] Maximum voltage should never exceed 7 V.
- [3] V_{CC} + 0.3 in the non-V_{IO} product variants TJA1044T/TJA1044GT/TJA1044GTK.
- [4] According to IEC TS 62228 (2007), Section 4.2.4; parameters for standard pulses defined in ISO7637 part 2: 2004-06.
- [5] According to IEC TS 62228 (2007), Section 4.3; DIN EN 61000-4-2.
- [6] According to AEC-Q100-002.
- [7] According to AEC-Q100-003.
- [8] According to AEC-Q100-011 Rev-C1. The classification level is C4B.
- [9] In accordance with IEC 60747-1. An alternative definition of virtual junction temperature is: $T_{vj} = T_{amb} + P \times R_{th(vj-a)}$, where $R_{th(vj-a)}$ is a fixed value to be used for the calculation of T_{vj}. The rating for T_{vj} limits the allowable combinations of power dissipation (P) and ambient temperature (T_{amb}).

9. Thermal characteristics

Table 6. Thermal characteristics

According to IEC 60747-1.

Symbol	Parameter	Conditions	Value	Unit
R _{th(vj-a)}	thermal resistance from virtual junction to ambient	SO8 package; in free air	97	K/W
		HVSON8 package; in free air		
		dual-layer board	[1] 91	K/W
		four-layer board	[2] 52	K/W

- [1] According to JEDEC JESD51-2, JESD51-3 and JESD51-5 at natural convection on 1s board with thermal via array under the exposed pad connected to the second copper layer.
- [2] According to JEDEC JESD51-2, JESD51-5 and JESD51-7 at natural convection on 2s2p board. Board with two inner copper layers (thickness: 35 μm) and thermal via array under the exposed pad connected to the first inner copper layer.

10. Static characteristics

Table 7. Static characteristics

$T_{vj} = -40\text{ °C to }+150\text{ °C}$; $V_{CC} = 4.75\text{ V to }5.25\text{ V}$; $V_{IO} = 2.95\text{ V to }5.25\text{ V}$ [1]; $R_L = 60\text{ }\Omega$; $C_L = 100\text{ pF}$ unless specified otherwise; All voltages are defined with respect to ground. Positive currents flow into the IC. [2]

Symbol	Parameter	Conditions	Min	Typ	Max	Unit
Supply; pin V_{CC}						
V _{CC}	supply voltage		4.75	-	5.25	V
V _{uvd(stb)(VCC)}	standby undervoltage detection voltage on pin V _{CC}		3.5	4	4.3	V
V _{uvd(swoff)(VCC)}	switch-off undervoltage detection voltage on pin V _{CC}	for variants without a V _{IO} pin	1.3	2.4	3.4	V
I _{CC}	supply current	Standby mode				
		variants without a V _{IO} pin; V _{TXD} = V _{CC}	-	10	15	μA
		variants with a V _{IO} pin; V _{TXD} = V _{IO}	-	-	5	μA
		Normal mode				
		recessive; V _{TXD} = V _{IO} [3]	2	5	10	mA
		dominant; V _{TXD} = 0 V	20	45	70	mA
	dominant; V _{TXD} = 0 V; short circuit on bus lines; -3 V < (V _{CANH} = V _{CANL}) < +18 V	2	80	110	mA	
I/O level adapter supply; pin V_{IO} [1]						
V _{IO}	supply voltage on pin V _{IO}		2.95	-	5.25	V
I _{IO}	supply current on pin V _{IO}	Standby mode; V _{TXD} = V _{IO} [3]	-	10	16.5	μA
		Normal mode				
		recessive; V _{TXD} = V _{IO} [3]	10	80	200	μA
	dominant; V _{TXD} = 0 V	-	350	1000	μA	
V _{uvd(swoff)(VIO)}	switch-off undervoltage detection voltage on pin V _{IO}	for variants with a V _{IO} pin	2.4	2.6	2.8	V

Table 7. Static characteristics ...continued

$T_{vj} = -40\text{ }^{\circ}\text{C}$ to $+150\text{ }^{\circ}\text{C}$; $V_{CC} = 4.75\text{ V}$ to 5.25 V ; $V_{IO} = 2.95\text{ V}$ to 5.25 V [1]; $R_L = 60\ \Omega$; $C_L = 100\text{ pF}$ unless specified otherwise; All voltages are defined with respect to ground. Positive currents flow into the IC. [2]

Symbol	Parameter	Conditions	Min	Typ	Max	Unit	
Standby mode control input; pin STB							
V_{IH}	HIGH-level input voltage	variants with a V_{IO} pin	$0.7V_{IO}$	-	$V_{IO} + 0.3$	V	
		variants without a V_{IO} pin	2	-	$V_{CC} + 0.3$	V	
V_{IL}	LOW-level input voltage	variants with a V_{IO} pin	$-0.3V_{IO}$	-	$+0.3V_{IO}$	V	
		variants without a V_{IO} pin	-0.3	-	+0.8	V	
I_{IH}	HIGH-level input current	$V_{STB} = V_{IO}$ [3]	-1	-	+1	μA	
I_{IL}	LOW-level input current	$V_{STB} = 0\text{ V}$	-15	-	-1	μA	
CAN transmit data input; pin TXD							
V_{IH}	HIGH-level input voltage	variants with a V_{IO} pin	$0.7V_{IO}$	-	$V_{IO} + 0.3$	V	
		variants without a V_{IO} pin	2	-	$V_{CC} + 0.3$	V	
V_{IL}	LOW-level input voltage	variants with a V_{IO} pin	$-0.3V_{IO}$	-	$+0.3V_{IO}$	V	
		variants without a V_{IO} pin	-0.3	-	+0.8	V	
I_{IH}	HIGH-level input current	$V_{TXD} = V_{IO}$ [3]	-5	-	+5	μA	
I_{IL}	LOW-level input current	$V_{TXD} = 0\text{ V}$; variants with a V_{IO} pin	-260	-150	-60	μA	
		$V_{TXD} = 0\text{ V}$; variants without a V_{IO} pin	-260	-150	-70	μA	
C_i	input capacitance	[4]	-	5	10	pF	
CAN receive data output; pin RXD							
I_{OH}	HIGH-level output current	$V_{RXD} = V_{IO}$ [3] - 0.4 V	-8	-3	-1	mA	
I_{OL}	LOW-level output current	$V_{RXD} = 0.4\text{ V}$; bus dominant	1	-	12	mA	
Bus lines; pins CANH and CANL							
$V_{O(\text{dom})}$	dominant output voltage	$V_{TXD} = 0\text{ V}$; $t < t_{\text{to}(\text{dom})\text{TXD}}$					
		pin CANH; $R_L = 50\ \Omega$ to $65\ \Omega$	2.75	3.5	4.5	V	
		pin CANL; $R_L = 50\ \Omega$ to $65\ \Omega$	0.5	1.5	2.25	V	
$V_{\text{dom}(\text{TX})\text{sym}}$	transmitter dominant voltage symmetry	$V_{\text{dom}(\text{TX})\text{sym}} = V_{CC} - V_{\text{CANH}} - V_{\text{CANL}}$	-400	-	+400	mV	
V_{TXsym}	transmitter voltage symmetry	$V_{\text{TXsym}} = V_{\text{CANH}} + V_{\text{CANL}}$; [4] $f_{\text{TXD}} = 250\text{ kHz}$, 1 MHz and 2.5 MHz ; [5] $C_{\text{SPLIT}} = 4.7\text{ nF}$	$0.9V_{CC}$	-	$1.1V_{CC}$	V	
$V_{O(\text{dif})}$	differential output voltage	dominant; Normal mode; $V_{TXD} = 0\text{ V}$; $t < t_{\text{to}(\text{dom})\text{TXD}}$;					
		$R_L = 50\ \Omega$ to $65\ \Omega$	1.5	-	3	V	
		$R_L = 45\ \Omega$ to $70\ \Omega$	1.4	-	3.3	V	
		$R_L = 2240\ \Omega$	1.5	-	5	V	
		recessive					
		Normal mode: $V_{TXD} = V_{IO}$ [3]; no load	-50	-	+50	mV	
$V_{O(\text{rec})}$	recessive output voltage	Normal mode; $V_{TXD} = V_{IO}$ [3]; no load	2	$0.5V_{CC}$	3	V	
		Standby mode; no load	-0.1	-	+0.1	V	

Table 7. Static characteristics ...continued

$T_{vj} = -40\text{ }^{\circ}\text{C}$ to $+150\text{ }^{\circ}\text{C}$; $V_{CC} = 4.75\text{ V}$ to 5.25 V ; $V_{IO} = 2.95\text{ V}$ to 5.25 V [1]; $R_L = 60\text{ }\Omega$; $C_L = 100\text{ pF}$ unless specified otherwise; All voltages are defined with respect to ground. Positive currents flow into the IC. [2]

Symbol	Parameter	Conditions	Min	Typ	Max	Unit
$V_{th(RX)dif}$	differential receiver threshold voltage	$-12\text{ V} \leq V_{CANL} \leq +12\text{ V}$; $-12\text{ V} \leq V_{CANH} \leq +12\text{ V}$				
		Normal mode	0.5	-	0.9	V
		Standby mode	0.4	-	1.15	V
$V_{rec(RX)}$	receiver recessive voltage	$-12\text{ V} \leq V_{CANL} \leq +12\text{ V}$; $-12\text{ V} \leq V_{CANH} \leq +12\text{ V}$				
		Normal mode	-4	-	0.5	V
		Standby mode	-4	-	0.4	V
$V_{dom(RX)}$	receiver dominant voltage	$-12\text{ V} \leq V_{CANL} \leq +12\text{ V}$; $-12\text{ V} \leq V_{CANH} \leq +12\text{ V}$				
		Normal mode	0.9	-	9.0	V
		Standby mode	1.15	-	9.0	V
$V_{hys(RX)dif}$	differential receiver hysteresis voltage	$-12\text{ V} \leq V_{CANL} \leq +12\text{ V}$; $-12\text{ V} \leq V_{CANH} \leq +12\text{ V}$; Normal mode	50	-	300	mV
$I_{O(sc)dom}$	dominant short-circuit output current	$V_{TXD} = 0\text{ V}$; $t < t_{to(dom)TXD}$; $V_{CC} = 5\text{ V}$				
		pin CANH; $V_{CANH} = -15\text{ V}$ to $+40\text{ V}$	-100	-70	-40	mA
		pin CANL; $V_{CANL} = -15\text{ V}$ to $+40\text{ V}$	40	70	100	mA
$I_{O(sc)rec}$	recessive short-circuit output current	Normal mode; $V_{TXD} = V_{IO}$ [3]; $V_{CANH} = V_{CANL} = -27\text{ V}$ to $+32\text{ V}$	-5	-	+5	mA
I_L	leakage current	$V_{CC} = V_{IO} = 0\text{ V}$ or $V_{CC} = V_{IO} = \text{shorted to GND via } 47\text{ k}\Omega$; $V_{CANH} = V_{CANL} = 5\text{ V}$	-5	-	+5	μA
R_i	input resistance	$-2\text{ V} \leq V_{CANL} \leq +7\text{ V}$; $-2\text{ V} \leq V_{CANH} \leq +7\text{ V}$	[4] 9	15	28	k Ω
ΔR_i	input resistance deviation	$0\text{ V} \leq V_{CANL} \leq +5\text{ V}$; $0\text{ V} \leq V_{CANH} \leq +5\text{ V}$	[4] -3	-	+3	%
$R_{i(dif)}$	differential input resistance	$-2\text{ V} \leq V_{CANL} \leq +7\text{ V}$; $-2\text{ V} \leq V_{CANH} \leq +7\text{ V}$	[4] 19	30	52	k Ω
$C_{i(cm)}$	common-mode input capacitance		[4] -	-	20	pF
$C_{i(dif)}$	differential input capacitance		[4] -	-	10	pF
Temperature detection						
$T_{j(sd)}$	shutdown junction temperature		[4] -	185	-	$^{\circ}\text{C}$

[1] Only TJA1044x/3 variants have a V_{IO} pin; all circuitry is connected to V_{CC} in the other variants.

[2] Factory testing uses correlated test conditions to cover the specified temperature and power supply voltage range.

[3] $V_{IO} = V_{CC}$ in non- V_{IO} product variants..

[4] Not tested in production; guaranteed by design.

[5] The test circuit used to measure the bus output voltage symmetry (which includes C_{SPLIT}) is shown in Figure 9.

11. Dynamic characteristics

Table 8. Dynamic characteristics

$T_{vj} = -40\text{ }^{\circ}\text{C}$ to $+150\text{ }^{\circ}\text{C}$; $V_{CC} = 4.75\text{ V}$ to 5.25 V ; $V_{IO} = 2.95\text{ V}$ to 5.25 V [1]; $R_L = 60\text{ }\Omega$; $C_L = 100\text{ pF}$ unless specified otherwise. All voltages are defined with respect to ground. [2]

Symbol	Parameter	Conditions	Min	Typ	Max	Unit
Transceiver timing; pins CANH, CANL, TXD and RXD; see Figure 8 and Figure 4						
$t_{d(\text{TXD-busdom})}$	delay time from TXD to bus dominant	Normal mode	-	65	-	ns
$t_{d(\text{TXD-busrec})}$	delay time from TXD to bus recessive	Normal mode	-	90	-	ns
$t_{d(\text{busdom-RXD})}$	delay time from bus dominant to RXD	Normal mode	-	60	-	ns
$t_{d(\text{busrec-RXD})}$	delay time from bus recessive to RXD	Normal mode	-	65	-	ns
$t_{d(\text{TXDL-RXDL})}$	delay time from TXD LOW to RXD LOW	TJA1044T; Normal mode	50	-	230	ns
		all other variants; Normal mode	50	-	210	ns
$t_{d(\text{TXDH-RXDH})}$	delay time from TXD HIGH to RXD HIGH	TJA1044T; Normal mode	50	-	230	ns
		all other variants; Normal mode	50	-	210	ns
$t_{\text{bit}(\text{bus})}$	transmitted recessive bit width	TJA1044Gx				
		$t_{\text{bit}(\text{TXD})} = 500\text{ ns}$ [3]	435	-	530	ns
		$t_{\text{bit}(\text{TXD})} = 200\text{ ns}$ [3]	155	-	210	ns
$t_{\text{bit}(\text{RXD})}$	bit time on pin RXD	TJA1044Gx				
		$t_{\text{bit}(\text{TXD})} = 500\text{ ns}$ [3]	400	-	550	ns
		$t_{\text{bit}(\text{TXD})} = 200\text{ ns}$ [3]	120	-	220	ns
Δt_{rec}	receiver timing symmetry	TJA1044Gx				
		$t_{\text{bit}(\text{TXD})} = 500\text{ ns}$	-65	-	+40	ns
		$t_{\text{bit}(\text{TXD})} = 200\text{ ns}$	-45	-	+15	ns
$t_{\text{to}(\text{dom})\text{TXD}}$	TXD dominant time-out time	$V_{\text{TXD}} = 0\text{ V}$; Normal mode	0.8	3	6.5	ms
$t_{d(\text{stb-norm})}$	standby to normal mode delay time		7	25	47	μs
$t_{\text{wake}(\text{busdom})}$	bus dominant wake-up time	Standby mode; variants with a V_{IO} pin	0.5	-	1.8	μs
		Standby mode; variants without a V_{IO} pin	0.5	-	3.0	μs
$t_{\text{wake}(\text{busrec})}$	bus recessive wake-up time	Standby mode; variants with a V_{IO} pin	0.5	-	1.8	μs
		Standby mode; variants without a V_{IO} pin	0.5	-	3.0	μs
$t_{\text{to}(\text{wake})\text{bus}}$	bus wake-up time-out time	Standby mode	0.8	3	6.5	ms
$t_{\text{ftr}(\text{wake})\text{bus}}$	bus wake-up filter time	Standby mode				
		variants without a V_{IO} pin	0.5	1	3	μs
		variants with a V_{IO} pin	0.5	-	1.8	μs

[1] Only TJA1044x/3 variants have a V_{IO} pin; all circuitry is connected to V_{CC} in the other variants.

[2] Factory testing uses correlated test conditions to cover the specified temperature and power supply voltage range.

[3] See Figure 5.

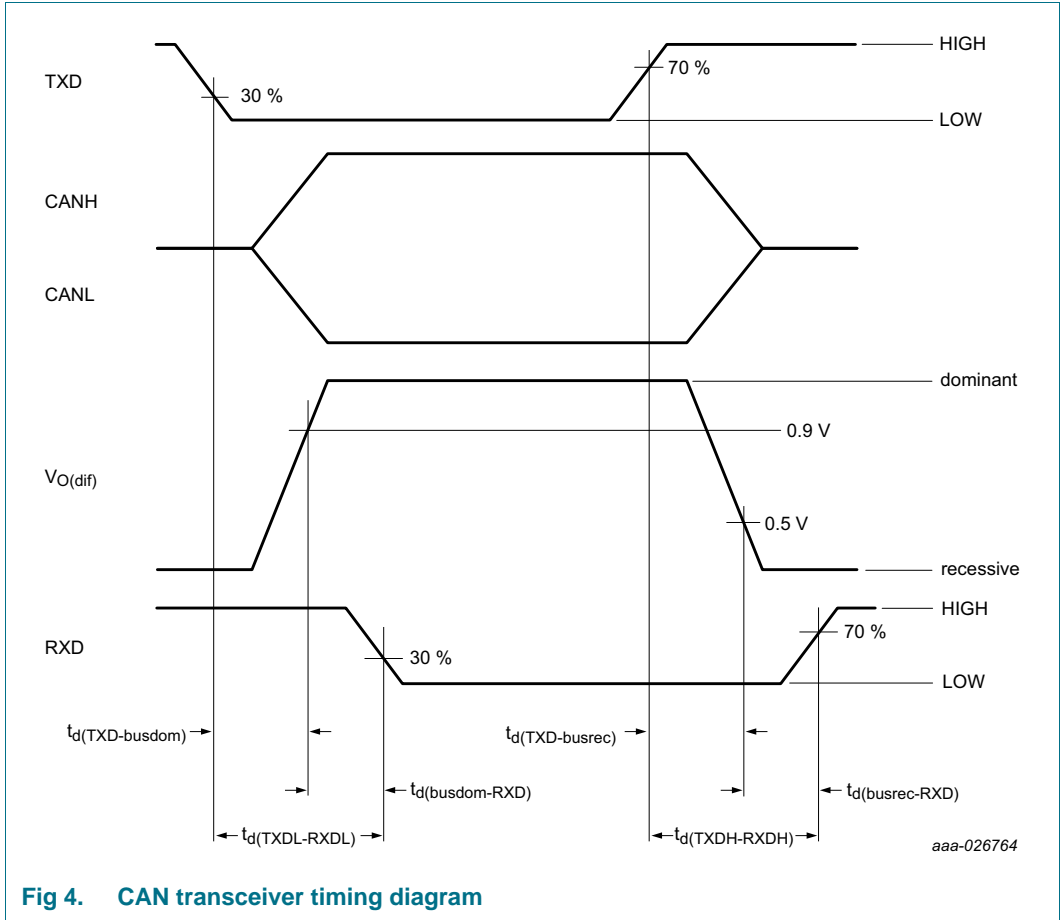

Fig 4. CAN transceiver timing diagram

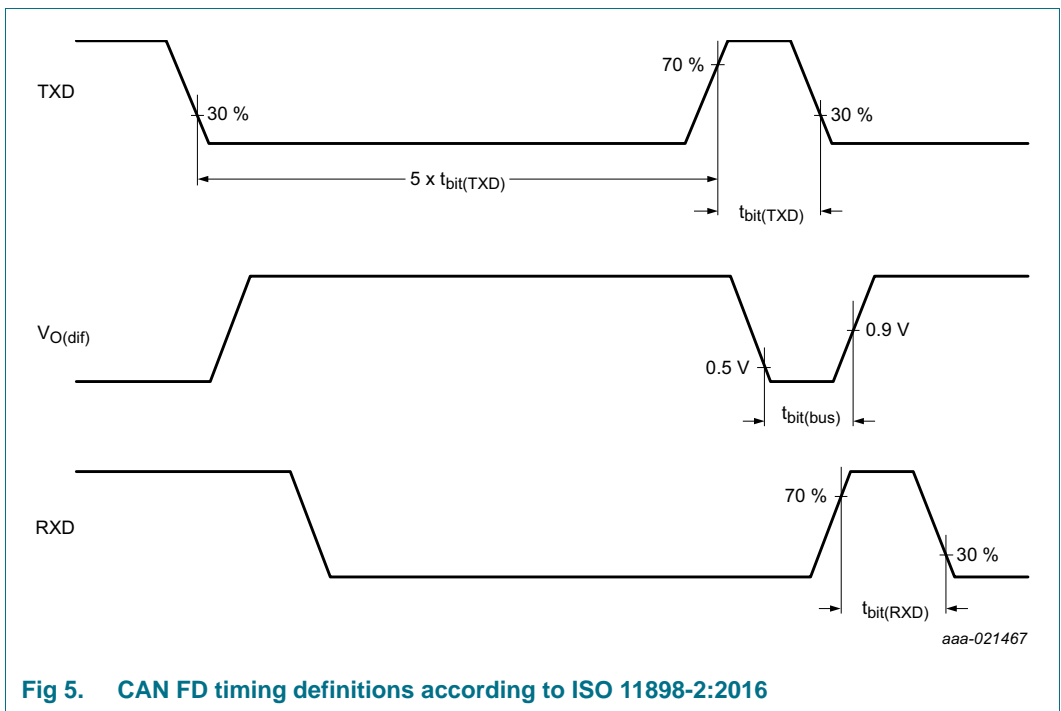
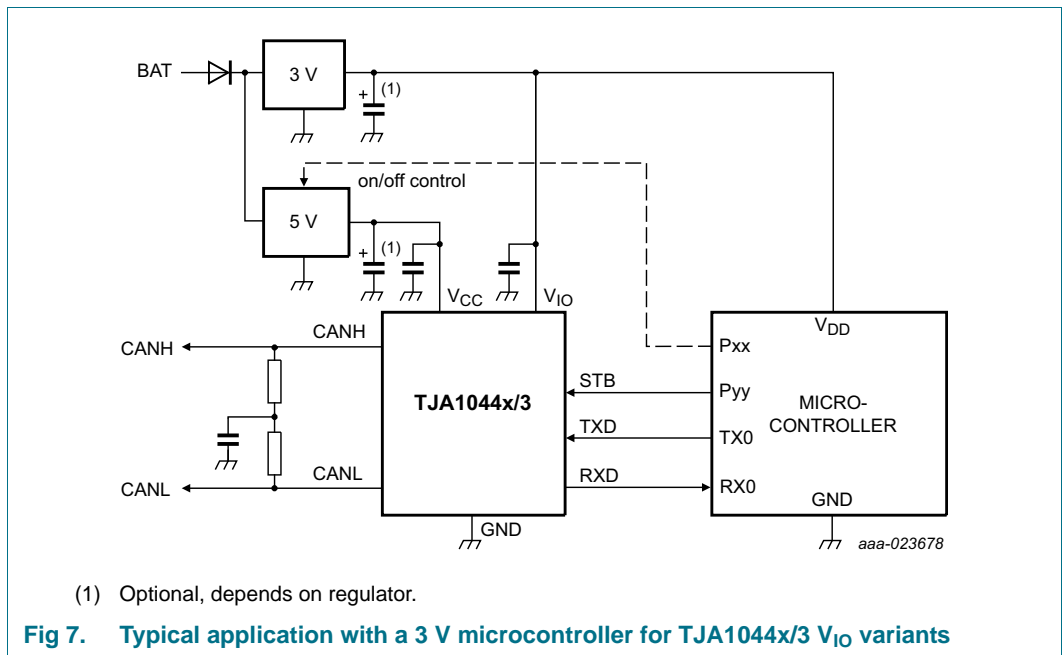
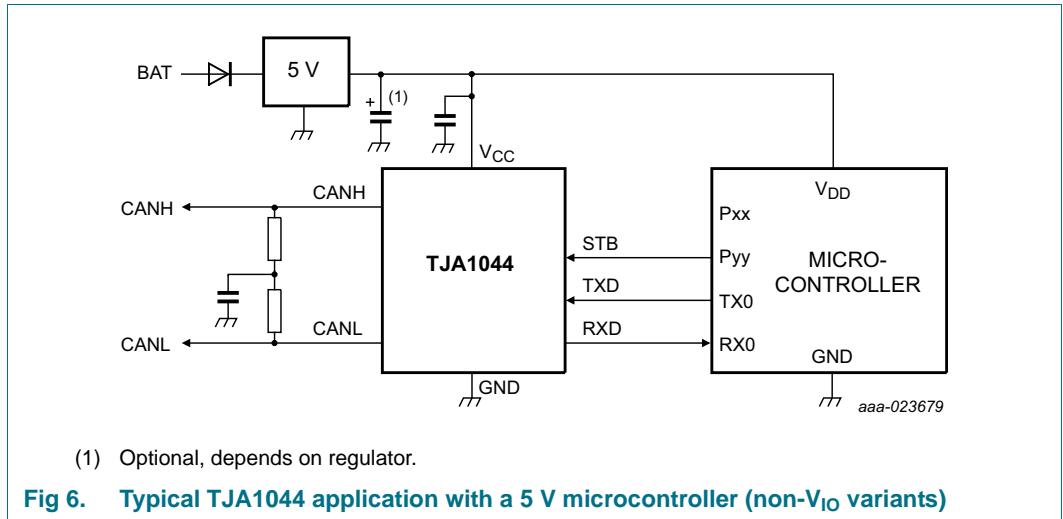

Fig 5. CAN FD timing definitions according to ISO 11898-2:2016

12. Application information

12.1 Application diagram



12.2 Application hints

Further information on the application of the TJA1044 can be found in NXP application hints *AH1308 Application Hints - Standalone high-speed CAN transceivers Mantis TJA1044/TJA1057 and Dual-Mantis TJA1046*.

13. Test information

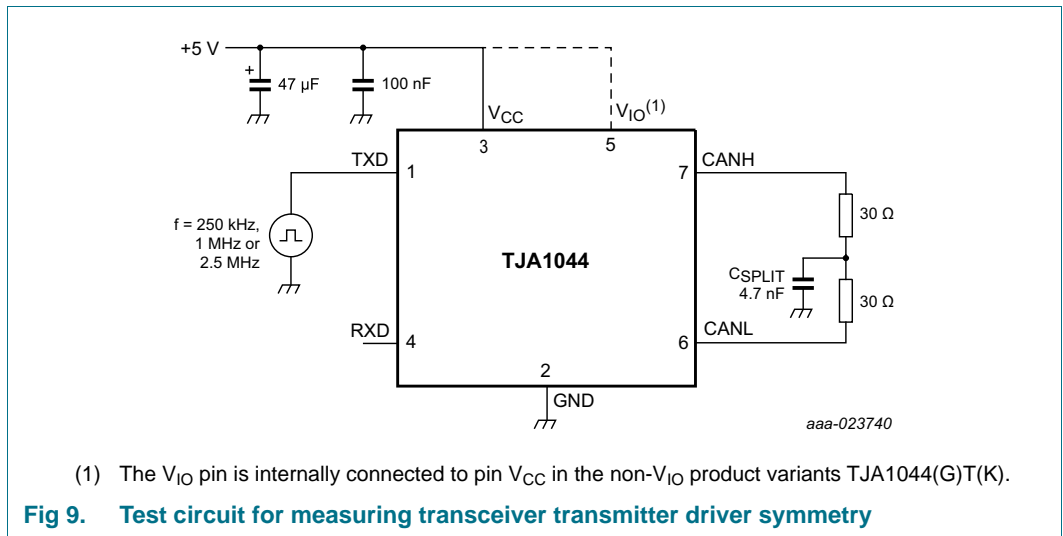
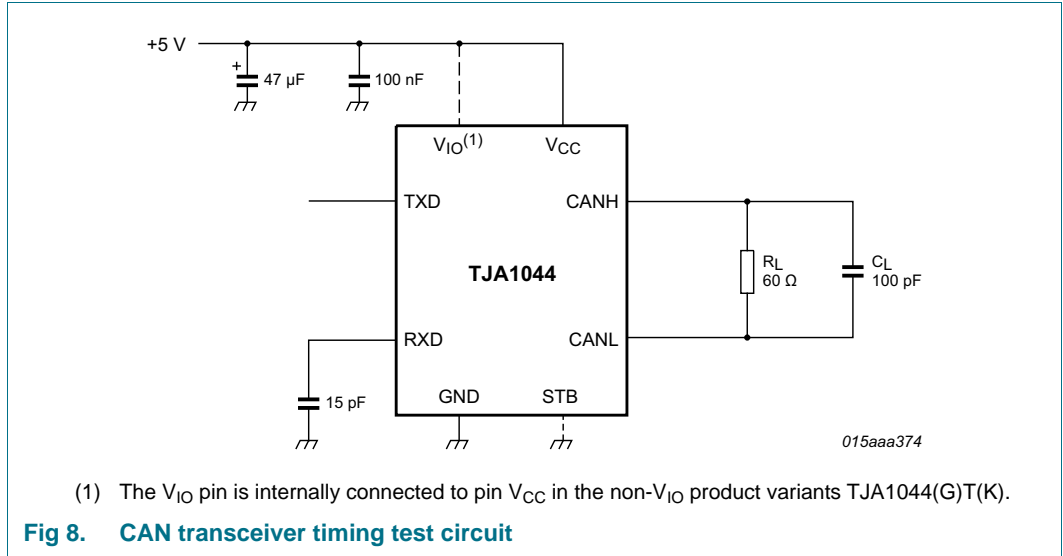

13.1 Quality information

This product has been qualified in accordance with the Automotive Electronics Council (AEC) standard Q100 Rev-G - Failure mechanism based stress test qualification for integrated circuits, and is suitable for use in automotive applications.

14. Package outline

SO8: plastic small outline package; 8 leads; body width 3.9 mm

SOT96-1

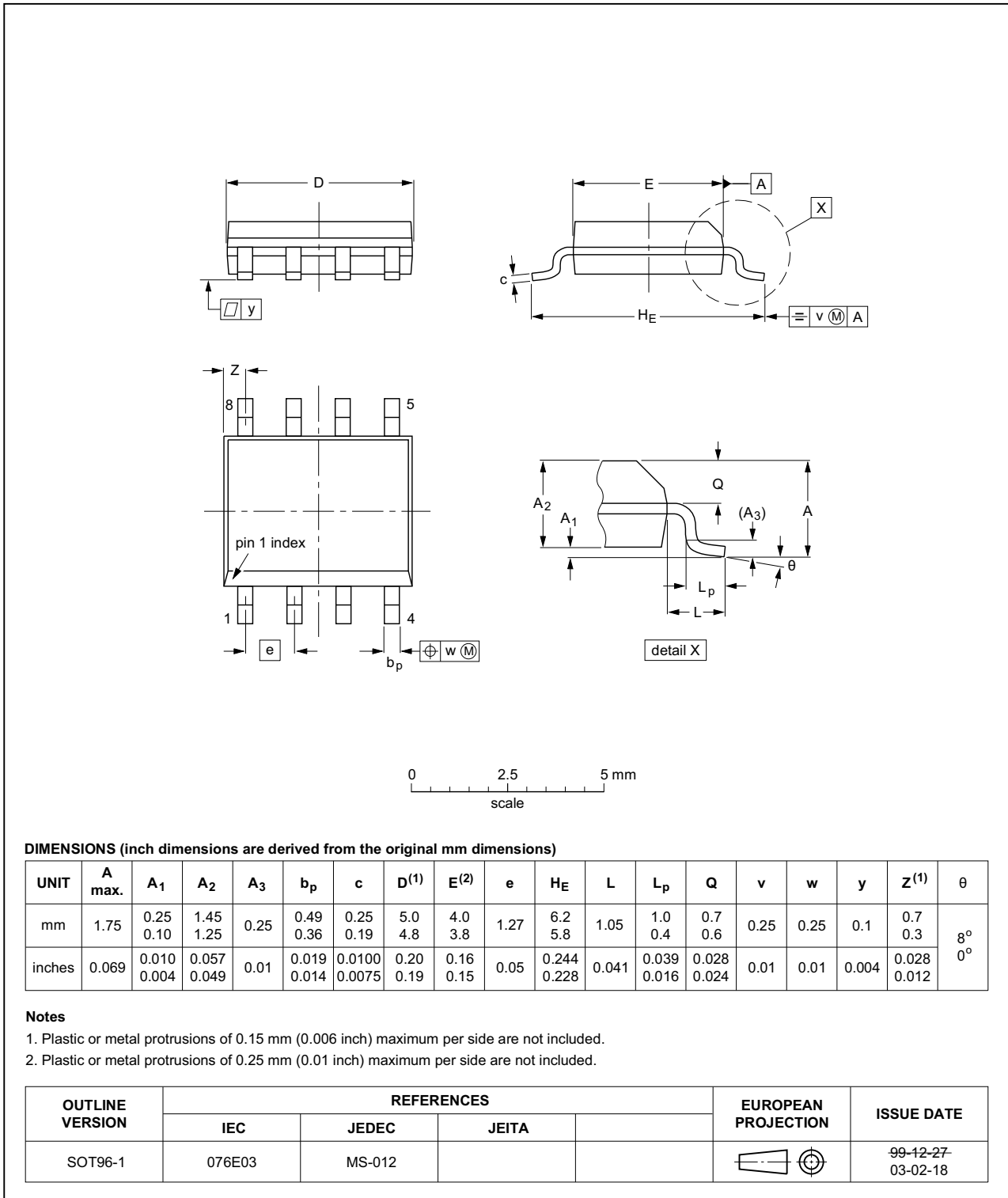

Fig 10. Package outline SOT96-1 (SO8)

HVSON8: plastic thermal enhanced very thin small outline package; no leads;
8 terminals; body 3 x 3 x 0.85 mm

SOT782-1



Fig 11. Package outline SOT782-1 (HVSON8)

15. Handling information

All input and output pins are protected against ElectroStatic Discharge (ESD) under normal handling. When handling ensure that the appropriate precautions are taken as described in *JESD625-A* or equivalent standards.

16. Soldering of SMD packages

This text provides a very brief insight into a complex technology. A more in-depth account of soldering ICs can be found in Application Note *AN10365 "Surface mount reflow soldering description"*.

16.1 Introduction to soldering

Soldering is one of the most common methods through which packages are attached to Printed Circuit Boards (PCBs), to form electrical circuits. The soldered joint provides both the mechanical and the electrical connection. There is no single soldering method that is ideal for all IC packages. Wave soldering is often preferred when through-hole and Surface Mount Devices (SMDs) are mixed on one printed wiring board; however, it is not suitable for fine pitch SMDs. Reflow soldering is ideal for the small pitches and high densities that come with increased miniaturization.

16.2 Wave and reflow soldering

Wave soldering is a joining technology in which the joints are made by solder coming from a standing wave of liquid solder. The wave soldering process is suitable for the following:

- Through-hole components
- Leaded or leadless SMDs, which are glued to the surface of the printed circuit board

Not all SMDs can be wave soldered. Packages with solder balls, and some leadless packages which have solder lands underneath the body, cannot be wave soldered. Also, leaded SMDs with leads having a pitch smaller than ~0.6 mm cannot be wave soldered, due to an increased probability of bridging.

The reflow soldering process involves applying solder paste to a board, followed by component placement and exposure to a temperature profile. Leaded packages, packages with solder balls, and leadless packages are all reflow solderable.

Key characteristics in both wave and reflow soldering are:

- Board specifications, including the board finish, solder masks and vias
- Package footprints, including solder thieves and orientation
- The moisture sensitivity level of the packages
- Package placement
- Inspection and repair
- Lead-free soldering versus SnPb soldering

16.3 Wave soldering

Key characteristics in wave soldering are:

- Process issues, such as application of adhesive and flux, clinching of leads, board transport, the solder wave parameters, and the time during which components are exposed to the wave
- Solder bath specifications, including temperature and impurities

16.4 Reflow soldering

Key characteristics in reflow soldering are:

- Lead-free versus SnPb soldering; note that a lead-free reflow process usually leads to higher minimum peak temperatures (see [Figure 12](#)) than a SnPb process, thus reducing the process window
- Solder paste printing issues including smearing, release, and adjusting the process window for a mix of large and small components on one board
- Reflow temperature profile; this profile includes preheat, reflow (in which the board is heated to the peak temperature) and cooling down. It is imperative that the peak temperature is high enough for the solder to make reliable solder joints (a solder paste characteristic). In addition, the peak temperature must be low enough that the packages and/or boards are not damaged. The peak temperature of the package depends on package thickness and volume and is classified in accordance with [Table 9](#) and [10](#)

Table 9. SnPb eutectic process (from J-STD-020D)

Package thickness (mm)	Package reflow temperature (°C)	
	Volume (mm ³)	
	< 350	≥ 350
< 2.5	235	220
≥ 2.5	220	220

Table 10. Lead-free process (from J-STD-020D)

Package thickness (mm)	Package reflow temperature (°C)		
	Volume (mm ³)		
	< 350	350 to 2000	> 2000
< 1.6	260	260	260
1.6 to 2.5	260	250	245
> 2.5	250	245	245

Moisture sensitivity precautions, as indicated on the packing, must be respected at all times.

Studies have shown that small packages reach higher temperatures during reflow soldering, see [Figure 12](#).



For further information on temperature profiles, refer to Application Note AN10365 “Surface mount reflow soldering description”.

17. Appendix: ISO 11898-2:2016 parameter cross-reference list

Table 11. ISO 11898-2:2016 to NXP data sheet parameter conversion

ISO 11898-2:2016		NXP data sheet	
Parameter	Notation	Symbol	Parameter
HS-PMA dominant output characteristics			
Single ended voltage on CAN_H	V_{CAN_H}	$V_{O(dom)}$	dominant output voltage
Single ended voltage on CAN_L	V_{CAN_L}		
Differential voltage on normal bus load	V_{Diff}	$V_{O(dif)}$	differential output voltage
Differential voltage on effective resistance during arbitration			
Optional: Differential voltage on extended bus load range			
HS-PMA driver symmetry			
Driver symmetry	V_{SYM}	V_{TXsym}	transmitter voltage symmetry
Maximum HS-PMA driver output current			
Absolute current on CAN_H	I_{CAN_H}	$I_{O(sc)dom}$	dominant short-circuit output current
Absolute current on CAN_L	I_{CAN_L}		
HS-PMA recessive output characteristics, bus biasing active/inactive			
Single ended output voltage on CAN_H	V_{CAN_H}	$V_{O(rec)}$	recessive output voltage
Single ended output voltage on CAN_L	V_{CAN_L}		
Differential output voltage	V_{Diff}	$V_{O(dif)}$	differential output voltage
Optional HS-PMA transmit dominant timeout			
Transmit dominant timeout, long	t_{dom}	$t_{to(dom)TXD}$	TXD dominant time-out time
Transmit dominant timeout, short			
HS-PMA static receiver input characteristics, bus biasing active/inactive			
Recessive state differential input voltage range	V_{Diff}	$V_{th(RX)dif}$	differential receiver threshold voltage
Dominant state differential input voltage range		$V_{rec(RX)}$	receiver recessive voltage
		$V_{dom(RX)}$	receiver dominant voltage
HS-PMA receiver input resistance (matching)			
Differential internal resistance	R_{Diff}	$R_{i(dif)}$	differential input resistance
Single ended internal resistance	R_{CAN_H} R_{CAN_L}	R_i	input resistance
Matching of internal resistance	MR	ΔR_i	input resistance deviation
HS-PMA implementation loop delay requirement			
Loop delay	t_{Loop}	$t_{d(TXDH-RXDH)}$	delay time from TXD HIGH to RXD HIGH
		$t_{d(TXDL-RXDL)}$	delay time from TXD LOW to RXD LOW
Optional HS-PMA implementation data signal timing requirements for use with bit rates above 1 Mbit/s up to 2 Mbit/s and above 2 Mbit/s up to 5 Mbit/s			
Transmitted recessive bit width @ 2 Mbit/s / @ 5 Mbit/s, intended	$t_{Bit(Bus)}$	$t_{bit(bus)}$	transmitted recessive bit width
Received recessive bit width @ 2 Mbit/s / @ 5 Mbit/s	$t_{Bit(RXD)}$	$t_{bit(RXD)}$	bit time on pin RXD
Receiver timing symmetry @ 2 Mbit/s / @ 5 Mbit/s	Δt_{Rec}	Δt_{rec}	receiver timing symmetry

Table 11. ISO 11898-2:2016 to NXP data sheet parameter conversion

ISO 11898-2:2016		NXP data sheet	
Parameter	Notation	Symbol	Parameter
HS-PMA maximum ratings of V_{CAN_H}, V_{CAN_L} and V_{Diff}			
Maximum rating V_{Diff}	V_{Diff}	$V_{(CANH-CANL)}$	voltage between pin CANH and pin CANL
General maximum rating V_{CAN_H} and V_{CAN_L}	V_{CAN_H}	V_x	voltage on pin x
Optional: Extended maximum rating V_{CAN_H} and V_{CAN_L}	V_{CAN_L}		
HS-PMA maximum leakage currents on CAN_H and CAN_L, unpowered			
Leakage current on CAN_H, CAN_L	I_{CAN_H} I_{CAN_L}	I_L	leakage current
HS-PMA bus biasing control timings			
CAN activity filter time, long	t_{Filter}	$t_{wake(busdom)}$ ^[1]	bus dominant wake-up time
CAN activity filter time, short		$t_{wake(busrec)}$ ^[1]	bus recessive wake-up time
Wake-up timeout, short	t_{Wake}	$t_{to(wake)bus}$	bus wake-up time-out time
Wake-up timeout, long			
Timeout for bus inactivity	$t_{Silence}$	$t_{to(silence)}$	bus silence time-out time
Bus Bias reaction time	t_{Bias}	$t_{d(busact-bias)}$	delay time from bus active to bias

[1] $t_{filtr(wake)bus}$ - bus wake-up filter time, in devices with basic wake-up functionality

18. Revision history

Table 12. Revision history

Document ID	Release date	Data sheet status	Change notice	Supersedes
TJA1044 v.6.1	20170824	Product data sheet	-	TJA1044 v.5.1
Modifications:	<ul style="list-style-type: none"> • Added variants TJA1044GT/3 and TJA1044GTK/3 with V_{IO} pin that interface directly with 3 V and 5 V microcontrollers. <ul style="list-style-type: none"> – Table 2: added parameters $V_{uvd(swff)}(VCC)$, V_{IO}, I_{IO}, $V_{uvd(swff)}(VIO)$; amended I_{CC} – Amended Figure 8 and Figure 9; added Figure 7 • No changes to product specifications of existing non-V_{IO} variants • Updated to comply with ISO 11898-2:2016 and SAE J22884-1 through SAE J2284-5 specifications: <ul style="list-style-type: none"> – Table 7: conditions added to parameters R_i, ΔR_i and $R_{i(dif)}$; values/conditions changed for parameters I_{CC}, $V_{rec}(RX)$, $V_{dom}(RX)$, $I_{O(sc)dom}$ – Additional measurement taken at $f_{TXD} = 1$ MHz and 2.5 MHz for parameter V_{TXsym}; see Table 7 and Figure 9 – Table 8: values/conditions changed for parameter $t_{filtr(wake)bus}$ – Figure 4: thresholds clarified – Figure 5: title changed • Section 2.1: text of last entry amended • Table 5, Table note 2 added • Amended Figure 4 and Figure 6 • Section 12.2: reference updated 			
TJA1044 v.5.1	20160523	Product data sheet	-	TJA1044 v.4
TJA1044 v.4	20150710	Product data sheet	-	TJA1044 v.3
TJA1044 v.3	20141119	Product data sheet	-	TJA1044 v.2
TJA1044 v.2	20131030	Product data sheet	-	TJA1044 v.1
TJA1044 v.1	20130530	Preliminary data sheet	-	-

19. Legal information

19.1 Data sheet status

Document status ^{[1][2]}	Product status ^[3]	Definition
Objective [short] data sheet	Development	This document contains data from the objective specification for product development.
Preliminary [short] data sheet	Qualification	This document contains data from the preliminary specification.
Product [short] data sheet	Production	This document contains the product specification.

[1] Please consult the most recently issued document before initiating or completing a design.

[2] The term 'short data sheet' is explained in section "Definitions".

[3] The product status of device(s) described in this document may have changed since this document was published and may differ in case of multiple devices. The latest product status information is available on the Internet at URL <http://www.nxp.com>.

19.2 Definitions

Draft — The document is a draft version only. The content is still under internal review and subject to formal approval, which may result in modifications or additions. NXP Semiconductors does not give any representations or warranties as to the accuracy or completeness of information included herein and shall have no liability for the consequences of use of such information.

Short data sheet — A short data sheet is an extract from a full data sheet with the same product type number(s) and title. A short data sheet is intended for quick reference only and should not be relied upon to contain detailed and full information. For detailed and full information see the relevant full data sheet, which is available on request via the local NXP Semiconductors sales office. In case of any inconsistency or conflict with the short data sheet, the full data sheet shall prevail.

Product specification — The information and data provided in a Product data sheet shall define the specification of the product as agreed between NXP Semiconductors and its customer, unless NXP Semiconductors and customer have explicitly agreed otherwise in writing. In no event however, shall an agreement be valid in which the NXP Semiconductors product is deemed to offer functions and qualities beyond those described in the Product data sheet.

19.3 Disclaimers

Limited warranty and liability — Information in this document is believed to be accurate and reliable. However, NXP Semiconductors does not give any representations or warranties, expressed or implied, as to the accuracy or completeness of such information and shall have no liability for the consequences of use of such information. NXP Semiconductors takes no responsibility for the content in this document if provided by an information source outside of NXP Semiconductors.

In no event shall NXP Semiconductors be liable for any indirect, incidental, punitive, special or consequential damages (including - without limitation - lost profits, lost savings, business interruption, costs related to the removal or replacement of any products or rework charges) whether or not such damages are based on tort (including negligence), warranty, breach of contract or any other legal theory.

Notwithstanding any damages that customer might incur for any reason whatsoever, NXP Semiconductors' aggregate and cumulative liability towards customer for the products described herein shall be limited in accordance with the *Terms and conditions of commercial sale* of NXP Semiconductors.

Right to make changes — NXP Semiconductors reserves the right to make changes to information published in this document, including without limitation specifications and product descriptions, at any time and without notice. This document supersedes and replaces all information supplied prior to the publication hereof.

Suitability for use in automotive applications — This NXP Semiconductors product has been qualified for use in automotive applications. Unless otherwise agreed in writing, the product is not designed, authorized or warranted to be suitable for use in life support, life-critical or safety-critical systems or equipment, nor in applications where failure or malfunction of an NXP Semiconductors product can reasonably be expected to result in personal injury, death or severe property or environmental damage. NXP Semiconductors and its suppliers accept no liability for inclusion and/or use of NXP Semiconductors products in such equipment or applications and therefore such inclusion and/or use is at the customer's own risk.

Applications — Applications that are described herein for any of these products are for illustrative purposes only. NXP Semiconductors makes no representation or warranty that such applications will be suitable for the specified use without further testing or modification.

Customers are responsible for the design and operation of their applications and products using NXP Semiconductors products, and NXP Semiconductors accepts no liability for any assistance with applications or customer product design. It is customer's sole responsibility to determine whether the NXP Semiconductors product is suitable and fit for the customer's applications and products planned, as well as for the planned application and use of customer's third party customer(s). Customers should provide appropriate design and operating safeguards to minimize the risks associated with their applications and products.

NXP Semiconductors does not accept any liability related to any default, damage, costs or problem which is based on any weakness or default in the customer's applications or products, or the application or use by customer's third party customer(s). Customer is responsible for doing all necessary testing for the customer's applications and products using NXP Semiconductors products in order to avoid a default of the applications and the products or of the application or use by customer's third party customer(s). NXP does not accept any liability in this respect.

Limiting values — Stress above one or more limiting values (as defined in the Absolute Maximum Ratings System of IEC 60134) will cause permanent damage to the device. Limiting values are stress ratings only and (proper) operation of the device at these or any other conditions above those given in the Recommended operating conditions section (if present) or the Characteristics sections of this document is not warranted. Constant or repeated exposure to limiting values will permanently and irreversibly affect the quality and reliability of the device.

Terms and conditions of commercial sale — NXP Semiconductors products are sold subject to the general terms and conditions of commercial sale, as published at <http://www.nxp.com/profile/terms>, unless otherwise agreed in a valid written individual agreement. In case an individual agreement is concluded only the terms and conditions of the respective agreement shall apply. NXP Semiconductors hereby expressly objects to applying the customer's general terms and conditions with regard to the purchase of NXP Semiconductors products by customer.

No offer to sell or license — Nothing in this document may be interpreted or construed as an offer to sell products that is open for acceptance or the grant, conveyance or implication of any license under any copyrights, patents or other industrial or intellectual property rights.

Export control — This document as well as the item(s) described herein may be subject to export control regulations. Export might require a prior authorization from competent authorities.

Quick reference data — The Quick reference data is an extract of the product data given in the Limiting values and Characteristics sections of this document, and as such is not complete, exhaustive or legally binding.

Translations — A non-English (translated) version of a document is for reference only. The English version shall prevail in case of any discrepancy between the translated and English versions.

19.4 Trademarks

Notice: All referenced brands, product names, service names and trademarks are the property of their respective owners.

Mantis — is a trademark of NXP B.V.

20. Contact information

For more information, please visit: <http://www.nxp.com>

For sales office addresses, please send an email to: salesaddresses@nxp.com

21. Contents

1	General description	1	19.1	Data sheet status	25
2	Features and benefits	1	19.2	Definitions	25
2.1	General	1	19.3	Disclaimers	25
2.2	Predictable and fail-safe behavior	2	19.4	Trademarks	26
2.3	Protection	2	20	Contact information	26
2.4	TJA1044 CAN FD (applicable to all product variants except TJA1044T)	2	21	Contents	27
3	Quick reference data	3			
4	Ordering information	3			
5	Block diagram	4			
6	Pinning information	5			
6.1	Pinning	5			
6.2	Pin description	5			
7	Functional description	6			
7.1	Operating modes	6			
7.1.1	Normal mode	6			
7.1.2	Standby mode	6			
7.2	Remote wake-up (via the CAN bus)	6			
7.3	Fail-safe features	7			
7.3.1	TXD dominant time-out function	7			
7.3.2	Internal biasing of TXD and STB input pins	8			
7.3.3	Undervoltage detection on pins V_{CC} and V_{IO}	8			
7.3.4	Overtemperature protection	8			
7.4	V_{IO} supply pin (TJA1044x/3 variants)	8			
8	Limiting values	9			
9	Thermal characteristics	10			
10	Static characteristics	10			
11	Dynamic characteristics	13			
12	Application information	15			
12.1	Application diagram	15			
12.2	Application hints	15			
13	Test information	16			
13.1	Quality information	16			
14	Package outline	17			
15	Handling information	19			
16	Soldering of SMD packages	19			
16.1	Introduction to soldering	19			
16.2	Wave and reflow soldering	19			
16.3	Wave soldering	19			
16.4	Reflow soldering	20			
17	Appendix: ISO 11898-2:2016 parameter cross-reference list	22			
18	Revision history	24			
19	Legal information	25			

Please be aware that important notices concerning this document and the product(s) described herein, have been included in section 'Legal information'.

© NXP Semiconductors N.V. 2017.

All rights reserved.

For more information, please visit: <http://www.nxp.com>

For sales office addresses, please send an email to: salesaddresses@nxp.com

Date of release: 24 August 2017

Document identifier: TJA1044

Компания «Life Electronics» занимается поставками электронных компонентов импортного и отечественного производства от производителей и со складов крупных дистрибьюторов Европы, Америки и Азии.

С конца 2013 года компания активно расширяет линейку поставок компонентов по направлению коаксиальный кабель, кварцевые генераторы и конденсаторы (керамические, пленочные, электролитические), за счёт заключения дистрибьюторских договоров

Мы предлагаем:

- Конкурентоспособные цены и скидки постоянным клиентам.
- Специальные условия для постоянных клиентов.
- Подбор аналогов.
- Поставку компонентов в любых объемах, удовлетворяющих вашим потребностям.
- Приемлемые сроки поставки, возможна ускоренная поставка.
- Доставку товара в любую точку России и стран СНГ.
- Комплексную поставку.
- Работу по проектам и поставку образцов.
- Формирование склада под заказчика.
- Сертификаты соответствия на поставляемую продукцию (по желанию клиента).
- Тестирование поставляемой продукции.
- Поставку компонентов, требующих военную и космическую приемку.
- Входной контроль качества.
- Наличие сертификата ISO.

В составе нашей компании организован Конструкторский отдел, призванный помогать разработчикам, и инженерам.

Конструкторский отдел помогает осуществить:

- Регистрацию проекта у производителя компонентов.
- Техническую поддержку проекта.
- Защиту от снятия компонента с производства.
- Оценку стоимости проекта по компонентам.
- Изготовление тестовой платы монтаж и пусконаладочные работы.



Тел: +7 (812) 336 43 04 (многоканальный)

Email: org@lifeelectronics.ru