

TVP06B6V8-HF Thru. TVP06B601-HF

Breakdown Voltage: 6.8 to 600Volts

Power Dissipation: 600 Watts

RoHS Device

Halogen Free

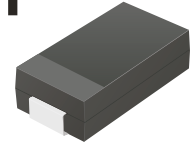

Features

- Glass passivated chip.
- 600W peak pulse power capability with a 10/1000 μ s waveform, repetitive rate (duty cycle):0.01%
- Low leakage.
- Uni and Bidirectional unit.
- Excellent clamping capability.
- Very fast response time.
- UL recognized file # E349157  Range: TVP06B6V8(C)A thru. TVP06B510(C)A

Mechanical Data

- Case: Molded plastic, JEDEC SMB/DO-214AA
- Epoxy: UL 94V-0 rate flame retardant.
- Lead: solderable per MIL-STD-750, method 2026
- Polarity: Color band denotes cathode end except Bipolar.
- Weight: 0.108 gram (approx.)

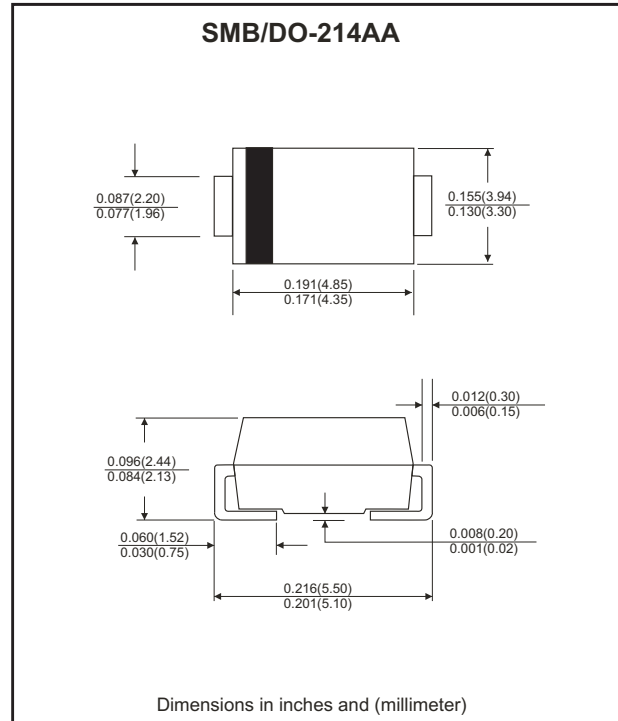

Maximum Ratings and Electrical Characteristics

Rating at 25°C ambient temperature unless otherwise specified.
Single phase, half wave, 60Hz, resistive or inductive load.
For capacitive load, derate current by 20%.

Parameter	Symbol	Value	Units
Peak power dissipation with a 10/1000 μ s waveform (Note 1)	P _{PP}	600	W
Peak pulse current with a 10/1000 μ s waveform (Note 1)	I _{PP}	See Next Table	A
Power dissipation on infinite heatsink at T _L =75°C	P _D	5.0	W
Peak forward surge current, 8.3ms single half sine-wave uni-directional only (Note 2)	I _{FSM}	100	A
Maximum instantaneous forward voltage at 25.0A for uni-directional only (Note 3)	V _F	3.5/5.0	V
Operation junction temperature	T _J	-55 to +150	°C
Storage temperature range	T _{STG}	-55 to +150	°C

Note:

1. Non-repetitive current pulse, per Fig.5 and derated above TA=25°C per Fig.1
2. Measured on 8.3 ms single half sine-wave or equivalent square wave, duty cycle = 4 pulse per minute maximum.
3. V_F<3.5V for devices of V_{BR} <200V and V_F <5.0V for devices of V_{BR} >201V.

Company reserves the right to improve product design , functions and reliability without notice.

REV:B

Rating and Characteristics Curves (TVP06B6V8-HF Thru. TVP06B601-HF)

Fig.1 - Pulse Derating Curve



Fig.2 - Maximum Non-Repetitive Surge Current



Fig.3 - Steady State Power Derating Curve

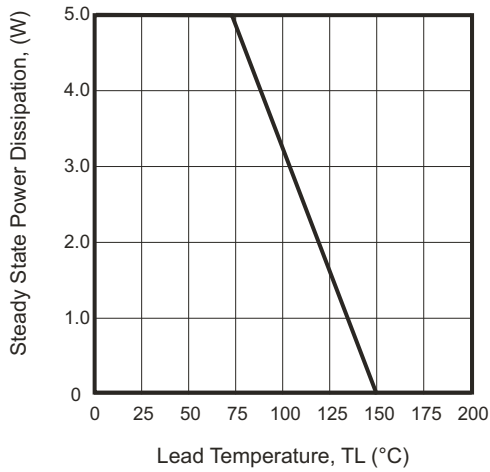

Fig.4 - Peak Pulse Power Rating Curve

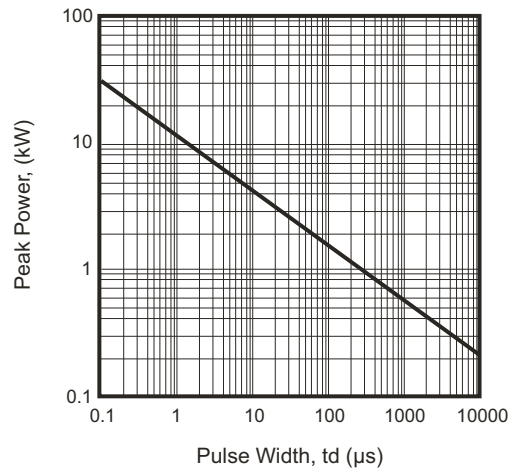

Fig.5 - Pulse Waveform

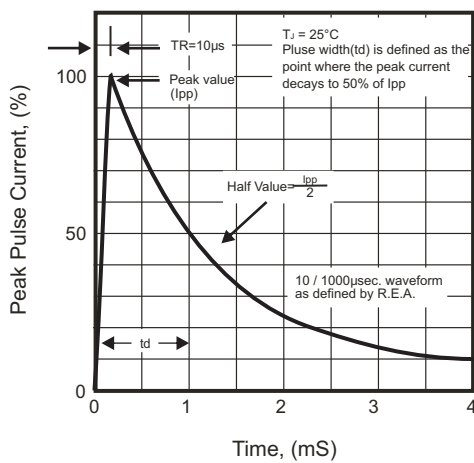
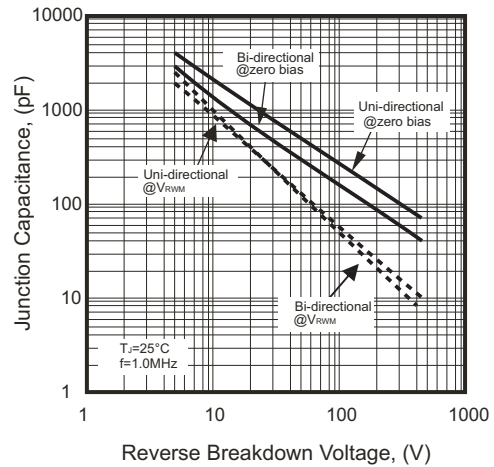

Fig.6 - Typical Junction Capacitance



SMD Transient Voltage Suppressor



Electrical Characteristics (TVP06B6V8-HF Thru. TVP06B601-HF)

Part No.	Breakdown voltage V _{BR} @ I _T			Maximum Reverse Leakage @V _{RRWM} I _R (uA)	Working Peak Reverse Voltage V _{RRWM} (V)	Maximum Reverse Surge Current I _{PP} (A)	Maximum Clamping Voltage @I _{PP} V _C (V)	Device Marking Code	
	Min. (V)	Max. (V)	I _T (mA)					UNI	BI
TVP06B6V8(C)A-HF	6.46	7.14	10	1000	5.8	57.14	10.5	6V8A	6V8C
TVP06B7V5(C)A-HF	7.13	7.88	10	500	6.4	53.10	11.3	7V5A	7V5C
TVP06B8V2(C)A-HF	7.79	8.61	10	200	7.0	49.59	12.1	8V2A	8V2C
TVP06B9V1(C)A-HF	8.65	9.56	1	50	7.8	44.78	13.4	9V1A	9V1C
TVP06B100(C)A-HF	9.50	10.50	1	10	8.6	41.38	14.5	10A	10C
TVP06B110(C)A-HF	10.45	11.55	1	5	9.4	38.46	15.6	11A	11C
TVP06B120(C)A-HF	11.40	12.60	1	5	10.2	35.93	16.7	12A	12C
TVP06B130(C)A-HF	12.35	13.65	1	1	11.1	32.97	18.2	13A	13C
TVP06B150(C)A-HF	14.25	15.75	1	1	12.8	28.30	21.2	15A	15C
TVP06B160(C)A-HF	15.20	16.80	1	1	13.6	26.67	22.5	16A	16C
TVP06B180(C)A-HF	17.10	18.90	1	1	15.3	23.81	25.2	18A	18C
TVP06B200(C)A-HF	19.00	21.00	1	1	17.1	21.66	27.7	20A	20C
TVP06B220(C)A-HF	20.90	23.10	1	1	18.8	19.61	30.6	22A	22C
TVP06B240(C)A-HF	22.80	25.20	1	1	20.5	18.07	33.2	24A	24C
TVP06B270(C)A-HF	25.65	28.35	1	1	23.1	16.00	37.5	27A	27C
TVP06B300(C)A-HF	28.50	31.50	1	1	25.6	14.49	41.4	30A	30C
TVP06B330(C)A-HF	31.35	34.65	1	1	28.2	13.13	45.7	33A	33C
TVP06B360(C)A-HF	34.20	37.80	1	1	30.8	12.02	49.9	36A	36C
TVP06B390(C)A-HF	37.05	40.95	1	1	33.3	11.13	53.9	39A	39C
TVP06B430(C)A-HF	40.85	45.15	1	1	36.8	10.12	59.3	43A	43C
TVP06B470(C)A-HF	44.65	49.35	1	1	40.2	9.26	64.8	47A	47C
TVP06B510(C)A-HF	48.45	53.55	1	1	43.6	8.56	70.1	51A	51C
TVP06B560(C)A-HF	53.20	58.80	1	1	47.8	7.79	77.0	56A	56C
TVP06B620(C)A-HF	58.90	65.10	1	1	53.0	7.06	85.0	62A	62C
TVP06B680(C)A-HF	64.60	71.40	1	1	58.1	6.52	92.0	68A	68C
TVP06B750(C)A-HF	71.25	78.75	1	1	64.1	5.83	103.0	75A	75C
TVP06B820(C)A-HF	77.90	86.10	1	1	70.1	5.31	113.0	82A	82C
TVP06B910(C)A-HF	86.45	95.55	1	1	77.8	4.80	125.0	91A	91C
TVP06B101(C)A-HF	95.00	105.00	1	1	85.5	4.38	137.0	100A	100C
TVP06B111(C)A-HF	104.50	115.50	1	1	94.0	3.95	152.0	110A	110C
TVP06B121(C)A-HF	114.00	126.00	1	1	102.0	3.64	165.0	120A	120C
TVP06B131(C)A-HF	123.50	136.50	1	1	111.0	3.35	179.0	130A	130C
TVP06B151(C)A-HF	142.50	157.50	1	1	128.0	2.90	207.0	150A	150C
TVP06B161(C)A-HF	152.00	168.00	1	1	136.0	2.74	219.0	160A	160C
TVP06B171(C)A-HF	161.50	178.50	1	1	145.0	2.56	234.0	170A	170C
TVP06B181(C)A-HF	171.00	189.00	1	1	154.0	2.44	246.0	180A	180C
TVP06B201(C)A-HF	190.00	210.00	1	1	171.0	2.19	274.0	200A	200C
TVP06B221(C)A-HF	209.00	231.00	1	1	185.0	1.83	328.0	220A	220C
TVP06B251(C)A-HF	237.50	262.50	1	1	214.0	1.74	344.0	250A	250C
TVP06B301(C)A-HF	285.00	315.00	1	1	256.0	1.45	414.0	300A	300C
TVP06B351(C)A-HF	332.50	367.50	1	1	299.3	1.24	482.0	350A	350C
TVP06B381(C)A-HF	361.00	399.00	1	1	324.9	1.14	524.4	380A	380C
TVP06B401(C)A-HF	380.00	420.00	1	1	342.0	1.09	548.0	400A	400C
TVP06B441(C)A-HF	418.00	462.00	1	1	376.2	0.99	607.2	440A	440C
TVP06B501(C)A-HF	475.00	525.00	1	1	427.5	0.87	690.0	500A	500C
TVP06B521(C)A-HF	494.00	546.00	1	1	444.6	0.84	717.6	520A	520C
TVP06B551(C)A-HF	522.50	577.50	1	1	470.3	0.79	759.0	550A	550C
TVP06B601(C)A-HF	570.00	630.00	1	1	513.0	0.72	828.0	600A	600C

- Note: 1) Suffix A denotes 5% tolerance devices.
 2) Add suffix "C" or "CA" after part number to specify Bi-directional devices.
 3) For Bi-Directional devices having V_R of 10 volts and under, the I_R limit is double.

Company reserves the right to improve product design, functions and reliability without notice.

REV:B

Reel Taping Specification



DO-214AA (SMB)	SYMBOL	A	B	C	d	D	D1	D2
	(mm)	3.67 ± 0.10	5.69 ± 0.10	4.50 (max)	1.55 ± 0.10	330.00	50.00 (min)	13.00 ± 0.20
	(inch)	0.144 ± 0.004	0.224 ± 0.004	0.177 (max)	0.061 ± 0.004	13.000	1.969 (min)	0.512 ± 0.008

DO-214AA (SMB)	SYMBOL	E	F	P	P0	P1	W	W1
	(mm)	1.75 ± 0.10	5.50 ± 0.05	8.00 ± 0.10	4.00 ± 0.10	2.00 ± 0.05	12.00 ± 0.30	18.40 (max)
	(inch)	0.069 ± 0.004	0.217 ± 0.002	0.315 ± 0.004	0.157 ± 0.004	0.079 ± 0.002	0.472 ± 0.012	0.724 (max)

Company reserves the right to improve product design, functions and reliability without notice.

REV:B

Marking Code

1. **C**: COMCHIP

2. **○**: Package

○	PKG
A	SMA
B	SMB
C	SMC

3. XXX/XXXX: Marking code (see Page. 3)

4. **█**: Cathod Band



Suggested PAD Layout

SIZE	DO-214AA(SMB)	
	(mm)	(inch)
A	5.60	0.220
B	2.16 MAX	0.085 MAX
C	1.52 MIN	0.060 MIN
D	2.18 MIN	0.086 MIN



Standard Packaging

Case Type	REEL PACK	
	REEL (pcs)	Reel Size (inch)
DO-214AA (SMB)	3,000	13

Компания «Life Electronics» занимается поставками электронных компонентов импортного и отечественного производства от производителей и со складов крупных дистрибьюторов Европы, Америки и Азии.

С конца 2013 года компания активно расширяет линейку поставок компонентов по направлению коаксиальный кабель, кварцевые генераторы и конденсаторы (керамические, пленочные, электролитические), за счёт заключения дистрибьюторских договоров

Мы предлагаем:

- Конкурентоспособные цены и скидки постоянным клиентам.
- Специальные условия для постоянных клиентов.
- Подбор аналогов.
- Поставку компонентов в любых объемах, удовлетворяющих вашим потребностям.
- Приемлемые сроки поставки, возможна ускоренная поставка.
- Доставку товара в любую точку России и стран СНГ.
- Комплексную поставку.
- Работу по проектам и поставку образцов.
- Формирование склада под заказчика.
- Сертификаты соответствия на поставляемую продукцию (по желанию клиента).
- Тестирование поставляемой продукции.
- Поставку компонентов, требующих военную и космическую приемку.
- Входной контроль качества.
- Наличие сертификата ISO.

В составе нашей компании организован Конструкторский отдел, призванный помогать разработчикам, и инженерам.

Конструкторский отдел помогает осуществить:

- Регистрацию проекта у производителя компонентов.
- Техническую поддержку проекта.
- Защиту от снятия компонента с производства.
- Оценку стоимости проекта по компонентам.
- Изготовление тестовой платы монтаж и пусконаладочные работы.



Тел: +7 (812) 336 43 04 (многоканальный)

Email: org@lifeelectronics.ru