

RF to IF Single Downconverting Mixer

600MHz to 1060MHz

GENERAL DESCRIPTION

This document describes the specification for the IDTF1701 Zero-Distortion™ Lowband RF to IF Single Downconverting Mixer. This device is part of a series of mixers using lowside or highside LO injection options for all UTRA frequency bands. See the Part# Matrix for the detail of all devices in this series.

The F1701 single channel device is designed to operate with a single 5V supply. It is optimized for operation in a Multi-mode, Multi-carrier BaseStation Receiver over the frequency range from 600MHz to 1060MHz using either lowside or highside LO. IF frequencies from 70MHz to 300MHz are supported. Nominally, the device offers +43dBm Output IP3 using HS LO with 184mA of I_{cc} .

COMPETITIVE ADVANTAGE

In typical basestation receivers, the RF to IF mixer dominates the linearity performance for the entire receive system. The Zero-Distortion™ family of mixers dramatically improve the maximum signal levels (IM_3 tones) that the BTS can withstand at a desired Signal to Noise Ratio (SNR.) Zero-Distortion™ technology allows realization of either benefit. In basestation transmitters, digital pre-distortion (DPD) is employed to improve the Transmitter performance. By utilizing an ultra-linear mixer in the DPD RX path, such as the IDTF1701, the ACLR and/or power consumption of the full Tx system can be improved significantly. This is because the F1701 can directly drive an ADC through an Anti-Alias filter. Downstream amplification is not necessary in the DPD application.

- ✓ IP_{30} : ↑ **9 dB**
- ✓ Dissipation: ↓ **14%**
- ✓ Allows for higher RF gain improving **Sensitivity**
- ✓ Eliminates the need for an ADC driver or IF VGA in DPD linearization path



FEATURES

- Ideal for Multi-Carrier Systems
- Lowside or Highside LO
- 11.8dB Gain
- Ultra linear +43dBm IP_{30} using HS LO or +42dBm IP_{30} using LS LO
- 9.2dB NF
- 200 Ω output impedance
- Wide flat performance IF BW
- Drives ADC directly for DPD applications
- Low Power Consumption
- 5x5 20 pin package
- Standby Mode

DEVICE BLOCK DIAGRAM

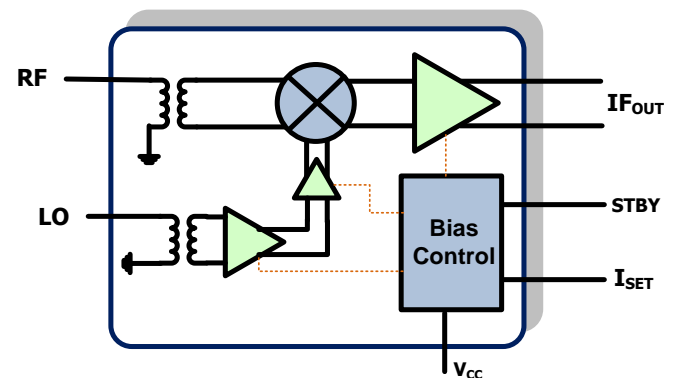

ORDERING INFORMATION

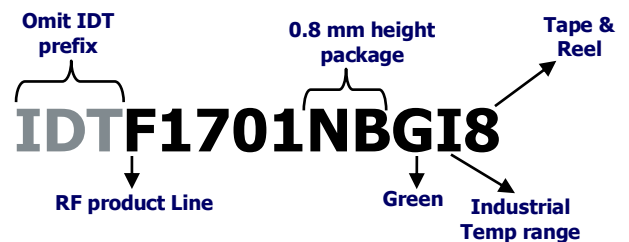

PART# MATRIX

| Part# | RF Range | UTRA bands | IF freq range | Typ. Gain | Injection |
|-------|-------------|---|---------------|-----------|-----------|
| F1701 | 600 - 1060 | 5, 6, 8, 12, 13, 14, 17, 18, 19, 20, 26 | 70 - 300 | 11.8 | Both |
| F1751 | 1400 - 2500 | 1, 2, 3, 4, 9, 10, 11, 21, 23, 24, 25, 33, 34, 35, 36, 37, 39, 40 | 50 - 500 | 11.8 | Both |
| F1763 | 2000 - 2900 | 7, 38, 40, 41 | 50 - 500 | 11.7 | Both |



ABSOLUTE MAXIMUM RATINGS

| | |
|---|---|
| VCC to GND | -0.3V to +5.5V |
| STBY | -0.3V to (VCC + 0.3V) |
| IF_OUT+, IF_OUT-, RF_IN | -0.3V to (VCC + 0.3V) |
| LO_IN | -0.3V to +0.3V |
| IF_SET to GND, IF_BIAS to GND | -0.3V to +1.2V |
| RF Input Power | +20dBm |
| Continuous Power Dissipation | 1.3W |
| θ_{JA} (Junction – Ambient) | +40°C/W |
| θ_{JC} (Junction – Case) The Case is defined as the exposed paddle | +3°C/W |
| Operating Temperature Range (Case Temperature) | $T_C = -40^\circ\text{C}$ to $+105^\circ\text{C}$ |
| Maximum Junction Temperature | 150°C |
| Storage Temperature Range | -65°C to +150°C |
| Lead Temperature (soldering, 10s) | +260°C |

Stresses above those listed above may cause permanent damage to the device. Functional operation of the device at these or any other conditions above those indicated in the operational section of this specification is not implied. Exposure to absolute maximum rating conditions for extended periods may affect device reliability.



IDTF1701 RECOMMENDED OPERATING CONDITIONS

| Parameter | Comment | Symbol | min | typ | max | Units |
|-----------------------------|---|-------------------|------|-----|------|-------|
| Supply Voltage(s) | All V _{CC} pins | V _{CC} | 4.75 | | 5.25 | V |
| Operating Temperature Range | Case Temperature | T _{CASE} | -40 | | +105 | degC |
| RF Freq Range | Sets LO freq range | F _{RF1} | 698 | | 960 | MHz |
| Oversample RF Range | <ul style="list-style-type: none">▪ Measure gain at 200MHz IF▪ FLO = 800MHz, 1260MHz | F _{RF2} | 600 | | 1060 | |
| LO Freq Range | | | 630 | | 1260 | |
| IF Freq Range | Sets LO freq range | F _{IF} | 70 | | 300 | |



RF to IF Single Downconverting Mixer

600MHz to 1060MHz

IDTF1701 SPECIFICATION

Refer to Typical Application Circuit when operated with $V_{CC} = +5.0V$, $T_C = +25^\circ C$, $F_{RF} = 950\text{ MHz}$, $F_{IF} = 200\text{ MHz}$, $F_{LO} = 1150\text{ MHz}$, $P_{LO} = 0\text{ dBm}$, output power = +1dBm per tone, STBY = GND unless otherwise noted. Transformer loss is de-embedded unless otherwise noted.

| Parameter | Comment | Symbol | min | typ | max | units |
|--------------------------|--|------------------|-----------------------|-------------|------------------------|---------|
| Logic Input High | For Standby Pin | V_{IH} | 2 | | | V |
| Logic Input Low | For Standby Pin | V_{IL} | | | 0.8¹ | V |
| Logic Current | For Standby Pin | I_{IH}, I_{IL} | -1 | | +1 | μA |
| Supply Current | Total V_{CC} | I_{SUPP} | | 184 | 210 | mA |
| Supply Current | Standby Mode ▪ STBY = V_{IH} | I_{STBY} | | 20 | 25 | mA |
| LO Power | | P_{LO} | -3² | | +3 | dBm |
| Settling Time | <ul style="list-style-type: none"> • Pin = -13 dBm • Gate STBY from V_{IH} to V_{IL} • Time for IF Signal to settle to within 1 dB of final value | T_{SETT} | | 130 | | nsec |
| Gain | <ul style="list-style-type: none"> ▪ $F_{RF} = 600\text{MHz}$ ▪ $F_{LO} = 800\text{MHz}$ | G_{LB} | | 11.3 | | dB |
| | <ul style="list-style-type: none"> ▪ $F_{RF} = 950\text{MHz}$ ▪ $F_{LO} = 1150\text{MHz}$ | G_{MB} | 10.9 | 11.8 | 12.6 | |
| | <ul style="list-style-type: none"> ▪ $F_{RF} = 1060\text{MHz}$ ▪ $F_{LO} = 1260\text{MHz}$ | G_{HB} | | 11.4 | | |
| Noise Figure | | NF | | 9.2 | | dB |
| NF w/Blocker | <ul style="list-style-type: none"> ▪ -100 MHz offset blocker ▪ $P_{BLKR} = +4\text{ dBm}$ | NF_{BLK} | | 17.5 | | dB |
| Output IP3 | <ul style="list-style-type: none"> ▪ $F_{RF1} = 950\text{MHz}$ ▪ $F_{LO} = 1150\text{MHz}$ ▪ $P_{IN} = -10\text{dBm}$ per tone ▪ 5MHz Tone Separation | $IP3_{oHSLO}$ | 36 | 43 | | dBm |
| | <ul style="list-style-type: none"> ▪ $F_{RF1} = 950\text{MHz}$ ▪ $F_{LO} = 750\text{MHz}$ ▪ $P_{IN} = -10\text{dBm}$ per tone ▪ 5MHz Tone Separation | $IP3_{oLSLO}$ | | 42 | | |
| 2RF – 2LO rejection | <ul style="list-style-type: none"> ▪ $P_{RF} = -10\text{dBm}$ ▪ Frequency = 1050MHz | 2x2 | | -77 | -72 | dBc |
| 2 nd Harmonic | <ul style="list-style-type: none"> ▪ $P_{out} = -3\text{dBm}$ | H2 | | -78 | -72 | dBc |



IDTF1701 SPECIFICATION - CONTINUED

Refer to Typical Application Circuit when operated with $V_{CC} = +5.0V$, $T_C = +25^\circ C$, $F_{RF} = 950\text{ MHz}$, $F_{IF} = 200\text{ MHz}$, $F_{LO} = 1150\text{ MHz}$, $P_{LO} = 0\text{ dBm}$, output power = +1dBm per tone, STBY = GND unless otherwise noted. Transformer loss is de-embedded unless otherwise noted.

| | | | | | | |
|-------------------------------|--|-----------------|-----------|-------|------|----------|
| IM2 Sum Product (IM2+) | <ul style="list-style-type: none"> ▪ Pout = -3 dBm each tone ▪ $F_{IF1} = 200\text{ MHz}$, $F_{IF2} = 205\text{ MHz}$ ▪ IM2 Product = 405 MHz | IM2+ | | -75 | -69 | dBc |
| IM2 Diff Product (IM2-) | <ul style="list-style-type: none"> ▪ Pout = -3 dBm each tone ▪ $F_{IF1} = 200\text{ MHz}$, $F_{IF2} = 205\text{ MHz}$ ▪ IM2 Product = 5 MHz | IM2- | | -80 | -75 | dBc |
| 1dB output compression | Output referred | $P1dB_O$ | 17 | 21 | | dBm |
| 1dB input compression | Input referred | $P1dB_I$ | | 10.2 | | dBm |
| Gain Comp. w/blocker | <ul style="list-style-type: none"> ▪ Unmodulated blocker ▪ $P_{in} = -4\text{ dBm}$, -100MHz offset ▪ Signal Pin Tone = -20dBm ▪ Measure Δ gain of signal | ΔG_{AC} | | 0.1 | 0.15 | dB |
| Gain Ripple | <ul style="list-style-type: none"> ▪ Fixed LO = 1100 MHz ▪ RF = 770 to 1050 MHz ▪ IF = 50 to 330 MHz | | | 1 | 1.2 | dB |
| RF Input Impedance | Single Ended | Z_{RF} | | 50 | | Ω |
| LO port Impedance | Single Ended | Z_{LO} | | 50 | | |
| IF Output Impedance | Differential | Z_{IF} | | 200 | | |
| RF Input Return Loss | Single Ended | RF_{RL} | 14 | 20 | | dB |
| LO port Return Loss | Single Ended | LO_{RL} | 18 | 22 | | dB |
| IF Output Return Loss | Differential | IF_{RL} | 17 | 19 | | dB |
| LO to IF leakage ² | | ISO_{LI} | | -55 | -39 | dBm |
| RF to IF leakage | Referenced to Pin = -10dBm | ISO_{RI} | | -41 | -34 | dBc |
| LO to RF leakage | | ISO_{LR} | | -43.5 | -38 | dBm |

1 – Items in min/max columns in *bold italics* are Guaranteed by Test

2 – All other Items in min/max columns are Guaranteed by Design Characterization



TYPICAL OPERATING CONDITIONS

Unless otherwise noted, the following conditions apply to the Typ Ops Graphs:

- $V_{CC} = +5.0V$
- $STBY = GND$
- $T_C = +25^{\circ}C$
- $F_{RF} = 950\text{ MHz}$
- $F_{IF} = 200\text{ MHz}$
- $F_{LO} = 1150\text{ MHz}$
- $P_{LO} = 0\text{ dBm}$
- $P_{in} = -10\text{ dBm}$ per tone
- Transformer loss is de-embedded for Gain, Output P1dB and OIP3 Graphs

TOCs [IF = 200MHz, HIGH SIDE INJECTION] Gain, OIP3 (1)

Gain vs. T_{CASE}

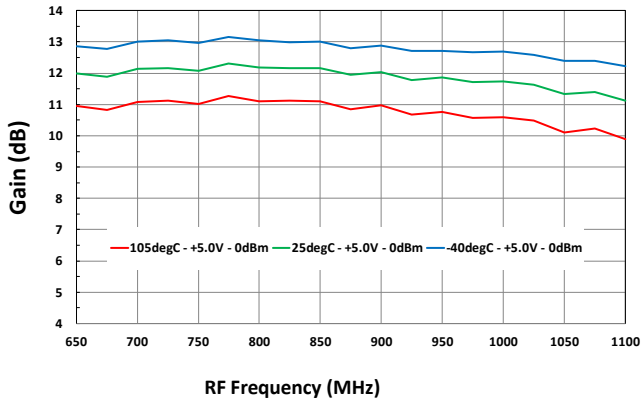

Gain vs. Lo Level

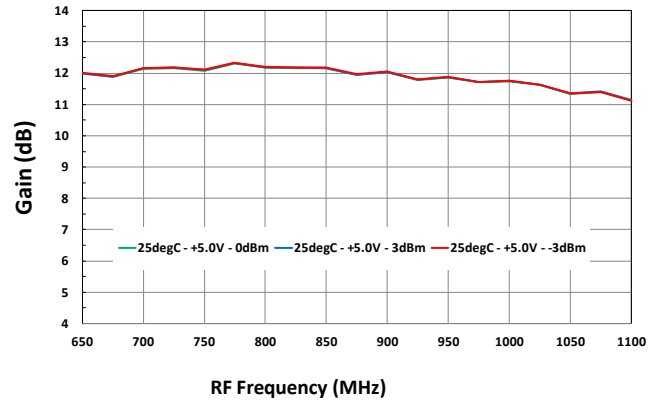

Gain vs. V_{CC}

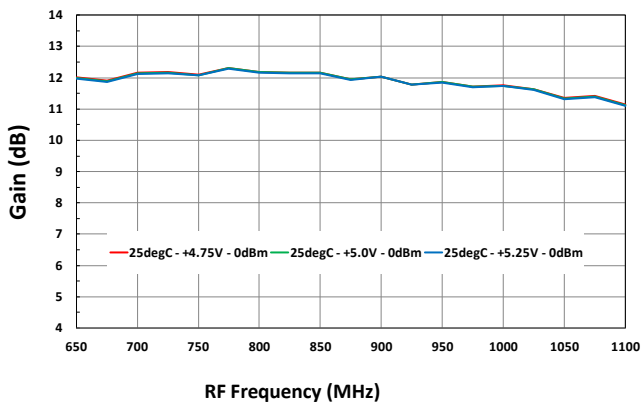

Output IP3 vs. T_{CASE}

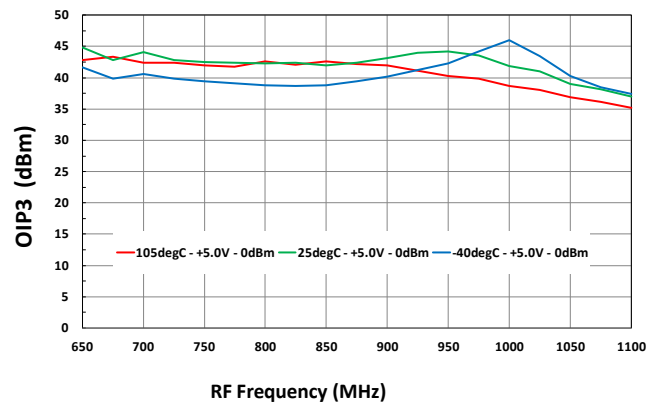

Output IP3 vs. Lo Level

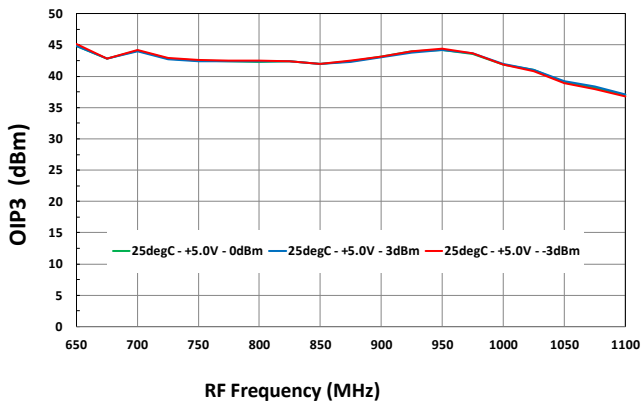

Output IP3 vs. V_{CC}

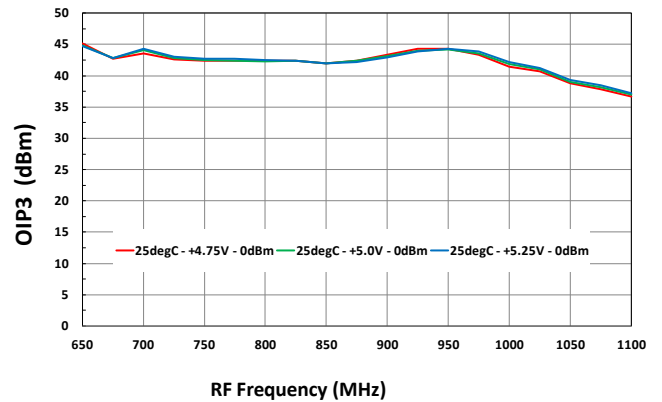

RF to IF Single Downconverting Mixer

600MHz to 1060MHz

TOCs [IF = 200MHz, HIGH SIDE INJECTION] P1dB_o, 2x2 (2)

P1dB_o vs. T_{CASE}

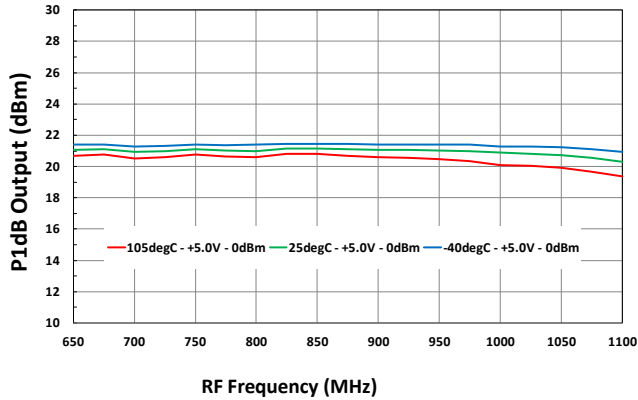

P1dB_o vs. Lo Level

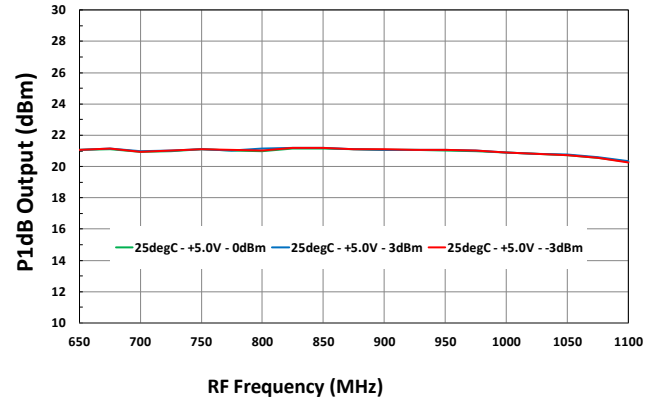

P1dB_o vs. V_{CC}

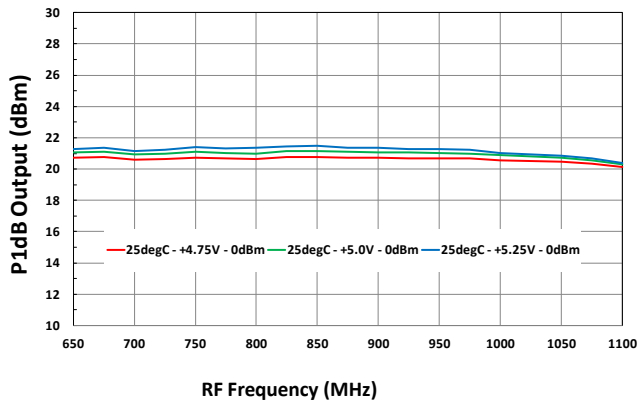

2x2 Rejection vs. T_{CASE}

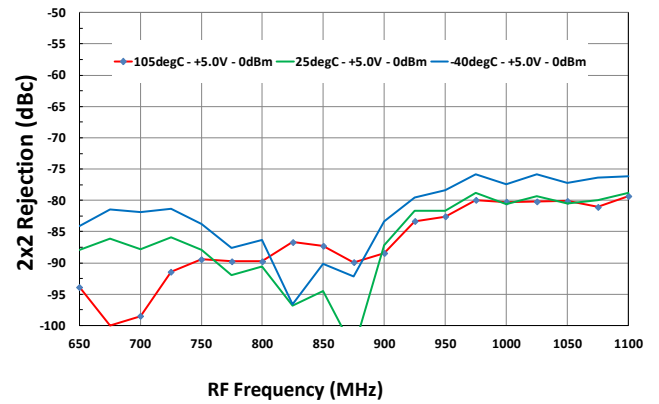

2x2 Rejection vs. Lo Level

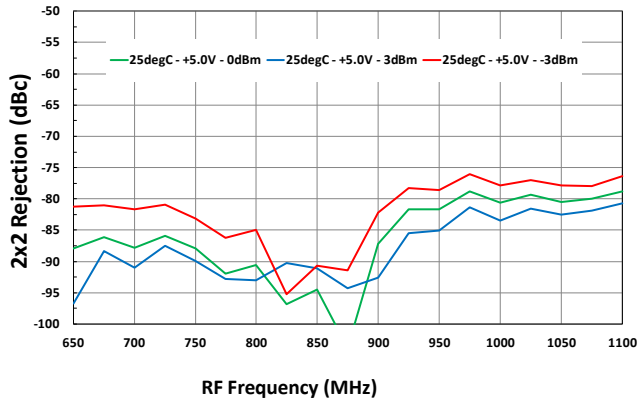

2x2 Rejection vs. V_{CC}

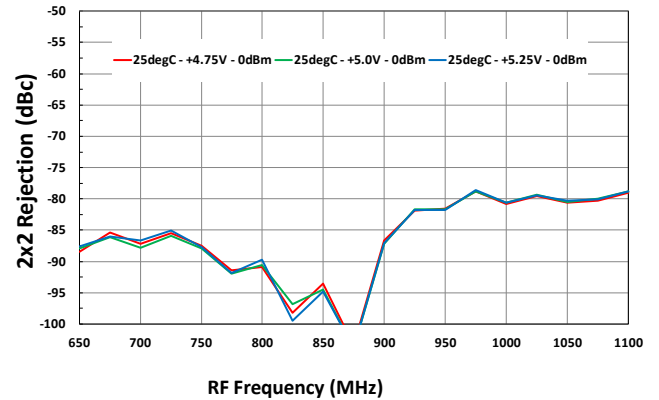

TOCs [IF = 200MHz, HIGH SIDE INJECTION] 3x3, H2 Rejection (3)

3x3 Rejection vs. T_{CASE}

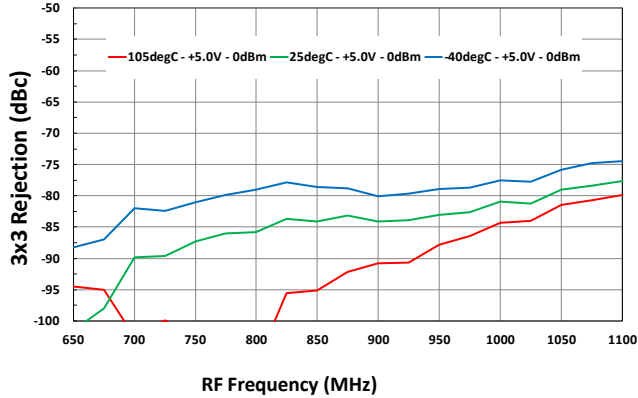

3x3 Rejection vs. Lo Level

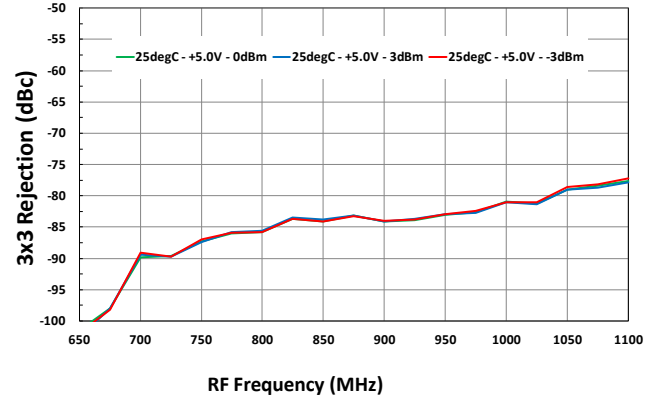

3x3 Rejection vs. V_{CC}

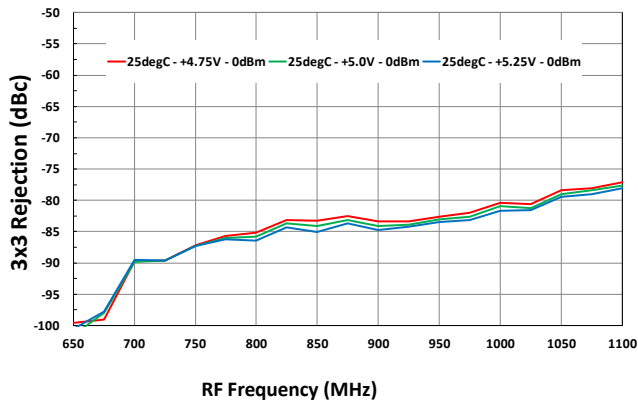

H2 Rejection vs. T_{CASE}

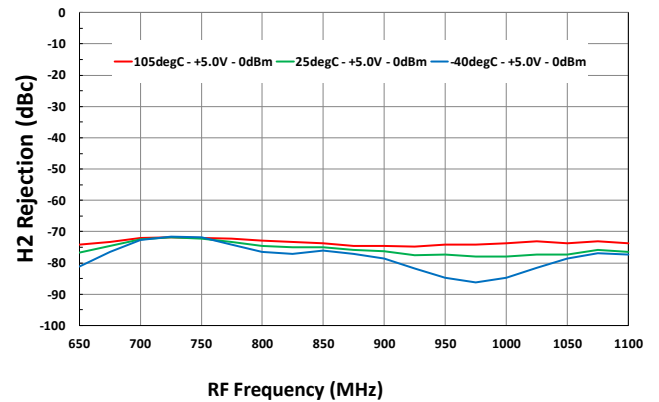

H2 Rejection vs. Lo Level

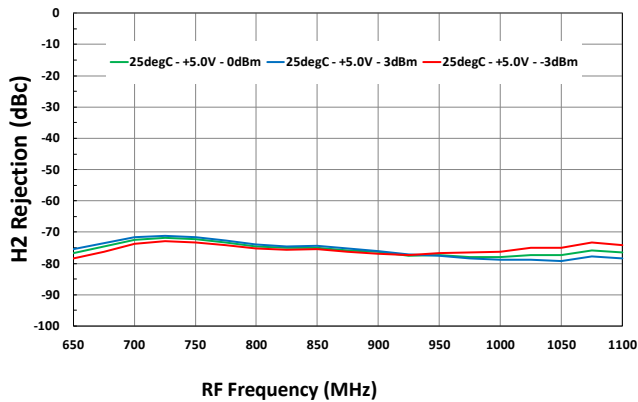

H2 Rejection vs. V_{CC}

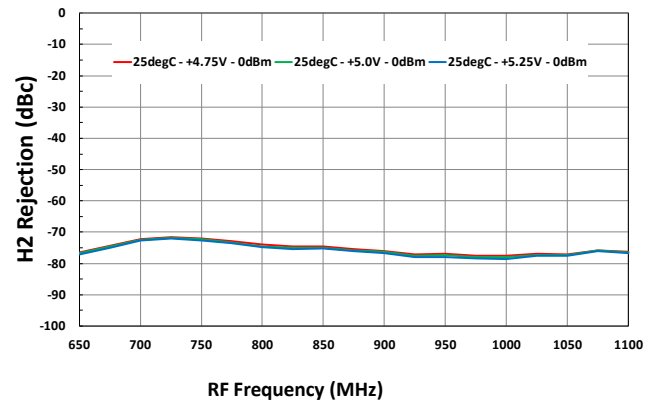

RF to IF Single Downconverting Mixer

600MHz to 1060MHz

TOCs [IF = 200MHz, HIGH SIDE INJECTION] Icc, LO-IF leakage [4]

ICC vs. T_{CASE}

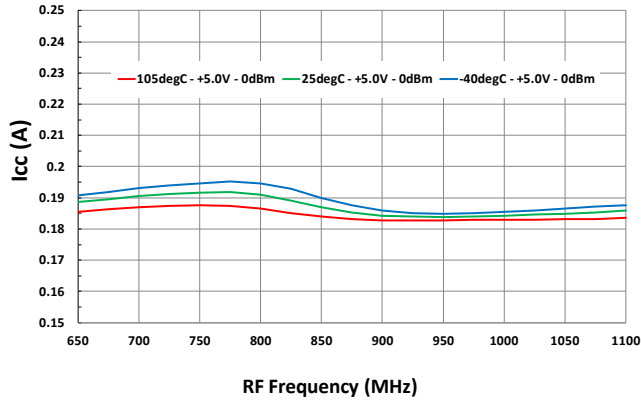

ICC vs. Lo Level

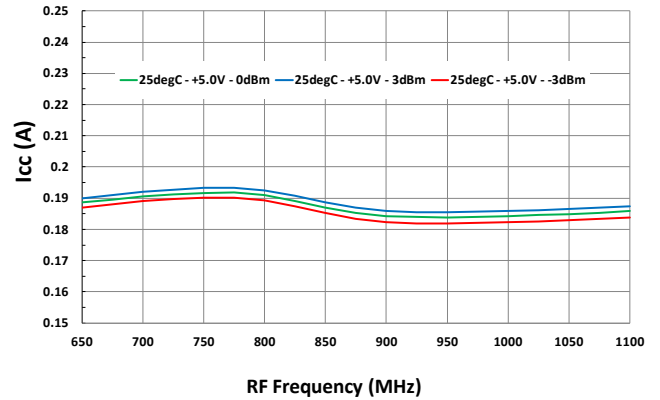

ICC vs. V_{CC}

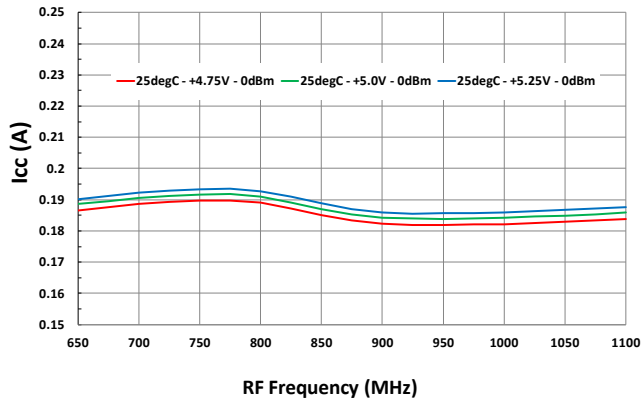

Lo to IF leakage vs. T_{CASE}

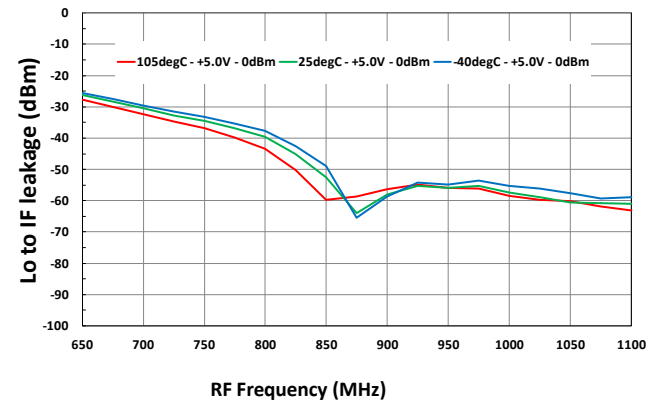

Lo to IF leakage vs. Lo Level

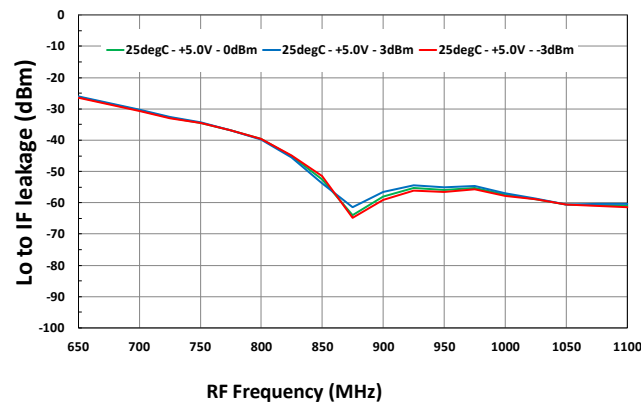

Lo to IF leakage vs. V_{CC}

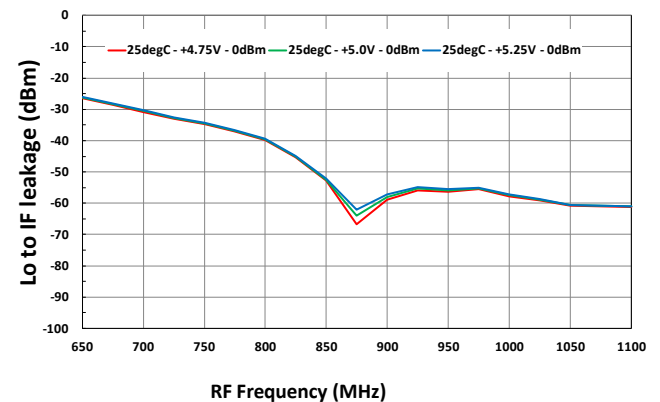

RF to IF Single Downconverting Mixer

600MHz to 1060MHz

TOCs [IF = 200MHz, HIGH SIDE INJECTION] RF to IF leakage, OIP3, HD2 (5)

RF to IF leakage vs. T_{CASE}

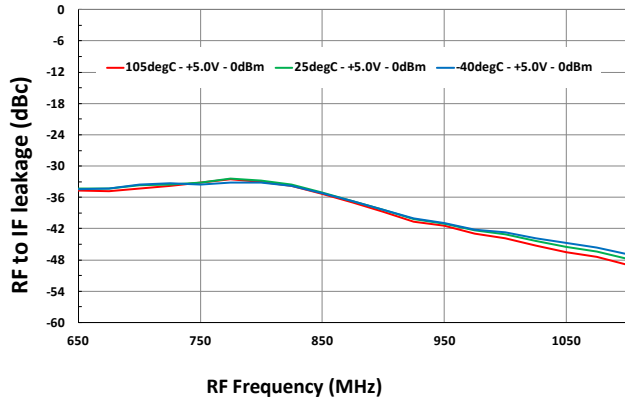

RF to IF leakage vs. Lo Level

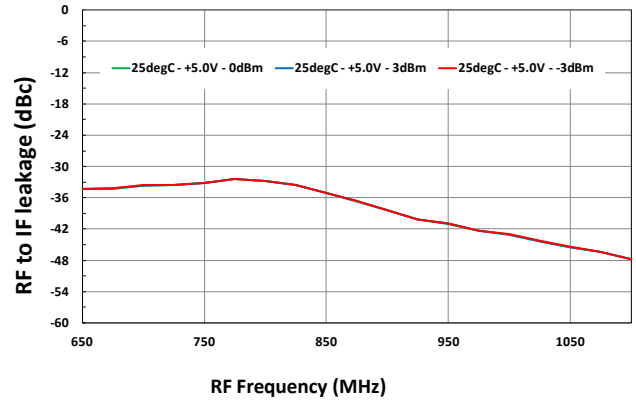

RF to IF leakage vs. Vcc

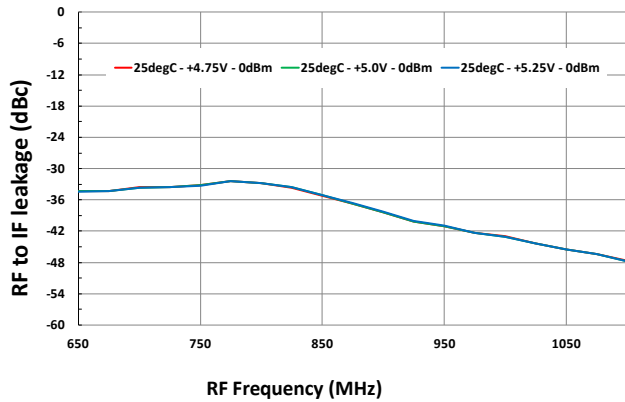

OIP3 vs. Input power

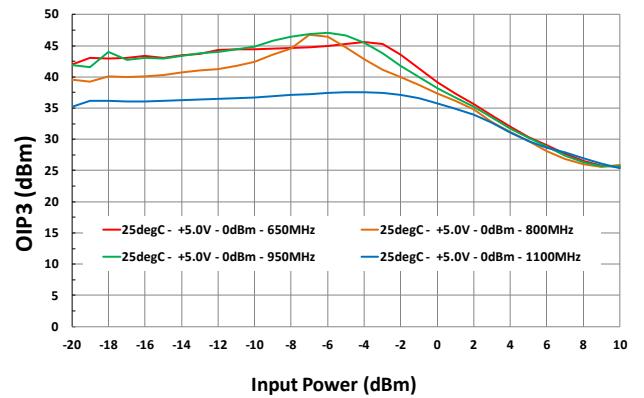

HD2 vs. Input power

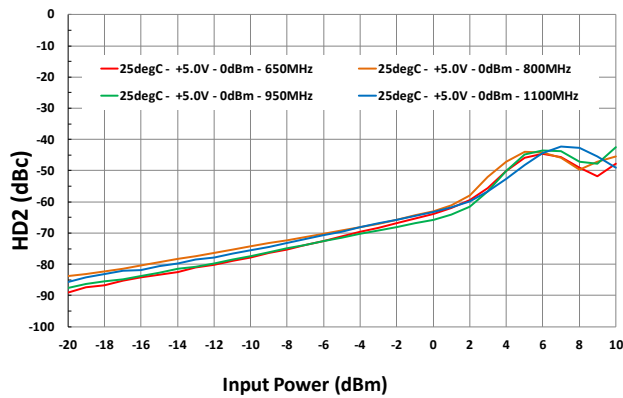

OIP3 vs. Delta Frequency of two tones

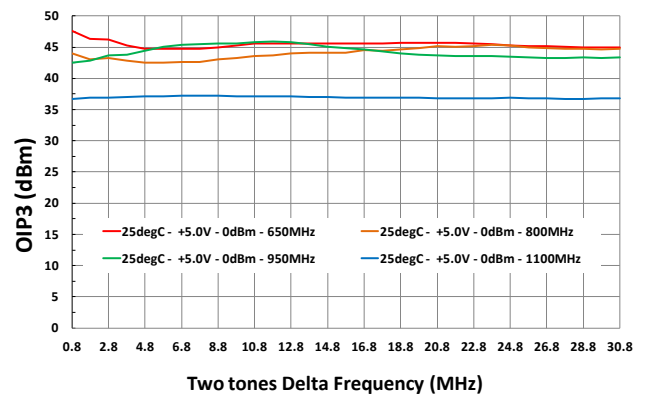

TOCs [IF = 200MHz, LOW SIDE INJECTION] Gain, OIP3 (6)

Gain vs. T_{CASE}

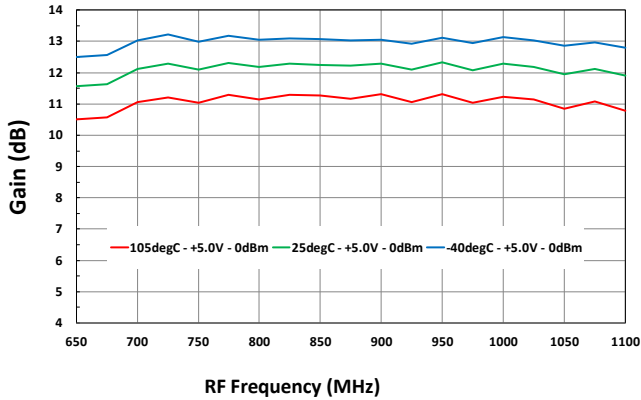

Gain vs. Lo Level

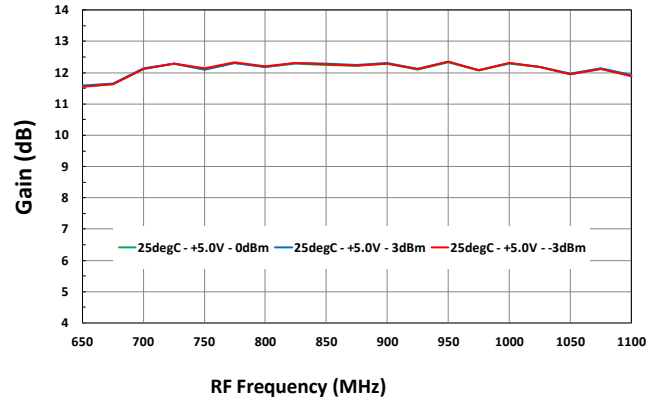

Gain vs. Vcc

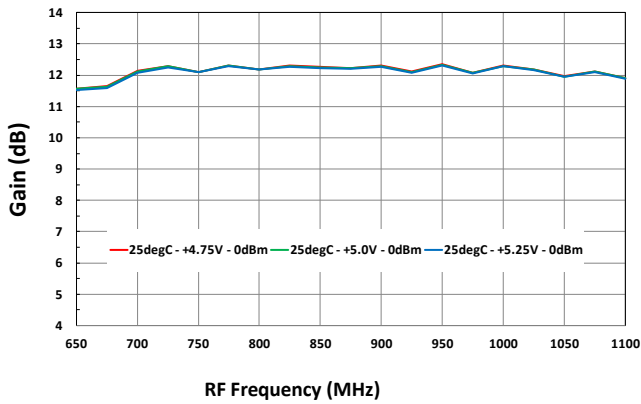

Output IP3 vs. T_{CASE}

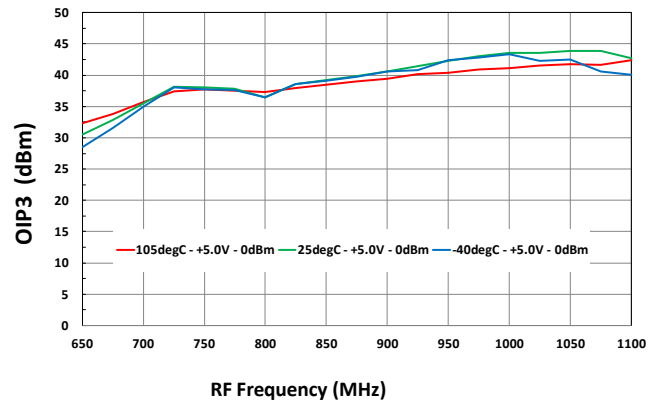

Output IP3 vs. Lo Level

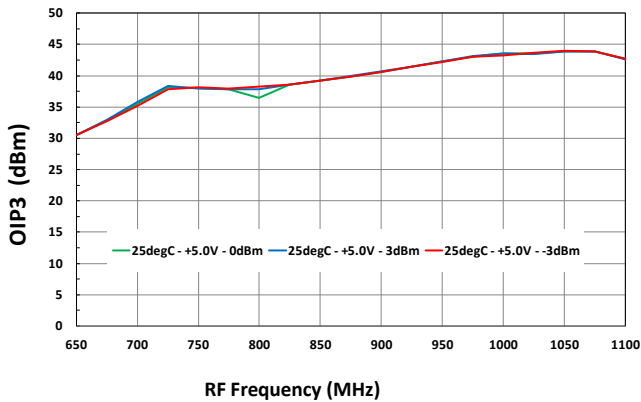

Output IP3 vs. Vcc

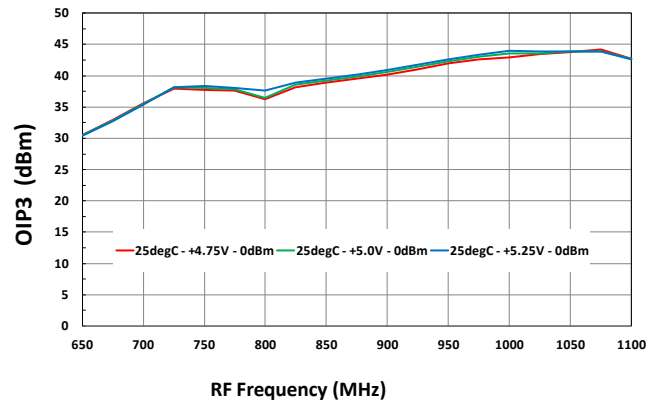

RF to IF Single Downconverting Mixer

600MHz to 1060MHz

TOCs [IF = 200MHz, LOW SIDE INJECTION] P1dB_o, 2x2 (7)

P1dB_o vs. T_{CASE}

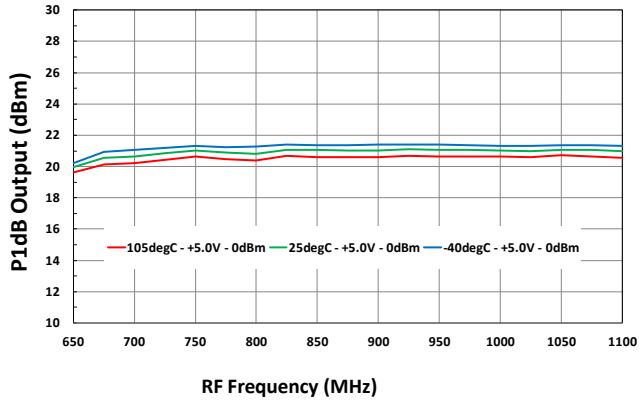

P1dB_o vs. Lo Level

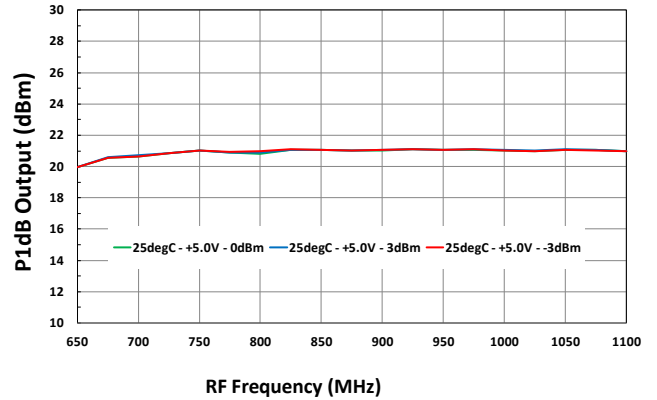

P1dB_o vs. V_{CC}

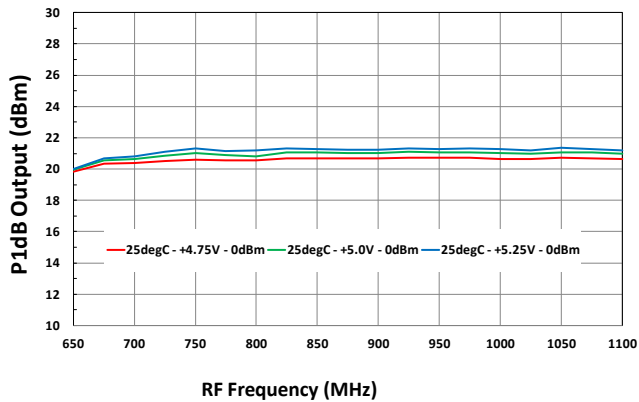

2x2 Rejection vs. T_{CASE}

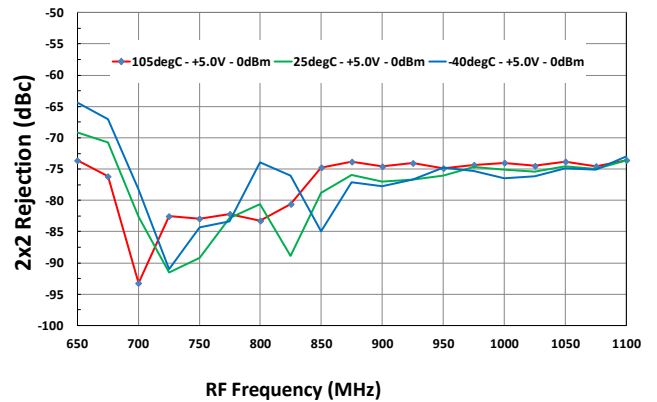

2x2 Rejection vs. Lo Level

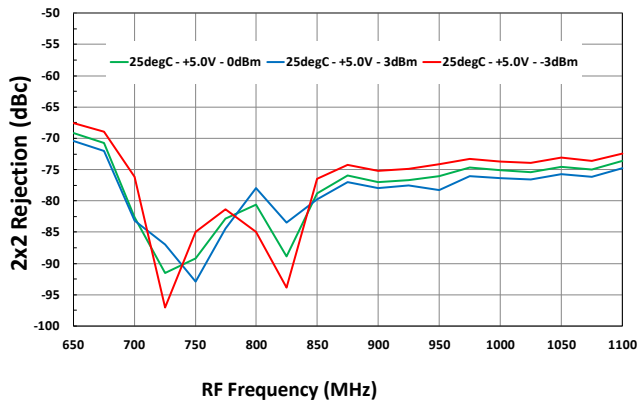

2x2 Rejection vs. V_{CC}

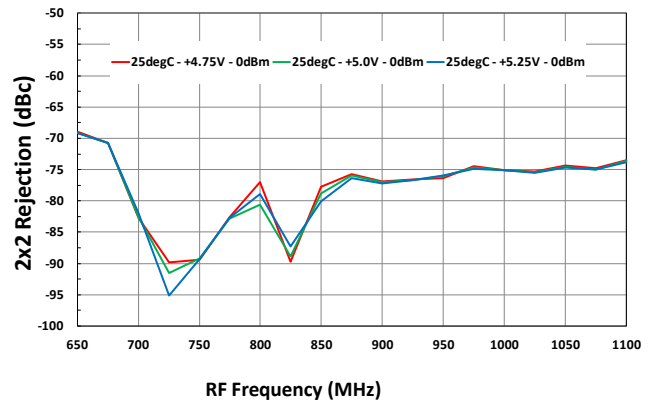

TOCs [IF = 200MHz, LOW SIDE INJECTION] 3x3, H2 Rejection (8)

3x3 Rejection vs. T_{CASE}

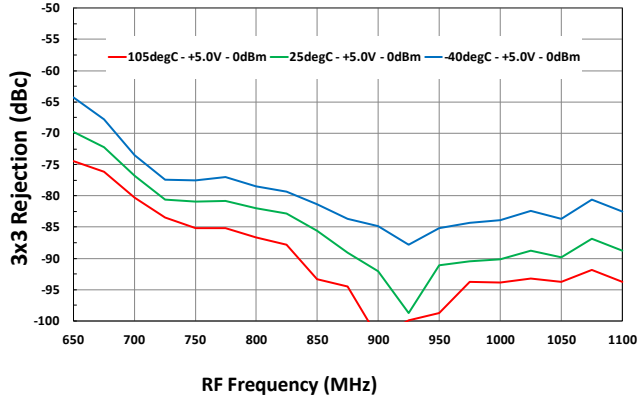

3x3 Rejection vs. Lo Level

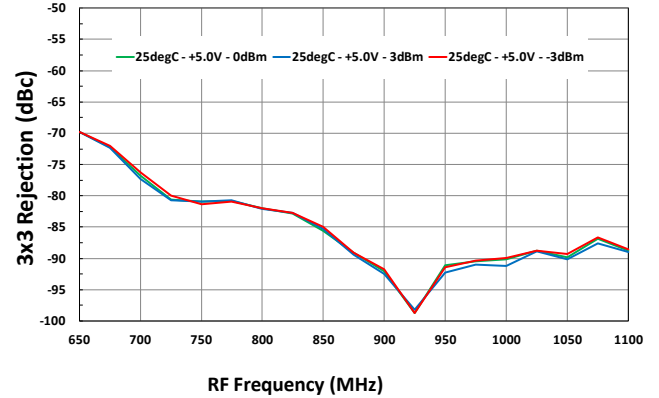

3x3 Rejection vs. V_{CC}

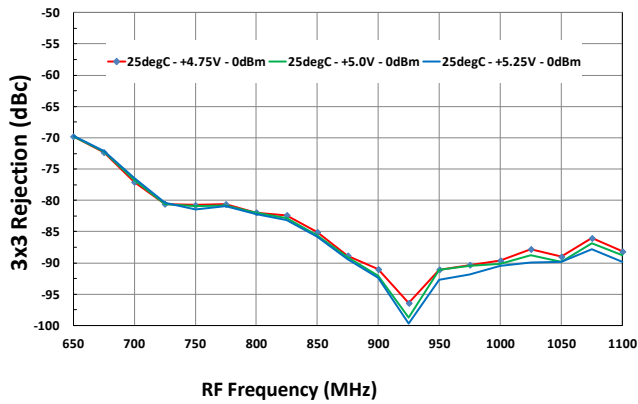

H2 Rejection vs. T_{CASE}

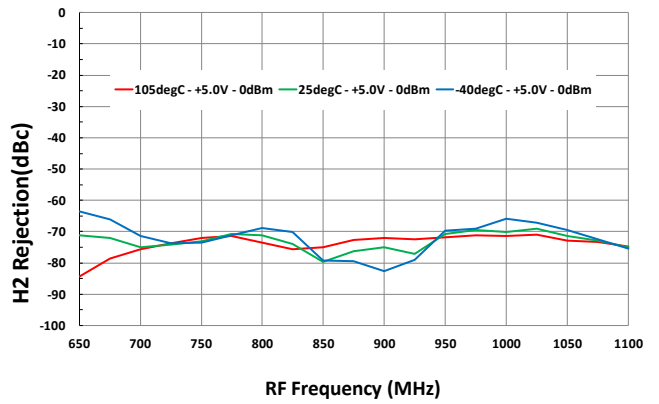

H2 Rejection vs. Lo Level

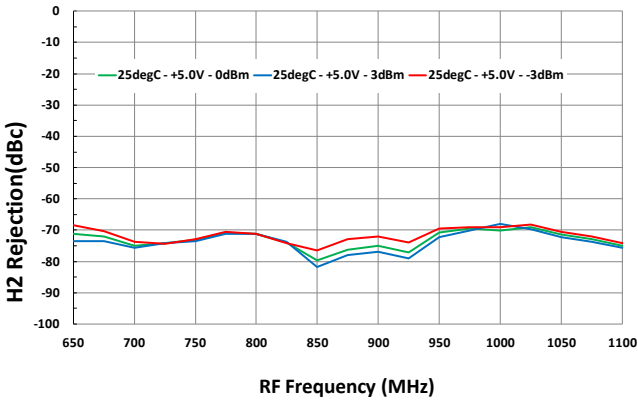

H2 Rejection vs. V_{CC}

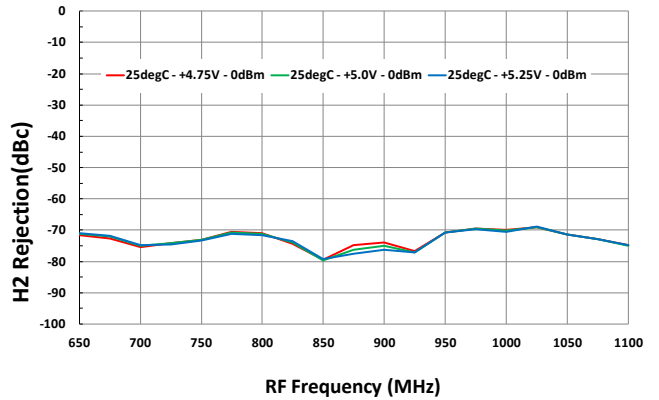

RF to IF Single Downconverting Mixer

600MHz to 1060MHz

TOCs [IF = 200MHz, LOW SIDE INJECTION] Icc, Lo to IF Leakage (9)

Icc vs. T_{CASE}

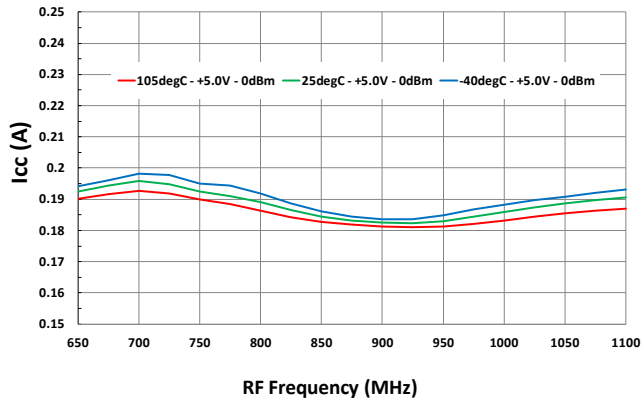

Icc vs. Lo Level

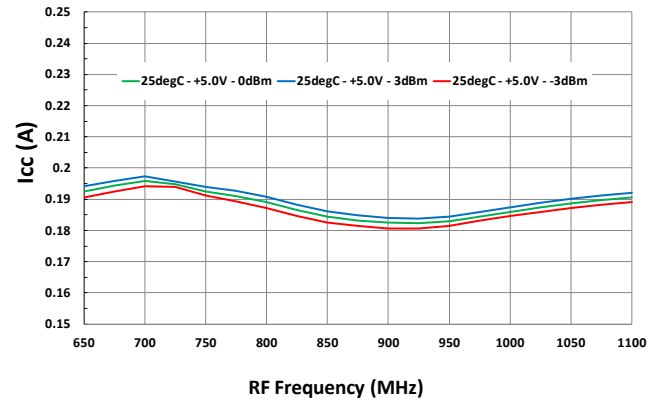

Icc vs. Vcc

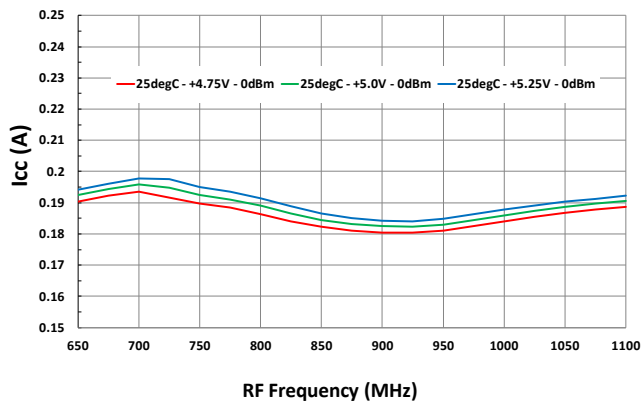

Lo to IF leakage vs. T_{CASE}

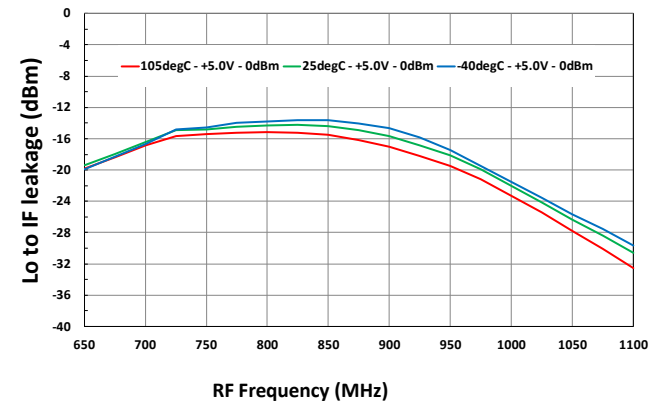

Lo to IF leakage vs. Lo Level

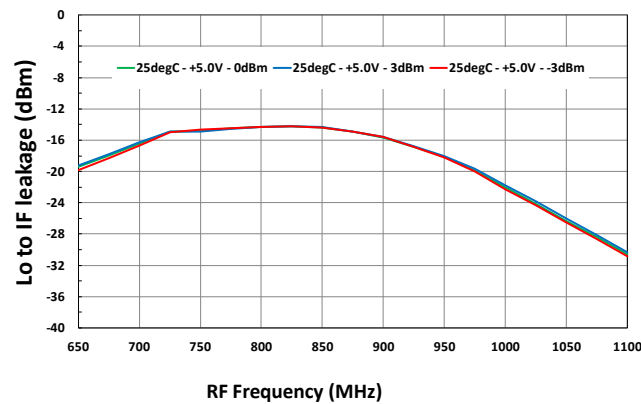

Lo to IF leakage vs. Vcc

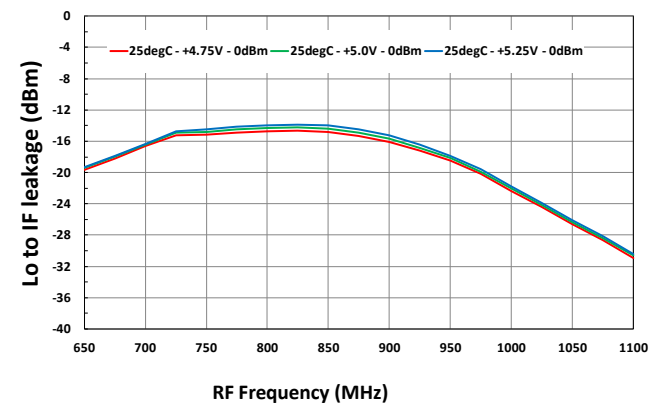

TOCs [IF = 200MHz, Low Side Injection] RF to IF leakage, OIP3, H2 (10)

RF to IF leakage vs. T_{CASE}

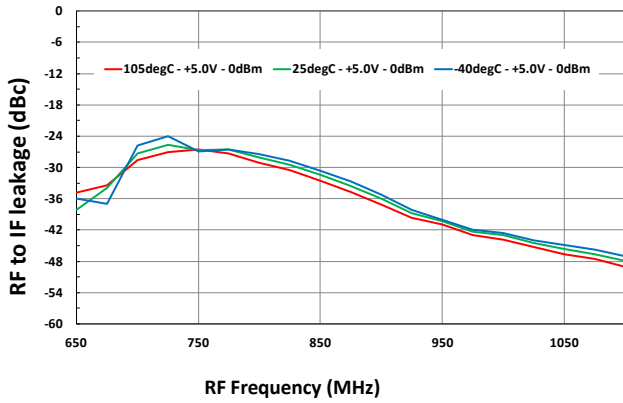

RF to IF leakage vs. Lo Level

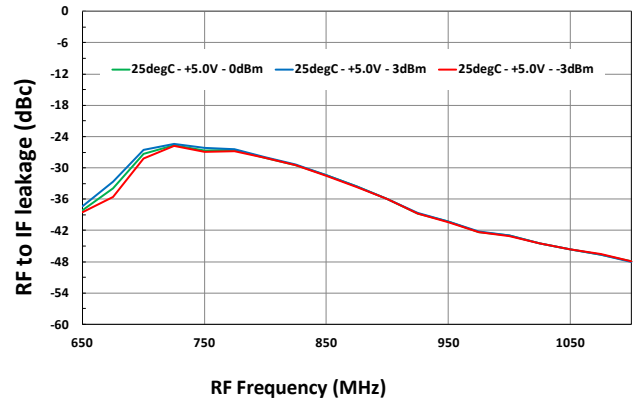

RF to IF leakage vs. V_{CC}

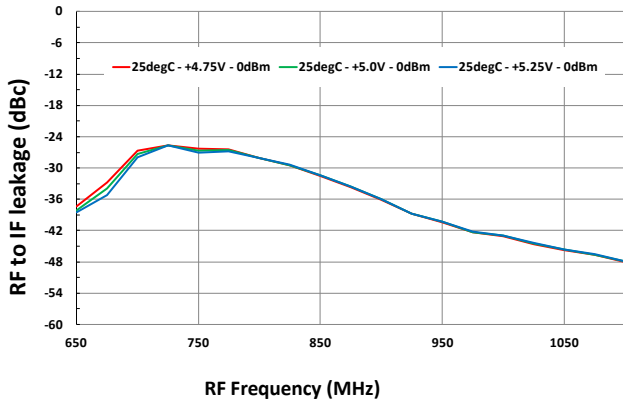

OIP3 vs. Input power

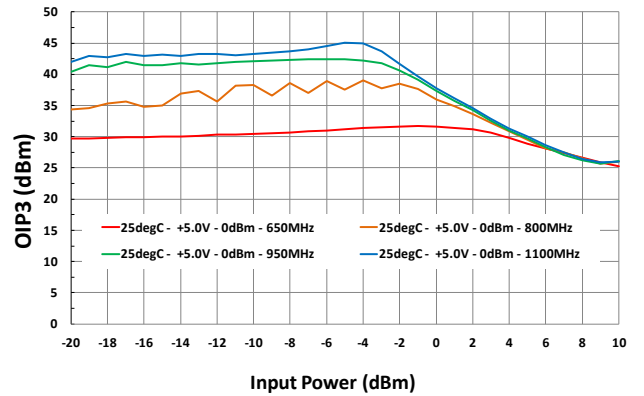

HD2 vs. Input power

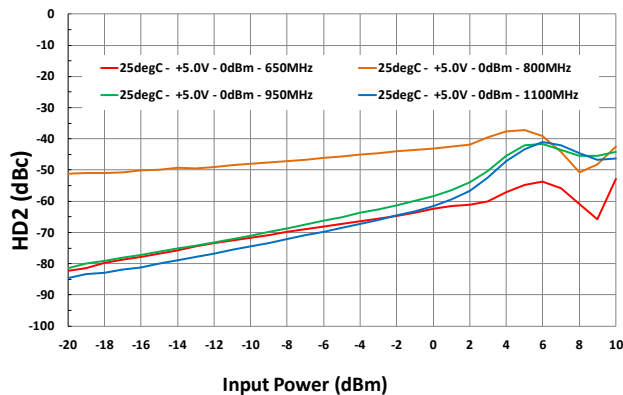

OIP3 vs. Delta Frequency of two tones

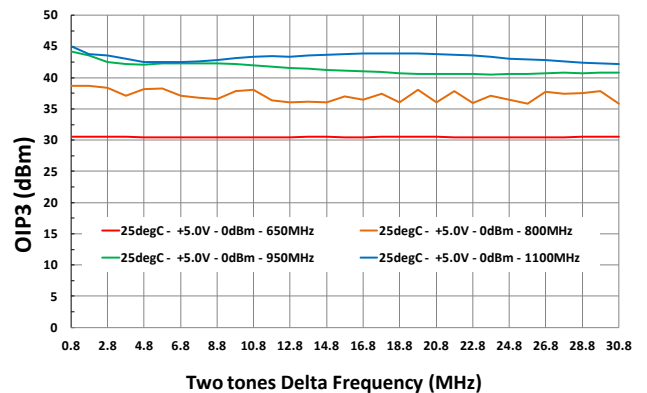

TOCs NF, Settling Time, Return Loss (11)

Noise Figure vs. T_{CASE}

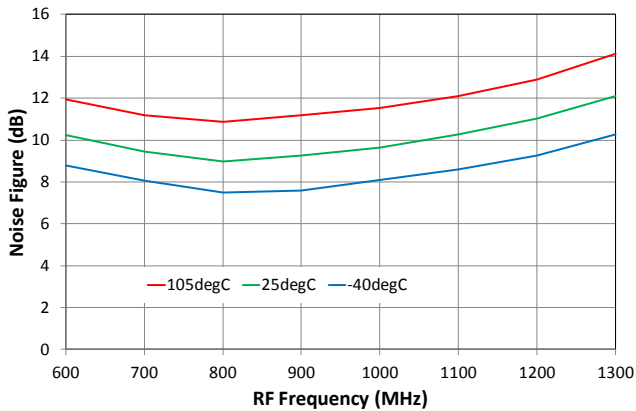

Noise Figure with Blocker (RF: 950MHz, Blocker: 850MHz)

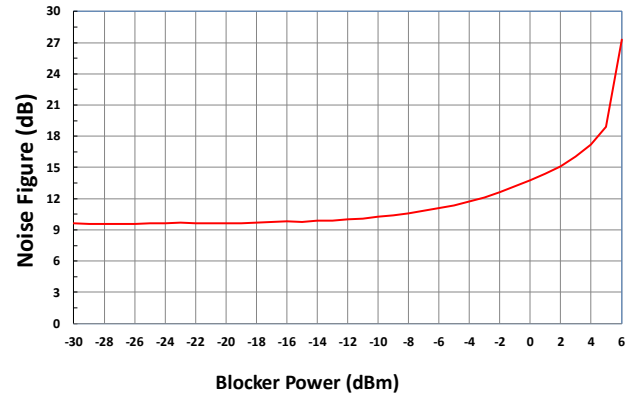

Turn on Settling

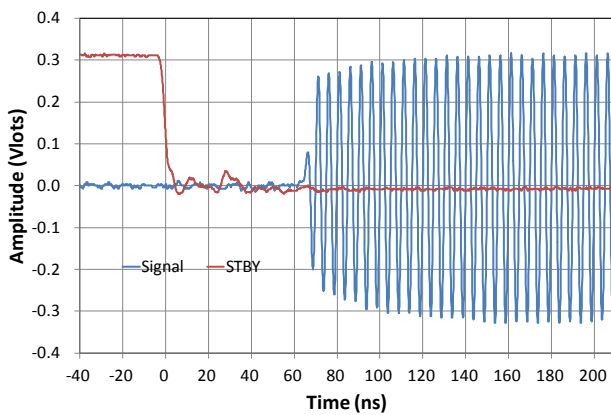

Turn off Settling

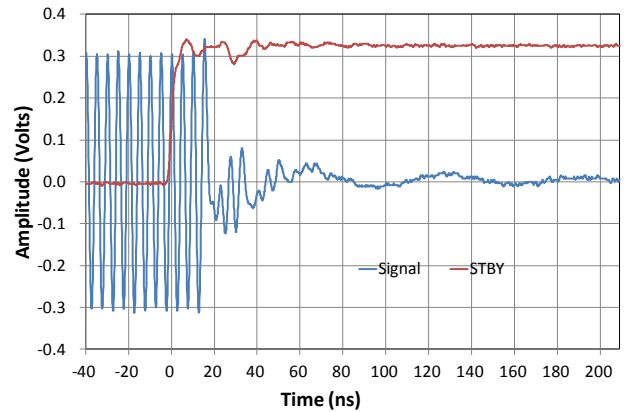

Lo port Return Loss

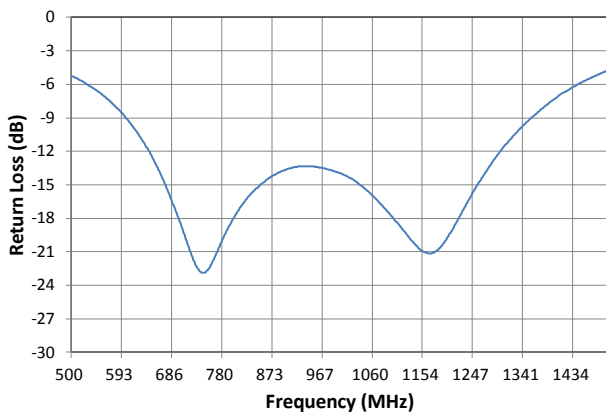

RF port Return Loss

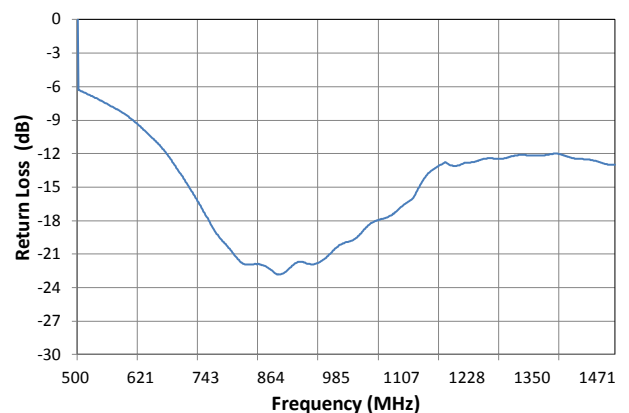



RF to IF Single Downconverting Mixer

600MHz to 1060MHz

TOCs Return Loss (12)

IF port Return Loss

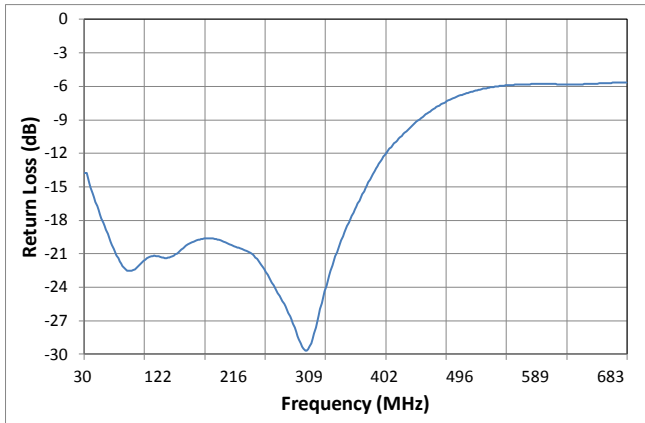



IDTF1701NBGI Datasheet

RF to IF Single Downconverting Mixer

600MHz to 1060MHz

PACKAGE DRAWING (NBG20)

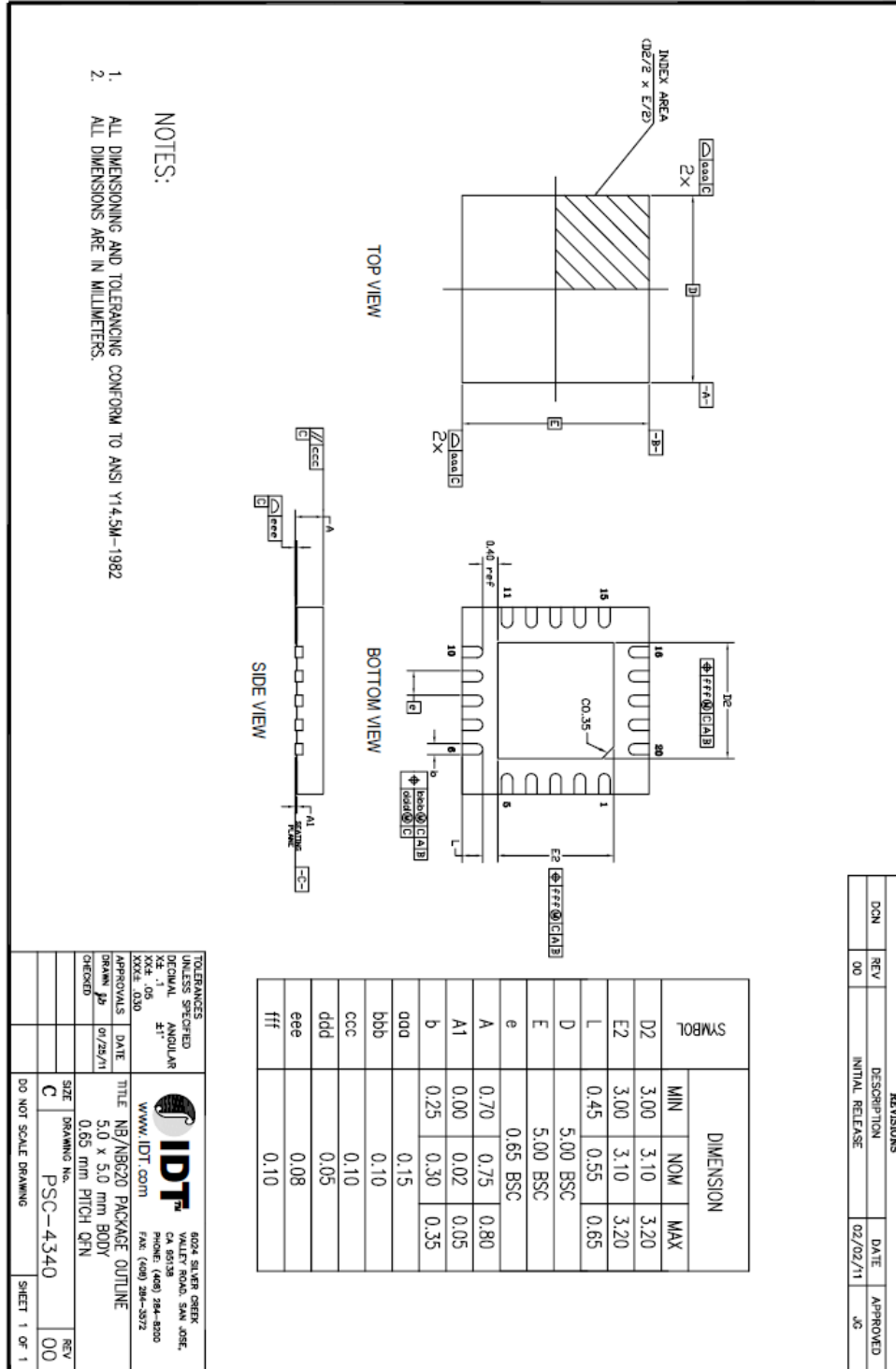

PIN DIAGRAM

BLACK TEXT is recommended external connection
RED TEXT denotes internal function or connection

TOP View

(looking through the top of the package)

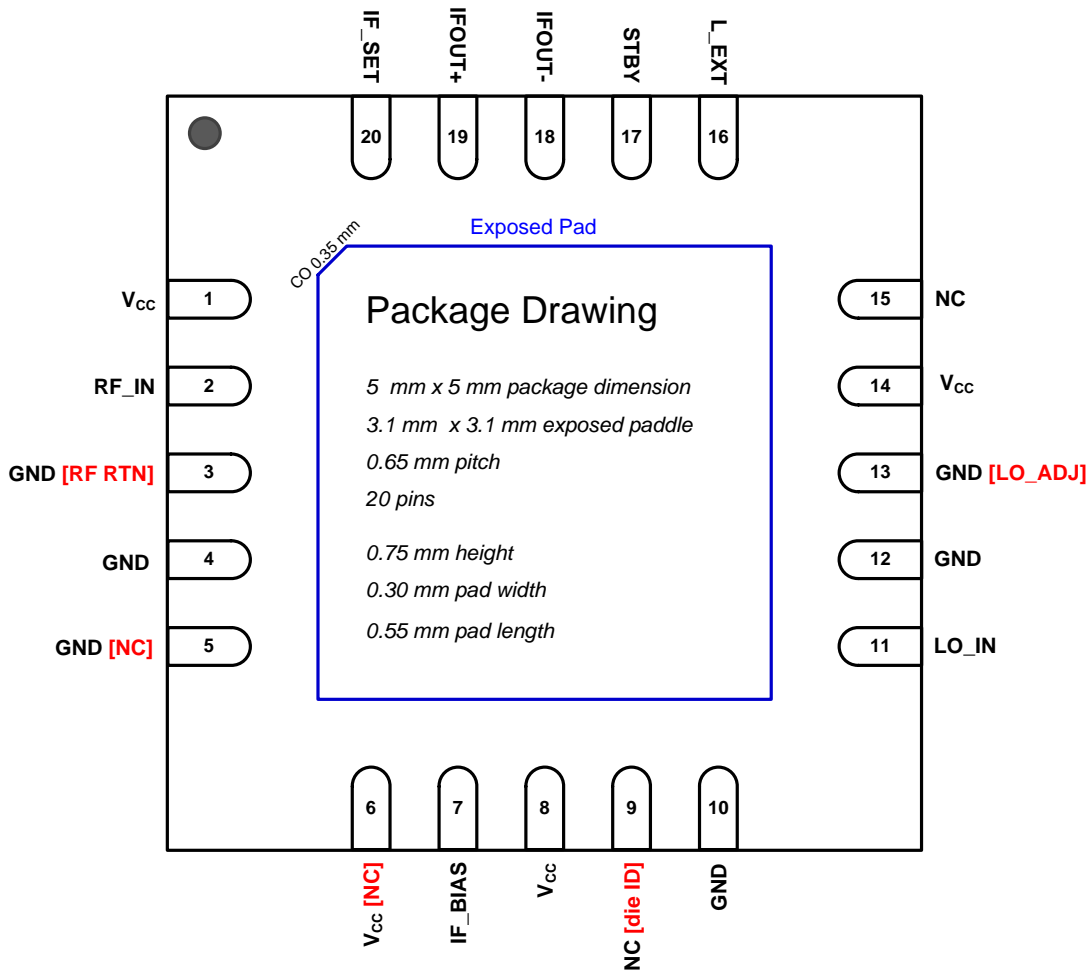



PIN DESCRIPTIONS

| Pin | Name | Function |
|-----|--------------|--|
| 1 | VCC | Power Supply. Bypass to GND with capacitors shown in the Typical Application Circuit as close as possible to pin. |
| 2 | RF_IN | RF Input. Internally matched to 50Ω. Do not apply DC to this pin. |
| 3 | GND [RF_RTN] | RF input Balun return. Ground this pin |
| 4 | GND | Internally bonded to GND |
| 5 | GND [NC] | No Connection. Not internally connected. OK to connect to VCC. OK to connect to GND. |
| 6 | VCC [NC] | No Connection. Not internally connected. OK to connect to VCC. OK to connect to GND. |
| 7 | IF_BIAS | Connect the specified resistor from this pin to ground to optimize linearity. |
| 8 | VCC | Power Supply. Bypass to GND with capacitors shown in the Typical Application Circuit as close as possible to pin. |
| 9 | NC [die ID] | This pin serves as the die ID. Leave it unconnected |
| 10 | GND | Internally bonded to GND |
| 11 | LO_IN | Local Oscillator Input. This input is internally matched to 50Ω. This pin requires an input DC-blocking capacitor |
| 12 | GND | Internally bonded to GND |
| 13 | GND [LO_ADJ] | Ground this pin for best linearity performance. A resistor from this pin to GND can be used to reduce DC power consumption while slightly degrading linearity performance. |
| 14 | VCC | Power Supply. Bypass to GND with capacitors shown in the Typical Application Circuit as close as possible to pin. |
| 15 | NC | No Connection. Not internally connected. OK to connect to VCC. OK to connect to GND. |
| 16 | L_EXT | Connect an external inductor to GND to optimize LO-IF leakage performance. |
| 17 | STBY | Ground for normal operation. Pull high to disable |
| 18 | IF_OUT- | Mixer Differential IF Output. Connect pullup inductor from this pin to VCC (see the Typical Application Circuit). |
| 19 | IF_OUT+ | Mixer Differential IF Output. Connect pullup inductor from this pin to VCC (see the Typical Application Circuit). |
| 20 | IF_SET | Connect the specified resistor from this pin to ground to set the correct Icc for the IF amplifier. |
| | — EP | Exposed Pad. Internally connected to GND. Connect to Ground with multiple vias for good thermal relief |

EVKIT / APPLICATION CIRCUIT

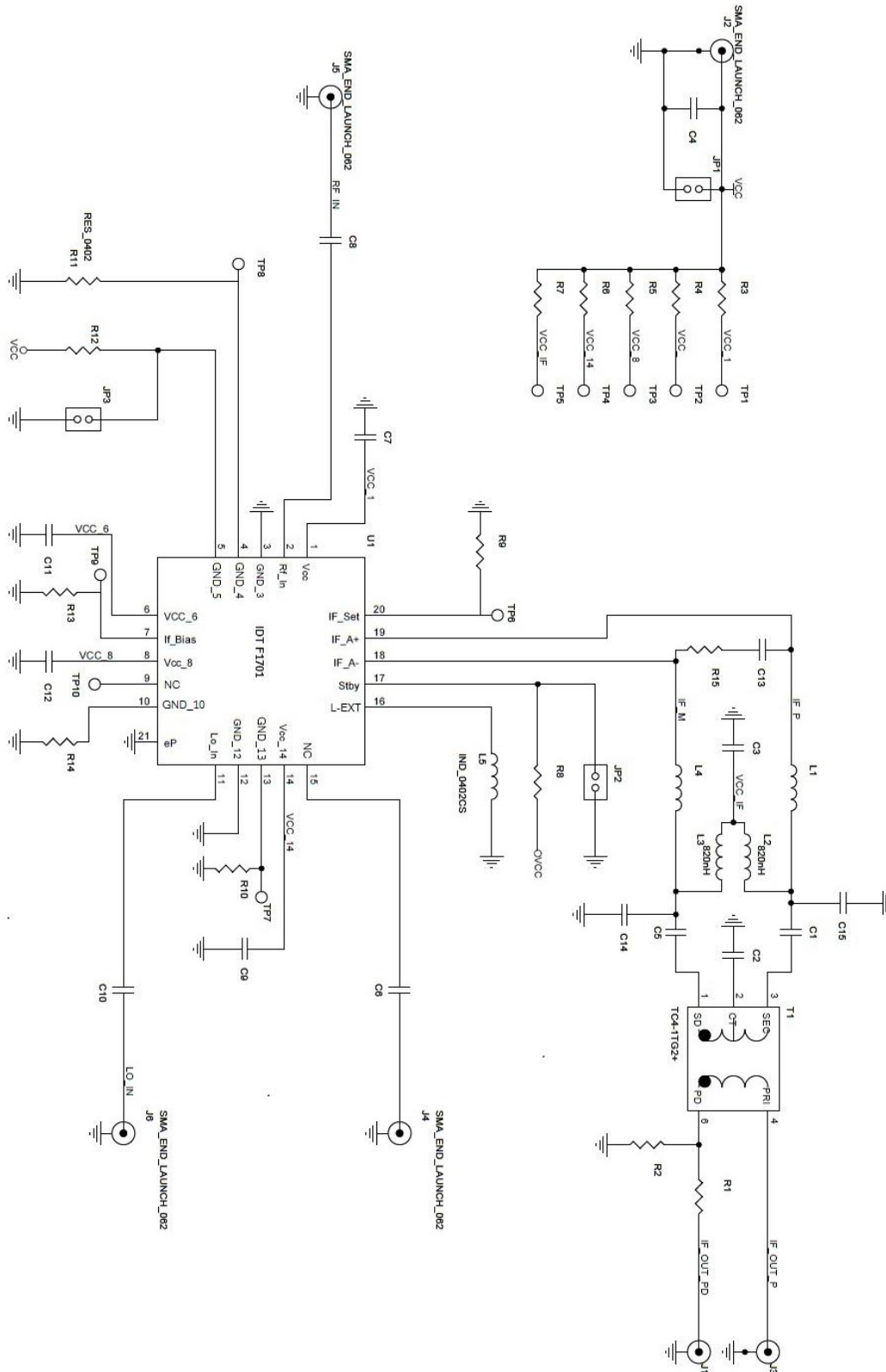

POWER SUPPLIES

All supply pins should be bypassed with external capacitors to minimize noise and fast transients. Supply noise can degrade noise figure and fast transients can trigger ESD clamps and cause them to fail. Supply voltage change or transients should have a slew rate smaller than 1V/20uS. In addition, all control pins should remain at 0V (+/-0.3V) while the supply voltage ramps or while it returns to zero.

EVKIT PICTURE/LAYOUT/OPERATION

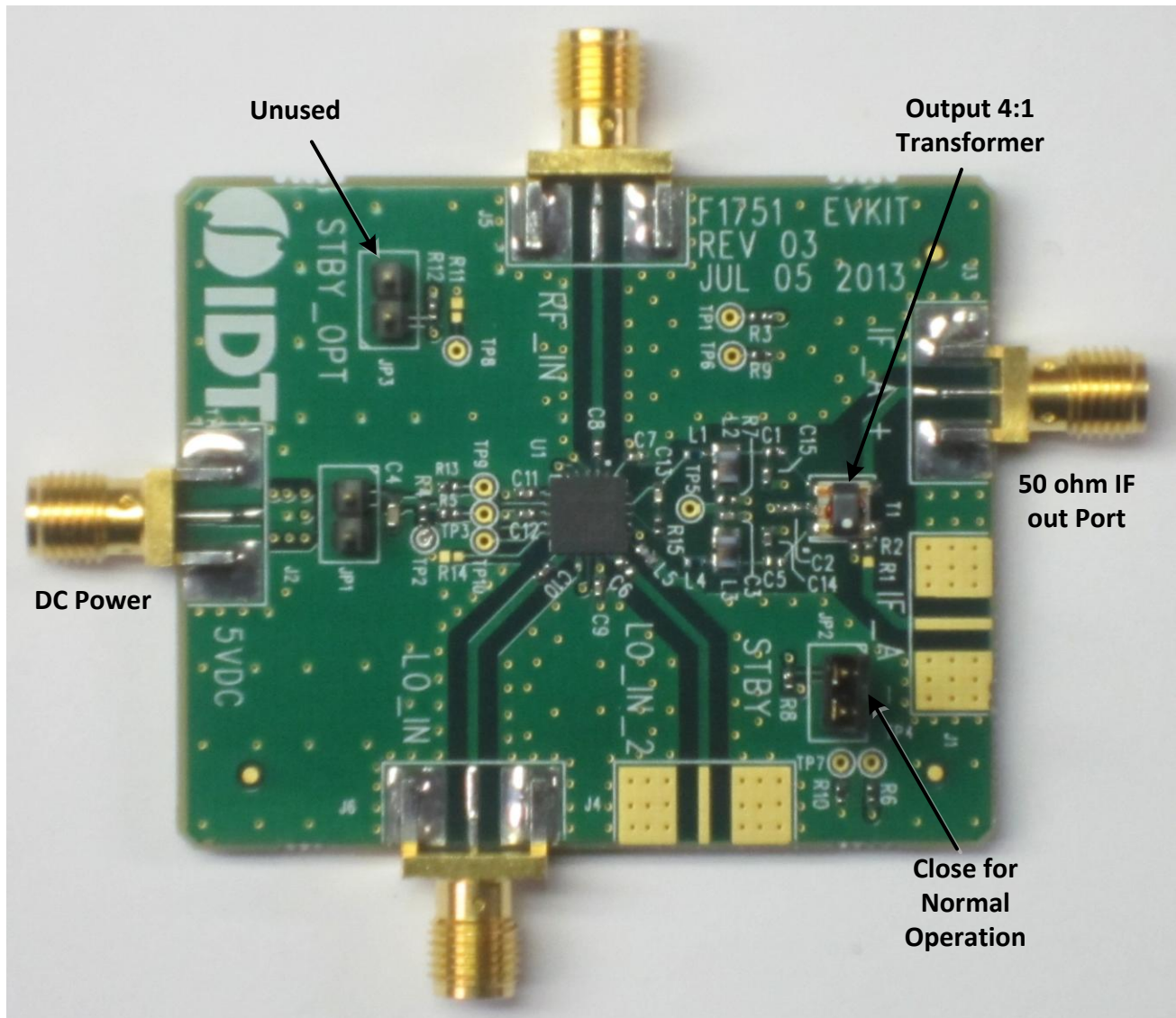

RF to IF Single Downconverting Mixer

600MHz to 1060MHz

EVKIT BOM

F1701
11/26/2013

| Item # | Value | Size/Rev | Desc | Mfr. Part # | Mfr. | Supplier Part # | Supplier | Part Reference | Qty |
|--------------|----------------|----------|---|---------------------|-----------------|-------------------|---------------|-----------------------------|-----------|
| 1 | 10nF | 0402 | CAP CER 10000PF 16V 10% X7R 0402 | GRM155R71C103KA01D | MURATA | 490-1313-1-ND | Digikey | C2,3,7,9,12 | 5 |
| 2 | 10uF | 0603 | CAP CER 10UF 6.3V X5R 0603 | GRM188R60J106ME47D | MURATA | 490-3896-1-ND | Digikey | C4 | 1 |
| 3 | 0.5pF | 0402 | CAP CER 0.5PF 50V NP0 0402 | GJM1555C1HR50BB01D | MURATA | 490-6077-1-ND | Digikey | C13 | 1 |
| 4 | 3pF | 0402 | CAP CER 3PF 50V C0G 0402 | GRM1555C1H3R0CZ01D | MURATA | 490-3205-1-ND | Digikey | C14,15 | 2 |
| 5 | 39pF | 0402 | CAP CER 39PF 50V 5% C0G 0402 | GRM1555C1H390JZ010 | MURATA | 490-1286-1-ND | Digikey | C8,10 | 2 |
| 6 | 0 | 0402 | RES 0.0 OHM 1/10W 0402 SMD | ERJ-2GE0R00X | Panasonic | P0.0JCT-ND | Digikey | R2,3,4,5,6,7,10,11,14,C1,C5 | 11 |
| 7 | 100 | 0402 | RES 100 OHM 1/10W 1% 0402 SMD | ERJ-2RKF1000X | Panasonic | P100LCT-ND | Digikey | R15 | 1 |
| 8 | 806 | 0402 | RES 806 OHM 1/10W 1% 0402 SMD | ERJ-2RKF8060X | Panasonic | P806LCT-ND | Digikey | R9 | 1 |
| 9 | 6.19K | 0402 | RES 6.19K OHM 1/10W 1% 0402 SMD | ERJ-2RKF6191X | Panasonic | P6.19KLCCT-ND | Digikey | R13 | 1 |
| 10 | 47K | 0402 | RES 47.0K OHM 1/16W 1% 0402 SMD | RC0402FR-0747KL | Yageo | 311-47.0KLRCT-ND | Digikey | R8 | 1 |
| 11 | 36nH | 0402 | 0402 Inductor 36nH LQW series | LQW15AN36NJ00D | MURATA | LQW15AN36NJ00D-ND | Digikey | L1,4 | 2 |
| 12 | 820nH | 0805 | 0805CS (2012) Ceramic Chip Inductor | 0805CS-821XJLB | COILCRAFT | 0805CS-821XJLB | COILCRAFT | L2,3 | 2 |
| 13 | 10nH | 402 | 0402CS Ceramic Chip Inductor | 0402CS-10NXJLU | COILCRAFT | 0402CS-10NXJLU | COILCRAFT | L5 | 1 |
| 14 | Header_2Pin | TH_2 | CONN HEADER VERT SGL 2POS GOLD | 961102-6404-AR | 3M | 3M9447-ND | Digikey | JP1,2,3 | 3 |
| 15 | SMA_END_LAUNCH | .062 | CONN SMA JACK END LAUNCH PCB (Big) | 142-0701-851 | Emerson Johnson | 530-142-0701-851 | Mouser | J5,6 | 2 |
| 16 | SMA_END_LAUNCH | .062 | CONN SMA JACK END LAUNCH PCB (Small) | 142-0711-821 | Emerson Johnson | 530-142-0711-821 | Mouser | J2,3 | 2 |
| 17 | 4:1 Balun | SM-22 | 4:1 Center Tap Balun 50 OHM 3 TO 800Mhz | TC4-6TG2+ | Mini Circuits | TC4-6TG2+ | Mini Circuits | T1 | 1 |
| 18 | F1701 | QFN-24 | IF MIXER NBG24 | F1701 | IDT | F1701-014 | | U1 | 1 |
| 19 | PCB | 03 | Printed Circuit Board | F1751 EV Kit Rev 03 | | | | | 1 |
| 20 | BOM | 01 | Bill Of Material | | | | | | |
| 21 | DNP | 402 | | | | | | R1,12,C6,11,JP3 | |
| Total | | | | | | | | | 41 |

TOP MARKINGS

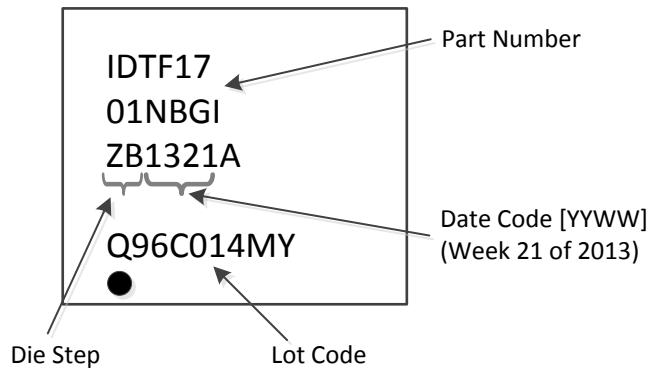

Компания «Life Electronics» занимается поставками электронных компонентов импортного и отечественного производства от производителей и со складов крупных дистрибьюторов Европы, Америки и Азии.

С конца 2013 года компания активно расширяет линейку поставок компонентов по направлению коаксиальный кабель, кварцевые генераторы и конденсаторы (керамические, пленочные, электролитические), за счёт заключения дистрибьюторских договоров

Мы предлагаем:

- Конкурентоспособные цены и скидки постоянным клиентам.
- Специальные условия для постоянных клиентов.
- Подбор аналогов.
- Поставку компонентов в любых объемах, удовлетворяющих вашим потребностям.
- Приемлемые сроки поставки, возможна ускоренная поставка.
- Доставку товара в любую точку России и стран СНГ.
- Комплексную поставку.
- Работу по проектам и поставку образцов.
- Формирование склада под заказчика.
- Сертификаты соответствия на поставляемую продукцию (по желанию клиента).
- Тестирование поставляемой продукции.
- Поставку компонентов, требующих военную и космическую приемку.
- Входной контроль качества.
- Наличие сертификата ISO.

В составе нашей компании организован Конструкторский отдел, призванный помогать разработчикам, и инженерам.

Конструкторский отдел помогает осуществить:

- Регистрацию проекта у производителя компонентов.
- Техническую поддержку проекта.
- Защиту от снятия компонента с производства.
- Оценку стоимости проекта по компонентам.
- Изготовление тестовой платы монтаж и пусконаладочные работы.



Тел: +7 (812) 336 43 04 (многоканальный)

Email: org@lifeelectronics.ru