

NSD16F3T5G

Switching Diode

The NSD16F3T5G device is a spin-off of our popular SOT-23 three-leaded device. It is designed for switching applications and is housed in the SOT-1123 surface mount package. This device is ideal for low-power surface mount applications where board space is at a premium.

Features

- Reduces Board Space
- This is a Halide-Free Device
- This is a Pb-Free Device

MAXIMUM RATINGS

Rating	Symbol	Value	Unit
Reverse Voltage	V_R	75	Vdc
Forward Current	I_F	200	mAdc
Peak Forward Surge Current	$I_{FM(surge)}$	500	mAdc

THERMAL CHARACTERISTICS

Characteristic	Symbol	Max	Unit
Total Device Dissipation, $T_A = 25^\circ\text{C}$ Derate above 25°C	P_D (Note 1)	290 2.3	mW mW/ $^\circ\text{C}$
Thermal Resistance, Junction-to-Ambient	$R_{\theta JA}$ (Note 1)	432	$^\circ\text{C}/\text{W}$
Total Device Dissipation, $T_A = 25^\circ\text{C}$ Derate above 25°C	P_D (Note 2)	347 2.8	mW mW/ $^\circ\text{C}$
Thermal Resistance, Junction-to-Ambient	$R_{\theta JA}$ (Note 2)	360	$^\circ\text{C}/\text{W}$
Thermal Resistance, Junction-to-Lead 3	$R_{\psi JL}$ (Note 2)	143	$^\circ\text{C}/\text{W}$
Junction and Storage Temperature Range	T_J, T_{stg}	-55 to +150	$^\circ\text{C}$

Stresses exceeding Maximum Ratings may damage the device. Maximum Ratings are stress ratings only. Functional operation above the Recommended Operating Conditions is not implied. Extended exposure to stresses above the Recommended Operating Conditions may affect device reliability.

1. 100 mm² 1 oz, copper traces.
2. 500 mm² 1 oz, copper traces.



ON Semiconductor®

<http://onsemi.com>

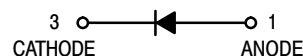

NSD16F3T5G

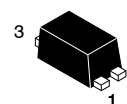

SOT-1123
CASE 524AA
STYLE 2

MARKING DIAGRAM



T = Device Code
M = Date Code

ORDERING INFORMATION

Device	Package	Shipping†
NSD16F3T5G	SOT-1123 (Pb-Free)	8000/Tape & Reel

†For information on tape and reel specifications, including part orientation and tape sizes, please refer to our Tape and Reel Packaging Specifications Brochure, BRD8011/D.

NSD16F3T5G

ELECTRICAL CHARACTERISTICS ($T_A = 25^\circ\text{C}$ unless otherwise noted)

Characteristic	Symbol	Min	Max	Unit
OFF CHARACTERISTICS				
Reverse Voltage Leakage Current ($V_R = 75\text{ Vdc}$) ($V_R = 75\text{ Vdc}, T_J = 150^\circ\text{C}$) ($V_R = 25\text{ Vdc}, T_J = 150^\circ\text{C}$)	I_R	-	1.0 50 30	μAdc
Reverse Breakdown Voltage ($I_{BR} = 100\ \mu\text{Adc}$)	$V_{(BR)}$	75	-	Vdc
Forward Voltage ($I_F = 1.0\ \text{mAdc}$) ($I_F = 10\ \text{mAdc}$) ($I_F = 50\ \text{mAdc}$) ($I_F = 150\ \text{mAdc}$)	V_F	-	715 855 1000 1250	mV
Diode Capacitance ($V_R = 0, f = 1.0\ \text{MHz}$)	C_D	-	2.0	pF
Forward Recovery Voltage ($I_F = 10\ \text{mAdc}, t_r = 20\ \text{ns}$)	V_{FR}	-	1.75	Vdc
Reverse Recovery Time ($I_F = I_R = 10\ \text{mAdc}, R_L = 50\ \Omega$)	t_{rr}	-	6.0	ns
Stored Charge ($I_F = 10\ \text{mAdc}$ to $V_R = 5.0\ \text{Vdc}, R_L = 500\ \Omega$)	Q_S	-	45	pC

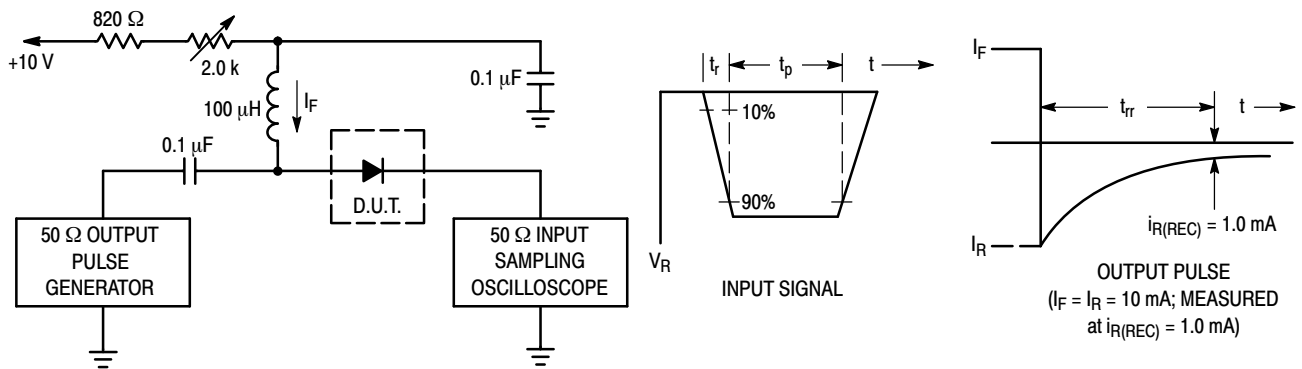

- Notes: 1. A 2.0 k Ω variable resistor adjusted for a Forward Current (I_F) of 10 mA.
 2. Input pulse is adjusted so $I_{R(\text{peak})}$ is equal to 10 mA.
 3. $t_p \gg t_{rr}$

Figure 1. Recovery Time Equivalent Test Circuit

NSD16F3T5G

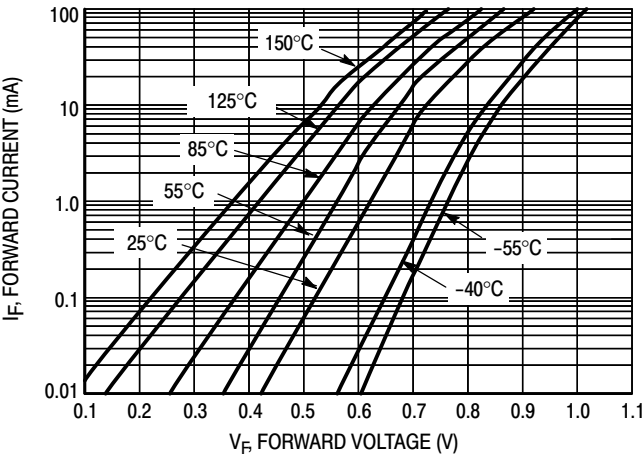

Figure 2. V_F vs. I_F

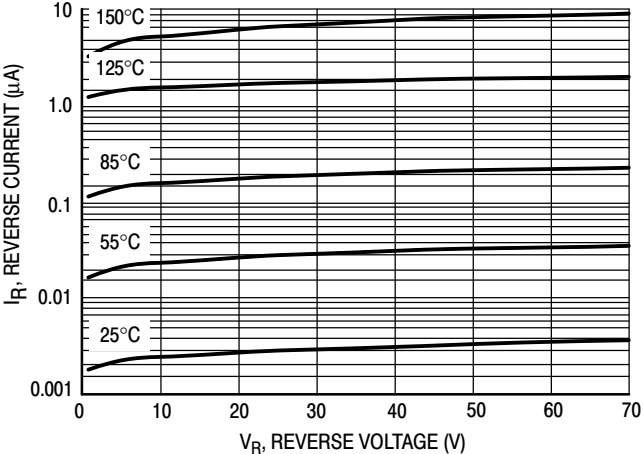

Figure 3. I_R vs. V_R

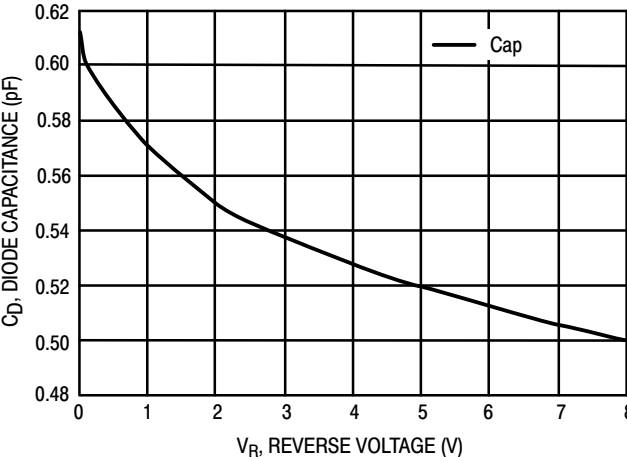
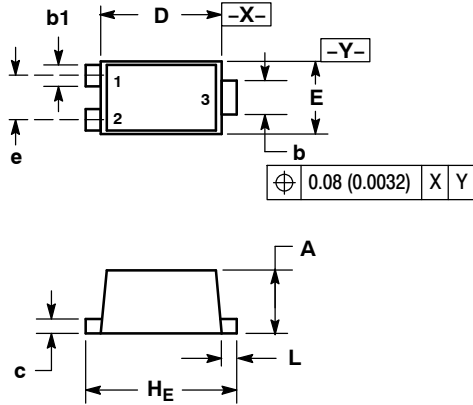

Figure 4. Capacitance

NSD16F3T5G

PACKAGE DIMENSIONS

SOT-1123
CASE 524AA-01
ISSUE A



- NOTES:
1. DIMENSIONING AND TOLERANCING PER ANSI Y14.5M, 1982.
 2. CONTROLLING DIMENSION: MILLIMETERS.
 3. MAXIMUM LEAD THICKNESS INCLUDES LEAD FINISH THICKNESS. MINIMUM LEAD THICKNESS IS THE MINIMUM THICKNESS OF BASE MATERIAL.

DIM	MILLIMETERS			INCHES		
	MIN	NOM	MAX	MIN	NOM	MAX
A	0.34	0.37	0.40	0.013	0.015	0.016
b	0.15	0.20	0.25	0.006	0.008	0.010
b1	0.10	0.15	0.20	0.004	0.006	0.008
c	0.07	0.12	0.17	0.003	0.005	0.007
D	0.75	0.80	0.85	0.030	0.031	0.033
E	0.55	0.60	0.65	0.022	0.024	0.026
e	0.35			0.014		
HE	0.95	1.00	1.05	0.037	0.039	0.041
L	0.05	0.10	0.15	0.002	0.004	0.006

STYLE 2:
PIN 1. ANODE
2. N/C
3. CATHODE

SOLDERING FOOTPRINT*

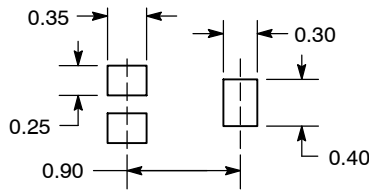

DIMENSIONS: MILLIMETERS

*For additional information on our Pb-Free strategy and soldering details, please download the ON Semiconductor Soldering and Mounting Techniques Reference Manual, SOLDERRM/D.

ON Semiconductor and are registered trademarks of Semiconductor Components Industries, LLC (SCILLC). SCILLC reserves the right to make changes without further notice to any products herein. SCILLC makes no warranty, representation or guarantee regarding the suitability of its products for any particular purpose, nor does SCILLC assume any liability arising out of the application or use of any product or circuit, and specifically disclaims any and all liability, including without limitation special, consequential or incidental damages. "Typical" parameters which may be provided in SCILLC data sheets and/or specifications can and do vary in different applications and actual performance may vary over time. All operating parameters, including "Typicals" must be validated for each customer application by customer's technical experts. SCILLC does not convey any license under its patent rights nor the rights of others. SCILLC products are not designed, intended, or authorized for use as components in systems intended for surgical implant into the body, or other applications intended to support or sustain life, or for any other application in which the failure of the SCILLC product could create a situation where personal injury or death may occur. Should Buyer purchase or use SCILLC products for any such unintended or unauthorized application, Buyer shall indemnify and hold SCILLC and its officers, employees, subsidiaries, affiliates, and distributors harmless against all claims, costs, damages, and expenses, and reasonable attorney fees arising out of, directly or indirectly, any claim of personal injury or death associated with such unintended or unauthorized use, even if such claim alleges that SCILLC was negligent regarding the design or manufacture of the part. SCILLC is an Equal Opportunity/Affirmative Action Employer. This literature is subject to all applicable copyright laws and is not for resale in any manner.

PUBLICATION ORDERING INFORMATION

LITERATURE FULFILLMENT:
Literature Distribution Center for ON Semiconductor
P.O. Box 5163, Denver, Colorado 80217 USA
Phone: 303-675-2175 or 800-344-3860 Toll Free USA/Canada
Fax: 303-675-2176 or 800-344-3867 Toll Free USA/Canada
Email: orderlit@onsemi.com

N. American Technical Support: 800-282-9855 Toll Free
USA/Canada
Europe, Middle East and Africa Technical Support:
Phone: 421 33 790 2910
Japan Customer Focus Center
Phone: 81-3-5773-3850

ON Semiconductor Website: www.onsemi.com

Order Literature: <http://www.onsemi.com/orderlit>

For additional information, please contact your local Sales Representative

Компания «Life Electronics» занимается поставками электронных компонентов импортного и отечественного производства от производителей и со складов крупных дистрибьюторов Европы, Америки и Азии.

С конца 2013 года компания активно расширяет линейку поставок компонентов по направлению коаксиальный кабель, кварцевые генераторы и конденсаторы (керамические, пленочные, электролитические), за счёт заключения дистрибьюторских договоров

Мы предлагаем:

- Конкурентоспособные цены и скидки постоянным клиентам.
- Специальные условия для постоянных клиентов.
- Подбор аналогов.
- Поставку компонентов в любых объемах, удовлетворяющих вашим потребностям.
- Приемлемые сроки поставки, возможна ускоренная поставка.
- Доставку товара в любую точку России и стран СНГ.
- Комплексную поставку.
- Работу по проектам и поставку образцов.
- Формирование склада под заказчика.
- Сертификаты соответствия на поставляемую продукцию (по желанию клиента).
- Тестирование поставляемой продукции.
- Поставку компонентов, требующих военную и космическую приемку.
- Входной контроль качества.
- Наличие сертификата ISO.

В составе нашей компании организован Конструкторский отдел, призванный помогать разработчикам, и инженерам.

Конструкторский отдел помогает осуществить:

- Регистрацию проекта у производителя компонентов.
- Техническую поддержку проекта.
- Защиту от снятия компонента с производства.
- Оценку стоимости проекта по компонентам.
- Изготовление тестовой платы монтаж и пусконаладочные работы.



Тел: +7 (812) 336 43 04 (многоканальный)

Email: org@lifeelectronics.ru