

Ultra-low Power Real Time Clock Module with I²C Bus

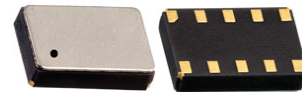

3.7 x 2.5 x 0.9 mm

AB-RTCMC-32.768kHz-IBO5-S3



RoHS/RoHS II compliant

Moisture Sensitivity Level: MSL=1

FEATURES:

- Based on state-of-the-art RTC Technology by Micro Crystal AG
- Ultra-Low current consumption:
 - XTAL Mode 60nA typ. @3.0V
 - RC Mode 17nA typ. @3.0V
 - RC Autocalibrated Mode 22nA typ. @3.0V
- RTC module with built-in crystal oscillating at 32.768 kHz
- Operating voltage: 1.5 – 3.6V
- Operating temperature range: -40 to +85°C
- Factory calibrated Time accuracy ±2.0ppm typ. @ 25°C
- Automatic Battery Switchover
- Trickle Charger, Power Management & Power Switch Function
- Programmable CLKOUT frequencies
- I²C Bus Interface (fast mode 400kHz)
- Time keeping mode down to 1.5 V
- Programmable Alarm, Timer and INT
- Up to 512 Bytes of general purpose RAM
- Small and compact package size: 3.7 x 2.5 x 0.9 mm. RoHS-compliant and 100% lead free

APPLICATIONS:

- Smart cards
- Wireless sensors and tags
- Medical/Healthcare electronics
- Sports and fitness electronics
- Smart Utility meters
- Data loggers
- Appliances
- Tracking systems
- Home security systems
- Industrial and Consumer electronics
- Communications equipment

STANDARD SPECIFICATIONS:

Absolute Maximum Ratings

Parameters		Min.	Typ.	Max.	Units	Notes
Power Supply Voltage (V _{DD})		-0.3		3.8	V	
Backup Supply voltage (V _{BACKUP})		-0.3		3.8	V	
Input Voltage (V _I)	V _{DD} Power state	-0.3		V _{DD} + 0.3	V	
	V _{BACKUP} Power State	-0.3		V _{BACUUP} + 0.3	V	
Output Voltage (V _O)	V _{DD} Power state	-0.3		V _{DD} + 0.3	V	
	V _{BACKUP} Power State	-0.3		V _{BACUUP} + 0.3	V	
Input Current (I _I)		-10		10	mA	
Output Current (I _O)		-20		20	mA	
PSW Output Continuous Current (I _{OPC})				50	mA	
PSW Output Pulsed Current (I _{OPP})				150	mA	1 second pulse
ESD Voltage (V _{ESD})	CDM			±500	V	Charged Device Model
	HBM			±4000	V	Human Body Model
Latch-up Current (I _{LU})				100	mA	
Operating Temperature Range (T _{OP})		-40		+85	°C	
Storage Temperature (T _{STG})		-55		+125	°C	Stored as bare product
Lead Temperature (T _{SLD})				+300	°C	Hand soldering for 10s
Reflow Soldering Temperature (T _{REF})				+260	°C	Reflow profile per JEDEC J-STD-020D

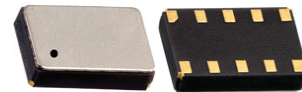

Power Supply and Switchover Parameters

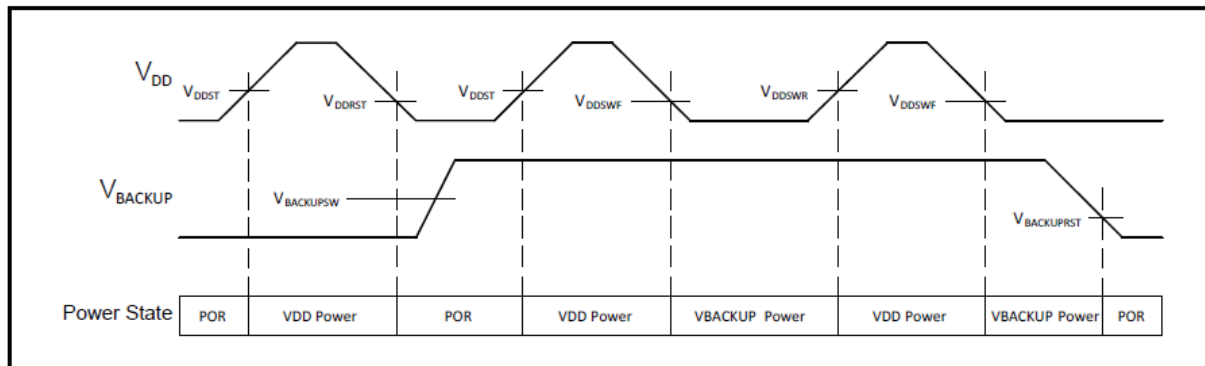

T_A = -40 to +85°C, Typ. values at +25°C

Parameters	Type	Power State	Test Conditions	Min.	Typ.	Max.	Units
System Power Voltage (V _{DD})	Static	V _{DD} Power	Clocks operating and RAM and registers retained	1.5		3.6	V
V _{DD} I ² C Interface Voltage (V _{DDIO})	Static	V _{DD} Power	I ² C operation	1.5		3.6	V
V _{DD} Start-up Voltage (V _{DDST}) ⁽¹⁾	Rising	POR->V _{DD} Power		1.6			V
V _{DD} Reset Voltage (V _{DDRST})	Falling	V _{DD} Power -> POR	V _{BACKUP} < V _{BACKUP, MIN} or no V _{BACKUP}		1.3	1.5	V
V _{DD} Rising Switchover Threshold Voltage (V _{DDSWR})	Rising	V _{BACKUP} Power ->V _{DD} Power	V _{BACKUP} ≥ V _{BACKRST}		1.6	1.7	V
V _{DD} Falling Switchover Threshold Voltage (V _{DDSWF})	Falling	V _{DD} Power -> V _{BACKUP} Power	V _{BACKUP} ≥ V _{BACKSW, MIN}	1.2	1.5		V
V _{DD} Switchover Threshold Hysteresis (V _{DDSWH}) ⁽²⁾	Hyst.	V _{DD} Power <-> V _{BACKUP} Power			70		mV
V _{DD} Falling Slew Rate to Switch to V _{BACKUP} State (V _{DDFS}) ⁽⁴⁾	Falling	V _{DD} Power -> V _{BACKUP} Power	V _{DD} < V _{DDSW, MAX}	0.7	1.4		V
Backup Voltage (V _{BACKUP})	Static	V _{BACKUP} Power	Clocks operating and RAM and registers retained	1.4		3.6	V
Backup Switchover Voltage Range (V _{BACKSW}) ⁽⁵⁾	Static	V _{DD} Power -> V _{BACKUP} Power		1.6		3.6	V
Falling Backup POR Voltage (V _{BACKRST}) ⁽⁷⁾	Falling	V _{BACKUP} Power -> POR	V _{DD} < V _{DDSWF}		1.1	1.4	V
V _{BACK} Margin above V _{DD} (V _{BMRG}) ⁽³⁾	Static	V _{BACKUP} Power		200			mV
V _{BACK} Supply Series Resistance (R _{BACKESR}) ⁽⁶⁾	Static	V _{BACKUP} Power		1.0	1.5		kΩ

Ultra-low Power Real Time Clock Module with I²C Bus

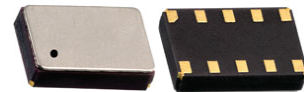

3.7 x 2.5 x 0.9 mm

AB-RTCMC-32.768kHz-IBO5-S3



RoHS/RoHS II compliant

- (1) V_{DD} must be above V_{DDST} to exit the POR state, independent of the V_{BACKUP} voltage.
- (2) Difference between V_{DDSWR} and V_{DDSWF} .
- (3) V_{BACKUP} must be higher than V_{DD} by at least this voltage to insure the AB-RTCMC-32.768kHz-IBO5-S3 remains in the V_{BACKUP} Power state.
- (4) Maximum V_{DD} falling slew rate to guarantee correct switchover to V_{BACKUP} Power state. There is no V_{DD} falling slew rate requirement if switching to the V_{BACKUP} power source is not required.
- (5) V_{BACKUP} voltage to guarantee correct transition to V_{BACKUP} Power state when V_{DD} falls.
- (6) Total series resistance of the power source attached to the V_{BACKUP} pin. The optimal value is 1.5 k Ω , which may require an external resistor. V_{BACKUP} power source ESR (Equivalent Series Resistance) + external resistor value = 1.5 k Ω .
- (7) $V_{BACKRST}$ is also the static voltage required on V_{BACKUP} for register data retention.

Operating Parameters

$T_A = -40$ to $+85^\circ\text{C}$, Typ. values at $+25^\circ\text{C}$

Parameters	Test Conditions	V_{DD}	Min.	Typ.	Max.	Units
Positive-going Input Threshold Voltage (V_{T+})		3.0V		1.5	2.0	V
		1.8V		1.1	1.25	
Negative-going Input Threshold Voltage (V_{T-})		3.0V	0.8	0.9		V
		1.8V	0.5	0.6		
Input Leakage Current (I_{LEAK})		3.0V		0.02	80	nA
Input Capacitance (C_I)				3		pF
PSW Output Resistance to V_{DD} (R_{DSON})	PSW enabled	1.7V		1.7	5.8	Ω
		1.8V		1.6	5.4	
		3.0V		1.1	3.8	
		3.6V		1.05	3.7	
Output Leakage Current (I_{OLEAK})		1.7V – 3.6V		0.02	80	nA

Oscillator Parameters

$T_A = -40$ to $+85^\circ\text{C}$ unless otherwise indicated. $V_{DD} = 1.7$ to 3.6V , Typ. values at $+25^\circ\text{C}$ and 3.0V

Parameters	Test Conditions	Min.	Typ.	Max.	Units
Crystal Frequency (F_{XT})			32.768		kHz
XT Oscillator Failure Detection Frequency (F_{OF})			8		kHz
Calibrated RC Oscillator Frequency (F_{RCC}) ⁽¹⁾	Factory calibrated at $+25^\circ\text{C}$, $V_{DD} = 2.8\text{V}$		64		Hz
Uncalibrated RC Oscillator Frequency (F_{RCU})	Calibration disabled (OFFSETR=0) – 128Hz level	89	122	200	Hz
Uncalibrated RC Oscillator Cycle-to-Cycle Jitter, Median (J_{RCCC})	Calibration disabled (OFFSETR=0) – 128Hz level		2000		ppm
	Calibration disabled (OFFSETR=0) – 1Hz level		500		
RC Oscillator Cycle-to-Cycle Jitter, MIN, MAX (J_{RCCC})	128Hz level at $+25^\circ\text{C}$	-1		1	%
	128Hz level -10 to $+70^\circ\text{C}$	-3.5		3.5	
	128Hz level -40 to $+85^\circ\text{C}$	-10		10	
XT Mode Digital Calibration Accuracy (A_{XT}) ⁽¹⁾	Calibrated at an initial temperature and voltage. Factory calibrated at $+25^\circ\text{C}$, $V_{DD} = 3.0\text{V}$	-2		+2	ppm

Ultra-low Power Real Time Clock Module with I²C Bus

AB-RTCMC-32.768kHz-IBO5-S3



RoHS/RoHS II compliant

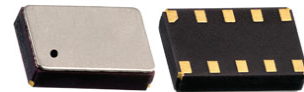

3.7 x 2.5 x 0.9 mm

(Continued)

T_A = -40 to +85°C unless otherwise indicated. V_{DD} = 1.7 to 3.6V, Typ. values at +25°C and 3.0V

Parameters	Test Conditions	Min.	Typ.	Max.	Units
Autocalibration Mode Timing Accuracy, 512 second period, T _A = -10 to +60°C (A _{AC}) ⁽¹⁾	24 hour run time		35		ppm
	1 week run time		20		
	1 month run time		10		
	1 year run time		3		
Autocalibration Mode Operating Temperature (T _{AC}) ⁽²⁾		-10		+60	°C

(1) Timing accuracy is specified at 25°C after digital calibration of the internal RC oscillator and digital calibration of the 32.768 kHz crystal. The 32.768 kHz tuning fork crystal has a negative temperature coefficient with a parabolic frequency deviation, which can result in a change of up to 150 ppm across the entire operating temperature range of -40°C to 85°C in XT mode. Autocalibration mode timing accuracy is specified relative to XT mode timing accuracy from -10°C to 60°C.

(2) Outside of this temperature range, the RC oscillator frequency change due to temperature may be outside of the allowable RC digital calibration range (+/-12%) for autocalibration mode. When this happens, an autocalibration failure will occur and the ACF interrupt flag is set. The AB-RTCMC-32.768kHz-IBO5-S3 should be switched to use the XT oscillator as its clock source when this occurs. Please see the AUTOCALIBRATION FAILURE section in the application manual for more details.

XT Frequency Characteristics

T_A = -40 to +85°C unless otherwise indicated. V_{DD} = 1.7 to 3.6V, Typ. values at +25°C and 3.0V, f_{OSC} = 32.768kHz

Parameters	Test Conditions	Min.	Typ.	Max.	Units
Frequency Accuracy (ΔF/F)	T _A = +25°C; Calibration disabled (OFFSETX=0)		±100 ⁽¹⁾		ppm
Frequency vs. Temperature Characteristics (ΔF/F ₀)	T _{OPR} = -40 to +85°C	-0.035 ^{ppm/°C} * (T _{OPR} -T ₀) ² ±10%			ppm
Turnover Temperature (T ₀)		+20	+25	+30	°C
Aging First Year	T _A = +25°C			±3	ppm
Oscillator Start-up Voltage	T _A = -40 to +85°C	1.6			V
Oscillator Start-up Time	V _{DD} = 1.7V – 3.6V		1.0		s
CLKOUT Duty Cycle	F _{CLKOUT} = 32.768kHz; T _A = +25°C	50	60	70	%

(1) The XT mode digital calibration accuracy is +/-2 ppm, see OSCILLATOR PARAMETERS.

Ultra-low Power Real Time Clock Module with I²C Bus

AB-RTCMC-32.768kHz-IBO5-S3



RoHS/RoHS II compliant

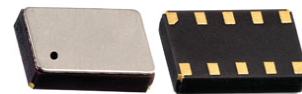

3.7 x 2.5 x 0.9 mm

XT Frequency vs. Temperature Characteristics

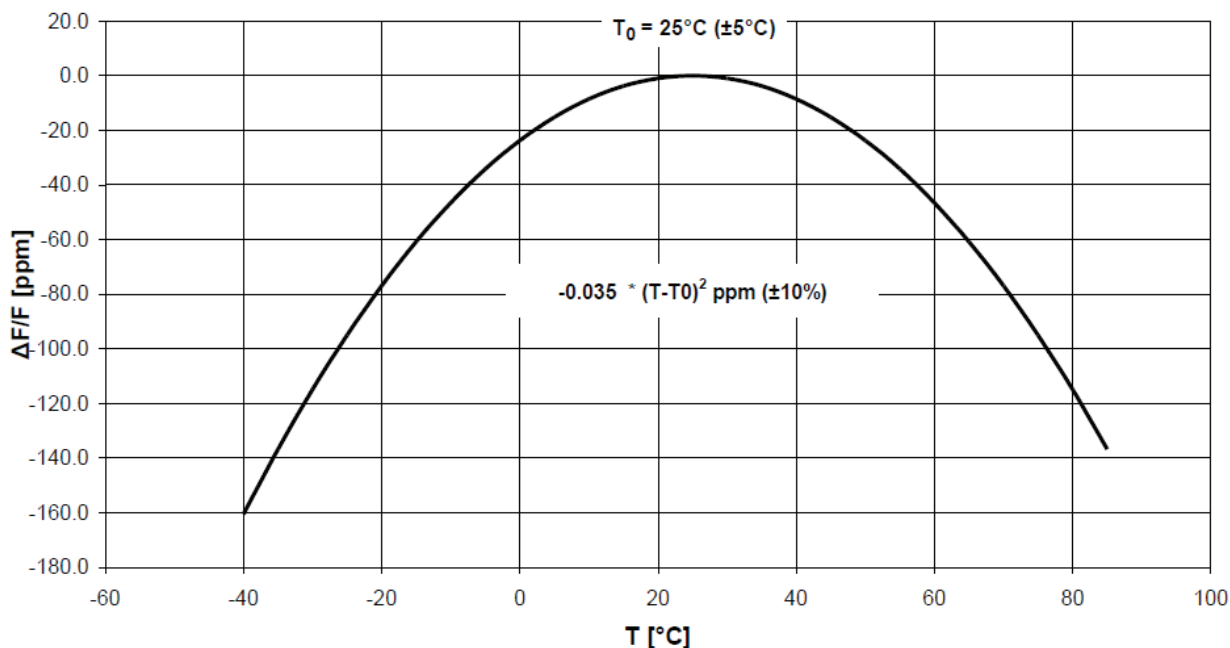

V_{DD} Supply Current

T_A = -40 to +85°C. V_{BACKUP} = 0 to 3.6V, Typ. values at +25°C, V_{DD} power state

Parameters	Test Conditions	V _{DD}	Min.	Typ.	Max.	Units
V _{DD} Supply Current during I2C burst Read/Write (I _{VDD:I2C})	400kHz bus speed, 2.2k pull-up resistors on SCL/SDA ⁽¹⁾	3.0V		6	10	μA
		1.8V		1.5	3	
V _{DD} Supply Current in XT Oscillator Mode (I _{VDD:XT})	Time keeping mode with XT oscillator running ⁽²⁾	3.0V		60	330	nA
		1.8V		27	290	
V _{DD} Supply Current in RC Oscillator Mode (I _{VDD:RC})	Time keeping mode with only the RC oscillator running (XT oscillator is off) ⁽²⁾	3.0V		17	220	nA
		1.8V		14	170	
Average V _{DD} Supply Current in Autocalibrated RC Oscillator Mode (I _{VDD:ACAL})	Time keeping mode with only the RC oscillator running and Autocalibration enabled. ACP=512 seconds ⁽²⁾	3.0V		22	235	nA
		1.8V		18	190	
Additional V _{DD} Supply Current with CLK/INT at 32.768kHz (I _{VDD:CK32})	Time keeping mode with XT oscillator running, 32.768kHz square wave on CLK/INT ⁽³⁾	3.0V		0.71		μA
		1.8V		0.34		
Additional V _{DD} Supply Current with CLK/INT at 64Hz (I _{VDD:CK64})	All time keeping mode, 64Hz square wave on CLK/INT ⁽³⁾	3.0V		0.6		nA
		1.8V		0.3		

Ultra-low Power Real Time Clock Module with I²C Bus

AB-RTCMC-32.768kHz-IBO5-S3



RoHS/RoHS II compliant

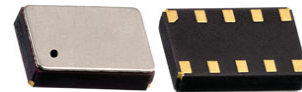

3.7 x 2.5 x 0.9 mm

- (1) Excluding external peripherals and pull-up resistor current. All other inputs (besides SDA and SCL) are at 0V or V_{DD} .
 Test conditions: Continuous burst read/write, 55h data pattern, 25 μ s between each data byte, 20 pF load on each bus pin.
- (2) All inputs and outputs are at 0V or V_{DD} .
- (3) All inputs and outputs except CLK / INT are at 0V or V_{DD} . 15 pF load on CLK / INT, pull-up resistor current not included.

V_{BACKUP} Supply Current

$T_A = -40$ to $+85^\circ\text{C}$. Typ. values at $+25^\circ\text{C}$, Max. values at $+85^\circ\text{C}$. V_{BACKUP} power state

Parameters	Test Conditions	V_{DD}	V_{BACK}	Min.	Typ.	Max.	Units
V_{BACKUP} Supply Current in XT Oscillator Mode ($I_{VBACK:XT}$)	Time keeping mode with XT oscillator running ⁽¹⁾	$<V_{DDSWF}$	3.0V		63	330	nA
			1.8V		60	290	
V_{BACKUP} Supply Current in RC Oscillator Mode ($I_{VBACK:RC}$)	Time keeping mode with only the RC oscillator running (XT oscillator is off) ⁽¹⁾	$<V_{DDSWF}$	3.0V		19	220	nA
			1.8V		16	170	
Average V_{BACKUP} Supply Current in Autocalibrated RC Oscillator Mode ($I_{VBACK:ACAL}$)	Time keeping mode with only the RC oscillator running and Autocalibration enabled. ACP=512 seconds ⁽¹⁾	$<V_{DDSWF}$	3.0V		25	235	nA
			1.8V		21	190	
V_{BACKUP} Supply Current in V_{DD} powered mode ($I_{VBACK:VDD}$)	V_{DD} powered mode ⁽¹⁾	1.7-3.6V	3.0V	-5	0.6	20	nA
			1.8V	-10	0.5	16	

(1) Test conditions: All inputs and outputs are at 0V or V_{DD} .

BREF Electrical Characteristics

$T_A = -20$ to $+70^\circ\text{C}$. Typ. values at $+25^\circ\text{C}$, $V_{DD} = 1.7$ to 3.6V .

Parameters	BREF	Min.	Typ.	Max.	Units
V_{BACKUP} Falling Threshold (V_{BRF})	0111	2.3	2.5	3.3	V
	1011	1.9	2.1	2.8	
	1101	1.6	1.8	2.5	
	1111		1.4		
V_{BACKUP} Rising Threshold (V_{BRR})	0111	2.6	3.0	3.4	V
	1011	2.1	2.5	2.9	
	1101	1.9	2.2	2.7	
	1111		1.6		

Ultra-low Power Real Time Clock Module with I²C Bus

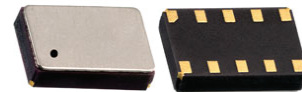

3.7 x 2.5 x 0.9 mm

AB-RTCMC-32.768kHz-IBO5-S3



RoHS/RoHS II compliant

(Continued)

T_A = -20 to +70°C. Typ. values at +25°C, V_{DD} = 1.7 to 3.6V.

Parameters	BREF	Min.	Typ.	Max.	Units
V _{BACKUP} Threshold Hysteresis (V _{BRH})	0111		0.5		V
	1011		0.4		
	1101		0.4		
	1111		0.2		
BREF/BPOL Change to BBOD Valid (t _{BREF})	All valid BREF values		1000		ms
V _{BACKUP} Analog Comparator Recommended Operating Temperature Range (T _{BR})	All valid BREF Values	-20		+70	°C

I²C AC Electrical Characteristics

T_A = -40 to +85°C. Typ. values at +25°C

Parameters	V _{DD}	Min.	Typ.	Max.	Units
SCL Input Clock Frequency (f _{SCL})	1.7 – 3.6V	10		400	kHz
Low Period of SCL Clock (t _{LOW})	1.7 – 3.6V	1.3			µs
High Period of SCL Clock (t _{HIGH})	1.7 – 3.6V	600			ns
Rise Time of SDA and SCL (t _{RISE})	1.7 – 3.6V			300	ns
Fall Time of SDA and SCL (t _{FALL})	1.7 – 3.6V			300	ns
START Condition Hold Time (t _{HD:STA})	1.7 – 3.6V	600			ns
START Condition Setup Time (t _{SU:STA})	1.7 – 3.6V	600			ns
SDA Setup Time (t _{SU:DAT})	1.7 – 3.6V	100			ns
SDA Hold Time (t _{HD:DAT})	1.7 – 3.6V	0			ns
STOP Condition Setup Time (t _{SU:STO})	1.7 – 3.6V	600			ns
Bus Free Time before a New Transmission (t _{BUF})	1.7 – 3.6V	1.3			µs

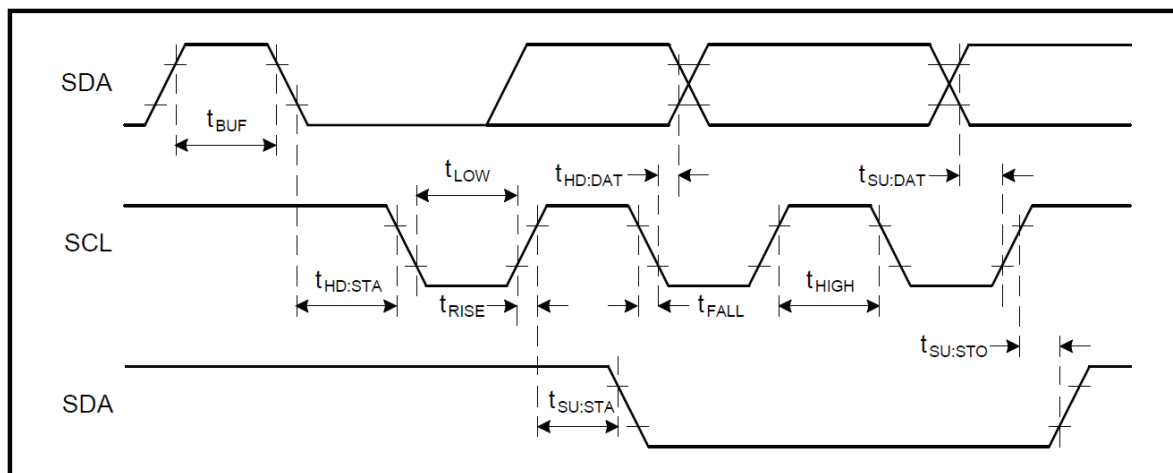

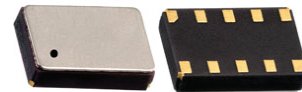

3.7 x 2.5 x 0.9 mm

AB-RTCMC-32.768kHz-IBO5-S3



RoHS/RoHS II compliant

Power-on AC Electrical Characteristics

$T_A = -40$ to $+85^\circ\text{C}$. $V_{\text{BACKUP}} < 1.2\text{V}$

Parameters	V_{DD}	T_A	Min.	Typ.	Max.	Units
Low Period of V_{DD} to Ensure a Valid POR ($t_{\text{LOW:VDD}}$)	1.7 – 3.6V	+85°C		0.1		s
		+25°C		0.1		
		-20°C		1.5		
		-40°C		10		
V_{DD} Low to $\overline{\text{CLK/INT}}$ Low ($t_{\text{VL:CLK}}$)	1.7 – 3.6V	+85°C		0.1		s
		+25°C		0.1		
		-20°C		1.5		
		-40°C		10		
V_{DD} High to $\overline{\text{CLK/INT}}$ High ($t_{\text{VH:CLK}}$)	1.7 – 3.6V	+85°C		0.4		s
		+25°C		0.5		
		-20°C		3		
		-40°C		20		
$\overline{\text{CLK/INT}}$ High to XT Oscillator Start (t_{XTST})	1.7 – 3.6V	+85°C		0.4		s
		+25°C		0.4		
		-20°C		0.5		
		-40°C		1.5		

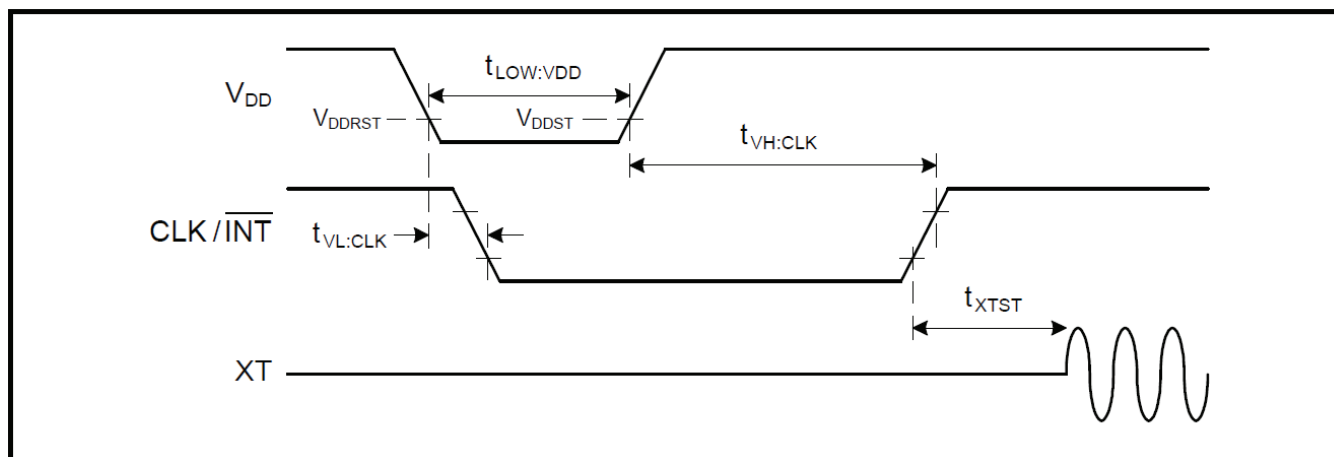

Ultra-low Power Real Time Clock Module with I²C Bus

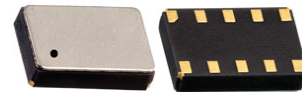

3.7 x 2.5 x 0.9 mm

AB-RTCMC-32.768kHz-IBO5-S3



RoHS/RoHS II compliant

RST AC Electrical Characteristics

$T_A = -40$ to $+85^\circ\text{C}$. $V_{\text{BACKUP}} < 1.2\text{V}$

Parameters	V_{DD}	T_A	Min.	Typ.	Max.	Units
Low Period of V_{DD} to Ensure a Valid POR ($t_{\text{LOW:VDD}}$)	1.7 – 3.6V	+85°C		0.1		s
		+25°C		0.1		
		-20°C		1.5		
		-40°C		10		
V_{DD} Low to $\overline{\text{RST}}$ Low ($t_{\text{VL:NRST}}$)	1.7 – 3.6V	+85°C		0.1		s
		+25°C		0.1		
		-20°C		1.5		
		-40°C		10		
V_{DD} High to $\overline{\text{RST}}$ High ($t_{\text{VH:NRST}}$)	1.7 – 3.6V	+85°C		0.5		s
		+25°C		0.5		
		-20°C		3.5		
		-40°C		25		

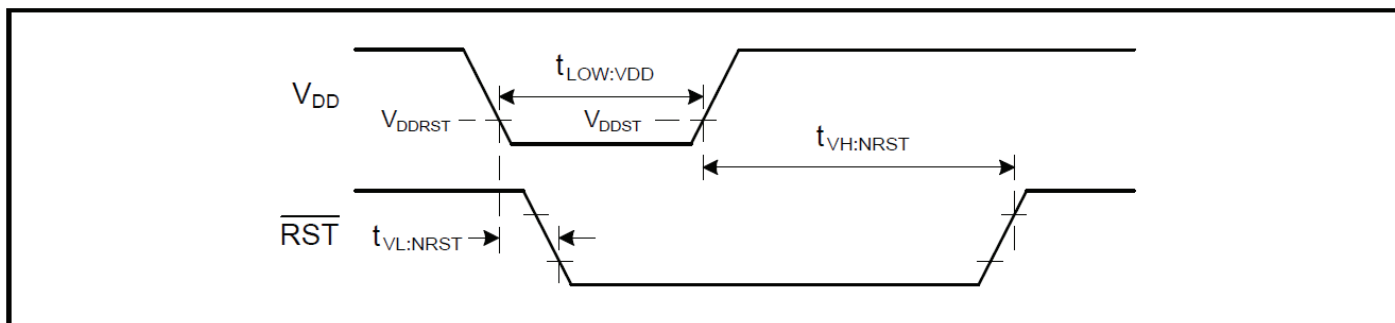

PART IDENTIFICATION:

AB-RTCMC-32.768 kHz-IBO5-S3-



Packaging
Blank: Bulk
T: 1000pcs/reel

Ultra-low Power Real Time Clock Module with I²C Bus

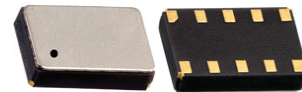

AB-RTCMC-32.768kHz-IBO5-S3



RoHS/RoHS II compliant

3.7 x 2.5 x 0.9 mm

OUTLINE DIMENSION:

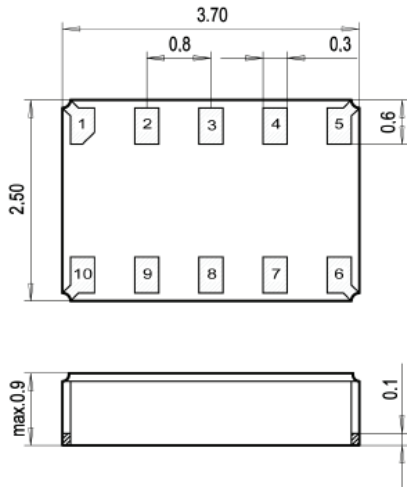

Recommended Land Pattern

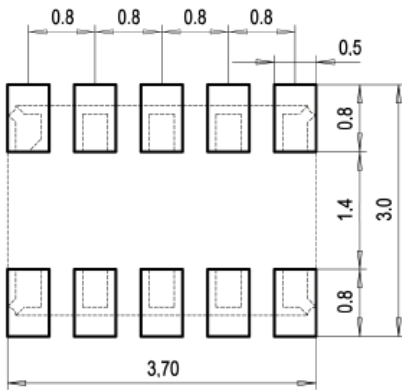

Pin No.	Pin Name	Function
1	V _{DD}	Power Supply Voltage
2	Cap_RC	Capacitor RC-Oscillator
3	CLK/INT	Clock Output/Interrupt
4	SCL	Serial Clock Input
5	SDA	Serial Data
6	V _{SS}	Ground
7	V _{BACKUP}	Backup Supply Voltage
8	PSW	Power Switch Output
9	WDI	Watchdog Input
10	RST	Reset Output

Dimensions: mm

BLOCK DIAGRAM:

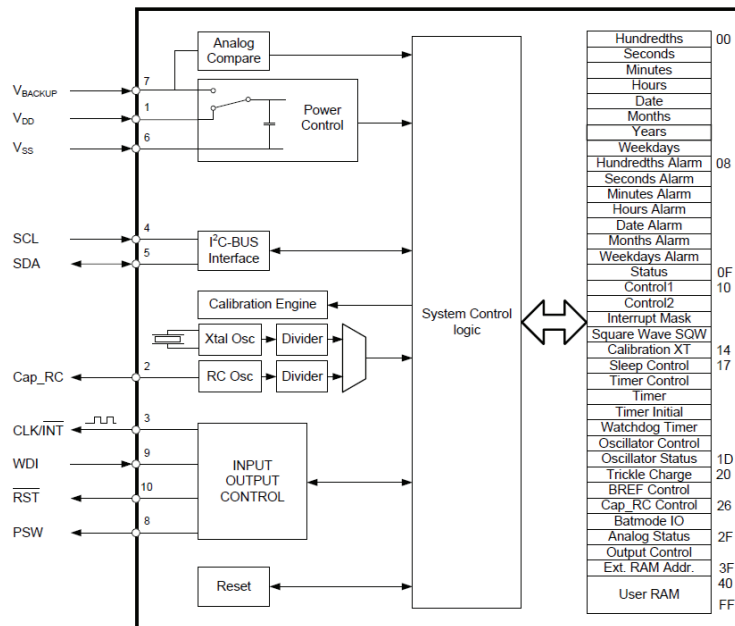

ABRACON IS
ISO 9001 : 2008
CERTIFIED



2 Faraday, Suite# B | Irvine | CA 92618 Revised: 11.16.15

Ph. 949.546.8000 | Fax. 949.546.8001

Visit www.abracon.com for Terms and Conditions of Sale

Ultra-low Power Real Time Clock Module with I²C Bus

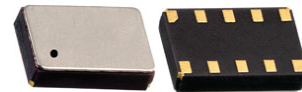

AB-RTCMC-32.768kHz-IBO5-S3



RoHS/RoHS II compliant

3.7 x 2.5 x 0.9 mm

REFLOW PROFILE:

Maximum Reflow Conditions in accordance with IPC/JEDEC J-STD-020C "Pb-free"

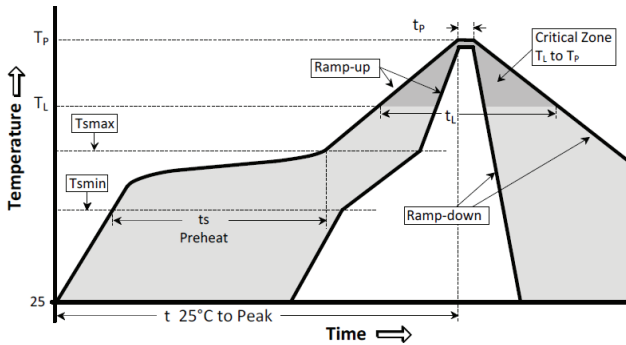

Temperature	Conditions	Units
Average Ramp-up Rate (T_{Smax} to T_p)	3°C/second max	°C/s
Ramp Down Rate (T_{cool})	6°C/second max	°C/s
Time 25°C to Peak Temperature ($T_{to-peak}$)	8 minutes max	m
Preheat		
Temperature Min (T_{Smin})	150	°C
Temperature Max (T_{Smax})	200	°C
Time T_{Smin} to T_{Smax} (t_s)	60 ~ 180	sec
Time Above Liquidus		
Temperature Liquidus (T_l)	217	°C
Time above Liquidus (t_l)	60 ~ 150	sec
Peak Temperature		
Peak Temperature (T_p)	260	°C
Time within 5°C of Peak Temperature (t_p)	20 ~ 40	sec

TAPE & REEL:

T = 1000pcs/reel

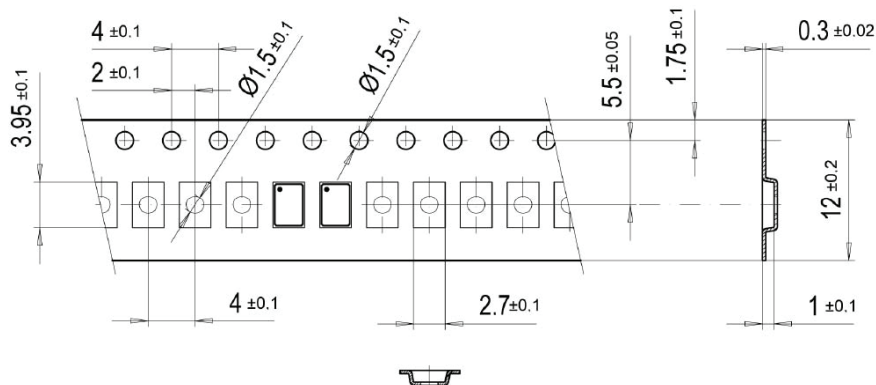

→ User Direction of Feed

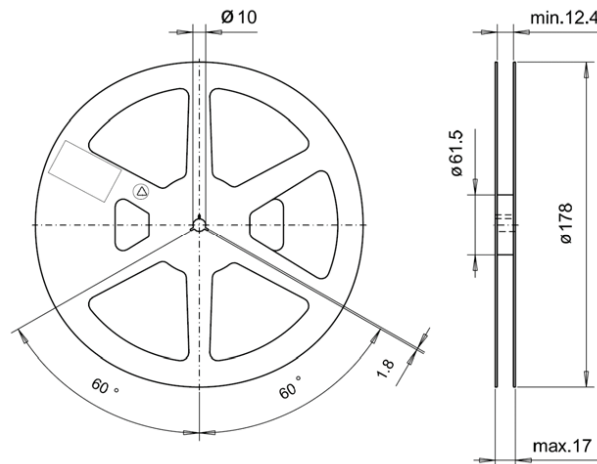

Dimensions: mm

ATTENTION: Abracon Corporation's products are COTS – Commercial-Off-The-Shelf products; suitable for Commercial, Industrial and, where designated, Automotive Applications. Abracon's products are not specifically designed for Military, Aviation, Aerospace, Life-dependant Medical applications or any application requiring high reliability where component failure could result in loss of life and/or property. For applications requiring high reliability and/or presenting an extreme operating environment, written consent and authorization from Abracon Corporation is required. Please contact Abracon Corporation for more information.

ABRACON IS
ISO 9001 : 2008
CERTIFIED



2 Faraday, Suite# B | Irvine | CA 92618 Revised: 11.16.15

Ph. 949.546.8000 | Fax. 949.546.8001

Visit www.abracon.com for Terms and Conditions of Sale

Компания «Life Electronics» занимается поставками электронных компонентов импортного и отечественного производства от производителей и со складов крупных дистрибьюторов Европы, Америки и Азии.

С конца 2013 года компания активно расширяет линейку поставок компонентов по направлению коаксиальный кабель, кварцевые генераторы и конденсаторы (керамические, пленочные, электролитические), за счёт заключения дистрибьюторских договоров

Мы предлагаем:

- Конкурентоспособные цены и скидки постоянным клиентам.
- Специальные условия для постоянных клиентов.
- Подбор аналогов.
- Поставку компонентов в любых объемах, удовлетворяющих вашим потребностям.
- Приемлемые сроки поставки, возможна ускоренная поставка.
- Доставку товара в любую точку России и стран СНГ.
- Комплексную поставку.
- Работу по проектам и поставку образцов.
- Формирование склада под заказчика.
- Сертификаты соответствия на поставляемую продукцию (по желанию клиента).
- Тестирование поставляемой продукции.
- Поставку компонентов, требующих военную и космическую приемку.
- Входной контроль качества.
- Наличие сертификата ISO.

В составе нашей компании организован Конструкторский отдел, призванный помогать разработчикам, и инженерам.

Конструкторский отдел помогает осуществить:

- Регистрацию проекта у производителя компонентов.
- Техническую поддержку проекта.
- Защиту от снятия компонента с производства.
- Оценку стоимости проекта по компонентам.
- Изготовление тестовой платы монтаж и пусконаладочные работы.



Тел: +7 (812) 336 43 04 (многоканальный)

Email: org@lifeelectronics.ru