

MIRELLA-50-S-PIN

~15° spot beam

TECHNICAL SPECIFICATIONS:

Dimensions	Ø 49.9 mm
Height	23.9 mm
Fastening	pin
ROHS compliant	yes 

MATERIAL SPECIFICATIONS:

Component	Type	Material	Colour	Finish	Coating
MIRELLA-50-S-PIN	Reflector	PC	metal		lacquer







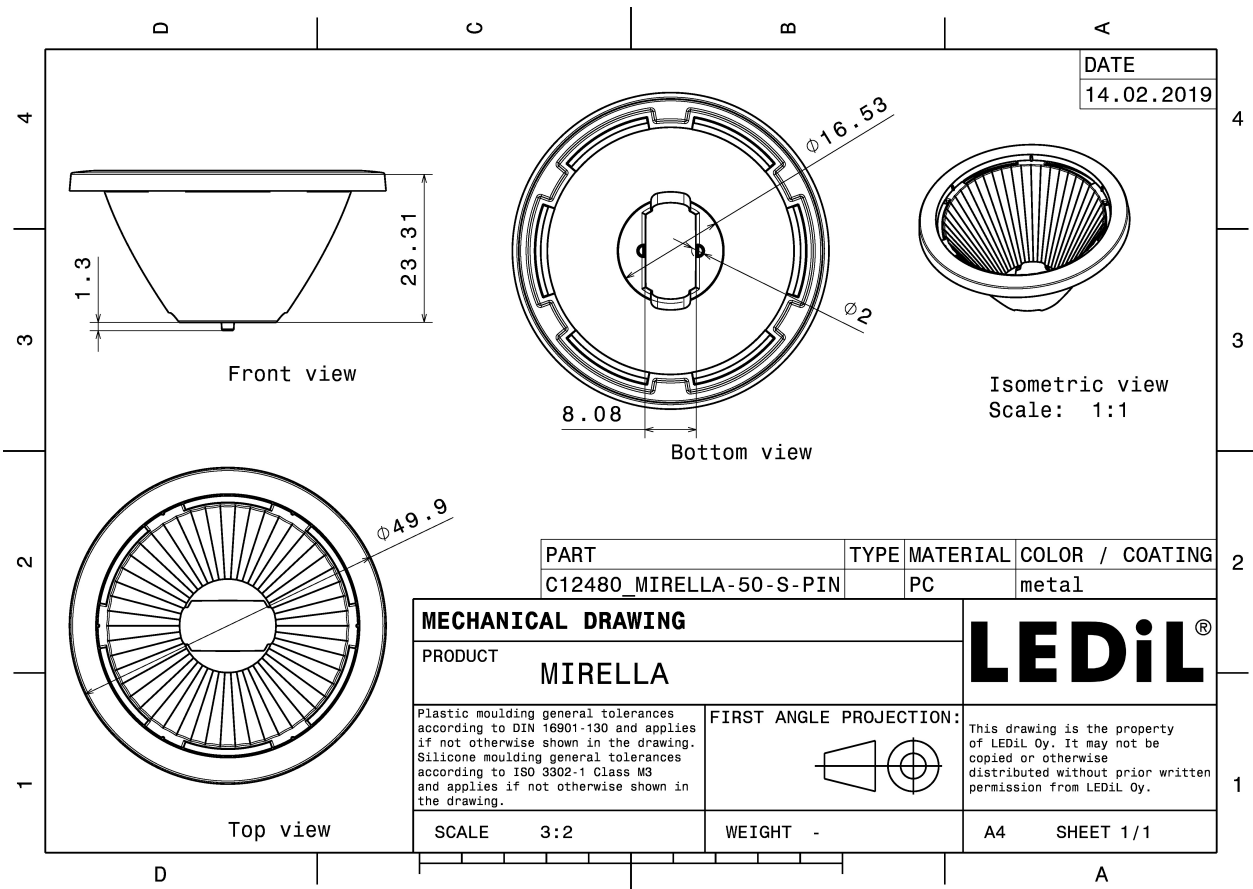

ORDERING INFORMATION:

Component	Qty in box	MOQ	MPQ	Box weight (kg)
C12480_MIRELLA-50-S-PIN » Box size: 480 x 280 x 300 mm	336	112	28	3.0

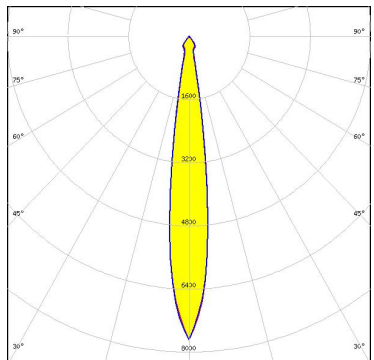

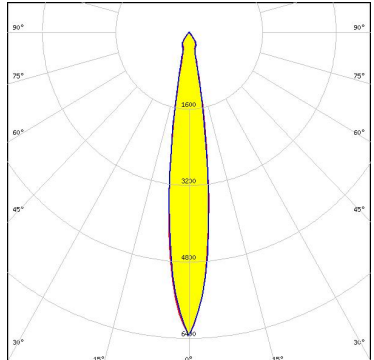
PHOTOMETRIC DATA (MEASURED):

<p>bridgelux.</p> <p>LED SM4 FWHM 15.0° Efficiency 81 % Peak intensity 6.9 cd/lm LEDs/each optic 1 Light colour White Required components: C12479_MIRELLA-DL</p>		
<p>CREE ⇄</p> <p>LED MHB-A/B FWHM 16.0° Efficiency 85 % Peak intensity 7 cd/lm LEDs/each optic 1 Light colour White Required components: C13333_MIRELLA-CL</p>		
<p>CREE ⇄</p> <p>LED MHB-A/B FWHM 17.0° Efficiency 85 % Peak intensity 5.4 cd/lm LEDs/each optic 1 Light colour White Required components: C12479_MIRELLA-DL</p>		
<p>CREE ⇄</p> <p>LED MHB-A/B FWHM 14.0° Efficiency 90 % Peak intensity 9.4 cd/lm LEDs/each optic 1 Light colour White Required components:</p>		

PHOTOMETRIC DATA (MEASURED):

CREE 

LED XHP50
 FWHM 16.0°
 Efficiency 89 %
 Peak intensity 5.3 cd/lm
 LEDs/each optic 1
 Light colour White
 Required components:
 C12479_MIRELLA-DL

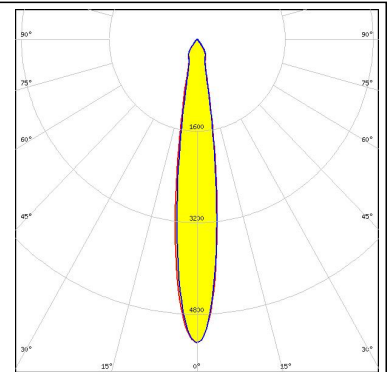

CREE 

LED XHP50
 FWHM 13.0°
 Efficiency 93 %
 Peak intensity 8.8 cd/lm
 LEDs/each optic 1
 Light colour White
 Required components:

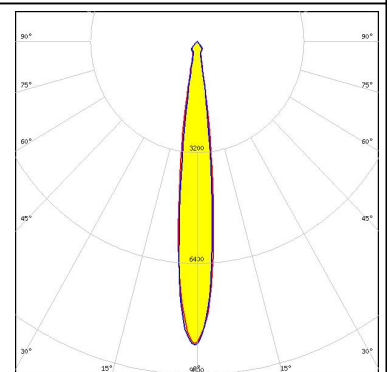

CREE 

LED XHP50
 FWHM 22.0°
 Efficiency 86 %
 Peak intensity 2.8 cd/lm
 LEDs/each optic 1
 Light colour White
 Required components:
 C13723_MIRELLA-RZL

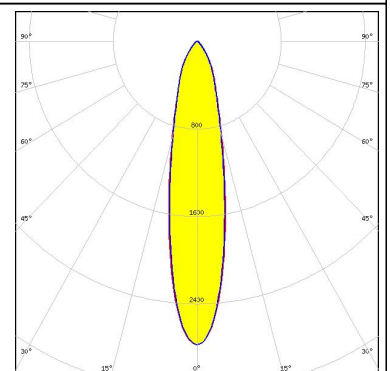
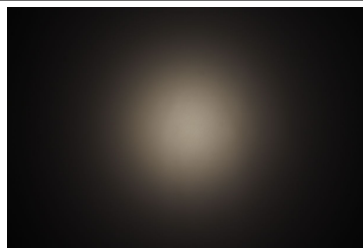

CREE 

LED XHP50
 FWHM 14.0°
 Efficiency 88 %
 Peak intensity 7 cd/lm
 LEDs/each optic 1
 Light colour White
 Required components:
 C13333_MIRELLA-CL

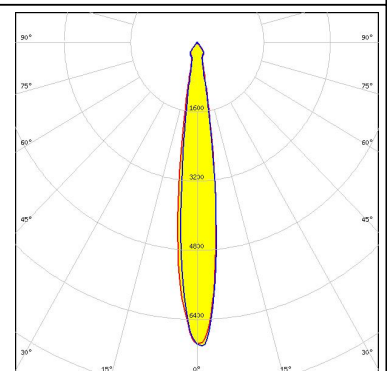

PHOTOMETRIC DATA (MEASURED):

CREE

LED XM-L
FWHM 12.0°
Efficiency 86 %
Peak intensity 8.7 cd/lm
LEDs/each optic 1
Light colour White
Required components:
C12479_MIRELLA-DL



CREE

LED XM-L
FWHM 8.7°
Efficiency 90 %
Peak intensity 19.3 cd/lm
LEDs/each optic 1
Light colour White
Required components:

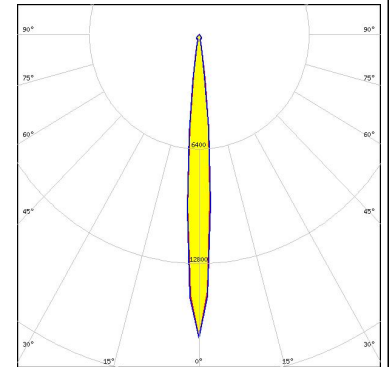

CREE

LED XM-L
FWHM 12.0°
Efficiency 85 %
Peak intensity 11.4 cd/lm
LEDs/each optic 1
Light colour White
Required components:
C13333_MIRELLA-CL



CREE

LED XM-L RGB
FWHM 21.0°
Efficiency 84 %
Peak intensity 3.4 cd/lm
LEDs/each optic 1
Light colour White
Required components:
C13723_MIRELLA-RZL

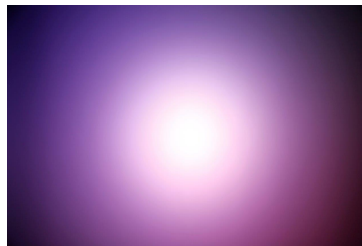

PHOTOMETRIC DATA (MEASURED):

CREE

LED XM-L2
FWHM 12.0°
Efficiency 86 %
Peak intensity 8.2 cd/lm
LEDs/each optic 1
Light colour White
Required components:
C12479_MIRELLA-DL



CREE

LED XM-L2
FWHM 8.6°
Efficiency 91 %
Peak intensity 18.9 cd/lm
LEDs/each optic 1
Light colour White
Required components:

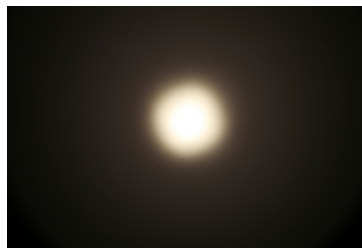

CREE

LED XP-G
FWHM 11.0°
Efficiency 86 %
Peak intensity 10.4 cd/lm
LEDs/each optic 1
Light colour White
Required components:
C12479_MIRELLA-DL

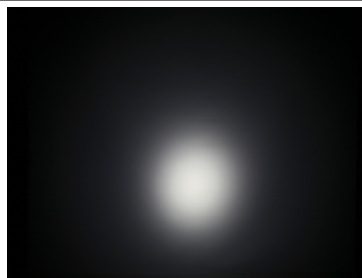

CREE

LED XP-G
FWHM 8.1°
Efficiency 91 %
Peak intensity 25 cd/lm
LEDs/each optic 1
Light colour White
Required components:



PHOTOMETRIC DATA (MEASURED):

CREE 

LED XP-G
FWHM 11.0°
Efficiency 86 %
Peak intensity 14.1 cd/Im
LEDs/each optic 1
Light colour White
Required components:
C13333_MIRELLA-CL



CREE 

LED XP-G2
FWHM 7.9°
Efficiency 91 %
Peak intensity 25.1 cd/Im
LEDs/each optic 1
Light colour White
Required components:



CREE 

LED XP-G2
FWHM 11.0°
Efficiency 87 %
Peak intensity 10.4 cd/Im
LEDs/each optic 1
Light colour White
Required components:
C12479_MIRELLA-DL

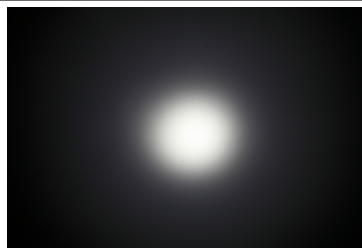

CREE 

LED XP-L HI
FWHM 7.7°
Efficiency 90 %
Peak intensity 24.9 cd/Im
LEDs/each optic 1
Light colour White
Required components:

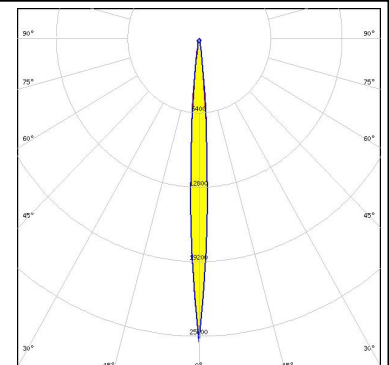
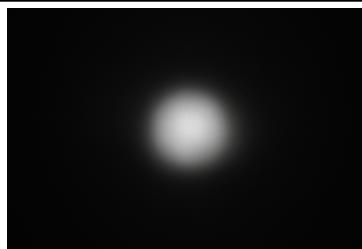

PHOTOMETRIC DATA (MEASURED):

CREE

LED XT-E
 FWHM 11.0°
 Efficiency 85 %
 Peak intensity 9.9 cd/lm
 LEDs/each optic 1
 Light colour White
 Required components:
 C12479_MIRELLA-DL



CREE

LED XT-E
 FWHM 7.6°
 Efficiency 89 %
 Peak intensity 24 cd/lm
 LEDs/each optic 1
 Light colour White
 Required components:



CREE

LED XT-E
 FWHM 10.0°
 Efficiency 84 %
 Peak intensity 14.1 cd/lm
 LEDs/each optic 1
 Light colour White
 Required components:
 C13333_MIRELLA-CL



LUMILEDS

LED LUXEON 5050 Round LES
 FWHM 11.0°
 Efficiency 93 %
 Peak intensity 11.9 cd/lm
 LEDs/each optic 1
 Light colour White
 Required components:

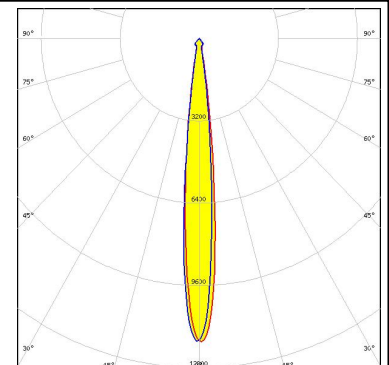
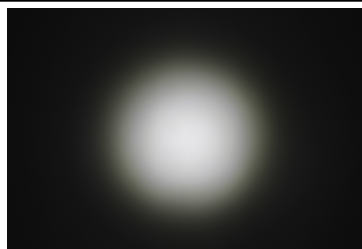

PHOTOMETRIC DATA (MEASURED):

LUMILEDS

LED LUXEON A
FWHM 12.0°
Efficiency 85 %
Peak intensity 8.9 cd/lm
LEDs/each optic 1
Light colour White
Required components:
C12479_MIRELLA-DL



LUMILEDS

LED LUXEON A
FWHM 8.9°
Efficiency 89 %
Peak intensity 20.5 cd/lm
LEDs/each optic 1
Light colour White
Required components:



LUMILEDS

LED LUXEON A
FWHM 10.0°
Efficiency 85 %
Peak intensity 14.5 cd/lm
LEDs/each optic 1
Light colour White
Required components:
C13333_MIRELLA-CL



LUMILEDS

LED LUXEON C
FWHM 22.0°
Efficiency 81 %
Peak intensity 3.1 cd/lm
LEDs/each optic 4
Light colour RGBW
Required components:
C13723_MIRELLA-RZL

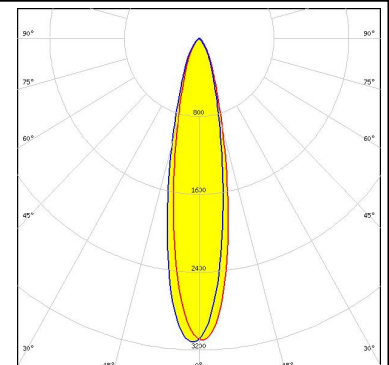
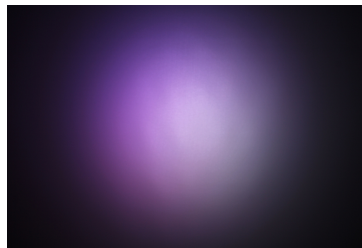

PHOTOMETRIC DATA (MEASURED):

LUMILEDS

LED LUXEON M/MX
FWHM 15.0°
Efficiency 86 %
Peak intensity 5.9 cd/lm
LEDs/each optic 1
Light colour White
Required components:
C12479_MIRELLA-DL



LUMILEDS

LED LUXEON M/MX
FWHM 12.0°
Efficiency 91 %
Peak intensity 10.3 cd/lm
LEDs/each optic 1
Light colour White
Required components:

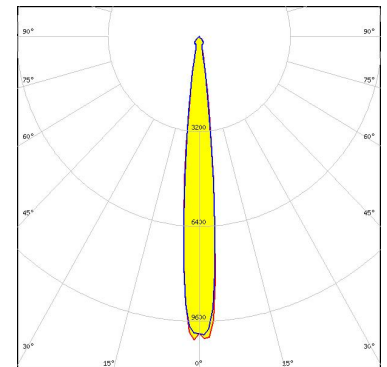

LUMILEDS

LED LUXEON M/MX
FWHM 15.0°
Efficiency 85 %
Peak intensity 7.2 cd/lm
LEDs/each optic 1
Light colour White
Required components:
C13333_MIRELLA-CL



LUMILEDS

LED LUXEON MZ
FWHM 11.0°
Efficiency 85 %
Peak intensity 9.3 cd/lm
LEDs/each optic 1
Light colour White
Required components:
C12479_MIRELLA-DL



PHOTOMETRIC DATA (MEASURED):

LUMILEDS

LED LUXEON MZ
FWHM 8.7°
Efficiency 90 %
Peak intensity 19.3 cd/lm
LEDs/each optic 1
Light colour White
Required components:

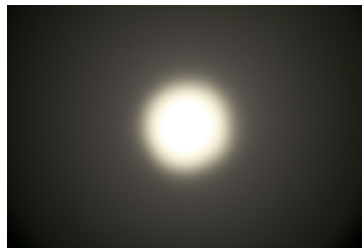

LUMILEDS

LED LUXEON Z
FWHM 18.0°
Efficiency 82 %
Peak intensity 3.4 cd/lm
LEDs/each optic 4
Light colour RGBW
Required components:
C13723_MIRELLA-RZL

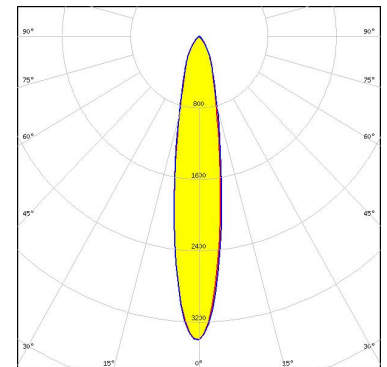
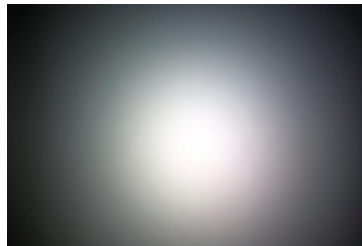

NICHIA

LED NS9x383
FWHM 12.0°
Efficiency 85 %
Peak intensity 8.4 cd/lm
LEDs/each optic 1
Light colour White
Required components:
C12479_MIRELLA-DL





NICHIA



LED NS9x383
FWHM 9.2°
Efficiency 89 %
Peak intensity 17.7 cd/lm
LEDs/each optic 1
Light colour White
Required components:

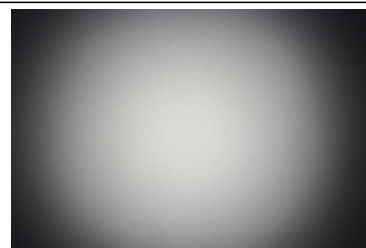
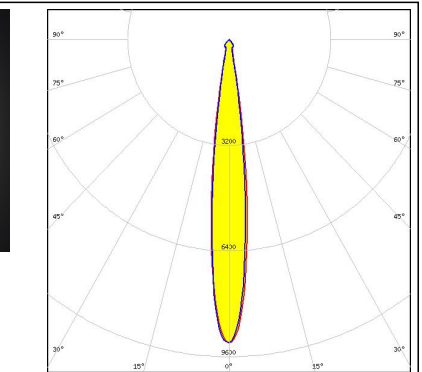

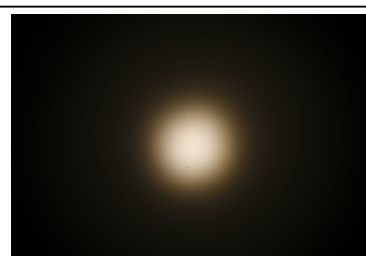
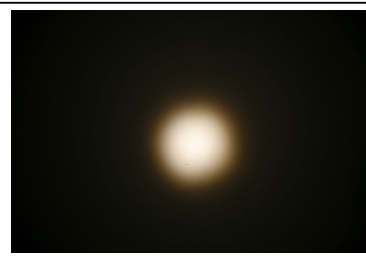
PHOTOMETRIC DATA (MEASURED):

<p>NICHIA</p> <p>LED NV4x144A FWHM 13.0° Efficiency 92 % Peak intensity 9.2 cd/lm LEDs/each optic 1 Light colour White Required components:</p>		
<p>OSRAM <small>Opto Semiconductors</small></p> <p>LED Duris S8 FWHM 11.0° Efficiency 86 % Peak intensity 11.6 cd/lm LEDs/each optic 1 Light colour White Required components: C13333_MIRELLA-CL</p>		
<p>OSRAM <small>Opto Semiconductors</small></p> <p>LED Duris S8 FWHM 12.0° Efficiency 86 % Peak intensity 8.3 cd/lm LEDs/each optic 1 Light colour White Required components: C12479_MIRELLA-DL</p>		
<p>OSRAM <small>Opto Semiconductors</small></p> <p>LED Duris S8 FWHM 9.7° Efficiency 91 % Peak intensity 16 cd/lm LEDs/each optic 1 Light colour White Required components:</p>		

PHOTOMETRIC DATA (MEASURED):

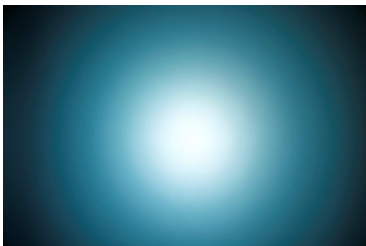
<p>OSRAM Opto Semiconductors</p> <p>LED OSLON Square EC FWHM 11.0° Efficiency 85 % Peak intensity 9.7 cd/lm LEDs/each optic 1 Light colour White Required components: C12479_MIRELLA-DL</p>	
<p>OSRAM Opto Semiconductors</p> <p>LED OSLON Square EC FWHM 8.0° Efficiency 90 % Peak intensity 23.6 cd/lm LEDs/each optic 1 Light colour White Required components:</p>	
<p>OSRAM Opto Semiconductors</p> <p>LED OSLON Square EC FWHM 9.4° Efficiency 85 % Peak intensity 15.4 cd/lm LEDs/each optic 1 Light colour White Required components: C13333_MIRELLA-CL</p>	
<p>OSRAM Opto Semiconductors</p> <p>LED Ostar-SMT RGB FWHM 19.0° Efficiency 85 % Peak intensity 3.7 cd/lm LEDs/each optic 1 Light colour White Required components: C13723_MIRELLA-RZL</p>	

PHOTOMETRIC DATA (MEASURED):

SAMSUNG

LED LH508A
 FWHM 12.0°
 Efficiency 90 %
 Peak intensity 10.5 cd/lm
 LEDs/each optic 1
 Light colour White
 Required components:

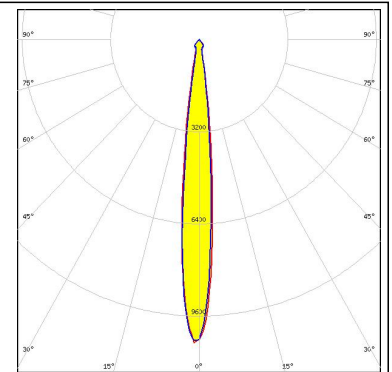

SEOUL SEMICONDUCTOR

LED F50360 (RGB)
 FWHM 21.0°
 Efficiency 84 %
 Peak intensity 3.3 cd/lm
 LEDs/each optic 1
 Light colour White
 Required components:
 C13723_MIRELLA-RZL

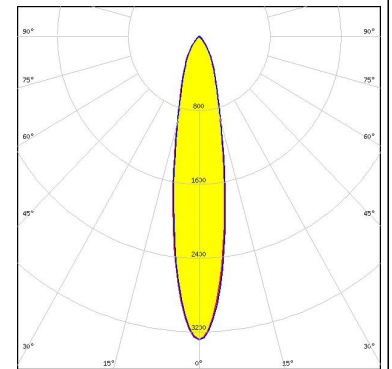
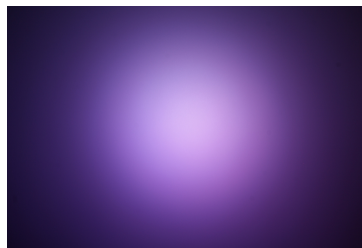

SEOUL SEMICONDUCTOR

LED F50360 (RGB)
 FWHM 19.0°
 Efficiency 86 %
 Peak intensity 3.8 cd/lm
 LEDs/each optic 1
 Light colour White
 Required components:
 C13723_MIRELLA-RZL

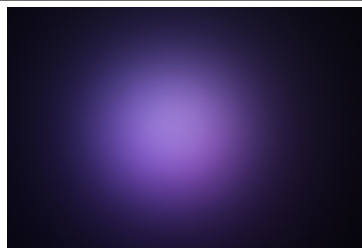

PHOTOMETRIC DATA (SIMULATED):

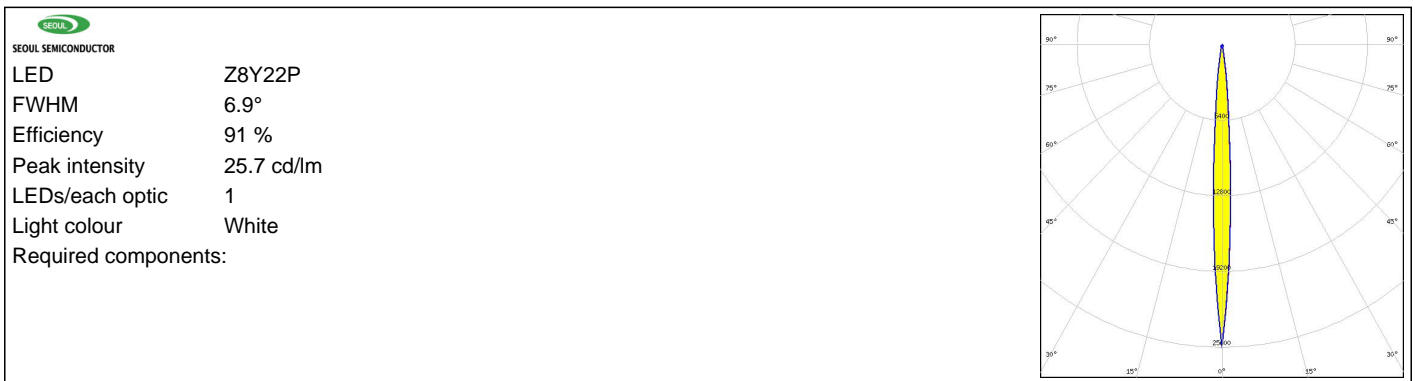

GENERAL INFORMATION:

NOTE: The typical beam angle will be changed by different color, chip size and chip position tolerance. The typical total beam angle is the full angle measured where the luminous intensity is half of the peak value.

MATERIALS:

As part of our continuous research and improvement processes, and to ensure the best possible quality and availability of our products, LEDiL reserves the right to change material grades without notice.

PRODUCT DATA USER AGREEMENT AND DISCLAIMER:

The measured data in the provided downloadable LEDiL Product Datasheets and Mechanical 2D-Drawings is rounded and provided as reference for planning. LEDiL Oy's optical specifications have been verified by conducting performance testing of the products in accordance with the company's quality system. The reported data are averaged results of multiple measurements with typical variation. LEDiL Oy reserves the right to without prior notification make changes and improvements to its products.

LEDiL Oy assumes neither warranty, nor guarantee nor any other liability of any kind for the contents and correctness of the provided data. The provided data has been generated with highest diligence but the provided data may in reality not represent the complete possible variation range of all intrinsic parameters. Therefore, in certain cases a deviation from the provided data could occur.

LEDiL Oy reserves the right to undertake technical changes of its products without further notification which could lead to changes in the provided data. LEDiL Oy assumes no liability of any kind for the possible deviation from any provided data or any other damage resulting from the usage of the provided data.

The user agrees to this disclaimer and user agreement with the download or usage of the provided files.

LEDiL Oy

Joensuunkatu 13
FI-24240 SALO
Finland

LEDiL Inc.

228 West Page Street
Suite D
Sycamore IL 60178
USA

Local sales and technical support

[www.ledil.com/
where_to_buy](http://www.ledil.com/where_to_buy)

Shipping locations

Salo, Finland
Hong Kong, China

Distribution Partners

[www.ledil.com/
where_to_buy](http://www.ledil.com/where_to_buy)

Компания «Life Electronics» занимается поставками электронных компонентов импортного и отечественного производства от производителей и со складов крупных дистрибьюторов Европы, Америки и Азии.

С конца 2013 года компания активно расширяет линейку поставок компонентов по направлению коаксиальный кабель, кварцевые генераторы и конденсаторы (керамические, пленочные, электролитические), за счёт заключения дистрибьюторских договоров

Мы предлагаем:

- Конкуренспособные цены и скидки постоянным клиентам.
- Специальные условия для постоянных клиентов.
- Подбор аналогов.
- Поставку компонентов в любых объемах, удовлетворяющих вашим потребностям.
- Приемлемые сроки поставки, возможна ускоренная поставка.
- Доставку товара в любую точку России и стран СНГ.
- Комплексную поставку.
- Работу по проектам и поставку образцов.
- Формирование склада под заказчика.
- Сертификаты соответствия на поставляемую продукцию (по желанию клиента).
- Тестирование поставляемой продукции.
- Поставку компонентов, требующих военную и космическую приемку.
- Входной контроль качества.
- Наличие сертификата ISO.

В составе нашей компании организован Конструкторский отдел, призванный помогать разработчикам, и инженерам.

Конструкторский отдел помогает осуществить:

- Регистрацию проекта у производителя компонентов.
- Техническую поддержку проекта.
- Защиту от снятия компонента с производства.
- Оценку стоимости проекта по компонентам.
- Изготовление тестовой платы монтаж и пусконаладочные работы.



Тел: +7 (812) 336 43 04 (многоканальный)

Email: org@lifeelectronics.ru