

### Cree® P4 LED CP41A-RDS/ADS CP41A-RFS/AFS CP41A-RHS/AHS



#### PRODUCT DESCRIPTION

This revolutionary package design allows the lighting designer to reduce the number of LEDs required and provide a more uniform and unique illuminated appearance than with other LED solutions.

This is possible through the efficient optical-package design and high-current capabilities. The low-profile package can be easily coupled with reflectors or lenses to efficiently distribute light and provide the desired lit appearance. This product family employs green and blue LED materials, which allows designers to match the color of many lighting applications such as vehicle signal lamps and amusement lighting.

#### FEATURES

- Size (mm): 7.6 x 7.6
- Color and Typical Dominant Wavelength:  
Red (624nm)  
Amber(591nm)
- Luminous Flux (mlm)  
CP41A-RDS:(4400-11000)  
CP41A-RFS:(4400-11000)  
CP41A-RHS:(4400-11000)  
CP41A-ADS:(4400-11000)  
CP41A-AFS:(4400-11000)  
CP41A-AHS:(4400-11000)
- Lead - Free
- RoHS Compliant

#### APPLICATIONS

- Channel Letter
- Amusement

## ABSOLUTE MAXIMUM RATINGS ( $T_A = 25^\circ\text{C}$ )

Items	Symbol	Absolute Maximum Rating	Unit
		Red/Amber	
Forward Current	$I_F$	70 <sup>Note1</sup>	mA
Peak Forward Current <sup>Note2</sup>	$I_{FP}$	100	mA
Reverse Voltage	$V_R$	5	V
Power Dissipation	$P_D$ (Red)	238	mW
	$P_D$ (Amber)	224	mW
Operation Temperature	$T_{opr}$	-40 ~ +100	$^\circ\text{C}$
Storage Temperature	$T_{stg}$	-40 ~ +100	$^\circ\text{C}$
Lead Soldering Temperature	$T_{sol}$	Max. 260 $^\circ\text{C}$ for 5 sec. max. (3 mm from the base of the epoxy bulb)	
Electrostatic Discharge Classification (MIL-STD-883E)	ESD	Class 2	

### Note:

1. A heat sink is recommended if the device is operated at ambient temperatures higher than 25 $^\circ\text{C}$ .
2. Pulse width  $\leq 0.1$  msec, duty  $\leq 1/10$ .

## TYPICAL ELECTRICAL & OPTICAL CHARACTERISTICS ( $T_A = 25^\circ\text{C}$ )

Characteristics	Color	Symbol	Condition	Unit	Minimum	Typical	Maximum
Forward Voltage	Red	$V_F$	$I_F = 70$ mA	V		2.3	3.2
	Amber	$V_F$	$I_F = 70$ mA	V		2.5	3.2
Reverse Current	Red/Amber	$I_R$	$V_R = 5$ V	$\mu\text{A}$			100
Dominant Wavelength	Red	$\lambda_D$	$I_F = 70$ mA	nm	620	624	630
	Amber	$\lambda_D$	$I_F = 70$ mA	nm	587	591	596
Luminous Flux	Red	CP41A-RDS (40 degree)	$\Phi_v$	$I_F = 70$ mA	mIm	4400	5300
		CP41A-RFS (70 degree)	$\Phi_v$	$I_F = 70$ mA	mIm	4400	5500
		CP41A-RHS (100 degree)	$\Phi_v$	$I_F = 70$ mA	mIm	4400	6000
	Amber	CP41A-ADS (40 degree)	$\Phi_v$	$I_F = 70$ mA	mIm	4400	6200
		CP41A-AFS (70 degree)	$\Phi_v$	$I_F = 70$ mA	mIm	4400	6600
		CP41A-AHS (100 degree)	$\Phi_v$	$I_F = 70$ mA	mIm	4400	7200
50% Power Angle	CP41A-RDS/ADS	$2\theta_{1/2}$	$I_F = 70$ mA	deg		40	
	CP41A-RFS/AFS	$2\theta_{1/2}$	$I_F = 70$ mA	deg		70	
	CP41A-RHS/AHS	$2\theta_{1/2}$	$I_F = 70$ mA	deg		100	

## FLUX BIN LIMIT ( $I_F = 70 \text{ mA}$ )

Red

CP41A-RDS/RFS/RHS (40/70/100 degree)

Bin Code	Min.(mlm)	Max.(mlm)
L0	4400	5500
M0	5500	6600
N0	6600	8730
P0	8730	11000

Amber

CP41A-ADS/AFS/AHS (40/70/100 degree)

Bin Code	Min.(mlm)	Max.(mlm)
L0	4400	5500
M0	5500	6600
N0	6600	8730
P0	8730	11000

- Tolerance of measurement of luminous flux is  $\pm 15\%$

## COLOR BIN LIMIT ( $I_F = 70 \text{ mA}$ )

Red

Bin Code	Min.(nm)	Max.(nm)
RJ	620	630

Amber

Bin Code	Min.(nm)	Max.(nm)
A3	587	590
A4	590	593
A5	593	596

- Tolerance of measurement of dominant wavelength is  $\pm 1 \text{ nm}$

## VF BIN LIMIT ( $I_F = 70 \text{ mA}$ )

Red

Bin Code	Min.(V)	Max.(V)
23	2.0	2.2
24	2.2	2.4
25	2.4	2.6
26	2.6	2.8
27	2.8	3.0
28	3.0	3.2

Amber

Bin Code	Min.(V)	Max.(V)
23	2.0	2.2
24	2.2	2.4
25	2.4	2.6
26	2.6	2.8
27	2.8	3.0
28	3.0	3.2

- Tolerance of measurement of VF is  $\pm 0.05\text{V}$ .

### ORDER CODE TABLE\*

Color	Kit Number	Viewing Angle	Luminous Flux (mlm)		Dominant Wavelength			
			Min.	Max.	Color Bin	Min. (nm)	Color Bin	Max. (nm)
Red	CP41A-RDS-CL0P0JJ4	40	4400	11000	RJ	620	RJ	630

Color	Kit Number	Viewing Angle	Luminous Flux (mlm)		Dominant Wavelength			
			Min.	Max.	Color Bin	Min. (nm)	Color Bin	Max. (nm)
Red	CP41A-RFS-CL0P0JJ4	70	4400	11000	RJ	620	RJ	630

Color	Kit Number	Viewing Angle	Luminous Flux (mlm)		Dominant Wavelength			
			Min.	Max.	Color Bin	Min. (nm)	Color Bin	Max. (nm)
Red	CP41A-RHS-CL0P0JJ4	100	4400	11000	RJ	620	RJ	630
Red	CP41A-RHS-CM0P0JJ4	100	5500	11000	RJ	620	RJ	630
Red	CP41A-RHS-CN0P0JJ4	100	6600	11000	RJ	620	RJ	630

Color	Kit Number	Viewing Angle	Luminous Flux (mlm)		Dominant Wavelength			
			Min.	Max.	Color Bin	Min. (nm)	Color Bin	Max. (nm)
Amber	CP41A-ADS-CL0P0354	40	4400	11000	A3	587	A5	596
Amber	CP41A-ADS-CL0P0454	40	4400	11000	A4	590	A5	596

Color	Kit Number	Viewing Angle	Luminous Flux (mlm)		Dominant Wavelength			
			Min.	Max.	Color Bin	Min. (nm)	Color Bin	Max. (nm)
Amber	CP41A-AFS-CL0P0354	70	4400	11000	A3	587	A5	596
Amber	CP41A-AFS-CL0P0454	70	4400	11000	A4	590	A5	596
Amber	CP41A-AFS-CM0P0354	70	5500	11000	A3	587	A5	596

Color	Kit Number	Viewing Angle	Luminous Flux (mlm)		Dominant Wavelength			
			Min.	Max.	Color Bin	Min. (nm)	Color Bin	Max. (nm)
Amber	CP41A-AHS-CL0P0354	100	4400	11000	A3	587	A5	596
Amber	CP41A-AHS-CM0P0354	100	5500	11000	A3	587	A5	596
Amber	CP41A-AHS-CM0P0454	100	5500	11000	A4	590	A5	596

Notes:

- The above kit numbers represent order codes which include multiple flux-bin and color-bin codes. Only one flux-bin code and one color-bin code will be shipped on each reel. And single flux-bin code, single color bin-codes will not be orderable.
- Please refer to the "Cree LED Lamp Reliability Test Standards" document for reliability test conditions.
- Please refer to the "Cree LED Lamp Soldering & Handling" document for information about how to use this LED product safely.

## GRAPHS



FIG.1 FORWARD CURRENT VS. FORWARD VOLTAGE.



FIG.2 RELATIVE LUMINOUS FLUX VS. FORWARD CURRENT



FIG.3 Red & Amber REVERSE CURRENT VS. REVERSE VOLTAGE.

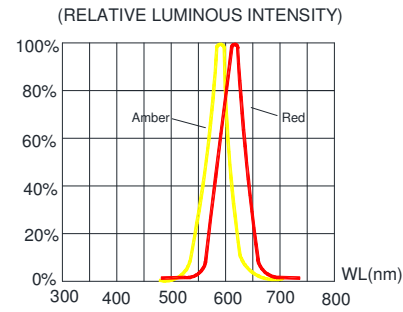

FIG.4 RELATIVE LUMINOUS INTENSITY VS. WAVELENGTH.

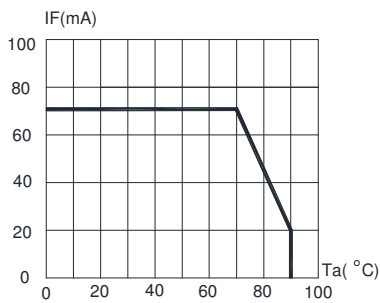

FIG.5 Red & Amber MAXIMUM FORWARD DC CURRENT VS AMBIENT TEMPERATURE (Tjmax=110°C)

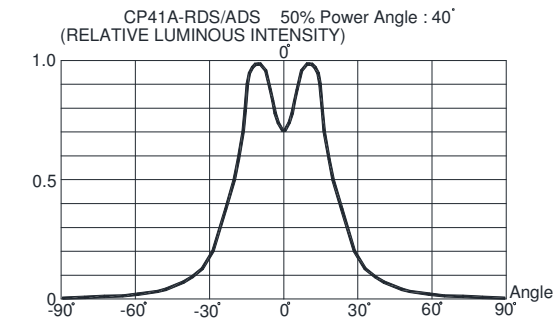

FIG.6 FAR FIELD PATTERN

The above data are collected from statistical figures that do not necessarily correspond to the actual parameters of each single LED. Hence, these data will be changed without further notice.



## MECHANICAL DIMENSIONS

All dimensions are in mm. Tolerance is  $\pm 0.25$  mm unless otherwise noted.

An epoxy meniscus may extend about 1.5 mm down the leads.

Burr around bottom of epoxy may be 0.5 mm max.

CP41A-RDS/ADS:

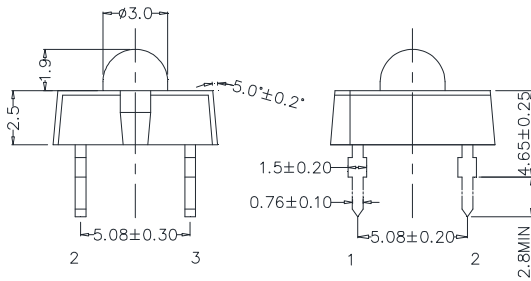

2,3: ANODE  
 1,4: CATHODE

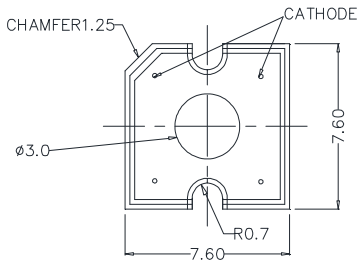

CP41A-RFS/AFS:

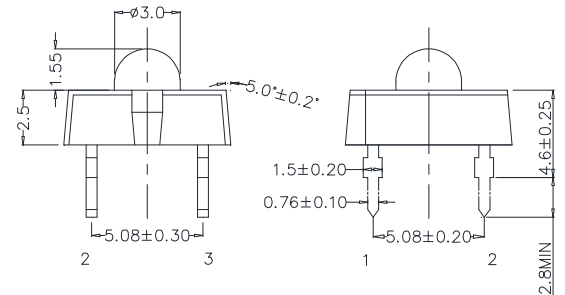

2,3: ANODE  
 1,4: CATHODE

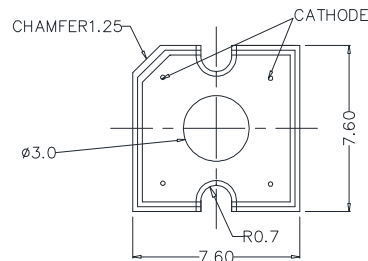

## NOTES

### RoHS Compliance

The levels of environmentally sensitive, persistent biologically toxic (PBT), persistent organic pollutants (POP), or otherwise restricted materials in this product are below the maximum concentration values (also referred to as the threshold limits) permitted for such substances, or are used in an exempted application, in accordance with EU Directive 2002/95/EC on the restriction of the use of certain hazardous substances in electrical and electronic equipment (RoHS), as amended through April 21, 2006.

### Vision Advisory Claim

Users should be cautioned not to stare at the light of this LED product. The bright light can damage the eye.

## MECHANICAL DIMENSIONS

All dimensions are in mm. Tolerance is  $\pm 0.25$  mm unless otherwise noted.

An epoxy meniscus may extend about 1.5 mm down the leads.

Burr around bottom of epoxy may be 0.5 mm max.

CP41A-RHS/AHS:



## NOTES

### RoHS Compliance

The levels of environmentally sensitive, persistent biologically toxic (PBT), persistent organic pollutants (POP), or otherwise restricted materials in this product are below the maximum concentration values (also referred to as the threshold limits) permitted for such substances, or are used in an exempted application, in accordance with EU Directive 2002/95/EC on the restriction of the use of certain hazardous substances in electrical and electronic equipment (RoHS), as amended through April 21, 2006.

### Vision Advisory Claim

Users should be cautioned not to stare at the light of this LED product. The bright light can damage the eye.



## KIT NUMBER SYSTEM

All dimensions in mm. Cree LED lamps are tested and sorted into performance bins. A bin is specified by ranges of color, forward voltage, and brightness. Sorted LEDs are packaged for shipping in various convenient options. Please refer to the "Cree LED Lamp Packaging Standard" document for more information about shipping and packaging options.

Cree LEDs are sold by order codes in combinations of bins called kits. Order codes are configured in the following manner:



## PACKAGING

### Features:

- The LEDs are packed in cardboard boxes after packaging in normal or anti-electrostatic bags.
- Cardboard boxes will be used to protect the LEDs from mechanical shock during transportation.
- The boxes are not water resistant, and they must be kept away from water and moisture.
- The Tube Pack type of packaging.
- Max 60 pcs per tube.

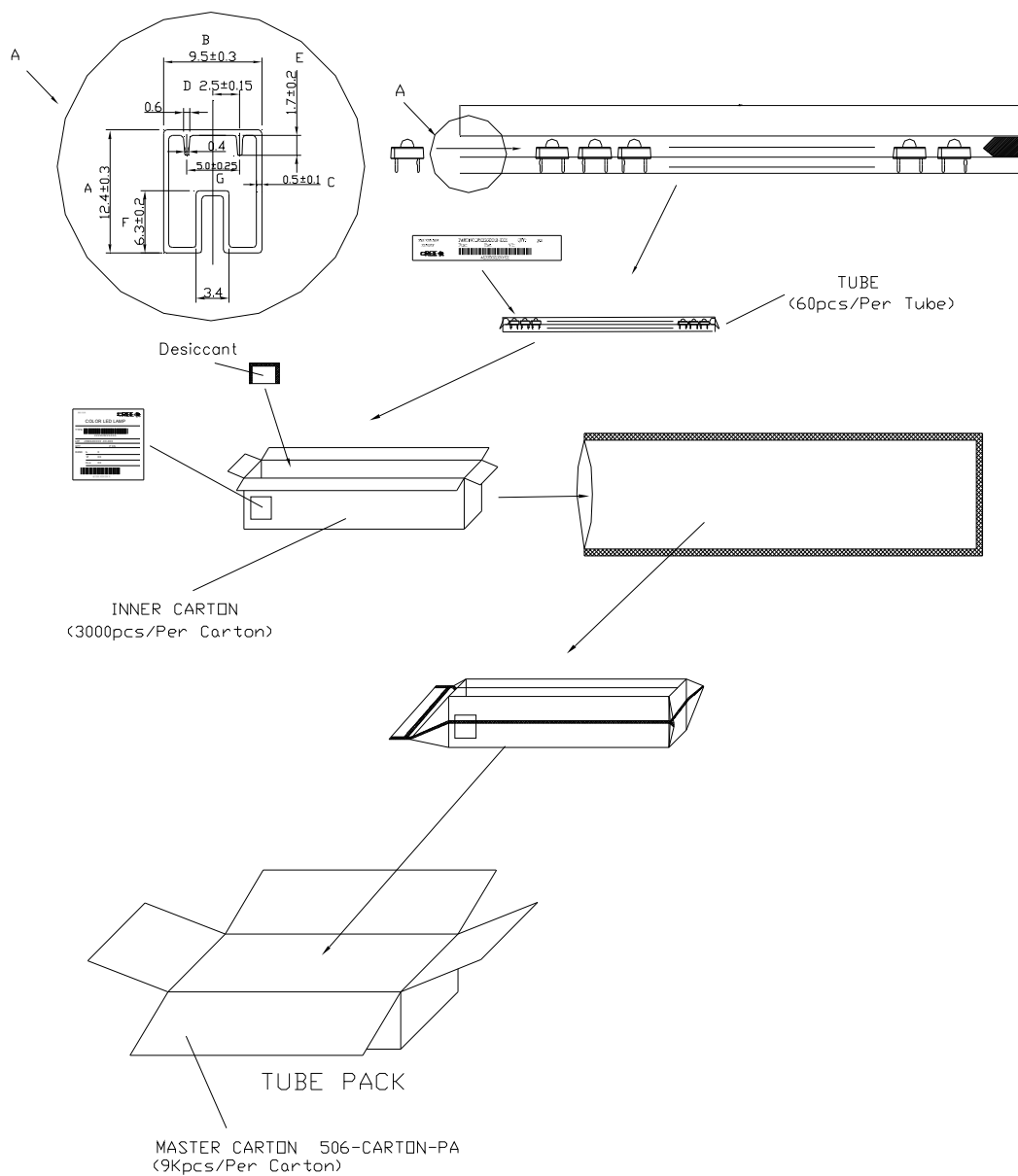

Компания «Life Electronics» занимается поставками электронных компонентов импортного и отечественного производства от производителей и со складов крупных дистрибьюторов Европы, Америки и Азии.

С конца 2013 года компания активно расширяет линейку поставок компонентов по направлению коаксиальный кабель, кварцевые генераторы и конденсаторы (керамические, пленочные, электролитические), за счёт заключения дистрибьюторских договоров

Мы предлагаем:

- Конкурентоспособные цены и скидки постоянным клиентам.
- Специальные условия для постоянных клиентов.
- Подбор аналогов.
- Поставку компонентов в любых объемах, удовлетворяющих вашим потребностям.
- Приемлемые сроки поставки, возможна ускоренная поставка.
- Доставку товара в любую точку России и стран СНГ.
- Комплексную поставку.
- Работу по проектам и поставку образцов.
- Формирование склада под заказчика.
- Сертификаты соответствия на поставляемую продукцию (по желанию клиента).
- Тестирование поставляемой продукции.
- Поставку компонентов, требующих военную и космическую приемку.
- Входной контроль качества.
- Наличие сертификата ISO.

В составе нашей компании организован Конструкторский отдел, призванный помогать разработчикам, и инженерам.

Конструкторский отдел помогает осуществить:

- Регистрацию проекта у производителя компонентов.
- Техническую поддержку проекта.
- Защиту от снятия компонента с производства.
- Оценку стоимости проекта по компонентам.
- Изготовление тестовой платы монтаж и пусконаладочные работы.



Тел: +7 (812) 336 43 04 (многоканальный)  
Email: [org@lifeelectronics.ru](mailto:org@lifeelectronics.ru)