

General Purpose Relay G7L

- Ideally suited for high-inrush fluid pump controls: pool/spa, water processing, emergency, chemical industry, etc.
- High-capacity, high-withstand voltage relay with no contact chattering for momentary voltage drops up to 50% of rated voltage.
- UL Class B construction standard.
- Wide-range AC-activated coil that handles 100 to 120 VAC at either 50 or 60 Hz.
- Miniature hinge for maximum switching capacity, particularly for inductive loads.
- Flame resistant materials (UL94V-0-qualifying) used for all insulation material.
- Quick-connect, screw, and PCB terminals available.
- Standard models are UL, CSA, and TUV approved; VDE/IEC 950 versions are now available. Meet pollution degree 3, Material Group II & III.

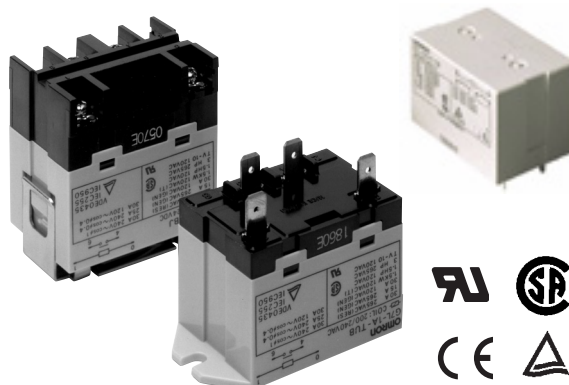

Ordering Information

To Order: Select the part number and add the desired coil voltage rating (e.g., G7L-1A-T-CB-AC100/120).

| Type | Contact form | Model | | |
|--|--------------|------------------------|----------------|--------------|
| | | Quick-connect terminal | Screw terminal | PCB terminal |
| E bracket (see note 1) | SPST-NO | G7L-1A-T-CB | G7L-1A-B-CB | — |
| | DPST-NO | G7L-2A-T-CB | G7L-2A-B-CB | — |
| E bracket (see note 1) (with test button) | SPST-NO | G7L-1A-TJ-CB | G7L-1A-BJ-CB | — |
| | DPST-NO | G7L-2A-TJ-CB | G7L-2A-BJ-CB | — |
| Upper bracket | SPST-NO | G7L-1A-TUB-CB | G7L-1A-BUB-CB | — |
| | DPST-NO | G7L-2A-TUB-CB | G7L-2A-BUB-CB | — |
| Upper bracket (with test button) | SPST-NO | G7L-1A-TUBJ-CB | G7L-1A-BUBJ-CB | — |
| | DPST-NO | G7L-2A-TUBJ-CB | G7L-2A-BUBJ-CB | — |
| PCB mounting | SPST-NO | — | — | G7L-1A-P-CB |
| | DPST-NO | — | — | G7L-2A-P-CB |

- Note:**
1. E bracket or socket must be used for mounting (part number R99-07G5D). Refer to “Accessories” section for options and part numbers.
 2. For VDE approved versions, please consult OMRON.
 3. CE marking is provided only on non-PCB terminal versions.

Model Number Legend

G7L-□□-□□□□
1 2 3 4 5 6

- | | | |
|---|---|--|
| <p>1. Contact form 1A:SPST-NO 2A:DPST-NO</p> <p>2. Terminal shape T:Quick-connect terminals P:PCB terminals B:Screw terminals</p> | <p>3. Mounting construction No symbol:E bracket type UB:Upper bracket type</p> <p>4. Special functions No symbol:Without test button J:With test button</p> | <p>5. 80: VDE approved version (includes UL, CSA and TÜV)</p> <p>6. CB: Class B insulation</p> <p>7. Rated coil voltage</p> |
|---|---|--|

Accessories

Quick-connect Terminals

| Description | Model | | | | Model |
|-------------------------|--------------|-----------|----------|-----------|-----------|
| | Contact form | | | | |
| | SPST-NO | | DPST-NO | | |
| E-brackets | G7L-1A-T | G7L-1A-TJ | G7L-2A-T | G7L-2A-TJ | R99-07G5D |
| Track mounting adaptor | | | | | P7LF-D |
| Front connecting socket | | | | | P7LF-06 |

Note: A socket terminal cover is supplied with the P7LF-06 socket and does not attach directly to the G7L relays. It cannot be purchased separately.

Screw Terminals

| Description | Model | | | | Model |
|------------------------|--------------|-----------|----------|-----------|-----------|
| | Contact form | | | | |
| | SPST-NO | | DPST-NO | | |
| E-brackets | G7L-1A-B | G7L-1A-BJ | G7L-2A-B | G7L-2A-BJ | R99-07G5D |
| Track mounting adaptor | | | | | P7LF-D |
| Terminal Cover | | | | | P7LF-C |

Note: The P7LF-C terminal cover attaches directly to the G7L-B style relays. It is sold separately.

Specifications

Contact Data

| Load | G7L-1A-T, G7L-1A-B | | G7L-2A-T, G7L-2A-B | | G7L-1A-P, G7L-2A-P | |
|-------------------------|---|--------------------------------|------------------------------|--------------------------------|------------------------------|--------------------------------|
| | Resistive load (cosφ = 1) | Inductive load (cosφ = 0.4) | Resistive load (cosφ = 1) | Inductive load (cosφ = 0.4) | Resistive load (cosφ = 1) | Inductive load (cosφ = 0.4) |
| Rated load | 30 A, 220 VAC | 25 A, 220 VAC | | | 20 A, 220 VAC | |
| Contact material | AgSnIn | | | | | |
| Carry current | 30 A | | 25 A | | 20 A | |
| Max. operating voltage | 250 VAC | | | | | |
| Max. operating current | 30 A | | 25 A | | 20 A | |
| Max. switching capacity | 6,600 VA | 5,500 VA | | | 4,400 VA | |
| Min. permissible load | 100 mA, 5 VDC (please inquire for lower minimum rating) | | | | | |

Note: P level: $\lambda_{60} = 0.1 \times 10^{-6}$ operation.

Coil Internal Circuit

DC operating coil

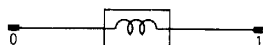

AC operating coil

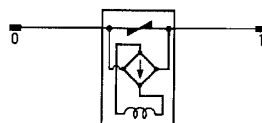

■ Coil Data

AC

| Rated voltage (V) | Rated current (mA) | Resistance (Ω) | Must operate | Must release | Max. voltage | Power consumption |
|-------------------|--------------------|----------------|--------------------|--------------|--------------|-------------------------|
| | | | % of rated voltage | | | |
| 6 | 283 | 18.90 | 75% max. | 15% min. | 110% max. | Approx. 1.70 to 2.50 VA |
| 12 | 142 | 75 | | | | |
| 24 | 71 | 303 | | | | |
| 50 | 34 | 1,310 | | | | |
| 100/120 | 17.00/20.40 | 5,260 | 75 volts | 18 volts | 132 volts | |
| 200/240 | 8.50/10.20 | 21,000 | 150 volts | 36 volts | 264 volts | |

DC

| Rated voltage (V) | Rated current (mA) | Resistance (Ω) | Must operate | Must release | Max. voltage | Power consumption |
|-------------------|--------------------|----------------|--------------------|--------------|--------------|-------------------|
| | | | % of rated voltage | | | |
| 6 | 317 | 18.90 | 75% max. | 15% min. | 110% max. | Approx. 1.90 W |
| 12 | 158 | 75 | | | | |
| 24 | 79 | 303 | | | | |
| 48 | 40 | 1,220 | | | | |
| 100 | 19 | 5,260 | | | | |

Note: 1. The rated current and coil resistance are measured at a coil temperature of 23°C (73°F) with tolerances of +15%/-20% for AC rated current and ±15% for DC coil resistance.

2. Performance characteristic data are measured at a coil temperature of 23°C (73°F).

■ Characteristics

| | | |
|----------------------------------|---|---|
| Contact resistance | | 50 mΩ max. |
| Operate time | | 30 ms max. |
| Release time | | 30 ms max. |
| Max. operating frequency | Mechanical | 1,800 operations/hour |
| | Electrical | 1,800 operations/hour (under rated load) |
| Insulation resistance | | 1,000 MΩ min. (at 500 VDC) |
| Dielectric strength | | 4,000 VAC, min./5,000 VAC typical, 50/60 Hz for 1 minute between coil and contacts |
| | | 2,000 VAC, 50/60 Hz for 1 minute between contacts of same pole |
| | | 2,000 VAC, 50/60 Hz for 1 minute between contacts of different poles (DPST-NO type) |
| Impulse withstand voltage | | Between coil and contact: 10,000 V min./12,000 V typ. (impulse wave used: 1.20 x 50 μs) |
| Vibration | Mechanical durability | 10 to 55 Hz; 1.50 mm (0.06 in) double amplitude |
| | Malfunction durability | 10 to 55 Hz; 1.50 mm (0.06 in) double amplitude |
| Shock | Mechanical durability | 1,000 m/s ² (approx. 100 G) |
| | Malfunction durability | 1,000 m/s ² (approx. 10 G) |
| Life expectancy | Mechanical | 1,000,000 operations min. (at 1,800 operations/hour) |
| | Electrical | 100,000 operations min. (at 1,800 operations/hour under rated load 250,000 ops typical) |
| Ambient temperature | | -25° to 60°C (-13° to 140°F) |
| Humidity | | 35% to 85% RH |
| Weight | Quick-connect terminal type: approx. 90 g (3.17 oz) | |
| | PCB terminal type: approx. 100 g (3.52 oz) | |
| | Screw terminal type: approx. 120 g (4.23 oz) | |

Note: Data shown are of initial value.

Characteristic Data

Maximum switching capacity

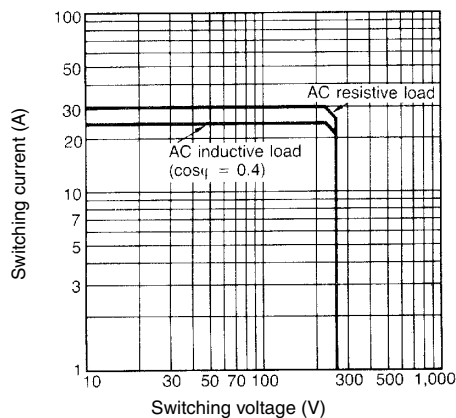

Electrical service life

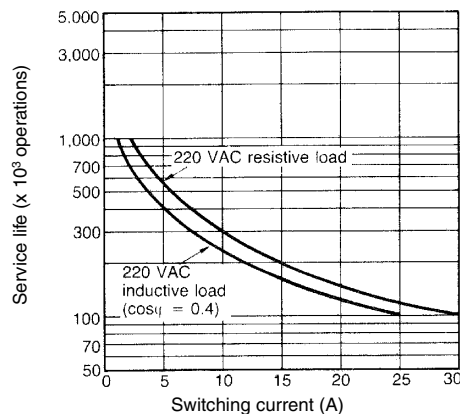

Dimensions

Unit: mm (inch)

Relays

G7L-1A-T (E Bracket Attached)*

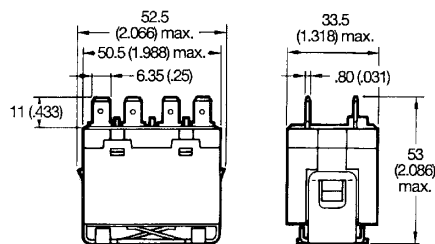

Terminal arrangement/ Internal connections (Top view)

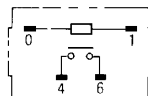

Mounting holes (Bottom view)

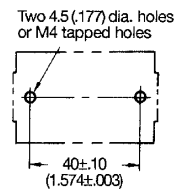

G7L-2A-T (E Bracket Attached)*

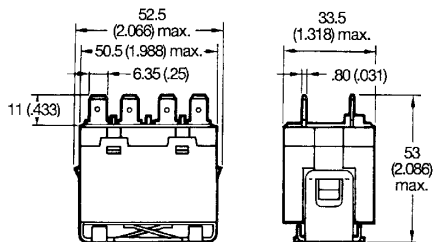

Terminal arrangement/ Internal connections (Top view)

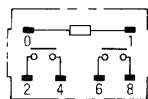

Mounting holes (Bottom view)

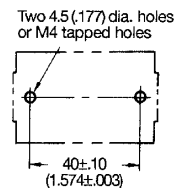

* E bracket must be ordered separately.

**G7L-1A-TJ
(E Bracket Attached)***

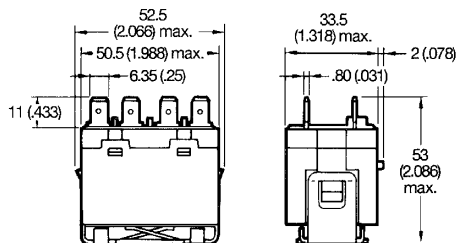

**Terminal arrangement/
Internal connections
(Top view)**

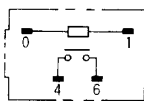

**Mounting holes
(Bottom view)**

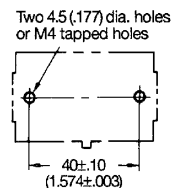

**G7L-2A-TJ
(E Bracket Attached)***

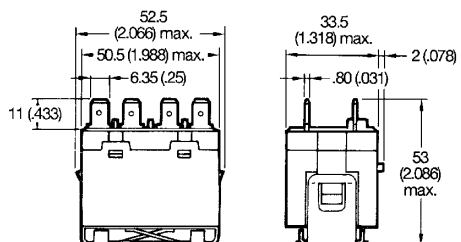

**Terminal arrangement/
Internal connections
(Top view)**

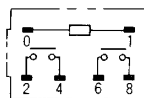

**Mounting holes
(Bottom view)**

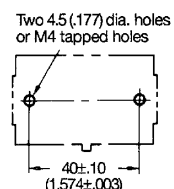

G7L-1A-TUB

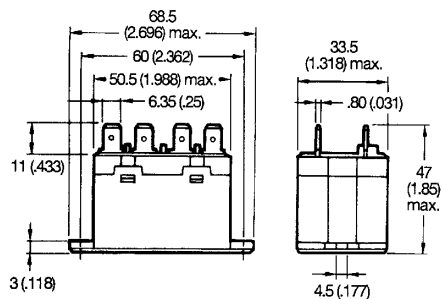

**Terminal arrangement/
Internal connections
(Top view)**

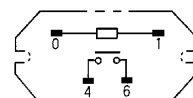

**Mounting holes
(Bottom view)**

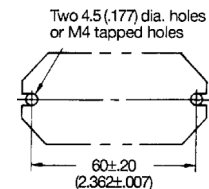

G7L-2A-TUB

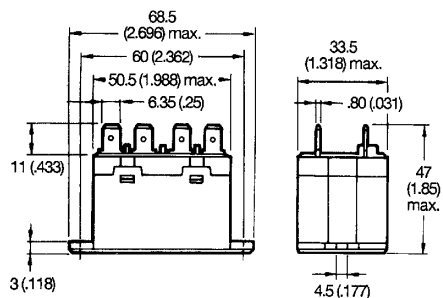

**Terminal arrangement/
Internal connections
(Top view)**

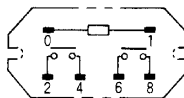

**Mounting holes
(Bottom view)**

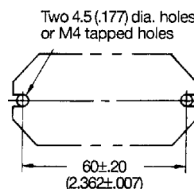

*E bracket must be ordered separately.

Unit: mm (inch)

G7L-1A-TUBJ

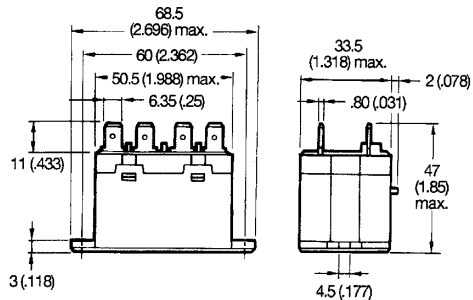

**Terminal arrangement/
Internal connections
(Top view)**

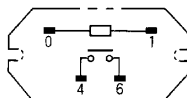

**Mounting holes
(Bottom view)**

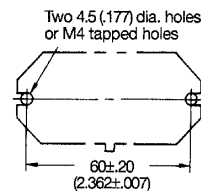

G7L-2A-TUBJ

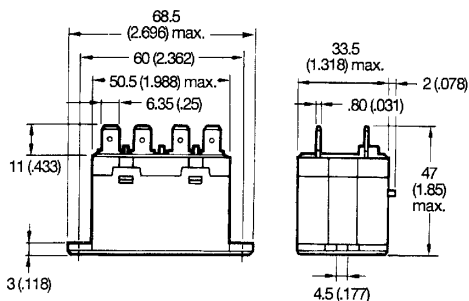

**Terminal arrangement/
Internal connections
(Top view)**

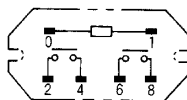

**Mounting holes
(Bottom view)**

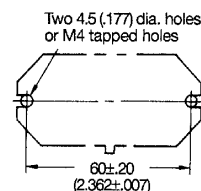

**G7L-1A-B
(E bracket Attached)***

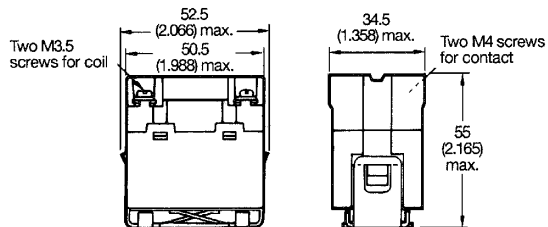

**Terminal arrangement/
Internal connections
(Top view)**

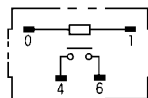

**Mounting holes
(Bottom view)**

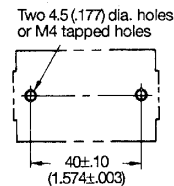

**G7L-2A-B
(E bracket Attached)***

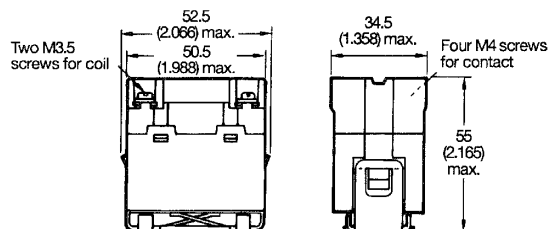

**Terminal arrangement/
Internal connections
(Top view)**

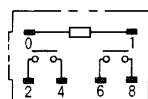

**Mounting holes
(Bottom view)**

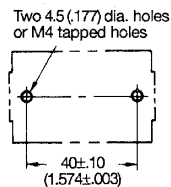

* E bracket must be ordered separately.

G7L-1A-BJ
(E bracket Attached)*

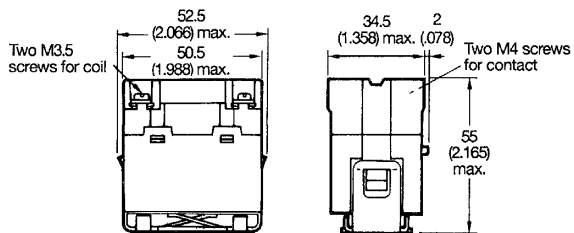

**Terminal arrangement/
Internal connections**
(Top view)

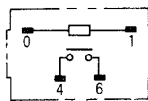

Mounting holes
(Bottom view)

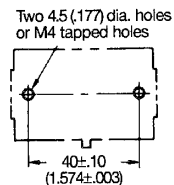

G7L-2A-BJ
(E bracket Attached)*

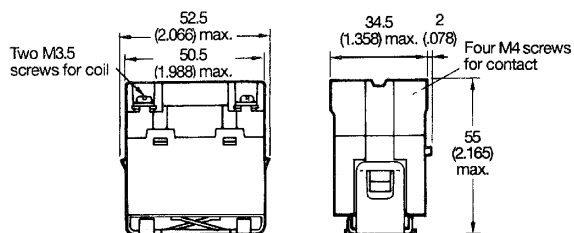

**Terminal arrangement/
Internal connections**
(Top view)

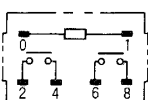

Mounting holes
(Bottom view)

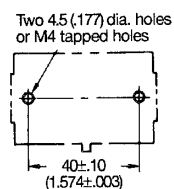

G7L-1A-BUB

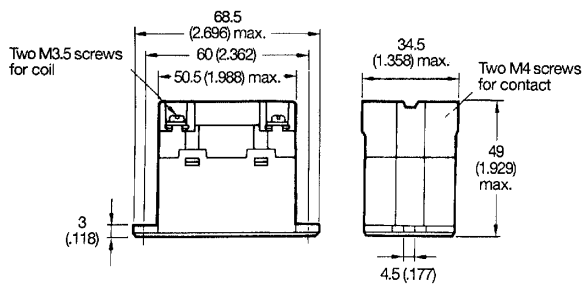

**Terminal arrangement/
Internal connections**
(Top view)

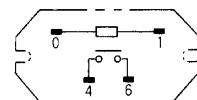

Mounting holes
(Bottom view)

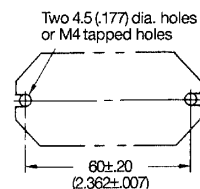

G7L-2A-BUB

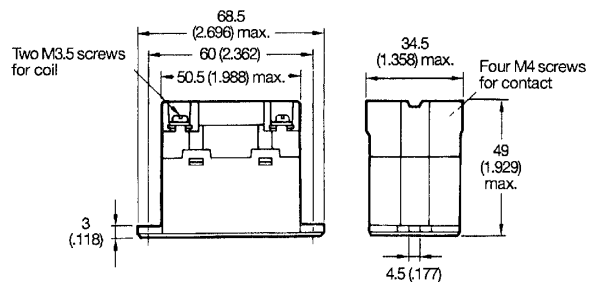

**Terminal arrangement/
Internal connections**
(Top view)

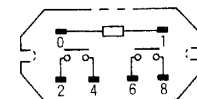

Mounting holes
(Bottom view)

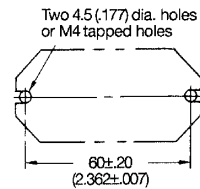

* E bracket must be ordered separately.

Unit: mm (inch)

G7L-1A-BUBJ

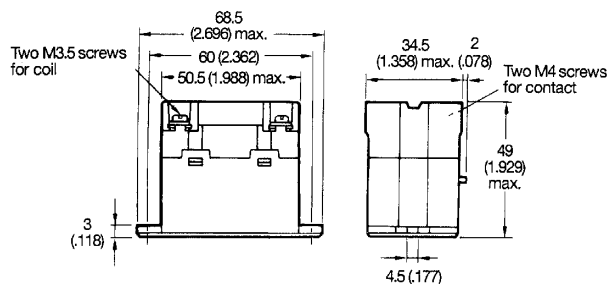

**Terminal arrangement/
Internal connections
(Top view)**

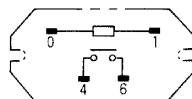

**Mounting holes
(Bottom view)**

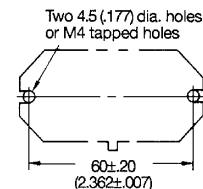

G7L-2A-BUBJ

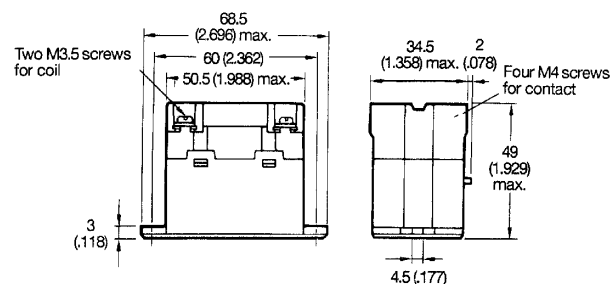

**Terminal arrangement/
Internal connections
(Top view)**

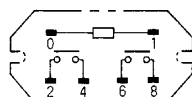

**Mounting holes
(Bottom view)**

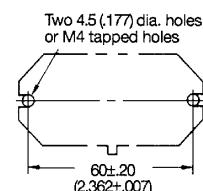

G7L-1A-P

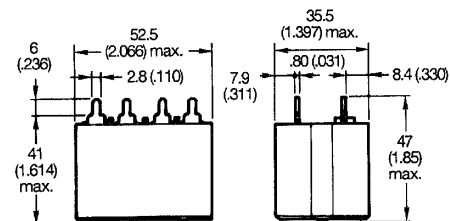

**Terminal arrangement/
Internal connections
(Top view)**

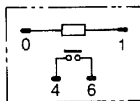

**Mounting holes
(Bottom view)**

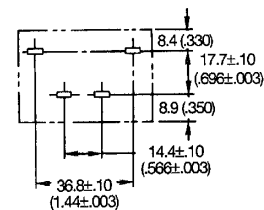

G7L-2A-P

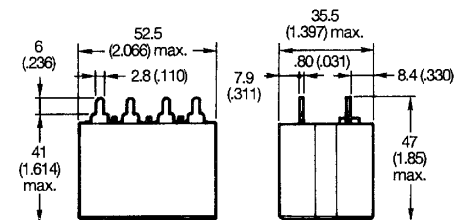

**Terminal arrangement/
Internal connections
(Top view)**

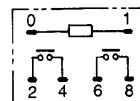

**Mounting holes
(Bottom view)**

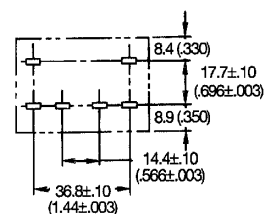

Accessories

E bracket R99-07G5D

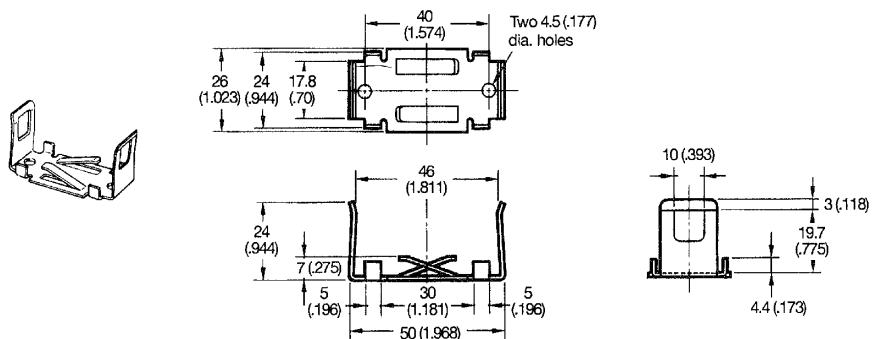

Mounting holes (Bottom view)

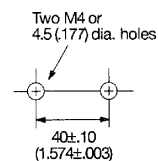

Adaptor P7LF-D

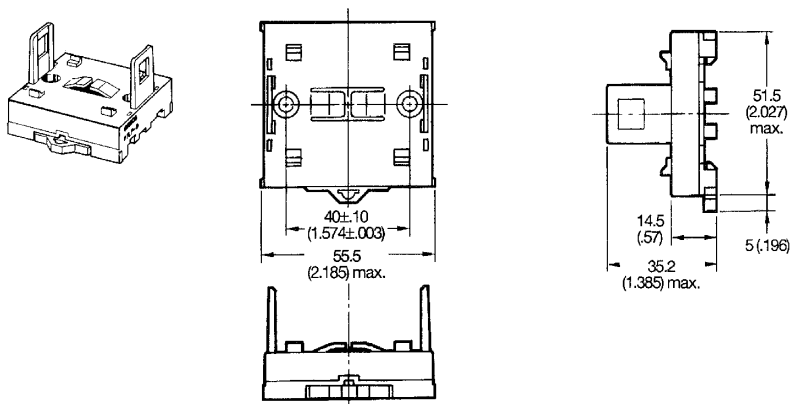

Mounting holes (Bottom view)

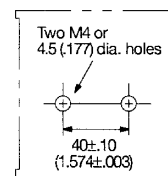

Front connecting socket P7LF-06

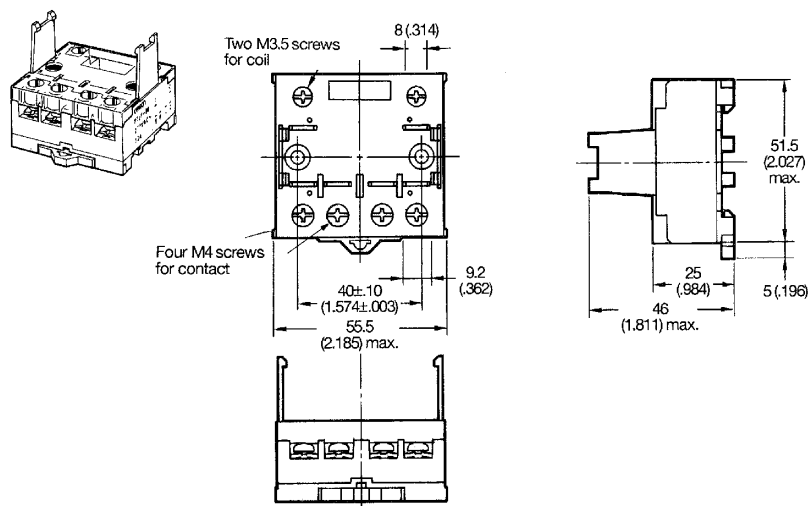

Mounting holes (Bottom view)

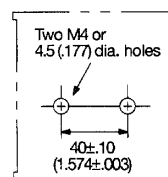

- Note:**
- To protect against electric shock, a socket terminal cover is supplied with the P7LF-06 socket.
 - The P7LF-06 is panel or track mountable.

Unit: mm (inch)

Cover
P7LF-C

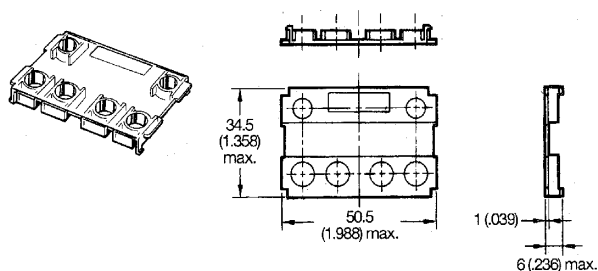

Note: P7LF-C cover attaches directly to G7L-B style relays. To protect against electric shock, use the P7LF-C on G7L-B terminals.

Mounting track

PFP-100N, PFP-50N
(Conforming to EN 50022)

PFP-100N2
(Conforming to EN 50022)

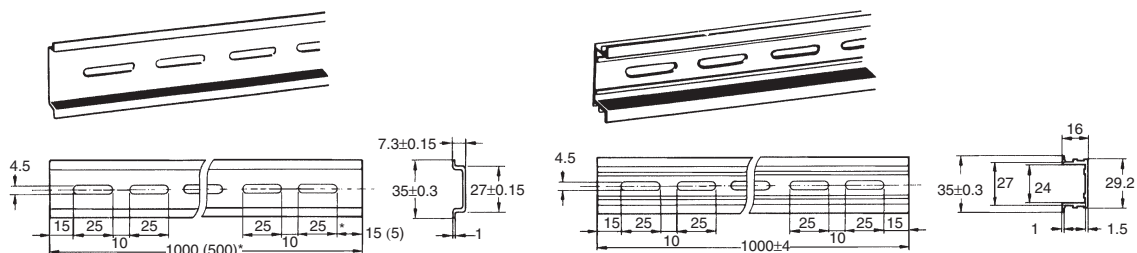

* The figure in parenthesis is for PFP-50N.

Note: 1. It is recommended that a panel thickness of 1.60 to 2.00 mm (0.06 to 0.08 in) be used.

2. L = Length

PFP-100N L = 1 m (39.00 in)

PFP-50N L = 50 cm (19.60 in)

PFP-100N2 L = 1 m (39.00 in)

End plate

PFP-M

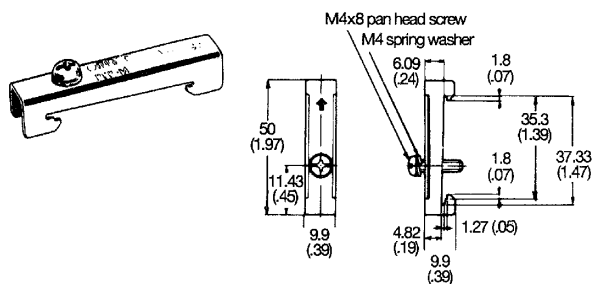

Spacer

PFP-S

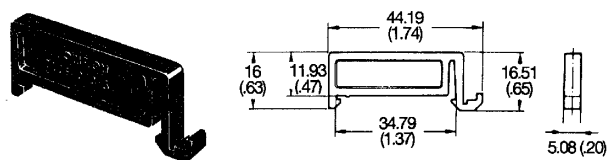

■ Approvals

UL Recognized (File No. E41643) / CSA Certified (File No. LR35535) - - Ambient Temp. = 40°C

| Type | Contact form | Terminal type | Contact ratings |
|--|--------------|---------------|---|
| G7L-1A-T-CB G7L-1A-TJ-CB G7L-1A-TUB-CB G7L-1A-TUBJ-CB | SPST-NO | Quick-connect | 30 A, 277 VAC, General Use, 100,000 ops 1.5 kW, 120 VAC, Tungsten, 6,000 ops 1.5 HP, 120 VAC, 6,000 ops 3 HP, 277 VAC, 6,000 ops |
| G7L-1A-B-CB G7L-1A-BJ-CB G7L-1A-BUB-CB G7L-1A-BUBJ-CB | | Screw | 20 FLA/120 LRA, 120 VAC, 30,000 ops 17 FLA/102 LRA, 265 VAC, 30,000 ops TV-10, 120 VAC, 25,000 ops |
| G7L-1A-P-CB | | PCB | |
| G7L-2A-T-CB G7L-2A-TJ-CB G7L-2A-TUB-CB G7L-2A-TUBJ-CB | DPST-NO | Quick-connect | |
| G7L-2A-B-CB G7L-2A-BJ-CB G7L-2A-BUB-CB G7L-2A-BUBJ-CB | | Screw | |
| G7L-2A-P-CB | | PCB | |

Note: Contact Omron for actual ratings marked on G7L relays

TÜV (File No. R9251551)

| Type | Contact form | Coil ratings | Terminal type | Contact ratings |
|--|--------------|---|---------------|---|
| G7L-1A-T-CB G7L-1A-TJ-CB G7L-1A-TUB-CB G7L-1A-TUBJ-CB | SPST-NO | 6, 12, 24, 48, 100, 110, 200, 220 VDC | Quick-connect | 25 A, 240 VAC, (cosφ = 1) 25 A, 240 VAC, (cosφ = 0.4) |
| G7L-1A-B-CB G7L-1A-BJ-CB G7L-1A-BUB-CB G7L-1A-BUBJ-CB | | | Screw | 30 A, 240 VAC, (cosφ = 1) 25 A, 240 VAC, (cosφ = 0.4) 30 A, 240 VAC, (cosφ = 0.4) |
| G7L-1A-P-CB | | | PCB | 20 A, 240 VAC, (cosφ = 1) 20 A, 240 VAC, (cosφ = 0.4) |
| G7L-2A-T-CB G7L-2A-TJ-CB G7L-2A-TUB-CB G7L-2A-TUBJ-CB | DPST-NO | 12, 24, 50, 100/120, 200/240 VAC | Quick-connect | 25 A, 240 VAC, (cosφ = 1) 25 A, 240 VAC, (cosφ = 0.4) |
| G7L-2A-B-CB G7L-2A-BJ-CB G7L-2A-BUB-CB G7L-2A-BUBJ-CB | | | Screw | 25 A, 240 VAC, (cosφ = 1) 25 A, 240 VAC, (cosφ = 0.4) |
| G7L-2A-P-CB | | | PCB | 20 A, 240 VAC, (cosφ = 1) 20 A, 240 VAC, (cosφ = 0.4) |

VDE recognized type (Licence no. 1530 UG)

Note: 1. Please consult OMRON for details of VDE approvals.

2. The G7L relay conforms to the following standards:

Electrical safety: DIN IEC 255 Teil 1-00/DIN VDE 0435 Teil 201/05. 83
DIN VDE 0435 Teil 201 A1/05. 90
DIN IEC 255 Teil 0-20/DIN VDE 0435 Teil 120/10. 81
DIN EN 60 950/VDE 0805/11. 93

EMC: prEN 50082-2, EN 55022

- The rated values approved by each of the safety standards (e.g., UL and CSA) may be different from the performance characteristics individually defined in this catalog.
- In the interest of product improvement, specifications are subject to change.
- Suffix T130 rated at 130°C
- Pollution degree 3, Material Group II & III.
- CE marking is provide only on non-PCB terminal versions.

Precautions

■ Handling

- To preserve initial performance, do not drop or otherwise subject the power relay to shock.
- The case is not designed to be removed during normal handling and operation. Doing so may affect performance.
- Use the power relay in a dry environment free from excessive dust, SO₂, H₂S, or organic gas.
- Do not allow a voltage greater than the maximum allowable coil voltage to be applied continuously.
- Do not use the power relay outside of specified voltages and currents.
- Do not allow the ambient operating temperature to exceed the specified limit.

■ Installation

- Although there are not specific limits on the installation site, it should be as dry and dust-free as possible.
- PCB terminal-equipped relays weigh approximately 100 g. Be sure that the PCB is strong enough to support them. We recommend dual-side through-hole PCBs to reduce solder cracking from heat stress.
- Quick-connect terminals can be connected to fast on receptacle #250 and positive-lock connectors.
- Allow suitable slack on leads when wiring, and do not subject the terminals to excessive force.

■ Cleaning PCB Terminals

- PCB terminals have semi-sealed construction which prevents flux from entering the relay base. It is recommended that the user should apply a tape seal over the vent hole prior to wave soldering or cleaning. The tape should then be removed after processing.

■ Applications

- Compressors for package air conditioners and heater switching controllers
- Switching controllers for power tools or motors
- Power controllers for water heaters
- Power controllers for dryers
- Lamp control, motor drivers, and power supply switching in copy machines, facsimiles, and other OA equipment
- Lighting controllers
- Power controllers for packers or food processing equipment
- Magnetron control in microwaves

■ Operating Coil

- As a rule, either a battery or a DC power supply with a maximum 5% ripple is used for the operating voltage for DC relays. Before using a rectified AC supply, confirm that the ripple is not greater than 5%. Ripple greater than this can lead to variations in the operating and reset voltages.

As excessive ripple can generate beats, the insertion of a smoothing capacitor is recommended as shown below.

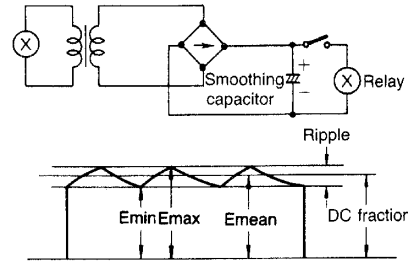

$$\% \text{ of ripple} = \frac{E_{\text{max}} - E_{\text{min}}}{E_{\text{mean}}} \times 100$$

E max: Max. ripple
 E min: Min. ripple
 E mean: Mean DC value

- When driving a transistor, check the leakage current and connect a bleeder resistor if necessary.
- Momentary voltage drops on coil input voltage should not exceed one second duration after contact mating with no shock or vibration.

A large grid of graph paper for taking notes, consisting of 20 columns and 30 rows of small squares.

All sales are subject to Omron Electronic Components LLC standard terms and conditions of sale, which can be found at http://www.components.omron.com/components/web/webfiles.nsf/sales_terms.html

ALL DIMENSIONS SHOWN ARE IN MILLIMETERS.

To convert millimeters into inches, multiply by 0.03937. To convert grams into ounces, multiply by 0.03527.

OMRON[®]

**OMRON ELECTRONIC
COMPONENTS LLC**

55 E. Commerce Drive, Suite B
Schaumburg, IL 60173

847-882-2288

OMRON ON-LINE

Global - <http://www.omron.com>

USA - <http://www.components.omron.com>

Cat. No. X301-E-1b

09/11

Specifications subject to change without notice

Printed in USA

Компания «Life Electronics» занимается поставками электронных компонентов импортного и отечественного производства от производителей и со складов крупных дистрибьюторов Европы, Америки и Азии.

С конца 2013 года компания активно расширяет линейку поставок компонентов по направлению коаксиальный кабель, кварцевые генераторы и конденсаторы (керамические, пленочные, электролитические), за счёт заключения дистрибьюторских договоров

Мы предлагаем:

- Конкурентоспособные цены и скидки постоянным клиентам.
- Специальные условия для постоянных клиентов.
- Подбор аналогов.
- Поставку компонентов в любых объемах, удовлетворяющих вашим потребностям.
- Приемлемые сроки поставки, возможна ускоренная поставка.
- Доставку товара в любую точку России и стран СНГ.
- Комплексную поставку.
- Работу по проектам и поставку образцов.
- Формирование склада под заказчика.
- Сертификаты соответствия на поставляемую продукцию (по желанию клиента).
- Тестирование поставляемой продукции.
- Поставку компонентов, требующих военную и космическую приемку.
- Входной контроль качества.
- Наличие сертификата ISO.

В составе нашей компании организован Конструкторский отдел, призванный помогать разработчикам, и инженерам.

Конструкторский отдел помогает осуществить:

- Регистрацию проекта у производителя компонентов.
- Техническую поддержку проекта.
- Защиту от снятия компонента с производства.
- Оценку стоимости проекта по компонентам.
- Изготовление тестовой платы монтаж и пусконаладочные работы.



Тел: +7 (812) 336 43 04 (многоканальный)

Email: org@lifeelectronics.ru