

# Bourns® Transient Blocking Unit (TBU™)

## High-Speed Electronic Current Limiter Protection



### BACKGROUND

#### The Surge Threat

Surge protection is the process of protecting electronic systems or equipment from voltages and currents which are outside their safe operating limits. These surge voltages and currents can be generated by short circuits, lightning or faults from a power system and usually enter the electronic system along inter-equipment wiring. The surges may be galvanically coupled into the system as in the case of a direct lightning strike, through an inadvertent connection of the power system to the wiring, or as a result of an earth potential rise. They may be capacitively coupled into the system which may occur when a data system is used in the vicinity of a high voltage power line. They may be inductively coupled into the system as may occur if the wiring is run in parallel with large currents running in a power circuit feeding a high power motor.

The size and waveform of the transients which can occur within a system are many and varied. In general, however, the following will hold true:

**1. Lightning** - Although direct strike lightning current can potentially generate transients in the millions of volts and tens of thousands of amps, electronic equipment is rarely exposed to surges of this magnitude. The greatest exposure in telecommunication systems is through inter-connecting telecommunication transmission lines. These lines can only carry voltages up to 5 kV and currents of the order of 1 kA. Therefore, for the vast majority of instances where the chance of a lightning strike directly to the equipment is low, 5 kV and 1 kA is the limit of the direct strike or inductively generated surges.

**2. Power Induction** - Although power induction voltages can be quite high in voltage and current, they are often limited in duration. These voltages are caused by faults on the power system which couple into the system (usually inductively as a consequence of the surge causing a very large fault current). In virtually all modern power transmission systems, these faults are very quickly terminated by circuit breaker and re-closer equipment. This can occur in as short as a couple of cycles of power frequency voltage and rarely takes longer than a second. These transients are typically modeled as a 600 V<sub>rms</sub> waveform lasting up to a second.

**3. Power Cross** - Alternatively, power cross voltages are low voltage events but the exposure can occur for very long durations. They are often caused by maintenance error or cabling faults and can result in moderate currents (<25 A) flowing for a long period of time (15 minutes, for example). They are predominately at mains power supply voltage levels (100-240 V<sub>rms</sub>).

**4. Earth Potential Rise (EPR)** - EPR can be categorized in two forms: 1) as a result of power system faults and 2) lightning discharges. In normal industry, where fault currents from the power system are limited in magnitude by fuses and circuit breakers, power system EPR is not usually a considerable risk. EPR only becomes a significant risk when power earthing systems are significantly below standard or where high power transmission systems are used such as at power generation and distribution facilities, within the high power industry, and in the vicinity



## BACKGROUND

of electrical traction systems (electric rail). In such circumstances, this type of surge needs to be carefully managed and expert predictions need to be made of the risk and size of events. Lightning EPR can only result from a direct strike to the building housing the equipment or in its immediate vicinity. Such events are uncommon, unless the installation is particularly vulnerable due to location or extreme height (e.g. cellular phone base-station antennae). The equipment exposure as a result of EPR can be very high, and at high earth resistance locations, may become a significant portion of the lightning current.

5. All other forms of transients tend to be lower energy forms not posing any additional risk to equipment if protection has been suitably designed for the events detailed above.

### Conventional Protection

There are two primary methods for implementing protection against surge threats, namely, blocking the surge or diverting (shunting) the surge. Nearly all conventional protection schemes used today are based on shunting architectures because of two fundamental assumptions:

- 1) Inexpensive devices exist which shunt faults of hundreds of amperes and thousands of volts.
- 2) Inexpensive devices which block faults of hundreds of amperes and thousands of volts are rare, if they exist at all.

Therefore, conventional protection relies on the primary form of protection being shunt devices, which divert current. However, shunt devices have limitations which affect their ability to protect electronic equipment by themselves. Electronic equipment can be damaged by voltages in the tens of volts and currents in the hundreds of milliamperes if they persist for any significant length of time (more than microseconds). Therefore, equipment protection requires a shunt protector that: 1) can react fast enough to allow less than these values from reaching the equipment, and 2) can subsequently short circuit and protect the interface from a surge which may peak on the order of 1000 A. Considering that the surge may develop in a few microseconds, this is quite a difficult task.

Some primary protective devices such as semiconductor-based devices are fast enough to react in time; however these devices tend to have limited current handling capability. Also, semiconductor devices rated for the primary protection task tend to capacitively load a circuit (due to their physically large size) resulting in bandwidth limitations. Non-semiconductor surge protectors, such as the Gas Discharge Tube (GDT), do not capacitively load circuits and can handle very large currents (tens of kilo-amperes); however, these devices are slower to react and may not keep the voltages sufficiently low to provide successful protection by themselves. Therefore, conventional protection must be based on a number of stages of such devices. These stages typically start with a GDT as the primary protector for its current handling capability, followed by a semiconductor thyristor protector for speed – the secondary protector.



## BACKGROUND

### Coordination Protection

When GDT and thyristor shunt protectors are used as primary and secondary protectors, the protection coordination between them is complicated in practice. When a surge event occurs, the fast secondary protector will act to limit voltage within the system first (due to its speed). Often this protector will be rated to keep the circuit voltages quite low in order to protect the equipment. Thus, its action can prevent the high energy primary protector (GDT), which requires a higher voltage to operate, from working. In this circumstance, damage is likely to occur to the secondary protector before the GDT operates.

This problem is solved by the complex process of inter-stage coordination. Coordination is the process of placing impedance between the primary and secondary protectors to ensure that sufficient voltage is generated across the primary protector, resulting from current flowing in the secondary protector, to trigger the primary device. Coordination is engineered properly when the primary protector operates after the secondary protector operates, yet before the secondary protector is damaged. The coordinating impedance can be resistive, capacitive, inductive, non-linear or a combination of all of these; proper selection is critical.

Large resistance is the easiest choice to ensure that only a small current in the secondary device causes a significant voltage across the primary device causing it to operate. However, large resistance introduces considerable loss within the data transmission path which is often unacceptable. Capacitance and inductance are also

useful, but these impedances are frequency related and so circuits coordinated with such will work only for a band of surge frequencies. Non-linear resistance can also be used to create different coordinating arrangements based on the duration of the surge - low level surges for example which last a long time causing the coordinating impedance to change to a high resistance state choking further current flow and triggering the primary protector (the basis of operation of the PTC). A typical conventional POTS (Plain Old Telephone System) protection design with inter-stage protection is provided in Figure 1.

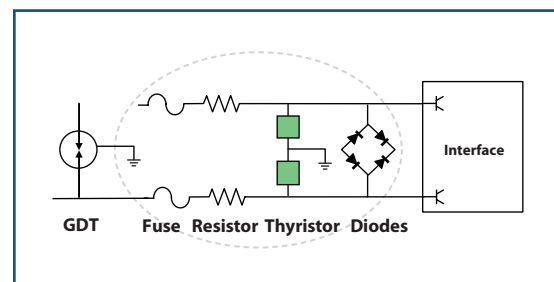

Figure 1. Conventional Protection - Circled parts indicating the secondary protection and the coordinating impedances.



## BACKGROUND

In reality though, the process of selecting the best coordinating arrangement requires an in depth understanding of:

1. The surge threat;
2. The performance of all the protective components' shunting and coordinating (voltage/current/power/energy/time) characteristics in addition to the conditions under which they trigger or not;
3. The interface's resistibility to voltages and currents (voltage/current/time);
4. The transmission system specifications (bandwidth, maximum allowable loss); and
5. The interaction between multi-stage protection circuits.

And therein is the problem. The time and frequency dependent aspects of the coordination problem make these circuits difficult to design with any degree of certainty. Consequently, testing must be used to assess the performance of a protection design within a specific system - a requirement which has spurred the vast array of testing and design standards within the marketplace. In addition, virtually all completed designs have some inherent weaknesses – e.g. a weakness to sneak currents, a weakness to high energy surges, or a weakness to surges of a particular frequency or at a particular rate of repetition - and these weaknesses can cause field failures, incurrence of replacement costs and lack of reliability.



## IDEAL PROTECTION

Recall that secondary protection is only required to prevent the let-through energy of the primary protector (the energy of the surge which gets past the primary protector) from damaging the load.

By definition, the peak open circuit voltage of the let-through energy past the primary protector must be smaller than that of the initiating surge – otherwise by definition, the primary protector is providing no protection at all. Therefore, a secondary protector which blocks rather than diverts this lower, manageable and largely predictable voltage would be very effective.

The requirements for this ideal blocking device are self-evident:

1. As the device needs to block the let-through energy of the primary protector, it must be a series component (in series with the transmission line), located just after the primary protector. As a series component, the device will react to the current through the device rather than voltage across the interface.
2. This series device should have a predictable, stable and low trigger current (current at which the device changes between its conductive and non-conductive state) to provide effective protection for sensitive downstream equipment.
3. It should be very fast acting (less than 10 nanoseconds) to protect equipment from surges which rise to 5 kV in a microsecond - as do direct lightning strikes or lightning EPR;

4. It should have low impedance (resistive, capacitive and inductive) so that it does not effect normal circuit operation;

5. In the blocking mode, it should have very high impedance so that it does not dissipate significant energy during long duration surges;

6. It should reset after the surge to reinstate the system and continue to allow normal system operation.

In addition, for practical and economic reasons it should be small in size and low in cost. The Transient Blocking Unit (TBU) protector meets these requirements.

## HOW THE TBU DEVICE WORKS

### General

TBU device protection takes a different approach to that of conventional protection. It is still based broadly on the assumption that a primary shunt protector is needed as surge currents are more manageable than surge voltages. However, it effectively replaces the need for secondary protection and coordination considerations, with one component. The TBU device was developed to meet the requirements of the ideal protector described on the previous page. In order to understand the operation, it is useful to picture the TBU device as having a current limiting functional block and a voltage disconnect functional block.

The TBU device responds to both overcurrent and overvoltage faults as described in the following paragraphs.

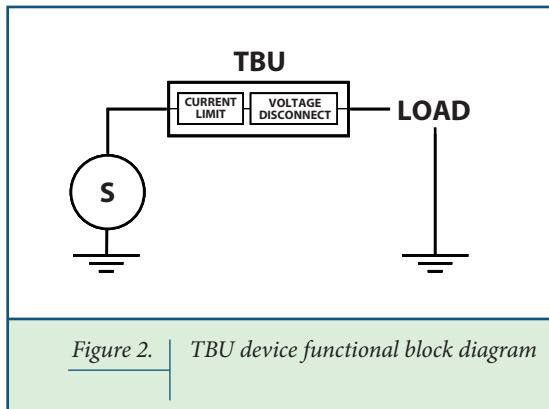

### Overcurrent Faults

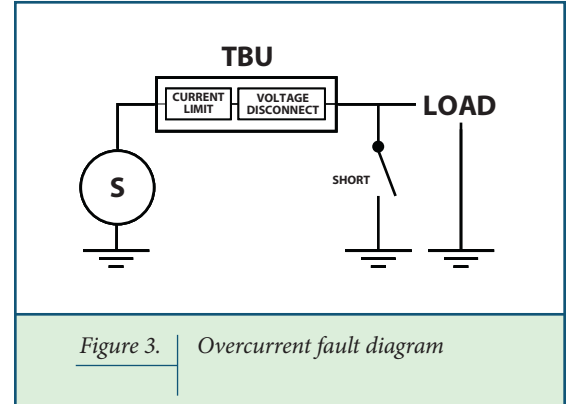

A short circuit event occurring at time 1 (see Figure 4), raises the current to the current limiting level of  $I_{out}$  time 2 (~10 nanoseconds). At this point, the voltage disconnect portion of the circuit operates and by time 3 (~1 microsecond), the load is disconnected from the surge. During the remainder of the surge (time 4), the TBU device remains in the protected state of very low current and voltage at the load.

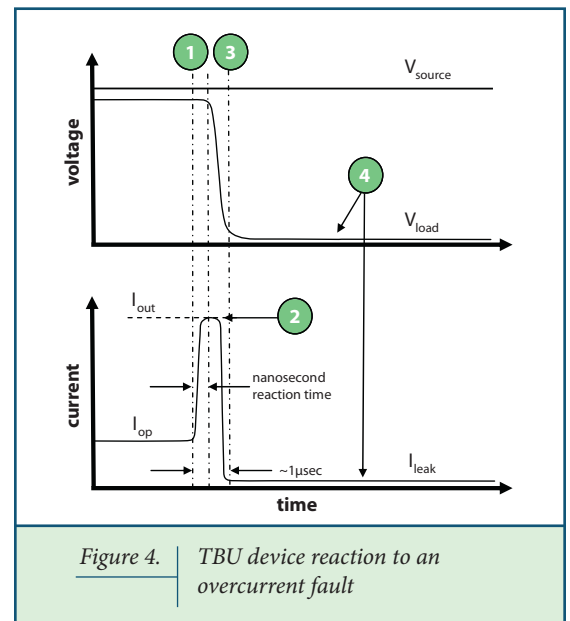



## HOW THE TBU DEVICE WORKS

### Overvoltage Faults

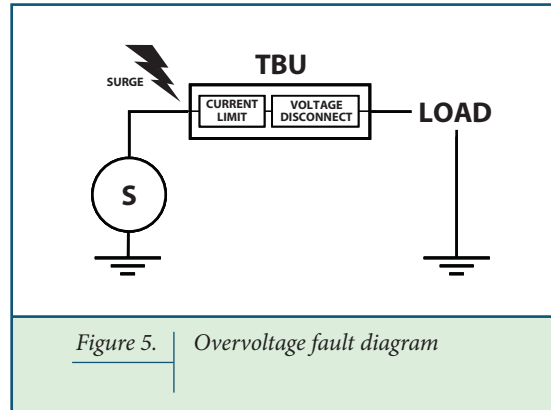

Figure 5. Overvoltage fault diagram

A lightning or power cross event at time 1 (see figure 6), raises the voltage and current until the current limiting portion of the circuit limits current to the level of  $I_{out}$  time 2 (~10 nanoseconds). At this point, the voltage disconnect portion of the circuit operates and by time 3 (~1 microsecond), the load is disconnected from the surge. During the remainder of the surge (time 4), the TBU device remains in the protected state of very low current and voltage at the load.

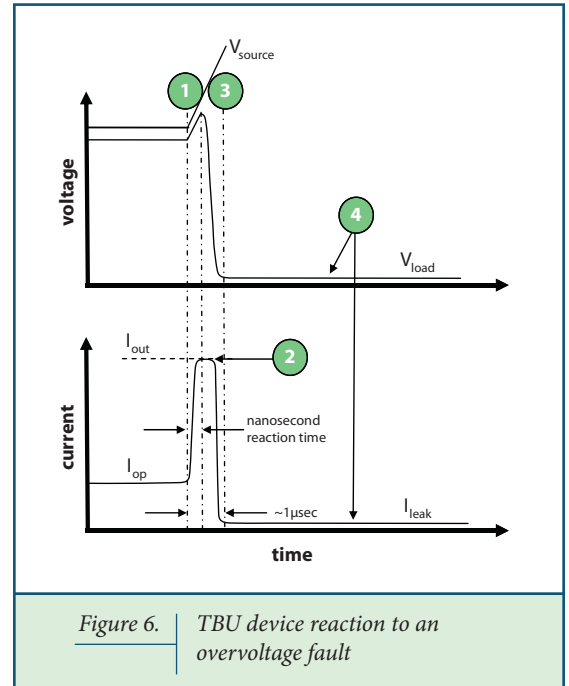

Figure 6. TBU device reaction to an overvoltage fault



## TBU DEVICE PERFORMANCE

### Impulsive Surge Test Results

The following test results show the TBU device's response to a fast-rising lightning impulse. The test was done using a 10/1000  $\mu$ s impulse generator as a voltage source with the peak voltage set to 1200 V. The test was conducted without shunt devices (i.e. with no GDT, thyristor or MOV).

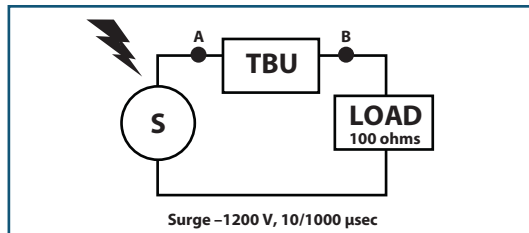

Figure 7. Lightning impulse test circuit

Figure 8 shows the input waveform on the lower trace in red (voltage on the TBU device input,  $V_A$ ) and the voltage at the TBU device output on the upper trace in blue ( $V_B$ ). The TBU device current limited to  $\sim$ 280 ma (i.e. 28 V across the 100  $\Omega$  resistor) and then disconnected the load throughout the remainder of the surge. The peak voltage across the TBU device was  $\sim$ 1200 V, just after it triggered to protect the load. The device automatically reset after the surge ended.

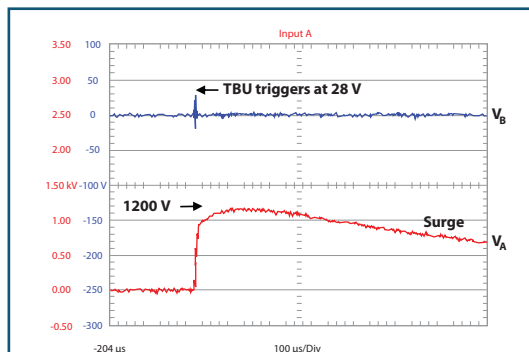

Figure 8. Impulse test of TBU device

### AC Overvoltage

The following tests show TBU device performance against an AC overvoltage.

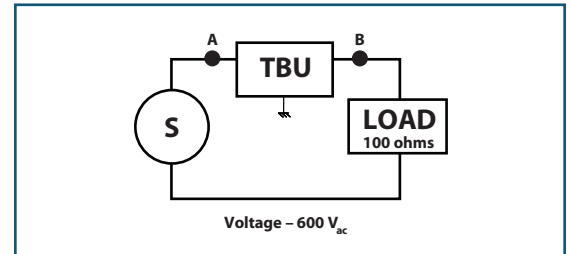

Figure 9. AC overvoltage test circuit

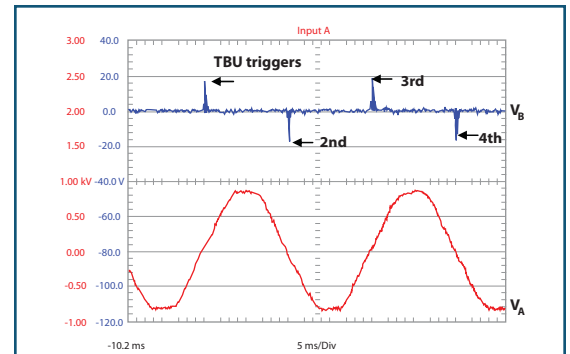

Figure 10. TBU device blocking a 600  $V_{rms}$  power cross

At the onset of the surge, the TBU device reacted to the increasing current and triggered to protect the load. The TBU device remained in the protected state throughout the remainder of the high voltage cycle. At each surge zero-crossing, the TBU device reset in a microsecond, and then retriggered to protect the load for each of the remaining cycles of the test. Once the fault was removed, the device reset to its normal, low impedance state.





**SUMMARY**

**Blocking, Not Shunting**

In designing circuit protection, conventional wisdom has held that blocking devices that can cost-effectively block real world surges do not exist. As a result, most circuit protection schemes today rely on multiple shunt devices to protect against surges. However, the currents that can occur in such surges can be significant (hundreds of amps) and they can last a very long time (in the order of one second to hours). This high current coupled with significant duration places a very large stress on circuits protected by all types of shunt protective devices including GDTs, MOVs and thyristors.

However, the Transient Blocking Unit (TBU™) Electronic Current Limiter has proven the conventional wisdom to be outdated. As a consequence, it is now possible to effectively block surges and prevent sensitive load electronics from experiencing high levels of energy during surge events.

**Conclusion**

The TBU device provides blocking protection for both power cross and lightning. Benefits of the TBU device include overvoltage and overcurrent protection in one device, extremely high speed performance, high blocking voltages and currents, precise output current and voltage limiting, very high bandwidth, and a small size. These advantages result in a protection device which exceeds Telcordia GR-1089 and ITU K.20/K.21 requirements, provides automatic protection coordination, and is GHz data rate compatible all within a minimum of printed circuit board area.

The TBU protector provides the circuit protection design community with a simple, superior protection device.

For more information on TBU devices and other circuit protection products from Bourns, please visit

[www.bourns.com](http://www.bourns.com)

COPYRIGHT © 2009 • BOURNS, INC. 03/09 e/FU0936  
 "TBU" is a trademark of Bourns, Inc.  
 "Bourns" is a registered trademark of Bourns, Inc. in the U.S. and other countries.

Компания «Life Electronics» занимается поставками электронных компонентов импортного и отечественного производства от производителей и со складов крупных дистрибьюторов Европы, Америки и Азии.

С конца 2013 года компания активно расширяет линейку поставок компонентов по направлению коаксиальный кабель, кварцевые генераторы и конденсаторы (керамические, пленочные, электролитические), за счёт заключения дистрибьюторских договоров

Мы предлагаем:

- Конкурентоспособные цены и скидки постоянным клиентам.
- Специальные условия для постоянных клиентов.
- Подбор аналогов.
- Поставку компонентов в любых объемах, удовлетворяющих вашим потребностям.
- Приемлемые сроки поставки, возможна ускоренная поставка.
- Доставку товара в любую точку России и стран СНГ.
- Комплексную поставку.
- Работу по проектам и поставку образцов.
- Формирование склада под заказчика.
- Сертификаты соответствия на поставляемую продукцию (по желанию клиента).
- Тестирование поставляемой продукции.
- Поставку компонентов, требующих военную и космическую приемку.
- Входной контроль качества.
- Наличие сертификата ISO.

В составе нашей компании организован Конструкторский отдел, призванный помогать разработчикам, и инженерам.

Конструкторский отдел помогает осуществить:

- Регистрацию проекта у производителя компонентов.
- Техническую поддержку проекта.
- Защиту от снятия компонента с производства.
- Оценку стоимости проекта по компонентам.
- Изготовление тестовой платы монтаж и пусконаладочные работы.



Тел: +7 (812) 336 43 04 (многоканальный)  
Email: [org@lifeelectronics.ru](mailto:org@lifeelectronics.ru)