

Photomicrosensor (Transmissive) EE-SX3162/3163/3164-P Series EE-SX4162/4163/4164-P Series EE-5002 1M

Slot / Connector Type

- Photo IC output (Dark-ON / Light ON)
- Connector with strong lock manufactured by JST. Mates with GHR-03.
- Mounted with M2 screws
- Models available for 5-V or 12-V power supply.
- Zener diode mounted for greater noise immunity (EE-SX3162-P1-Z and EE-SX4162-P1-Z only).
- Connector with cable (Order Separately) is available. EE-5002 1M (Refer to page 5.)



 Be sure to read *Safety Precautions* on page 3.

Features

Models with Connectors Eliminate the Need for a Separate PCB
All-in-One Structure Facilitates Downsizing



Models Available for Mounting on X, Y, and Z Axes

Models with connectors are available with different mounting directions.



Application



Office Automation Equipment
(Copier, Printer)



Amusement Equipment



Home Appliances (Air Cleaner)



Vending Machine, ATM

Ordering Information

Photomicrosensor

| Appearance | Sensing method | Connecting method | Sensing distance | Aperture size (H x W) (mm) | Output type | Power supply voltage | Output configuration | Model |
|-------------------------|--------------------------|-------------------|-------------------|---|-------------|----------------------|----------------------|--------------------------------|
| Side mounting | Transmissive (slot type) | Connector | 5 mm (Slot width) | Emitter 1.4 x 1.4 Detector 1.4 x 0.5 | Photo IC | 12 VDC | Dark-ON | EE-SX3162-P1 EE-SX3162-P1-Z |
| L-shaped mounting | | | | | | | Light-ON | EE-SX4162-P1 EE-SX4162-P1-Z |
| | | | | | | | 5 VDC | Dark-ON |
| Light-ON | | | | | | | | EE-SX4162-P2 |
| Horizontal mounting | | | | | | 12 VDC | Dark-ON | EE-SX3163-P1 EE-SX4163-P1 |
| | | | | | | | Light-ON | EE-SX4163-P2 |
| | | | | | | 5 VDC | Dark-ON | EE-SX3163-P2 |
| | | | | | | | Light-ON | EE-SX4163-P2 |
| | | | | | | 12 VDC | Dark-ON | EE-SX3164-P1 EE-SX4164-P1 |
| | | | | | | | Light-ON | EE-SX4164-P2 |
| | | | | | | 5 VDC | Dark-ON | EE-SX3164-P2 |
| | | | | | | | Light-ON | EE-SX4164-P2 |

Ratings, Characteristics and Exterior Specifications

Absolute Maximum Ratings (Ta = 25°C)

| Item | Symbol | Rated value | | Unit | Remarks |
|--------------------------------|------------------|--|--|------|---------|
| | | EE-SX3162-P1 EE-SX3162-P1-Z EE-SX3163-P1 EE-SX3164-P1 EE-SX4162-P1 EE-SX4162-P1-Z EE-SX4163-P1 EE-SX4164-P1 | EE-SX3162-P2 EE-SX3163-P2 EE-SX3164-P2 EE-SX4162-P2 EE-SX4163-P2 EE-SX4164-P2 | | |
| Power supply voltage | V _{CC} | 13.2 DC | 5.5 DC | V | — |
| Output voltage | V _{OUT} | 13.2 | | V | — |
| Output current | I _{OUT} | 16 | | mA | — |
| Permissible output dissipation | P _{OUT} | 80 | | mW | —* |
| Operating temperature | T _{opr} | -20 to +85 | | °C | —* |
| Storage temperature | T _{stg} | -30 to +85 | | °C | —* |

* Even if the specified conditions are met, perform derating of the voltage and current as required by the temperature rating diagram. Also, do not expose the product to freezing or condensation.

Exterior Specifications

| Appearance | Side mounting | L-shaped mounting | Horizontal mounting |
|-------------------|--|--|--|
| Item | EE-SX3162-P1 EE-SX3162-P1-Z EE-SX4162-P1 EE-SX4162-P1-Z EE-SX3162-P2 EE-SX4162-P2 | EE-SX3163-P1 EE-SX4163-P1 EE-SX3163-P2 EE-SX4163-P2 | EE-SX3164-P1 EE-SX4164-P1 EE-SX3164-P2 EE-SX4164-P2 |
| Connecting method | Connector | | |
| Weight | Approx. 1.2 g | Approx. 1.4 g | Approx. 1.1 g |
| Material | Case | Polybutylene terephthalate (PBT) | |
| | Emitter and receiver sections | Polyphenylene sulfide (PPS) | |

Electrical and Optical Characteristics (Ta = 25°C)

| Item | Symbol | Rated value | |
|---------------------------|-----------------|---|--|
| | | 12 VDC model | 5 VDC model |
| Dark-ON | Dark-ON | EE-SX3162-P1 EE-SX3162-P1-Z EE-SX3163-P1 EE-SX3164-P1 | EE-SX3162-P2 EE-SX3163-P2 EE-SX3164-P2 |
| | | EE-SX4162-P1 EE-SX4162-P1-Z EE-SX4163-P1 EE-SX4164-P1 | EE-SX4162-P2 EE-SX4163-P2 EE-SX4164-P2 |
| Power supply voltage | V _{CC} | 10.8 to 13.2VDC | 4.5 to 5.5 VDC |
| Current consumption | I _{CC} | 25 mA max. (With and without incident) | |
| Low-level output voltage | V _{OL} | 0.3 V max. (I _{OUT} =16 mA) (Dark-ON: without incident, Light-ON: with incident) | |
| High-level output voltage | V _{OH} | (V _{CC} ×0.9 V max. (V _{OUT} =V _{CC} , R _L =47 kΩ)) (Dark-ON: with incident, Light-ON: without incident) | |
| Response frequency | f | 3 kHz min. (V _{OUT} =V _{CC} , I _{OUT} =16 mA *1) | |
| | | 1 kHz min. (V _{OUT} =V _{CC} , I _{OUT} =16 mA *1, *2) | |

*1. The value of the response frequency is measured by rotating the disk as shown below.



*2. Only with models ending in -Z.

Engineering Data (Reference value)

Fig 1. Output Allowable Dissipation vs. Ambient Temperature Characteristics



Fig 2. Sensing Position Characteristics (Typical)



Fig 3. Sensing Position Characteristics (Typical)

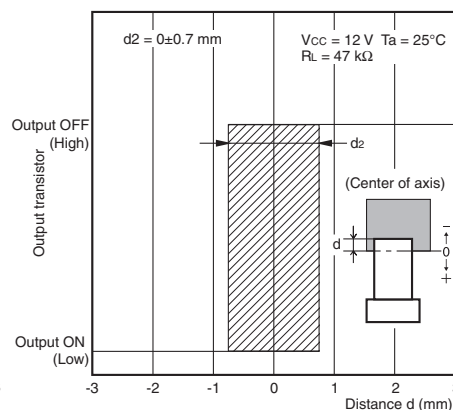

Safety Precautions

To ensure safe operation, be sure to read and follow the Instruction Manual provided with the Sensor.

CAUTION

This product is not designed or rated for ensuring safety of persons either directly or indirectly. Do not use it for such purposes.



Precautions for Correct Use

Do not use the product in atmospheres or environments that exceed product ratings. Dispose of this product as industrial waste.

Precautions for Safe Use

Do not use the product with a voltage or current that exceeds the rated range.

Applying a voltage or current that is higher than the rated range may result in explosion or fire.

Do not miswire such as the polarity of the power supply voltage.

Otherwise the product may be damaged or it may burn.

Do not short-circuit the load.

Otherwise explosion or burning may occur.

This product does not resist water. Do not use the product in places where water or oil may be sprayed onto the product.

Dimensions and Internal Circuit

(Unit: mm)

Photomicrosensor

- EE-SX3162-P1
- EE-SX3162-P1-Z
- EE-SX4162-P1
- EE-SX4162-P1-Z
- EE-SX3162-P2
- EE-SX4162-P2



Aperture size (H x W)

| Emitter | Detector |
|-----------|-----------|
| 1.4 x 1.4 | 1.4 x 0.5 |



Recommended Mating Connectors:
JST (Japan Solderless Terminal) GHR-03

Unless otherwise specified, the tolerances are as shown below.

| Dimensions | Tolerance |
|--------------|-----------|
| 3 mm max. | ±0.2 |
| 3 < mm ≤ 6 | ±0.24 |
| 6 < mm ≤ 10 | ±0.29 |
| 10 < mm ≤ 18 | ±0.35 |
| 18 < mm ≤ 30 | ±0.42 |

Note: Dimensions in parentheses are for reference only.

Internal Circuit



| Terminal No. | Name |
|--------------|--------------------|
| (1) | Ground (GND) |
| (2) | Output (OUT) |
| (3) | Power supply (Vcc) |

Note: Only with models ending in -Z.

- EE-SX3163-P1
- EE-SX4163-P1
- EE-SX3163-P2
- EE-SX4163-P2



Aperture size (H x W)

| Emitter | Detector |
|-----------|-----------|
| 1.4 x 1.4 | 1.4 x 0.5 |



Recommended Mating Connectors:
JST (Japan Solderless Terminal) GHR-03

Unless otherwise specified, the tolerances are as shown below.

| Dimensions | Tolerance |
|--------------|-----------|
| 3 mm max. | ±0.2 |
| 3 < mm ≤ 6 | ±0.24 |
| 6 < mm ≤ 10 | ±0.29 |
| 10 < mm ≤ 18 | ±0.35 |
| 18 < mm ≤ 30 | ±0.42 |

Note: Dimensions in parentheses are for reference only.

Internal Circuit



| Terminal No. | Name |
|--------------|--------------------|
| (1) | Ground (GND) |
| (2) | Output (OUT) |
| (3) | Power supply (Vcc) |

EE-SX3162/3163/3164-P Series EE-SX4162/4163/4164-P Series EE-5002 1M

EE-SX3164-P1
 EE-SX4164-P1
 EE-SX3164-P2
 EE-SX4164-P2



Aperture size (H x W)

| Emitter | Detector |
|-----------|-----------|
| 1.4 x 1.4 | 1.4 x 0.5 |

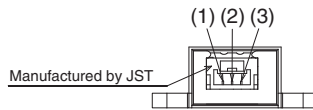

Recommended Mating Connectors:
 JST (Japan Solderless Terminal) GHR-03

Internal Circuit



| Terminal No. | Name |
|--------------|--------------------|
| (1) | Ground (GND) |
| (2) | Output (OUT) |
| (3) | Power supply (Vcc) |

Unless otherwise specified, the tolerances are as shown below.

| Dimensions | Tolerance |
|--------------|-----------|
| 3 mm max. | ±0.2 |
| 3 < mm ≤ 6 | ±0.24 |
| 6 < mm ≤ 10 | ±0.29 |
| 10 < mm ≤ 18 | ±0.35 |
| 18 < mm ≤ 30 | ±0.42 |

Note: Dimensions in parentheses are for reference only.

Connector with cable (Order Separately)

EE-5002 1M



| No. | Name | Model/ Specifications | Quantity | Manufacturer |
|-----|-----------------------------------|-----------------------|----------|--------------|
| (1) | Connector, HS for 101-150 harness | GHR-03V-S | 1 | JST |
| (2) | Connector, CT for 101-150 harness | SSHL-002TP0.2 | 3 | JST |
| (3) | Lead wires | UL1061 AWG26 | 3 | — |

Wiring

| Connector circuit number | Lead-wire color |
|--------------------------|-----------------|
| 1 | Blue |
| 2 | Black |
| 3 | Brown |

- Application examples provided in this document are for reference only. In actual applications, confirm equipment functions and safety before using the product.
- Consult your OMRON representative before using the product under conditions which are not described in the manual or applying the product to nuclear control systems, railroad systems, aviation systems, vehicles, combustion systems, medical equipment, amusement machines, safety equipment, and other systems or equipment that may have a serious influence on lives and property if used improperly. Make sure that the ratings and performance characteristics of the product provide a margin of safety for the system or equipment, and be sure to provide the system or equipment with double safety mechanisms.

Note: Do not use this document to operate the Unit.

Компания «Life Electronics» занимается поставками электронных компонентов импортного и отечественного производства от производителей и со складов крупных дистрибьюторов Европы, Америки и Азии.

С конца 2013 года компания активно расширяет линейку поставок компонентов по направлению коаксиальный кабель, кварцевые генераторы и конденсаторы (керамические, пленочные, электролитические), за счёт заключения дистрибьюторских договоров

Мы предлагаем:

- Конкурентоспособные цены и скидки постоянным клиентам.
- Специальные условия для постоянных клиентов.
- Подбор аналогов.
- Поставку компонентов в любых объемах, удовлетворяющих вашим потребностям.
- Приемлемые сроки поставки, возможна ускоренная поставка.
- Доставку товара в любую точку России и стран СНГ.
- Комплексную поставку.
- Работу по проектам и поставку образцов.
- Формирование склада под заказчика.
- Сертификаты соответствия на поставляемую продукцию (по желанию клиента).
- Тестирование поставляемой продукции.
- Поставку компонентов, требующих военную и космическую приемку.
- Входной контроль качества.
- Наличие сертификата ISO.

В составе нашей компании организован Конструкторский отдел, призванный помогать разработчикам, и инженерам.

Конструкторский отдел помогает осуществить:

- Регистрацию проекта у производителя компонентов.
- Техническую поддержку проекта.
- Защиту от снятия компонента с производства.
- Оценку стоимости проекта по компонентам.
- Изготовление тестовой платы монтаж и пусконаладочные работы.



Тел: +7 (812) 336 43 04 (многоканальный)
Email: org@lifeelectronics.ru