

**SIDACtor® Primary Protection Balanced Series - Modified TO-220**

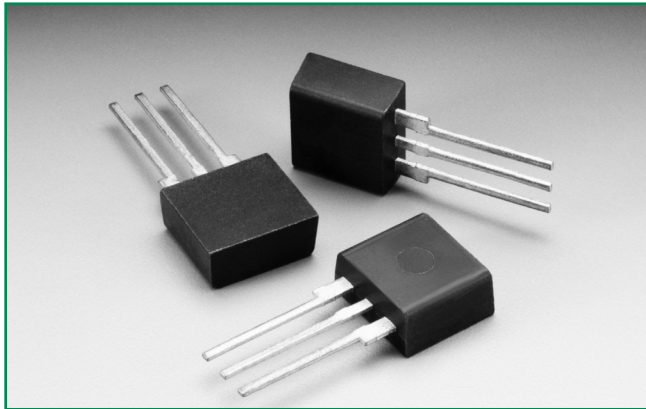

**Agency Approvals**

Agency	Agency File Number
	E133083

**Pinout Designation**

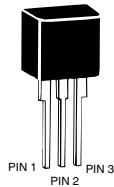

**Schematic Symbol**



**Description**

The SIDACtor® Primary Protection Balanced Series Modified TO-220 thyristors are components designed for use in primary protection applications.

The series provides a single port overvoltage solution that enables applications to comply with the balance requirements of GR-974 and GTS-8700. Please contact Littelfuse to discuss your particular application and regulatory requirements.

**Features and Benefits**

- High holding current options available
- Balanced overvoltage protection
- Failsafe option available
- Low voltage overshoot
- Low on-state voltage
- Does not degrade surge capability after multiple surge events within limit.
- Fails short circuit when surged in excess of ratings
- Single-port protection
- Modified TO-220 Package
- Lead forms available
- RoHS Compliant
- Pb-free E3 means 2nd level interconnect is Pb-free and the terminal finish material is tin(Sn) IPC/JEDEC J-STD-609A.01

**Applicable Global Standards**

- GR-974
- GTS-8700
- UL 497
- ITU K.28

**Electrical Characteristics**

Part Number	Marking	$V_{DRM}$ @ $I_{DRM}=5\mu A$		$V_s$ @ 100V/ $\mu s$	$I_H^*$	$I_s$	$I_T$	$V_T @ I_T=2.2$ Amps	Capacitance			
		V min	V max	mA min	mA max	A max	V max	Pin 1-2 / 3-2 Tip-Ground, Ring-Ground		Pin 1-3 Tip-Ring		
		Pins 1-2, 3-2, 1-3						pF min	pF max	pF min	pF max	
P1553ACLxx	P1553AC	130	180	150	800	2.2	8	65	95	40	60	
P1803ACLxx	P1803AC	150	210	150	800	2.2	8	55	85	35	55	
P2103ACLxx	P2103AC	170	250	150	800	2.2	8	55	85	30	55	
P2353ACLxx	P2353AC	200	270	150	800	2.2	8	50	75	30	50	
P2703ACLxx	P2703AC	230	300	150	800	2.2	8	50	75	30	50	
P3203ACLxx	P3203AC	270	350	150	800	2.2	8	45	70	25	45	
P3403ACLxx	P3403AC	300	400	150	800	2.2	8	45	65	25	45	
P5103ACLxx	P5103AC	420	600	150	800	2.2	8	40	60	20	40	

Notes:  
\* Higher holding current available by special order. Contact Littelfuse for additional information.  
- Absolute maximum ratings measured at  $T_A = 25^\circ C$  (unless otherwise noted).  
- Components are bi-directional.

- Off-state capacitance ( $C_o$ ) is measured at 1 MHz with a 2 V bias.  
- xx Part Number Suffix: **RP** (Reel pack), **Blank** (Bulk pack), **60** (Type 60 lead form bulk pack), **FS1** (Failsafe option bulk pack). Refer to Part Numbering section for additional details.

### Surge Ratings

Series	$I_{PP}$									$I_{TSM}$ 50/60 Hz	di/dt
	0.2/310 <sup>1</sup>	2/10 <sup>1</sup>	8/20 <sup>1</sup>	10/160 <sup>1</sup>	10/560 <sup>1</sup>	5/320 <sup>1</sup>	10/360 <sup>1</sup>	10/1000 <sup>1</sup>	5/310 <sup>1</sup>		
	0.5/700 <sup>2</sup>	2/10 <sup>2</sup>	1.2/50 <sup>2</sup>	10/160 <sup>2</sup>	10/560 <sup>2</sup>	9/720 <sup>2</sup>	10/360 <sup>2</sup>	10/1000 <sup>2</sup>	10/700 <sup>2</sup>		
	A min	A min	A min	A min	A min	A min	A min	A min	A min	A min	A/μs max
C	50	500	400	200	150	200	175	100	200	50	500

Notes:

- 1 Current waveform in μs
- 2 Voltage waveform in μs

- Peak pulse current rating ( $I_{pp}$ ) is repetitive and guaranteed for the life of the product in thermal equilibrium.
- $I_{pp}$  ratings applicable over temperature range of -40°C to +85°C
- The component must initially be in thermal equilibrium with -40°C ≤  $T_J$  ≤ +150°C

### Thermal Considerations

Package	Symbol	Parameter	Value	Unit
Modified TO-220 	$T_J$	Operating Junction Temperature Range	-40 to +150	°C
	$T_S$	Storage Temperature Range	-65 to +150	°C
	$R_{θJA}$	Thermal Resistance: Junction to Ambient	50	°C/W

### V-I Characteristics



### $t_r \times t_d$ Pulse Waveform



### Normalized $V_S$ Change vs. Junction Temperature



### Normalized DC Holding Current vs. Case Temperature



**Soldering Parameters**

Reflow Condition		Pb-Free assembly (see Fig. 1)
Pre Heat	-Temperature Min ( $T_{s(min)}$ )	+150°C
	-Temperature Max ( $T_{s(max)}$ )	+200°C
	-Time (Min to Max) ( $t_s$ )	60-180 secs.
Average ramp up rate (Liquidus Temp ( $T_L$ ) to peak)		3°C/sec. Max.
$T_{s(max)}$ to $T_L$ - Ramp-up Rate		3°C/sec. Max.
Reflow	-Temperature ( $T_L$ ) (Liquidus)	+217°C
	-Temperature ( $t_L$ )	60-150 secs.
Peak Temp ( $T_p$ )		+260(+0/-5)°C
Time within 5°C of actual Peak Temp ( $t_p$ )		30 secs. Max.
Ramp-down Rate		6°C/sec. Max.
Time 25°C to Peak Temp ( $T_p$ )		8 min. Max.
Do not exceed		+260°C



**Physical Specifications**

<b>Lead Material</b>	Copper Alloy
<b>Terminal Finish</b>	100% Matte-Tin Plated
<b>Body Material</b>	UL Recognized epoxy meeting flammability classification V-0

**Environmental Specifications**

<b>High Temp Voltage Blocking</b>	80% Rated $V_{DRM}$ ( $V_{AC Peak}$ ) +125°C or +150°C, 504 or 1008 hrs. MIL-STD-750 (Method 1040) JEDEC, JESD22-A-101
<b>Temp Cycling</b>	-65°C to +150°C, 15 min. dwell, 10 up to 100 cycles. MIL-STD-750 (Method 1051) EIA/JEDEC, JESD22-A-104
<b>Biased Temp &amp; Humidity</b>	52 $V_{DC}$ (+85°C) 85%RH, 504 up to 1008 hrs. EIA/JEDEC, JESD22-A-101
<b>High Temp Storage</b>	+150°C 1008 hrs. MIL-STD-750 (Method 1031) JEDEC, JESD22-A-101
<b>Low Temp Storage</b>	-65°C, 1008 hrs.
<b>Thermal Shock</b>	0°C to +100°C, 5 min. dwell, 10 sec. transfer, 10 cycles. MIL-STD-750 (Method 1056) JEDEC, JESD22-A-106
<b>Autoclave (Pressure Cooker Test)</b>	+121°C, 100%RH, 2atm, 24 up to 168 hrs. EIA/JEDEC, JESD22-A-102
<b>Resistance to Solder Heat</b>	+260°C, 30 secs. MIL-STD-750 (Method 2031)
<b>Moisture Sensitivity Level</b>	85%RH, +85°C, 168 hrs., 3 reflow cycles (+260°C Peak). JEDEC-J-STD-020, Level 1

**Part Numbering**



**Part Marking**



### Dimensions - Modified TO-220



The modified TO-220 package is designed to meet mechanical standards as set forth in JEDEC publication number 95.

	Inches		Millimeters	
	Min	Max	Min	Max
<b>A</b>	0.400	0.410	10.16	10.42
<b>D</b>	0.360	0.375	9.14	9.53
<b>F</b>	0.110	0.130	2.80	3.30
<b>G</b>	0.540	0.575	13.71	14.61
<b>H</b>	0.025	0.035	0.63	0.89
<b>J</b>	0.195	0.205	4.95	5.21
<b>K</b>	0.095	0.105	2.41	2.67
<b>L</b>	0.060	0.075	1.52	1.90
<b>M</b>	0.070	0.085	1.78	2.16
<b>N</b>	0.018	0.024	0.46	0.61
<b>O</b>	0.178	0.188	4.52	4.78
<b>P</b>	0.290	0.310	7.37	7.87

### Dimensions - Modified TO-220 with Failsafe



### Tape and Reel Specification - Modified TO-220



### Dimensions - Modified TO-220 Type 60 with Failsafe



### Packing Options

Package Type	Description	Quantity	Added Suffix	Industry Standard
A	Modified TO-220 Tape and Reel Pack	700	RP	EIA-468-B
	Modified TO-220 Bulk Pack	500	(no added suffix)	N/A
	Modified TO-220 Type 60 Lead Form Bulk Pack	500	60 (special order item, contact factory for details)	N/A

**Disclaimer Notice - Information furnished is believed to be accurate and reliable. However, users should independently evaluate the suitability of and test each product selected for their own applications. Littelfuse products are not designed for, and may not be used in, all applications. Read complete Disclaimer Notice at [www.littelfuse.com/disclaimer-electronics](http://www.littelfuse.com/disclaimer-electronics).**

Компания «Life Electronics» занимается поставками электронных компонентов импортного и отечественного производства от производителей и со складов крупных дистрибьюторов Европы, Америки и Азии.

С конца 2013 года компания активно расширяет линейку поставок компонентов по направлению коаксиальный кабель, кварцевые генераторы и конденсаторы (керамические, пленочные, электролитические), за счёт заключения дистрибьюторских договоров

Мы предлагаем:

- Конкурентоспособные цены и скидки постоянным клиентам.
- Специальные условия для постоянных клиентов.
- Подбор аналогов.
- Поставку компонентов в любых объемах, удовлетворяющих вашим потребностям.
- Приемлемые сроки поставки, возможна ускоренная поставка.
- Доставку товара в любую точку России и стран СНГ.
- Комплексную поставку.
- Работу по проектам и поставку образцов.
- Формирование склада под заказчика.
- Сертификаты соответствия на поставляемую продукцию (по желанию клиента).
- Тестирование поставляемой продукции.
- Поставку компонентов, требующих военную и космическую приемку.
- Входной контроль качества.
- Наличие сертификата ISO.

В составе нашей компании организован Конструкторский отдел, призванный помогать разработчикам, и инженерам.

Конструкторский отдел помогает осуществить:

- Регистрацию проекта у производителя компонентов.
- Техническую поддержку проекта.
- Защиту от снятия компонента с производства.
- Оценку стоимости проекта по компонентам.
- Изготовление тестовой платы монтаж и пусконаладочные работы.



Тел: +7 (812) 336 43 04 (многоканальный)

Email: [org@lifeelectronics.ru](mailto:org@lifeelectronics.ru)