

Variable Transformers
Series 5000 • 28.0 to 252.0 Amperes

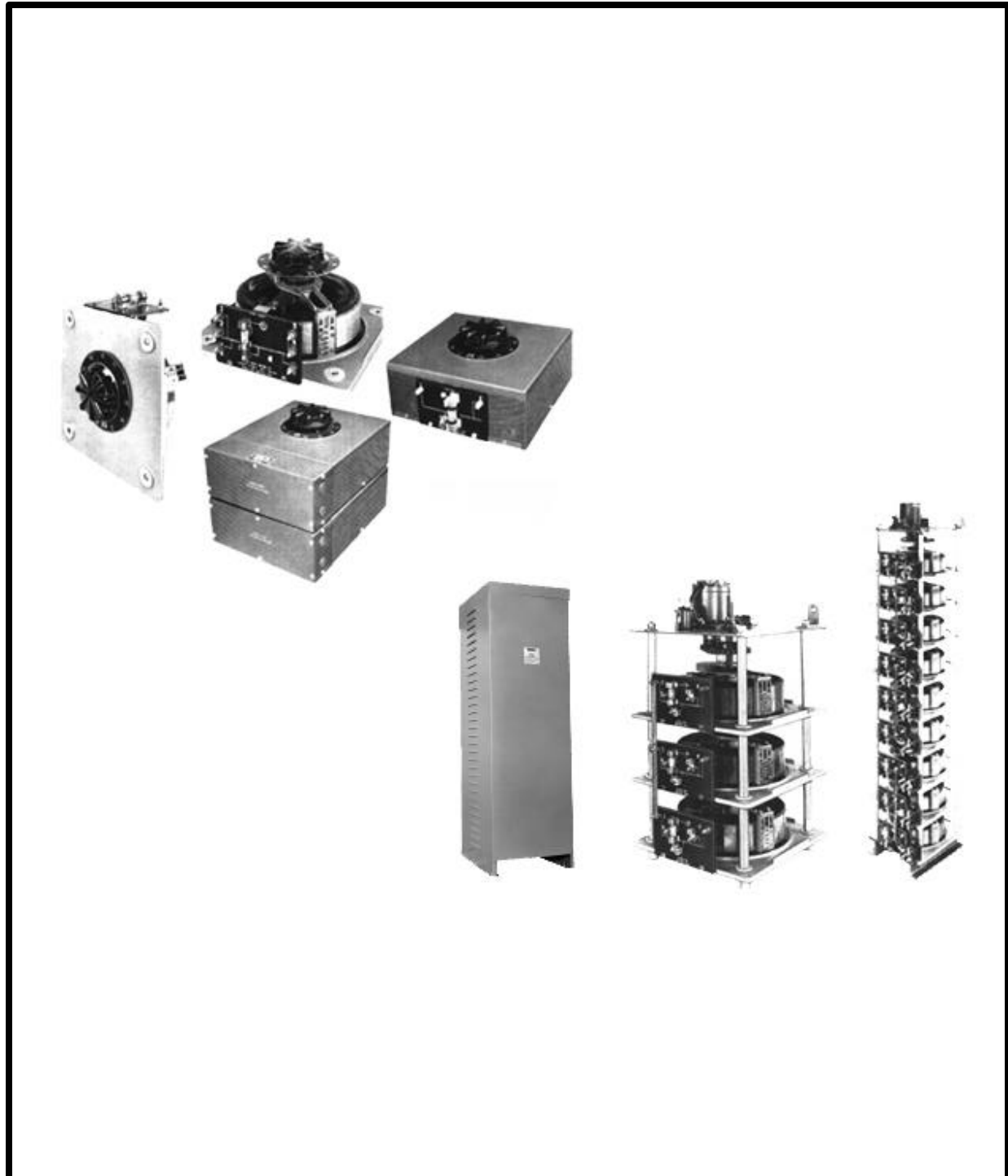

5000 Series

The 5011/5021 Series Variable transformers are designed to control large KVA requirements. The 5011 operates on 120 volts and is rated for constant current of 50 amperes. The 5021 operates on 240 volts and constant current of 28 amperes. The 5011 Series units have coil tapping arrangements allowing output voltage from 0-117% of line voltage, while the 5021 Series allows output voltage from 0 to line voltage or 17% above line voltage. They can be operated at frequencies between 50 and 400 Hertz with a rating at higher than rated frequency.

Adjustable shaft design on manually operated models permits back-of-panel or bench mounting. Terminals are 1/4" screw type. For single and two ganged units, case styles are available in either "C" style, which encloses only the coil, or the "CT" style,

which provides protective housing for both the coil and terminal board. Knockouts are provided in the terminal board housing to accommodate conduit or cable connections. For three ganged and above, we offer our Nema 1, dripproof, fully front accessible "E" enclosure.

Motor-driven models are available from single thru 27 ganged assemblies; cased or uncased (identified with the prefix "M" in the part number). The synchronous motor is designed for operation on 120 volt, 50/60 Hertz, single phase lines and draws approximately 0.3 amperes. To meet a wide range of application requirements, standard motor speeds of 5, 15, 30 and 60 seconds are available depending upon the size of the variable transformer.

PART NUMBER		WIRING	INPUT		OUTPUT			SHAFT ROTATION FOR VOLTAGE INCREASE	TERMINAL CONNECTIONS For Increasing Voltage As Viewed from Rotor End		SCHE-MATIC (Pg 8 & 9)	NET WEIGHT IN LBS. (MAX)	
MANUALLY OPERATED	MOTOR DRIVEN		VOLTS	HERTZ	VOLTS	MAX AMPS	MAX KVA		INPUT	OUTPUT		MAN-UAL	MOTOR DRIVEN
5011 5011C 5011CT	M5011 M5011C M5011CT	Single Phase	120	50/60	0-140	50	7.0	CW	1-2	1-3	18	57	78
5021 5021C 5021CT	M5021 M5021C M5021CT	Single Phase	240	50/60	0-240	28	6.7	CW	2-4	2-3	19	57	78
					0-280	28	7.8	CCW	4-2	4-3			
			120	50/60	0-280	28*-12 VD	3.4‡	CW	2-5	2-3			
5011-2D 5011C-2D 5011CT-2D	M5011-2D M5011C-2D M5011CT-2D	Three Phase Open Delta	120	50/60	0-140	50	12.1	CW	2-1-2	3-1-3	20 & 5	134	155
5011-2P 5011C-2P 5011CT-2P	M5011-2P M5011C-2P M5011CT-2P	Single Phase Parallel	120	50/60	0-140	100	14.0	CW	1-2	1-B	21	136	157
5011-2S 5011C-2S 5011CT-2S	M5011-2S M5011C-2S M5011CT-2S	Single Phase Series	240	50/60	0-280	50	14.0	CW	2-2	3-3	20 & 4	134	155
5021-2D 5021C-2D 5021CT-2D	M5021-2D M5021C-2D M5021CT-2D	Three Phase Open Delta	240	50/60	0-240	28	11.6	CW	4-1-4	3-1-3	20 & 5	134	155
					0-280	28	13.6	CW	2-1-2	3-1-3			
5021-2P 5021C-2P 5021CT-2P	M5021-2P M5021C-2P M5021CT-2P	Single Phase Parallel	240	50/60	0-240	56	13.4	CW	1-4	1-B	21	136	157
					0-280	56	15.7	CW	1-2	1-B			
5021-2S 5021C-2S 5021CT-2S	M5021-2S M5021C-2S M5021CT-2S	Single Phase Series	480	50/60	0-480	28	13.5	CW	4-4	3-3	20 & 4	134	155
					0-560	28	15.7	CW	2-2	3-3			
5011-3P 5011E-3P	M5011-3P M5011E-3P	Single Phase Parallel	120	50/60	0-140	150	21.0	CW	1-2	1-D	22	216	237
5011-3Y 5011E-3Y	M5011-3Y M5011E-3Y	Three Phase Wye	240	60	0-280	50	24.2	CW	2-2-2	3-3-3	20 & 6	212	233

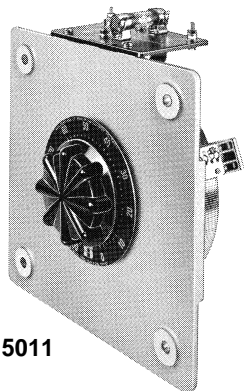

5011



5021

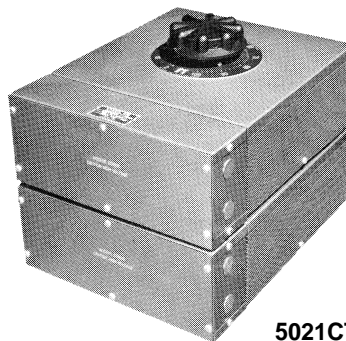

5021CT-2

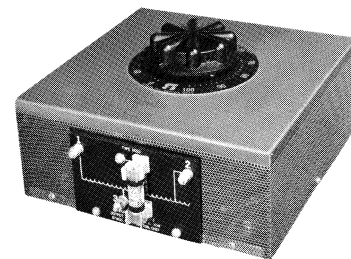

5011C

5000 Series

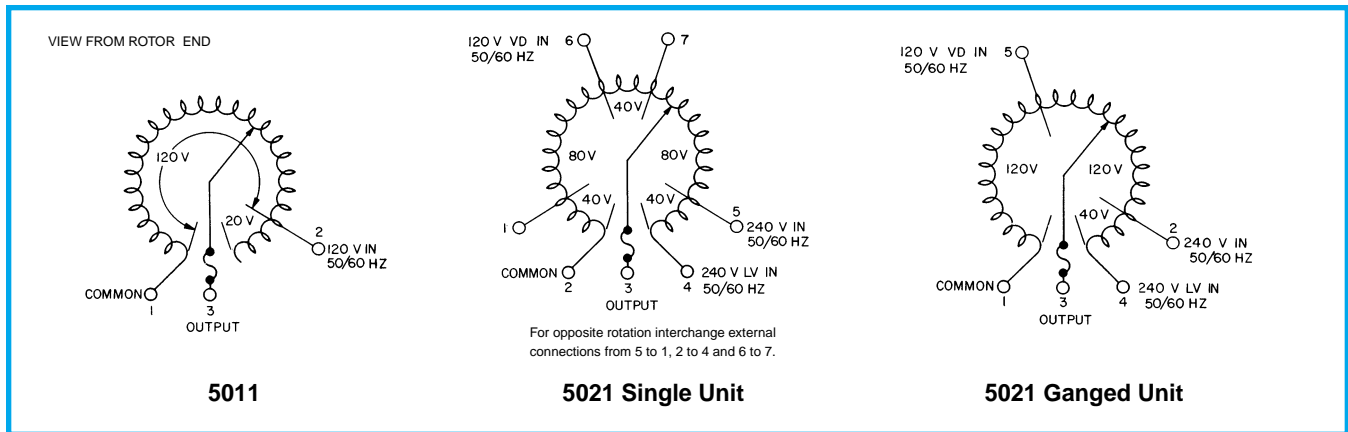

PART NUMBER		WIRING	INPUT		OUTPUT			SHAFT ROTATION FOR VOLTAGE INCREASE	TERMINAL CONNECTIONS For Increasing Voltage As Viewed from Rotor End		SCHEMATIC (Pg 8 & 9)	NET WEIGHT IN LBS. (MAX)	
MANUALLY OPERATED	MOTOR DRIVEN		VOLTS	HERTZ	VOLTS	MAX AMPS	MAX KVA		INPUT	OUTPUT		MANUAL	MOTOR DRIVEN
5021-3P 5021E-3P	M5021-3P M5021E-3P	Single Phase Parallel	240	50/60	0-240	84	20.2	CW	1-4	1-D	22	216	237
					0-280	84	23.5	CW	1-2	1-D			
5021-3Y 5021E-3Y	M5021-3Y M5021E-3Y	Three Phase Wye	480	50/60	0-480	28	23.3	CW	4-4-4	3-3-3	20 & 6	212	233
				60	0-560	28	27.2	CW	2-2-2	3-3-3			
			240	60	0-560	28*	12	11.8†	CW	5-5-5			
5011-4D 5011E-4D	M5011-4D M5011E-4D	Three Phase Open Delta	120	50/60	0-140	100	24.2	CW	2-1-2	B-1-B	21 & 5	314	335
5011-4P 5011E-4P	M5011-4P M5011E-4P	Single Phase Parallel	120	50/60	0-140	200	28.0	CW	1-2	1-D	22	316	337
5011-4PS 5011E-4PS	M5011-4PS M5011E-4PS	Single Phase Series Parallel	240	50/60	0-280	100	28.0	CW	2-2	B-B	21 & 4	314	335
5021-4D 5021E-4D	M5021-4D M5021E-4D	Three Phase Open Delta	240	50/60	0-240	56	23.3	CW	4-1-4	B-1-B	21 & 5	314	335
					0-280	56	27.2	CW	2-1-2	B-1-B			
			120	50/60	0-280	56*	24	11.8†	CW	5-1-5	B-1-B		
5021-4P 5021E-4P	M5021-4P M5021E-4P	Single Phase Parallel	240	50/60	0-240	112	26.9	CW	1-4	1-D	22	316	337
					0-280	112	31.4	CW	1-2	1-D			
			120	50/60	0-280	112*	48	13.5†	CW	1-5			
5021-4PS 5021E-4PS	M5021-4PS M5021E-4PS	Single Phase Series	480	50/60	0-480	56	26.9	CW	4-4	B-B	21 & 4	314	335
					0-560	56	31.4	CW	2-2	B-B			
			240	50/60	0-560	56*	24	13.5†	CW	5-5	B-B		
5011-5P 5011E-5P	M5011-5P M5011E-5P	Single Phase Parallel	120	50/60	0-140	250	35.0	CW	1-2	1-D	22	400	420
5011-6D 5011E-6D	M5011-6D M5011E-6D	Three Phase Open Delta	120	50/60	0-140	150	36.4	CW	2-1-2	D-1-D	22 & 5	481	502
5011-6P 5011E-6P	M5011-6P M5011E-6P	Single Phase Parallel	120	50/60	0-140	300	42.0	CW	1-2	1-D	22	483	504
5011-6PS 5011E-6PS	M5011-6PS M5011E-6PS	Single Phase Series Parallel	240	50/60	0-280	150	42.0	CW	2-2	D-D	22 & 4	481	502
5011-6Y 5011E-6Y	M5011-6Y M5011E-6Y	Three Phase Wye	240	60	0-280	100	48.5	CW	2-2-2	B-B-B	21 & 6	479	500

5000 Series

PART NUMBER		WIRING	INPUT		OUTPUT			SHAFT ROTATION FOR VOLTAGE INCREASE	TERMINAL CONNECTIONS For Increasing Voltage As Viewed from Rotor End		SCHEMATIC (Pg 8 & 9)	NET WEIGHT IN LBS. (MAX)	
MANUALLY OPERATED	MOTOR DRIVEN		VOLTS	HERTZ	VOLTS	MAX AMPS	MAX KVA		INPUT	OUTPUT		MANUAL	MOTOR DRIVEN
5021-6D 5021E-6D	M5021-6D M5021E-6D	Three Phase Open Delta	240	50/60	0-240	84	34.9	CW	4-1-4	D-1-D	22 & 5	481	502
					0-280	84	40.7	CW	2-1-2	D-1-D			
5021-6P 5021E-6P	M5021-6P M5021E-6P	Single Phase Parallel	240	50/60	0-240	168	40.3	CW	1-4	1-D	22	483	504
					0-280	168	47.0	CW	1-2	1-D			
5021-6PS 5021E-6PS	M5021-6PS M5021E-6PS	Single Phase Series Parallel	480	50/60	0-480	84	40.3	CW	4-4	D-D	22 & 4	481	502
					0-560	84	47.0	CW	2-2	D-D			
5021-6Y 5021E-6Y	M5021-6Y M5021E-6Y	Three Phase Wye	480	50/60	0-480	56	46.6	CW	4-4-4	B-B-B	21 & 6	479	500
				60	0-560	56	54.3	CW	2-2-2	B-B-B			
5011-7P 5011E-7P	M5011-7P M5011E-7P	Single Phase Parallel	120	50/60	0-140	350	49.0	CW	1-2	1-D	22	563	584
					0-240	196	47.0	CW	1-4	1-D			
5021-7P 5021E-7P	M5021-7P M5021E-7P	Single Phase Parallel	240	50/60	0-240	196	47.0	CW	1-4	1-D	22	563	584
					0-280	196	54.9	CW	1-2	1-D			
5011-8D 5011E-8D	M5011-8D M5011E-8D	Three Phase Open Delta	120	50/60	0-140	200	48.4	CW	2-1-2	D-1-D	22 & 5	640	661
					0-280	196	54.9	CW	1-2	1-D			
5011-8P 5011E-8P	M5011-8P M5011E-8P	Single Phase Parallel	120	50/60	0-140	400	56.0	CW	1-2	1-D	22	642	663
5011-8PS 5011E-8PS	M5011-8PS M5011E-8PS	Single Phase Series Parallel	240	50/60	0-280	200	56.0	CW	2-2	D-D	22 & 4	640	661
5021-8D 5021E-8D	M5021-8D M5021E-8D	Three Phase Open Delta	240	50/60	0-240	112	46.6	CW	4-1-4	D-1-D	22 & 5	640	661
					0-280	112	54.3	CW	2-1-2	D-1-D			
5021-8P 5021E-8P	M5021-8P M5021E-8P	Single Phase Parallel	240	50/60	0-240	224	53.8	CW	1-4	1-D	22	642	663
					0-280	224	62.7	CW	1-2	1-D			
5021-8PS 5021E-8PS	M5021-8PS M5021E-8PS	Single Phase Series Parallel	480	50/60	0-480	112	53.8	CW	4-4	D-D	22 & 4	640	742
					0-560	112	62.7	CW	2-2	D-D			
5011-9P 5011E-9P	M5011-9P M5011E-9P	Single Phase Parallel	120	50/60	0-140	450	63.0	CW	1-2	1-D	22	721	742
					0-280	150	72.5	CW	2-2-2	D-D-D			
5021-9P 5021E-9P	M5021-9P M5021E-9P	Single Phase Parallel	240	50/60	0-240	252	60.5	CW	1-4	1-D	22	721	742
					0-280	252	70.6	CW	1-2	1-D			
5021-9Y 5021E-9Y	M5021-9Y M5021E-9Y	Three Phase Wye	480	50/60	0-480	84	69.8	CW	4-4-4	D-D-D	22 & 6	717	738
				60	0-560	84	81.5	CW	2-2-2	D-D-D			
—	M5011-10D M5011E-10D	Three Phase Open Delta	120	50/60	0-140	250	60.6	CW	2-1-2	D-1-D	22 & 5	812	812
					0-280	250	70.0	CW	2-2	D-D			
—	M5021-10D M5021E-10D	Three Phase Open Delta	240	50/60	0-240	140	58.2	CW	4-1-4	D-1-D	22 & 5	812	812
					0-280	140	67.9	CW	2-1-2	D-1-D			
—	M5011-10PS M5011E-10PS	Single Phase Series Parallel	240	50/60	0-240	140	58.2	CW	4-1-4	D-1-D	22 & 5	812	812
					0-280	140	67.9	CW	2-1-2	D-1-D			

5000 Series

PART NUMBER		WIRING	INPUT		OUTPUT			SHAFT ROTATION FOR VOLTAGE INCREASE	TERMINAL CONNECTIONS For Increasing Voltage As Viewed from Rotor End		SCHEMATIC (Pg 8 & 9)	NET WEIGHT IN LBS. (MAX)	
MANUALLY OPERATED	MOTOR DRIVEN		VOLTS	HERTZ	VOLTS	MAX AMPS	MAX KVA		INPUT	OUTPUT		MANUAL	MOTOR DRIVEN
—	M5021-10PS M5021E-10PS	Single Phase Series Parallel	480	50/60	0-480	140	67.2	CW	4-4	D-D	22 & 4	—	812
					0-560	140	78.4	CW	2-2	D-D			
			240	50/60	0-560	140*60 V. D.	33.6‡	CW	5-5	D-D			
—	M5011-12D M5011E-12D	Three Phase Open Delta	120	50/60	0-140	300	72.7	CW	2-1-2	D-1-D	22 & 5	—	940
—	M5011-12PS M5011E-12PS	Single Phase Series Parallel	240	50/60	0-280	300	84.0	CW	2-2	D-D	22 & 4	—	940
—	M5021-12D M5021E-12D	Three Phase Open Delta	240	50/60	0-240	168	69.8	CW	4-1-4	D-1-D	22 & 5	—	940
					0-280	168	81.5	CW	2-1-2	D-1-D			
			120	50/60	0-280	168*72 V. D.	34.9‡	CW	5-1-5	D-1-D			
—	M5021-12PS M5021E-12PS	Single Phase Series Parallel	480	50/60	0-480	168	80.6	CW	4-4	D-D	22 & 4	—	940
					0-560	168	94.1	CW	2-2	D-D			
			240	50/60	0-560	168*72 V. D.	40.3‡	CW	5-5	D-D			
—	M5011-14D M5011E-14D	Three Phase Open Delta	120	50/60	0-140	350	84.9	CW	2-1-2	D-1-D	22 & 5	—	1097
—	M5011-14PS M5011E-14PS	Single Phase Series Parallel	240	50/60	0-280	350	98.0	CW	2-2	D-D	22 & 4	—	1097
—	M5021-14D M5021E-14D	Three Phase Open Delta	240	50/60	0-240	196	81.5	CW	4-1-4	D-1-D	22 & 5	—	1097
					0-280	196	95.1	CW	2-1-2	D-1-D			
			120	50/60	0-280	196*84 V. D.	40.8‡	CW	5-1-5	D-1-D			
—	M5021-14PS M5021E-14PS	Single Phase Series Parallel	480	50/60	0-480	196	94.1	CW	4-4	D-D	22 & 4	—	1097
					0-560	196	109.8	CW	2-2	D-D			
			240	50/60	0-560	196*84 V. D.	47.1‡	CW	5-5	D-D			
—	M5011-16D M5011E-16D	Three Phase Open Delta	120	50/60	0-140	400	96.7	CW	2-1-2	D-1-D	22 & 5	—	1254
—	M5011-16PS M5011E-16PS	Single Phase Series Parallel	240	50/60	0-280	400	112.0	CW	2-2	D-D	22 & 4	—	1254
—	M5021-16D M5021E-16D	Three Phase Open Delta	240	50/60	0-240	224	93.1	CW	4-1-4	D-1-D	22 & 5	—	1254
					0-280	224	108.6	CW	2-1-2	D-1-D			
			120	50/60	0-280	224*96 V. D.	46.6‡	CW	5-1-5	D-1-D			
—	M5021-16PS M5021E-16PS	Single Phase Series Parallel	480	50/60	0-480	224	107.5	CW	4-4	D-D	22 & 4	—	1254
					0-560	224	125.5	CW	2-2	D-D			
			240	50/60	0-560	224*96 V. D.	53.8‡	CW	5-5	D-D			
—	M5011-18D M5011E-18D	Three Phase Open Delta	120	50/60	0-140	450	109.0	CW	2-1-2	D-1-D	22 & 5	—	1417
—	M5011-18PS M5011E-18PS	Single Phase Series Parallel	240	50/60	0-280	450	126.0	CW	2-2	D-D	22 & 4	—	1417
—	M5021-18D M5021E-18D	Three Phase Open Delta	240	50/60	0-240	252	104.5	CW	4-1-4	D-1-D	22 & 5	—	1417
					0-280	252	122.2	CW	2-1-2	D-1-D			
			120	50/60	0-280	252*108 V. D.	52.5‡	CW	5-1-5	D-1-D			
—	M5021-18PS M5021E-18PS	Single Phase Series Parallel	480	50/60	0-480	252	121.0	CW	4-4	D-D	22 & 4	—	1417
					0-560	252	141.0	CW	2-2	D-D			
			240	50/60	0-560	252*108 V. D.	60.5‡	CW	5-5	D-D			
—	M5011-12Y M5011E-12Y	Three Phase Wye	240	60	0-280	200	96.7	CW	2-2-2	D-D-D	22 & 6	—	942
—	M5021-12Y M5021E-12Y	Three Phase Wye	480	50/60	0-480	112	93.1	CW	4-4-4	D-D-D	22 & 6	—	942
				60	0-560	112	108.6	CW	2-2-2	D-D-D			
			240	60	0-560	112*48 V. D.	46.6‡	CW	5-5-5	D-D-D			

5000 Series

PART NUMBER		WIRING	INPUT		OUTPUT			SHAFT ROTATION FOR VOLTAGE INCREASE	TERMINAL CONNECTIONS For Increasing Voltage As Viewed from Rotor End		SCHEMATIC (Pg 8 & 9)	NET WEIGHT IN LBS. (MAX)	
MANUALLY OPERATED	MOTOR DRIVEN		VOLTS	HERTZ	VOLTS	MAX AMPS	MAX KVA		INPUT	OUTPUT		MANUAL	MOTOR DRIVEN
—	M5011-15Y M5011E-15Y	Three Phase Wye	240	60	0-280	250	121.0	CW	2-2-2	D-D-D	22 & 6	—	1179
—	M5021-15Y M5021E-15Y	Three Phase Wye	480	50/60	0-480	140	116.5	CW	4-4-4	D-D-D	22 & 6	—	1179
				60	0-560	140	136.0	CW	2-2-2	D-D-D			
—	M5011-18Y M5011E-18Y	Three Phase Wye	240	60	0-280	300	145.5	CW	2-2-2	D-D-D	22 & 6	—	1415
—	M5021-18Y M5021E-18Y	Three Phase Wye	480	50/60	0-480	168	139.5	CW	4-4-4	D-D-D	22 & 6	—	1415
				60	0-560	168	163.3	CW	2-2-2	D-D-D			
—	M5011-21Y M5011E-21Y	Three Phase Wye	240	60	0-280	350	169.5	CW	2-2-2	D-D-D	22 & 6	—	1654
—	M5021-21Y M5021E-21Y	Three Phase Wye	480	50/60	0-480	196	163.0	CW	4-4-4	D-D-D	22 & 6	—	1654
				60	0-560	196	189.5	CW	2-2-2	D-D-D			
—	M5011-24Y M5011E-24Y	Three Phase Wye	240	60	0-280	400	193.7	CW	2-2-2	D-D-D	22 & 5	—	1892
—	M5021-24Y M5021E-24Y	Three Phase Wye	480	50/60	0-480	224	186.5	CW	4-4-4	D-D-D	22 & 6	—	1892
				60	0-560	224	217.8	CW	2-2-2	D-D-D			
—	M5011-27Y M5011E-27Y	Three Phase Wye	240	60	0-280	450	218.4	CW	2-2-2	D-D-D	22 & 6	—	2131
—	M5021-27Y M5021E-27Y	Three Phase Wye	480	50/60	0-480	252	209.5	CW	4-4-4	D-D-D	22 & 6	—	2131
				60	0-560	252	244.0	CW	2-2-2	D-D-D			
—	M5011-27Y M5011E-27Y	Three Phase Wye	240	60	0-560	252* 108 V.D.	105.0†	CW	5-5-5	D-D-D	22 & 6	—	2131

* Maximum output current in output voltage range from 0 to 25 percent above line voltage. At higher output voltages, output current must be reduced according to rating curve, Figure B, page 6.

† Maximum KVA at maximum output and corresponding de-rated current. Maximum KVA at lower output voltages may be calculated from derating curve. Figure B, page 6.

V. D. Voltage Doubler



**5000/6000 Series
Enclosed Unit**



30M6020-9Y



30M5011-3Y

5000/6000 Series



Manual Single, Uncased



Manual Single, Cased



Manual Two-Ganged, Cased



	Single Unit	Two Ganged	Three Ganged
A	13.25" [336.6]	19.32" [490.7]	25.38" [644.5]
B	9.75" [247.7]	15.82" [401.8]	21.88" [555.7]
C (5 sec.)	13.53" [343.7]	19.62" [498.5]	25.75" [654.0]
C (15, 30 & 60 sec.)	15.12" [384.2]	21.19" [538.2]	27.25" [692.0]

Motor Driven, Single, Two and Three-Ganged, Uncased



	Two Ganged	Three Ganged
A	17.06" [433.3]	23.12" [587.4]
B	13.56" [344.4]	19.62" [498.3]
C	15.12" [384.2]	21.19" [538.2]

Manual Two and Three-Ganged, Uncased

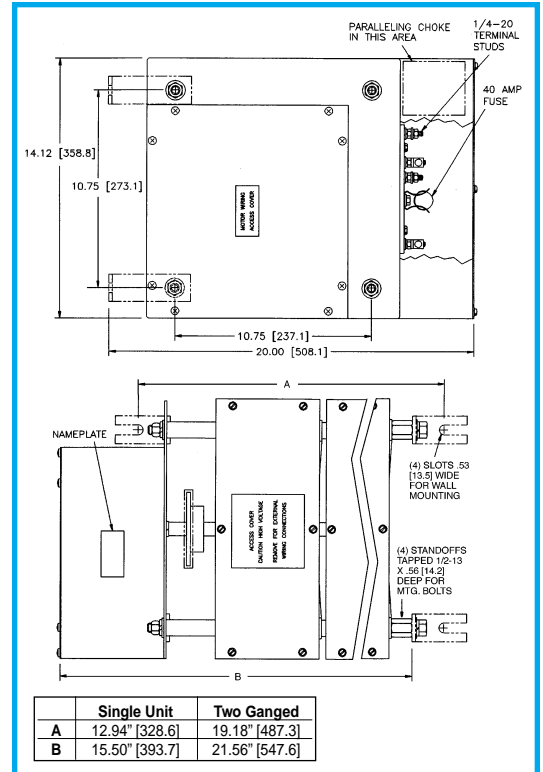

	Single Unit	Two Ganged
A	12.94" [328.6]	19.18" [487.3]
B	15.50" [393.7]	21.56" [547.6]

Motor Driven, Single and Two-Ganged, Cased

5000/6000 Series



Manual Three to Nine-Ganged, Cased



Motor-Driven Three to Nine-Ganged, Cased



Motor-Driven 10, 12, 14, 16 & 18-Ganged Open Delta and Parallel, Cased



Manual Four to Nine-Ganged, Uncased

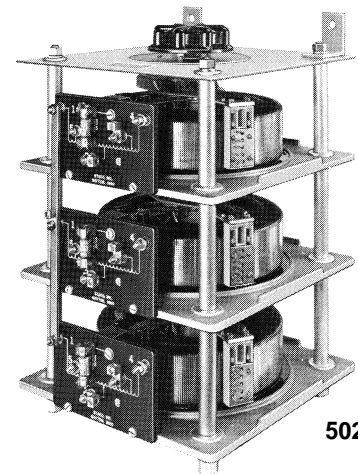

5021-3Y

5000/6000 Series



Motor-Driven 12, 15, 18, 21, 24 & 27-Ganged, Uncased



Motor-Driven 12, 15, 18, 21, 24 & 27-Ganged, Cased



Motor-Driven 10, 12, 14, 16 & 18-Ganged Open Delta & Parallel, Uncased



60M5021-27Y

Компания «Life Electronics» занимается поставками электронных компонентов импортного и отечественного производства от производителей и со складов крупных дистрибьюторов Европы, Америки и Азии.

С конца 2013 года компания активно расширяет линейку поставок компонентов по направлению коаксиальный кабель, кварцевые генераторы и конденсаторы (керамические, пленочные, электролитические), за счёт заключения дистрибьюторских договоров

Мы предлагаем:

- Конкурентоспособные цены и скидки постоянным клиентам.
- Специальные условия для постоянных клиентов.
- Подбор аналогов.
- Поставку компонентов в любых объемах, удовлетворяющих вашим потребностям.
- Приемлемые сроки поставки, возможна ускоренная поставка.
- Доставку товара в любую точку России и стран СНГ.
- Комплексную поставку.
- Работу по проектам и поставку образцов.
- Формирование склада под заказчика.
- Сертификаты соответствия на поставляемую продукцию (по желанию клиента).
- Тестирование поставляемой продукции.
- Поставку компонентов, требующих военную и космическую приемку.
- Входной контроль качества.
- Наличие сертификата ISO.

В составе нашей компании организован Конструкторский отдел, призванный помогать разработчикам, и инженерам.

Конструкторский отдел помогает осуществить:

- Регистрацию проекта у производителя компонентов.
- Техническую поддержку проекта.
- Защиту от снятия компонента с производства.
- Оценку стоимости проекта по компонентам.
- Изготовление тестовой платы монтаж и пусконаладочные работы.



Тел: +7 (812) 336 43 04 (многоканальный)

Email: org@lifeelectronics.ru