

### FEATURES

- 3 dB bandwidth of 5 GHz ( $A_v = 6$  dB)
- Single resistor programmable gain: 0 dB to 18 dB
- Differential or single-ended input to differential output
- Low harmonic distortion (HD2/HD3 @  $A_v = 6$  dB)
  - 88/–69 dBc @ 250 MHz
  - 77/–66 dBc @ 500 MHz
  - 73/–72 dBc @ 1 GHz
- IMD3 @ 1 GHz = –63 dBc
- Slew rate
  - 8700 V/ $\mu$ s ( $A_v = 6$  dB, 2 V step)
  - 6600 V/ $\mu$ s ( $A_v = 18$  dB, 2 V step)
- Fast settling: 1 ns to 1%, 1.4 ns to 0.1%
- Fast overdrive recovery: 6.7 ns to 1%, 9.3 ns to 0.5%
- Single-supply operation: 5 V
- 0.1 dB gain flatness to 300 MHz
- DC level translation
- Available in 16-lead LFCSP

### APPLICATIONS

- Differential ADC drivers for giga-sample ADCs
- GBPS line drivers with pre-emphasis
- High speed data acquisition
- Electronic surveillance countermeasures
- Pulse capture and conditioning
- Oscilloscopes
- Satellite communications
- Single-ended-to-differential converters
- RF/IF gain blocks

### GENERAL DESCRIPTION

The ADA4960-1 is a high performance, differential amplifier optimized for RF and IF applications. It achieves better than 63 dB IMD3 performance for frequencies up to and beyond 1 GHz, making it an ideal driver for 8-bit to 10-bit giga-sample analog-to-digital converters (ADCs).

The buffered inputs of the ADA4960-1 isolate the gain-setting resistor ( $R_G$ ) from the signal inputs, maintaining a constant 10 k $\Omega$  input resistance, easing matching and input drive requirements. The ADA4960-1 has a nominal 150  $\Omega$  differential output impedance.

The ADA4960-1 is optimized for wideband, low distortion performance for frequencies up to and beyond 1 GHz. These attributes, together with its adjustable gain capability, make this device the amplifier of choice for general-purpose IF and broadband applications where low distortion, noise, and power are critical.

#### Rev. 0

Information furnished by Analog Devices is believed to be accurate and reliable. However, no responsibility is assumed by Analog Devices for its use, nor for any infringements of patents or other rights of third parties that may result from its use. Specifications subject to change without notice. No license is granted by implication or otherwise under any patent or patent rights of Analog Devices. Trademarks and registered trademarks are the property of their respective owners.

### FUNCTIONAL BLOCK DIAGRAM

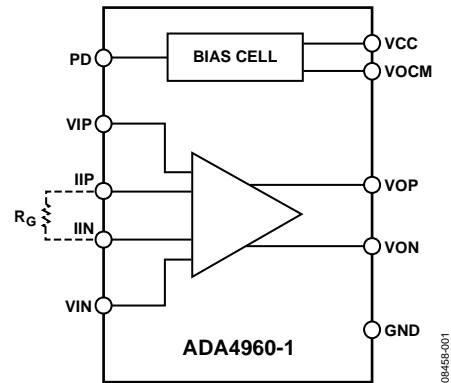

Figure 1.

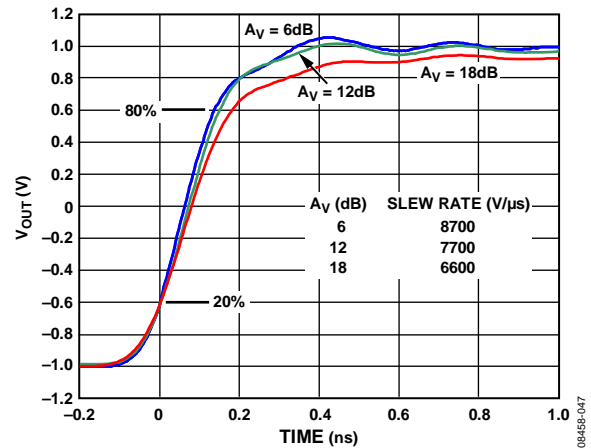

Figure 2. Rise Time,  $V_{OUT} = 2$  V p-p,  $T_A = 25^\circ\text{C}$ ,  
For  $A_v = 6$  dB,  $A_v = 12$  dB, and  $A_v = 18$  dB

The device is optimized for the best combination of slew rate, bandwidth, and broadband distortion. These attributes allow it to drive a wide variety of ADCs. It is ideally suited for driving mixers, pin diode attenuators, SAW filters, and multi-element discrete devices.

The user accessible gain adjust and bandwidth extension features allow configuration of the ADA4960-1 for line driver and channel equalization applications.

The quiescent current of the ADA4960-1 is typically 60 mA. When disabled, it consumes less than 3 mA, offering excellent input-to-output isolation.

Fabricated on an Analog Devices, Inc., high speed SiGe process, the ADA4960-1 is available in a compact 3 mm  $\times$  3 mm, 16-lead LFCSP. It operates over the temperature range of  $-40^\circ\text{C}$  to  $+85^\circ\text{C}$ .

## TABLE OF CONTENTS

Features .....	1	Circuit Description.....	13
Applications.....	1	Basic Structure.....	13
Functional Block Diagram .....	1	Applications Information .....	14
General Description .....	1	Basic Connections.....	14
Revision History .....	2	Input and Output Interfacing .....	14
Specifications.....	3	Gain Adjust .....	15
Absolute Maximum Ratings.....	6	Bandwidth Extension.....	15
Thermal Resistance .....	6	ADC Interfacing.....	16
Maximum Power Dissipation .....	6	Line Driver Applications .....	16
ESD Caution.....	6	Overdrive and Recovery.....	17
Pin Configuration and Function Descriptions.....	7	Layout, Grounding, and Bypassing.....	18
Typical Performance Characteristics .....	8	Outline Dimensions .....	19
Test Circuits.....	12	Ordering Guide .....	19

## REVISION HISTORY

4/10—Revision 0: Initial Version

## SPECIFICATIONS

VCC = 5 V, V<sub>OCM</sub> = 2.5 V, R<sub>L</sub> = 100 Ω differential, A<sub>V</sub> = 6 dB, C<sub>L</sub> = 1 pF differential, f = 140 MHz, T = 25°C. Inputs and outputs are ac-coupled.

Table 1.

Parameter	Conditions	Min	Typ	Max	Unit
<b>DYNAMIC PERFORMANCE</b>					
-3 dB Bandwidth	A <sub>V</sub> = 6 dB, V <sub>OUT</sub> ≤ 1.0 V p-p		5000		MHz
	A <sub>V</sub> = 12 dB, V <sub>OUT</sub> ≤ 1.0 V p-p		2000		MHz
	A <sub>V</sub> = 18 dB, V <sub>OUT</sub> ≤ 1.0 V p-p		1200		MHz
Bandwidth for 0.1 dB Flatness	V <sub>OUT</sub> ≤ 1.0 V p-p		300		MHz
Gain Accuracy	R <sub>G</sub> = 95.3 Ω		0.5		dB
Gain Supply Sensitivity	V <sub>S</sub> ± 5%		0.2		dB/V
Gain Temperature Sensitivity	-40°C to +85°C		2.5		mdB/°C
Slew Rate	A <sub>V</sub> = 6 dB, V <sub>OUT</sub> = 2 V step, 20% to 80%		8700		V/μs
	A <sub>V</sub> = 12 dB, V <sub>OUT</sub> = 2 V step, 20% to 80%		7700		V/μs
	A <sub>V</sub> = 18 dB, V <sub>OUT</sub> = 2 V step, 20% to 80%		6600		V/μs
	A <sub>V</sub> = 6 dB, V <sub>OUT</sub> = 1 V step, 20% to 80%		7200		V/μs
	A <sub>V</sub> = 12 dB, V <sub>OUT</sub> = 1 V step, 20% to 80%		4900		V/μs
	A <sub>V</sub> = 18 dB, V <sub>OUT</sub> = 1 V step, 20% to 80%		3700		V/μs
Settling Time	1 V step to 1%		1		ns
	1 V step to 0.1%		1.4		ns
Overdrive Recovery Time	V <sub>IN</sub> = 1 V to 0 V step, A <sub>V</sub> = 12 dB, V <sub>OUT</sub> ≤ 1%		6.7		ns
	V <sub>IN</sub> = 1 V to 0 V step, A <sub>V</sub> = 12 dB, V <sub>OUT</sub> ≤ 0.5%		9.3		ns
Reverse Isolation (S12)	f = ≤1 GHz		68		dB
<b>INPUT/OUTPUT CHARACTERISTICS</b>					
Output Common Mode			V <sub>S</sub> /2		V
VOCM Adjustment Range		1		2.75	V
Input Common-Mode Range		2.25		2.75	V
Maximum Output Voltage Swing	1 dB compressed		3.5		V p-p
Output Common-Mode Offset	Referenced to VCC/2	-20		+10	mV
Output Common-Mode Drift	-40°C to +85°C		0.05		mV/°C
Output Differential Offset Voltage		-36		+22	mV
Common-Mode Rejection Ratio (CMRR)			60		dB
Output Differential Offset Drift	-40°C to +85°C		0.05		mV/°C
Input Bias Current	-40°C to +85°C		-20		μA
Input Resistance (Differential)	A <sub>V</sub> = all gains		10		kΩ
Input Capacitance (Differential)	A <sub>V</sub> = all gains		0.4		pF
Input Resistance (Single-Ended)	A <sub>V</sub> = all gains		5		kΩ
Input Capacitance (Single-Ended)	A <sub>V</sub> = all gains		0.8		pF
Output Resistance (Differential)			150		Ω
Output Capacitance (Differential)			1.2		pF
<b>POWER INTERFACE</b>					
Supply Voltage		4.75	5.0	5.25	V
ENB Threshold	Low to high	2.2			V
	High to low			1.3	V
ENB Input Bias Current	ENB high		30		μA
	ENBL low		-180		μA
Quiescent Current	ENB high	56	60	64	mA
	ENBL low		2.9		mA

# ADA4960-1

Parameter	Conditions	Min	Typ	Max	Unit
<b>NOISE/HARMONIC PERFORMANCE</b>					
<b>140 MHz</b>					
Second/Third Harmonic Distortion	$A_V = 6 \text{ dB}, V_{OUT} = 0.9 \text{ V p-p}$		-91/-73		dBc
	$A_V = 12 \text{ dB}, V_{OUT} = 0.9 \text{ V p-p}$		-86/-73		dBc
	$A_V = 18 \text{ dB}, V_{OUT} = 0.9 \text{ V p-p}$		-82/-72		dBc
OIP3/IMD3	$A_V = 6 \text{ dB}, V_{OUT} = 0.9 \text{ V p-p composite (2 MHz spacing)}$		+33.2/-79		dBm/dBc
	$A_V = 12 \text{ dB}, V_{OUT} = 0.9 \text{ V p-p composite (2 MHz spacing)}$		+33.4/-78		dBm/dBc
	$A_V = 18 \text{ dB}, V_{OUT} = 0.9 \text{ V p-p composite (2 MHz spacing)}$		+33.3/-78		dBm/dBc
Noise Spectral Density (RTI)	$A_V = 6 \text{ dB}$		5.4		nV/ $\sqrt{\text{Hz}}$
	$A_V = 12 \text{ dB}$		3.2		nV/ $\sqrt{\text{Hz}}$
	$A_V = 18 \text{ dB}$		2.1		nV/ $\sqrt{\text{Hz}}$
1 dB Compression Point (RTO)	$A_V = 6 \text{ dB}$		12.0		dBm
	$A_V = 12 \text{ dB}$		12.0		dBm
	$A_V = 18 \text{ dB}$		11.9		dBm
<b>250 MHz</b>					
Second/Third Harmonic Distortion	$A_V = 6 \text{ dB}, V_{OUT} = 0.9 \text{ V p-p}$		-88/-69		dBc
	$A_V = 12 \text{ dB}, V_{OUT} = 0.9 \text{ V p-p}$		-81/-68		dBc
	$A_V = 18 \text{ dB}, V_{OUT} = 0.9 \text{ V p-p}$		-77/-68		dBc
OIP3/IMD3	$A_V = 6 \text{ dB}, V_{OUT} = 0.9 \text{ V p-p composite (2 MHz spacing)}$		+32.5/-77		dBm/dBc
	$A_V = 12 \text{ dB}, V_{OUT} = 0.9 \text{ V p-p composite (2 MHz spacing)}$		+32.6/-77		dBm/dBc
	$A_V = 18 \text{ dB}, V_{OUT} = 0.9 \text{ V p-p composite (2 MHz spacing)}$		+32.1/-76		dBm/dBc
Noise Spectral Density (RTI)	$A_V = 6 \text{ dB}$		5.4		nV/ $\sqrt{\text{Hz}}$
	$A_V = 12 \text{ dB}$		3.1		nV/ $\sqrt{\text{Hz}}$
	$A_V = 18 \text{ dB}$		2.0		nV/ $\sqrt{\text{Hz}}$
1 dB Compression Point (RTO)	$A_V = 6 \text{ dB}$		12.0		dBm
	$A_V = 12 \text{ dB}$		11.9		dBm
	$A_V = 18 \text{ dB}$		11.7		dBm
<b>500 MHz</b>					
Second/Third Harmonic Distortion	$A_V = 6 \text{ dB}, V_{OUT} = 0.9 \text{ V p-p}$		-77/-66		dBc
	$A_V = 12 \text{ dB}, V_{OUT} = 0.9 \text{ V p-p}$		-71/-66		dBc
	$A_V = 18 \text{ dB}, V_{OUT} = 0.9 \text{ V p-p}$		-68/-65		dBc
OIP3/IMD3	$A_V = 6 \text{ dB}, V_{OUT} = 0.9 \text{ V p-p composite (2 MHz spacing)}$		+30.2/-72		dBm/dBc
	$A_V = 12 \text{ dB}, V_{OUT} = 0.9 \text{ V p-p composite (2 MHz spacing)}$		+29.9/-71		dBm/dBc
	$A_V = 18 \text{ dB}, V_{OUT} = 0.9 \text{ V p-p composite (2 MHz spacing)}$		+29.1/-70		dBm/dBc
Noise Spectral Density (RTI)	$A_V = 6 \text{ dB}$		5.2		nV/ $\sqrt{\text{Hz}}$
	$A_V = 12 \text{ dB}$		3.0		nV/ $\sqrt{\text{Hz}}$
	$A_V = 18 \text{ dB}$		1.9		nV/ $\sqrt{\text{Hz}}$
1 dB Compression Point (RTO)	$A_V = 6 \text{ dB}$		11.6		dBm
	$A_V = 12 \text{ dB}$		11.4		dBm
	$A_V = 18 \text{ dB}$		11.0		dBm
<b>750 MHz</b>					
Second/Third Harmonic Distortion	$A_V = 6 \text{ dB}, V_{OUT} = 0.9 \text{ V p-p}$		-70/-68		dBc
	$A_V = 12 \text{ dB}, V_{OUT} = 0.9 \text{ V p-p}$		-67/-69		dBc
	$A_V = 18 \text{ dB}, V_{OUT} = 0.9 \text{ V p-p}$		-64/-69		dBc
OIP3/IMD3	$A_V = 6 \text{ dB}, V_{OUT} = 0.9 \text{ V p-p composite (2 MHz spacing)}$		+28.3/-67		dBm/dBc
	$A_V = 12 \text{ dB}, V_{OUT} = 0.9 \text{ V p-p composite (2 MHz spacing)}$		+27.7/-67		dBm/dBc
	$A_V = 18 \text{ dB}, V_{OUT} = 0.9 \text{ V p-p composite (2 MHz spacing)}$		+26.9/-65		dBm/dBc
Noise Spectral Density (RTI)	$A_V = 6 \text{ dB}$		5.0		nV/ $\sqrt{\text{Hz}}$
	$A_V = 12 \text{ dB}$		3.0		nV/ $\sqrt{\text{Hz}}$
	$A_V = 18 \text{ dB}$		1.8		nV/ $\sqrt{\text{Hz}}$
1 dB Compression Point (RTO)	$A_V = 6 \text{ dB}$		9.7		dBm
	$A_V = 12 \text{ dB}$		9.5		dBm
	$A_V = 18 \text{ dB}$		9.5		dBm

Parameter	Conditions	Min	Typ	Max	Unit
1000 MHz					
Second/Third Harmonic Distortion	$A_V = 6 \text{ dB}$ , $V_{OUT} = 0.9 \text{ V p-p}$		-73/-72		dBc
	$A_V = 12 \text{ dB}$ , $V_{OUT} = 0.9 \text{ V p-p}$		-69/-78		dBc
	$A_V = 18 \text{ dB}$ , $V_{OUT} = 0.9 \text{ V p-p}$		-67/-85		dBc
OIP3/IMD3	$A_V = 6 \text{ dB}$ , $V_{OUT} = 0.9 \text{ V p-p}$ composite (2 MHz spacing)		+26.2/-63		dBm/dBc
	$A_V = 12 \text{ dB}$ , $V_{OUT} = 0.9 \text{ V p-p}$ composite (2 MHz spacing)		+26.0/-63		dBm/dBc
	$A_V = 18 \text{ dB}$ , $V_{OUT} = 0.9 \text{ V p-p}$ composite (2 MHz spacing)		+25.0/-61		dBm/dBc
Noise Spectral Density (RTI)	$A_V = 6 \text{ dB}$		4.8		nV/ $\sqrt{\text{Hz}}$
	$A_V = 12 \text{ dB}$		2.7		nV/ $\sqrt{\text{Hz}}$
	$A_V = 18 \text{ dB}$		1.6		nV/ $\sqrt{\text{Hz}}$
1 dB Compression Point (RTO)	$A_V = 6 \text{ dB}$		8.0		dBm
	$A_V = 12 \text{ dB}$		7.7		dBm
	$A_V = 18 \text{ dB}$		7.6		dBm

## ABSOLUTE MAXIMUM RATINGS

Table 2.

Parameter	Rating
Supply Voltage, VCC	5.25 V
VIP, VIN	VCC + 0.5 V
Internal Power Dissipation	See Figure 3
Maximum Junction Temperature	150°C
Operating Temperature Range	-40°C to +85°C
Storage Temperature Range	-65°C to +150°C

Stresses above those listed under Absolute Maximum Ratings may cause permanent damage to the device. This is a stress rating only; functional operation of the device at these or any other conditions above those indicated in the operational section of this specification is not implied. Exposure to absolute maximum rating conditions for extended periods may affect device reliability.

### THERMAL RESISTANCE

$\theta_{JA}$  is specified for the device (including the exposed pad) soldered to a high thermal conductivity, 4-layer circuit board, as described in EIA/JESD 51-7.

Table 3. Thermal Resistance

Package Type	$\theta_{JA}$	Unit
16-Lead LFCSP (Exposed Pad)	89.5	°C/W

### MAXIMUM POWER DISSIPATION

The maximum safe power dissipation in the ADA4960-1 package is limited by the associated rise in junction temperature ( $T_J$ ) on the die. At approximately 150°C, which is the glass transition temperature, the plastic changes its properties. Even temporarily exceeding this temperature limit can change the stresses that the package exerts on the die, permanently shifting the parametric performance of the ADA4960-1. Exceeding a junction temperature of 150°C for an extended period can result in changes in the silicon devices, potentially causing failure.

The power dissipated in the package ( $P_D$ ) is the sum of the quiescent power dissipation and the power dissipated in the package due to the load drive. The quiescent power is the voltage between the supply pins ( $V_S$ ) times the quiescent current ( $I_S$ ). The power dissipated due to the load drive depends upon the particular application. The power due to load drive is calculated by multiplying the load current by the associated voltage drop across the device. RMS voltages and currents must be used in these calculations.

Airflow increases heat dissipation, effectively reducing  $\theta_{JA}$ . In addition, more metal directly in contact with the package leads/exposed pad from metal traces, through holes, ground, and power planes reduce  $\theta_{JA}$ .

Figure 3 shows the maximum safe power dissipation of the ADA4960-1 vs. the ambient temperature on a JEDEC standard 4-layer board.

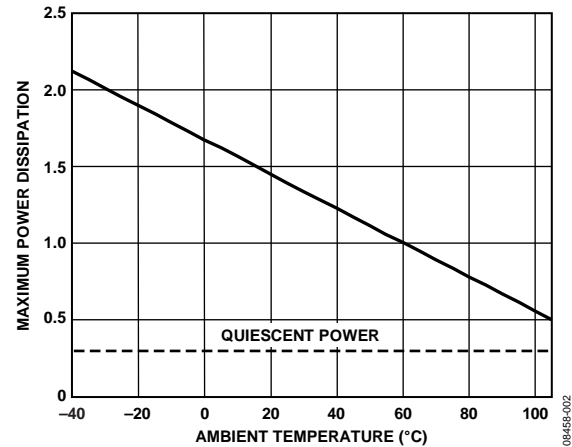

Figure 3. Maximum Power Dissipation vs. Ambient Temperature for 4-Layer Board

### ESD CAUTION



**ESD (electrostatic discharge) sensitive device.** Charged devices and circuit boards can discharge without detection. Although this product features patented or proprietary protection circuitry, damage may occur on devices subjected to high energy ESD. Therefore, proper ESD precautions should be taken to avoid performance degradation or loss of functionality.

## PIN CONFIGURATION AND FUNCTION DESCRIPTIONS

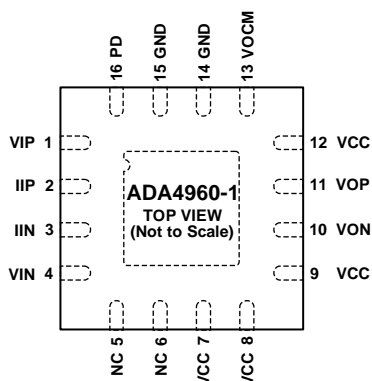

- NOTES
1. NC = NO CONNECT.
  2. EXPOSED PAD MUST BE CONNECTED TO GND.

081458-003

Figure 4. Pin Configuration

Table 4. Pin Function Descriptions

Pin No.	Mnemonic	Description
1	VIP	Balanced Differential Input. This pin is internally biased to $VCC/2$ .
2	IIP	Gain Setting Resistor. Connect $R_G$ between this pin and IIN.
3	IIN	Gain Setting Resistor. Connect $R_G$ between this pin and IIP.
4	VIN	Balanced Differential Input. This pin is internally biased to $VCC/2$ .
5, 6	NC	Leave these pins unconnected.
7, 8, 9, 12	VCC	Positive 5 V Supply Pins.
10	VON	Balanced Differential Output. This pin is biased to the VOCM input voltage.
11	VOP	Balanced Differential Output. This pin is biased to the VOCM input voltage.
13	VOCM	This pin is internally biased at $VCC/2$ . As an input, this pin sets the dc VOP and VON voltages.
14, 15	GND	Ground. Connect this pin to a low impedance ground.
16	PD	This pin grounded disables the part, and at 5 V, this pin turns the part on.
	EPAD	The exposed pad must be connected to GND.

## TYPICAL PERFORMANCE CHARACTERISTICS

VCC = 5 V, VOVM = 2.5 V, RL = 100 Ω differential, AV = 6 dB, CL = 1 pF differential, f = 140 MHz, T = 25°C.

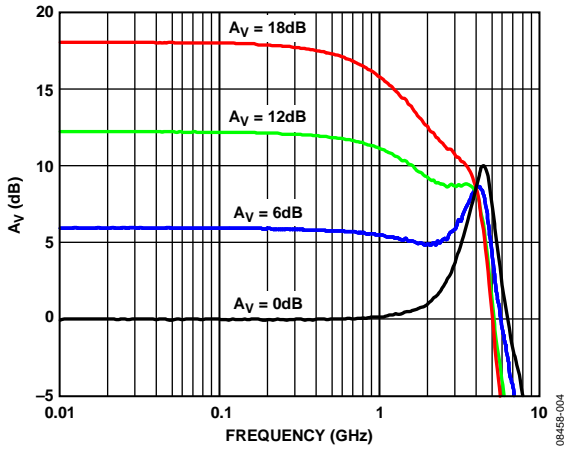

Figure 5. Small Signal Frequency Response, Gain vs. Frequency at AV = 0 dB, AV = 6 dB, AV = 12 dB, and AV = 18 dB

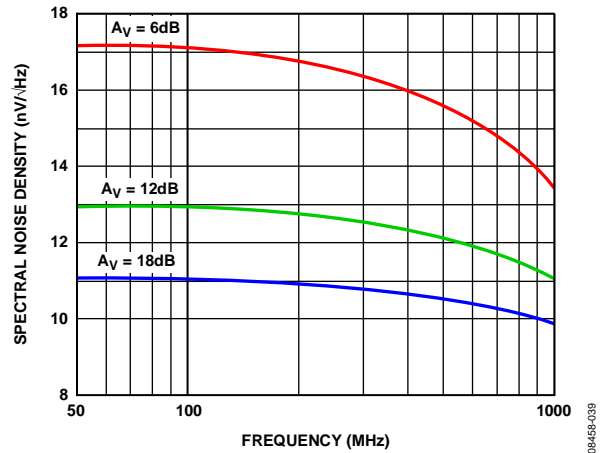

Figure 8. RTO Noise Spectral Density vs. Frequency at AV = 6 dB, AV = 12 dB, and AV = 18 dB

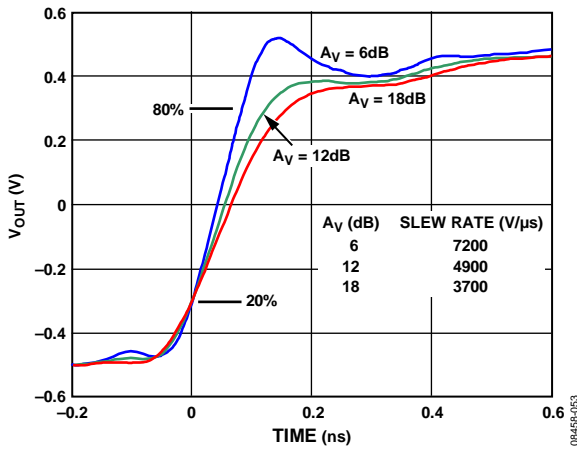

Figure 6. Rise Time, VOUT vs. Time, VOUT = 1 V p-p

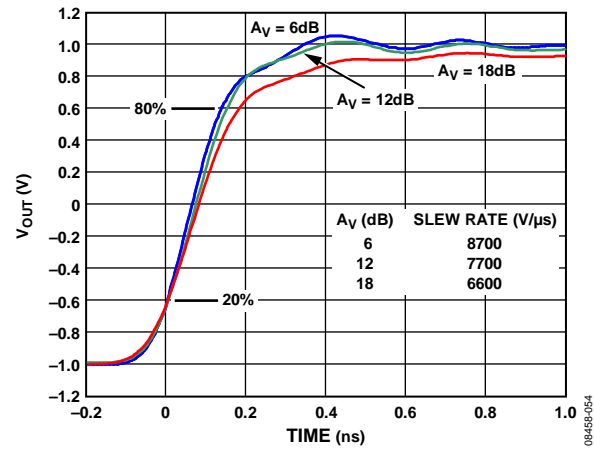

Figure 9. Rise Time, VOUT vs. Time, VOUT = 2 V p-p

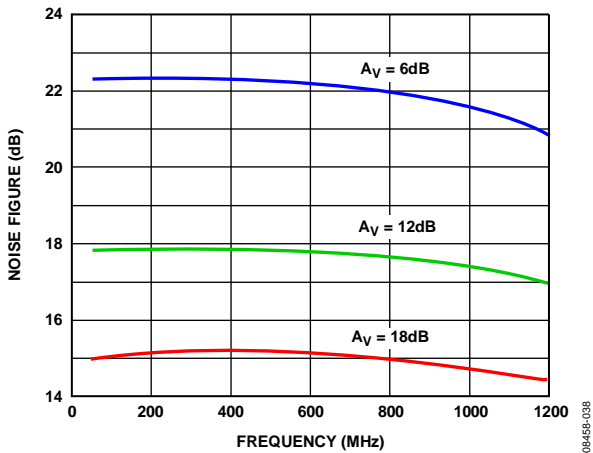

Figure 7. Noise Figure vs. Frequency at AV = 6 dB, AV = 12 dB, and AV = 18 dB

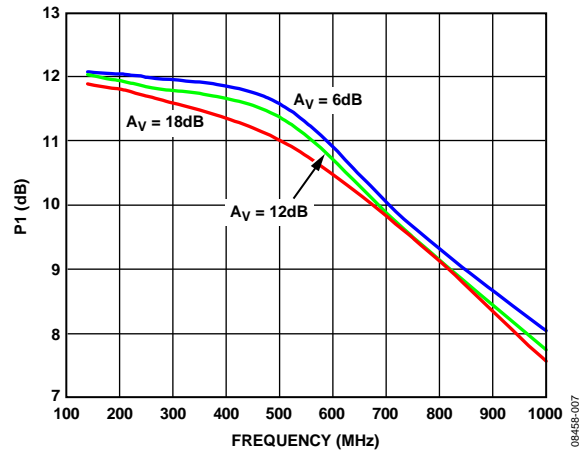

Figure 10. P1 dB vs. Frequency at AV = 6 dB, AV = 12 dB, and AV = 18 dB



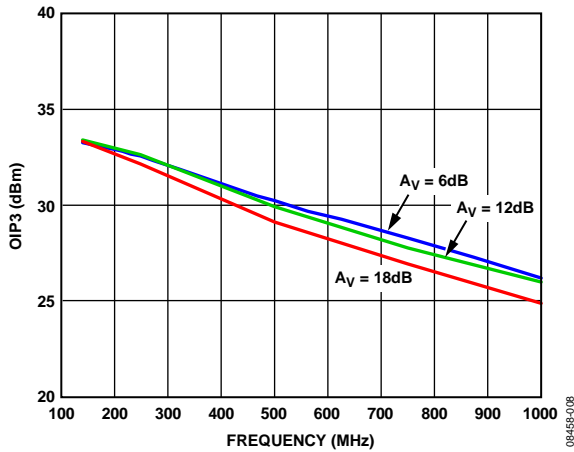

Figure 11. OIP3 vs. Frequency at  $A_V = 6$  dB,  $A_V = 12$  dB, and  $A_V = 18$  dB,  $V_{OUT} = 0.45$  V p-p/Tone, 2 MHz Spacing

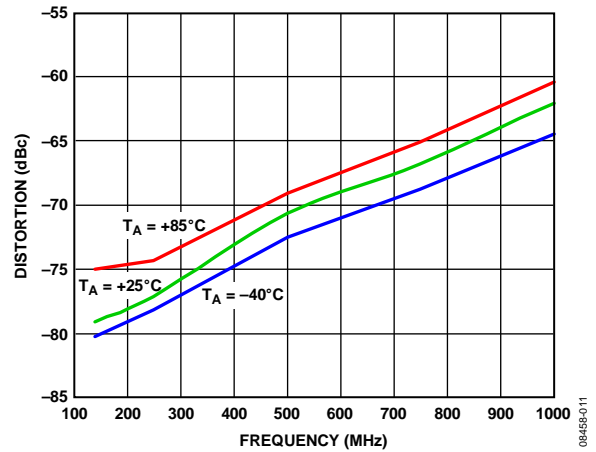

Figure 14. Two Tone IMD3 vs. Frequency at  $T_A = -40^\circ\text{C}$ ,  $T_A = +25^\circ\text{C}$ , and  $T_A = +85^\circ\text{C}$ ,  $A_V = 6$  dB,  $V_{OUT} = 0.45$  V p-p/Tone, 2 MHz Spacing

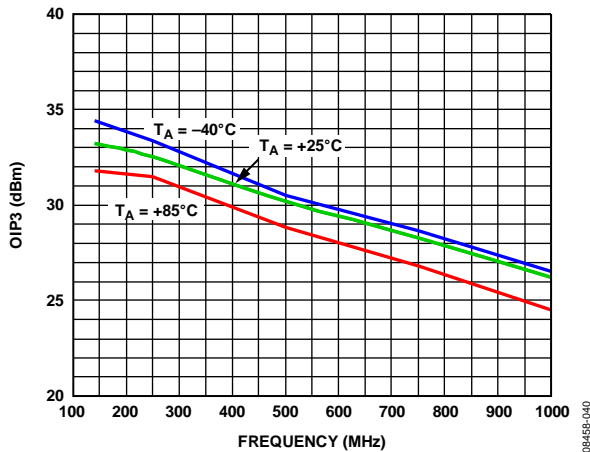

Figure 12. OIP3 vs. Frequency at  $A_V = 6$  dB,  $T_A = -40^\circ\text{C}$ ,  $T_A = +25^\circ\text{C}$ , and  $T_A = +85^\circ\text{C}$ ,  $V_{OUT} = 0.45$  V p-p/Tone, 2 MHz Spacing

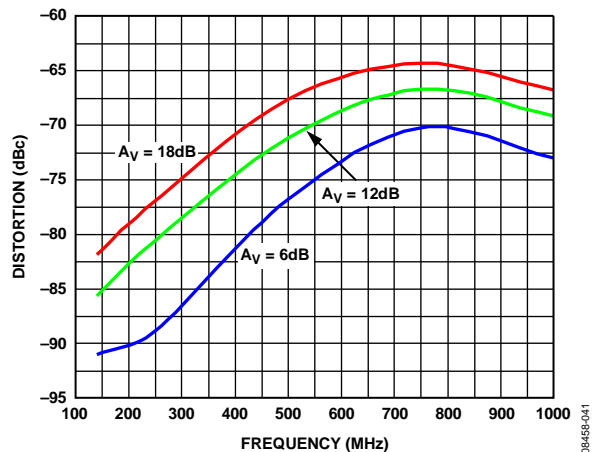

Figure 15. HD2 vs. Frequency at  $A_V = 6$  dB,  $A_V = 12$  dB, and  $A_V = 18$  dB,  $V_{OUT} = 0.9$  V p-p

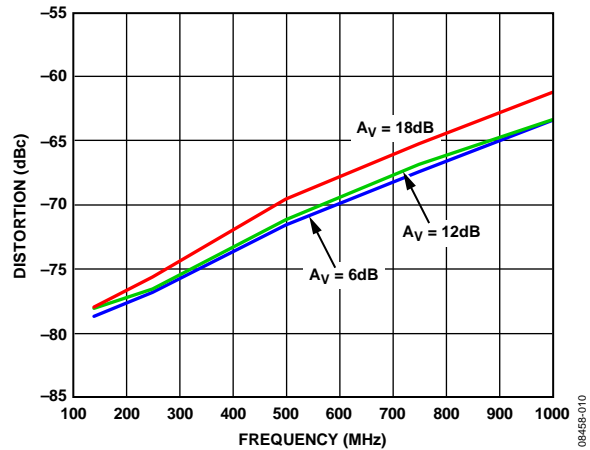

Figure 13. Two Tone IMD3 vs. Frequency,  $A_V = 6$  dB,  $A_V = 12$  dB, and  $A_V = 18$  dB,  $V_{OUT} = 0.9$  V p-p/Tone, 2 MHz Spacing

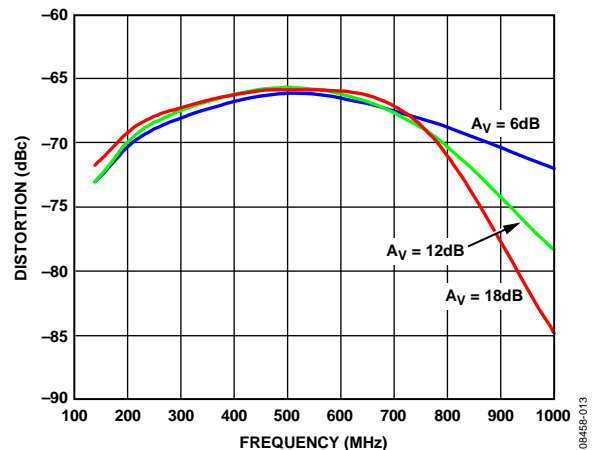

Figure 16. HD3 vs. Frequency at  $A_V = 6$  dB,  $A_V = 12$  dB, and  $A_V = 18$  dB,  $V_{OUT} = 0.9$  V p-p

# ADA4960-1

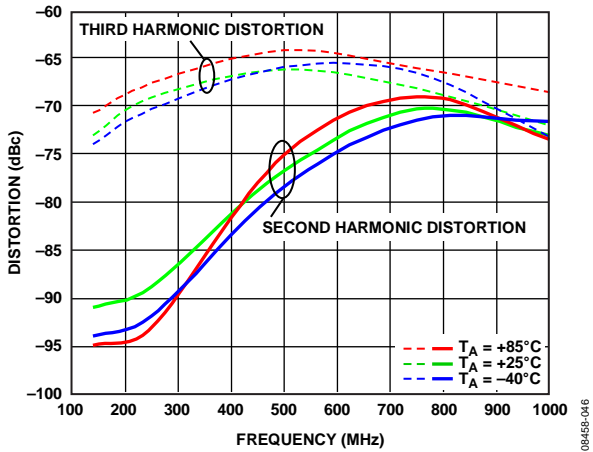

Figure 17. HD2 and HD3 vs. Frequency at  $T_A = -40^\circ\text{C}$ ,  $+25^\circ\text{C}$ ,  $+85^\circ\text{C}$ ,  $A_V = 6\text{ dB}$ ,  $V_{OUT} = 0.9\text{ V p-p}$

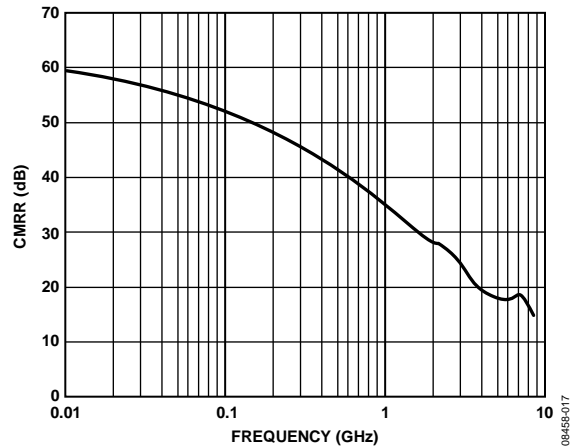

Figure 20. CMRR vs. Frequency,  $A_V = 6\text{ dB}$ ,  $V_{OUT} = 0.9\text{ V p-p}$

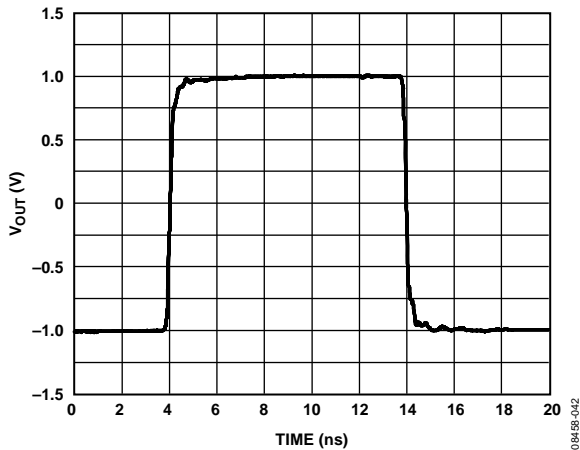

Figure 18. Large Signal Pulse Response,  $A_V = 18\text{ dB}$

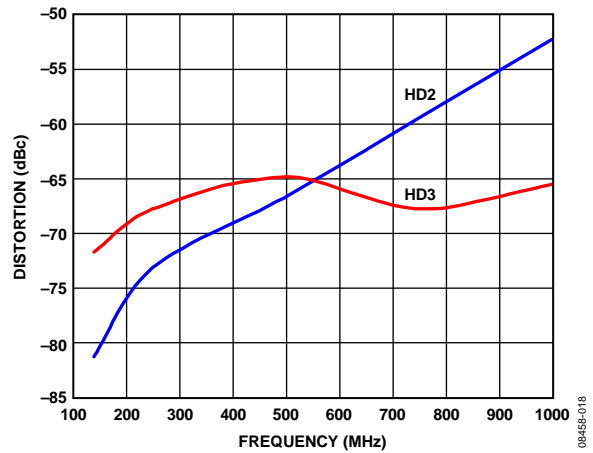

Figure 21. HD2/HD3 vs. Frequency, Single-Ended Input,  $A_V = 6\text{ dB}$ ,  $V_{OUT} = 0.9\text{ V p-p}$

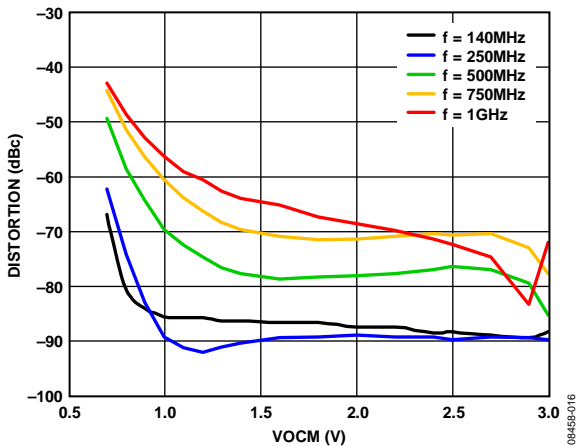

Figure 19. HD2 vs. VOCM,  $A_V = 6\text{ dB}$ ,  $V_{OUT} = 0.9\text{ V p-p}$ ,  $f = 140\text{ MHz}$ ,  $f = 250\text{ MHz}$ ,  $f = 500\text{ MHz}$ ,  $f = 750\text{ MHz}$ ,  $f = 1\text{ GHz}$

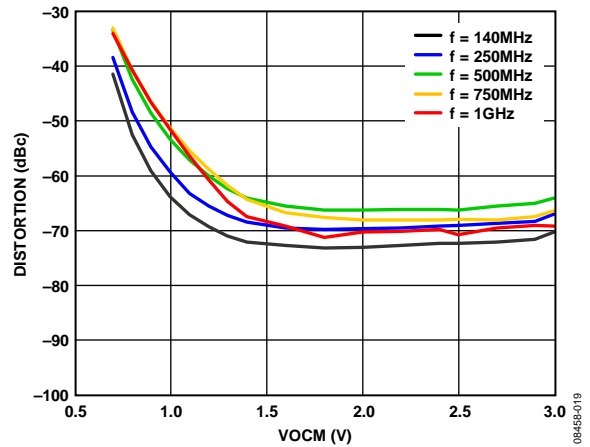

Figure 22. HD3 vs. VOCM,  $A_V = 6\text{ dB}$ ,  $V_{OUT} = 0.9\text{ V p-p}$ ,  $f = 140\text{ MHz}$ ,  $f = 250\text{ MHz}$ ,  $f = 500\text{ MHz}$ ,  $f = 750\text{ MHz}$ ,  $f = 1\text{ GHz}$

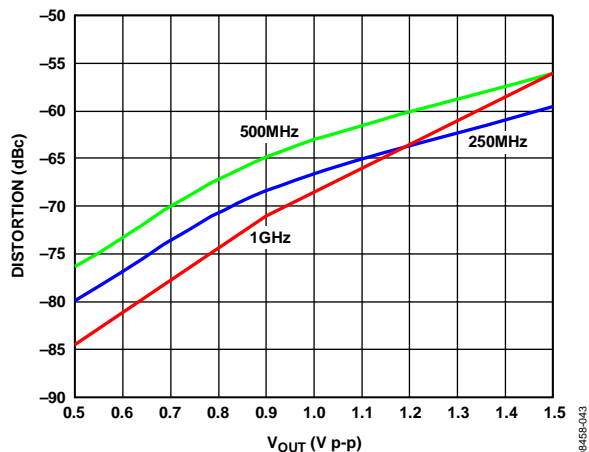

Figure 23. HD3 vs. Output Amplitude @ 250 MHz, 500 MHz, 1 GHz,  $A_V = 6$  dB,  $V_{OUT} = 0.9$  V p-p

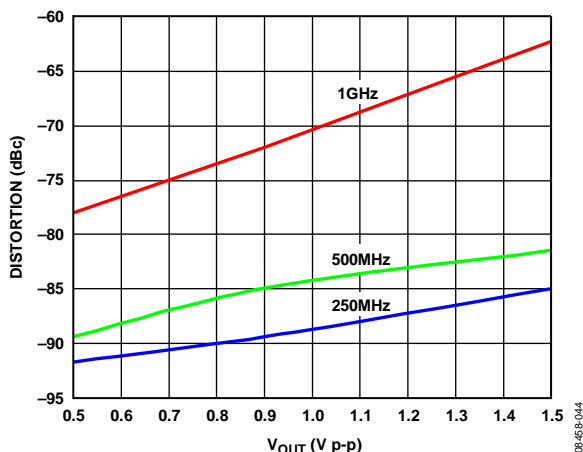

Figure 25. HD2 vs.  $V_{OUT}$  @ 250 MHz, 500 MHz, and 1 GHz,  $A_V = 6$  dB,  $V_{OUT} = 0.9$  V p-p

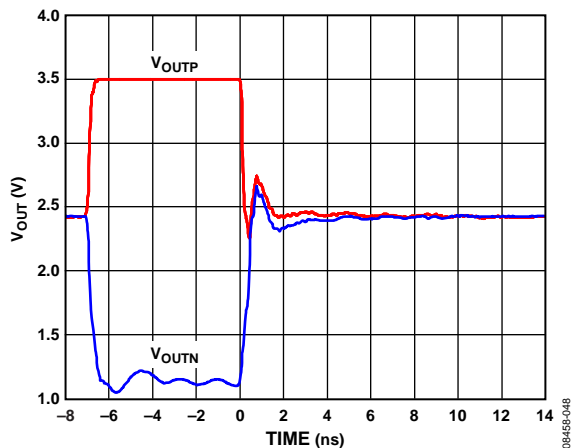

Figure 24. Output Overdrive,  $V_{OUT}$  vs. Time,  $V_{IN} = 1$  V p-p,  $A_V = 12$  dB

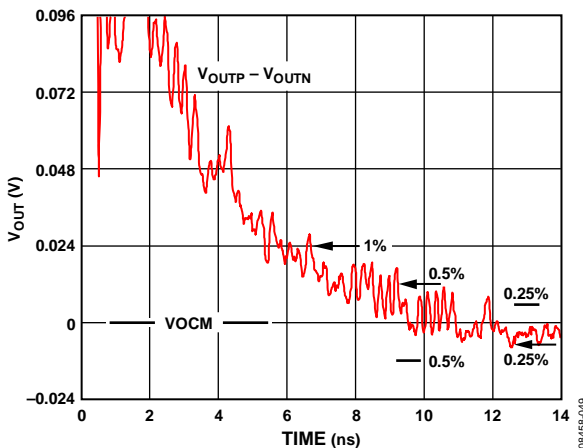

Figure 26. Output Overdrive Recovery,  $V_{OUT}$  vs. Time,  $V_{IN} = 1$  V p-p,  $A_V = 12$  dB,  $V_{OCM} = 2.4$  V

# ADA4960-1

## TEST CIRCUITS

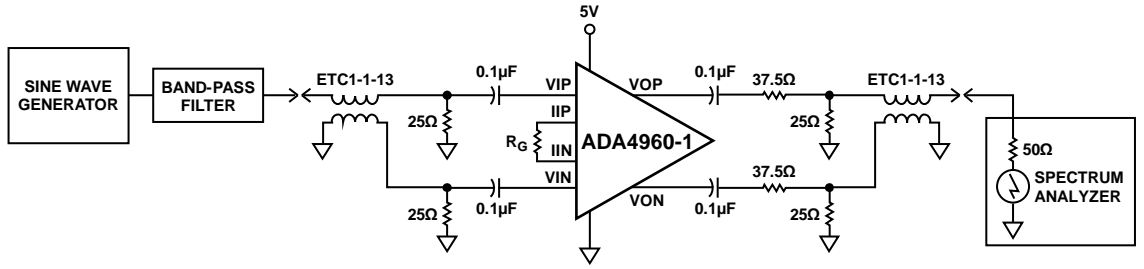

Figure 27. Distortion Test Circuit

0845B-022

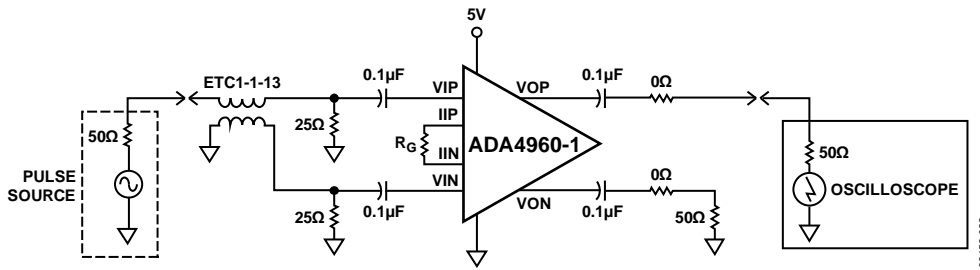

Figure 28. Time Domain Test Circuit

0845B-023

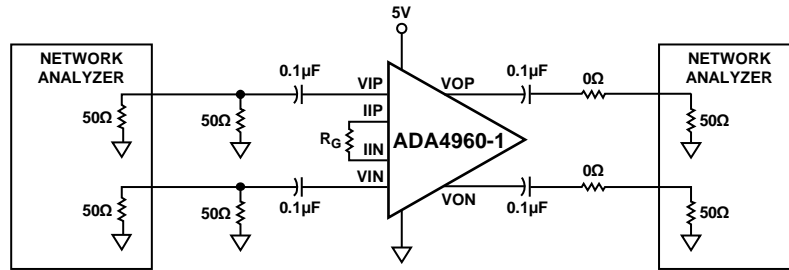

Figure 29. S-Parameter Test Circuit

0845B-024

## CIRCUIT DESCRIPTION

### BASIC STRUCTURE

The ADA4960-1 is a low noise, fully differential amplifier/ADC driver that uses a single 5 V supply at 60 mA. This amplifier has buffered inputs that isolate the gain-setting resistor ( $R_G$ ) from the input signals, keeping a constant 10 k $\Omega$  differential input impedance for all gains.

The differential output impedance is 150  $\Omega$ . The gain range is 0 dB to 18 dB and is set using a single resistor ( $R_G$ ).

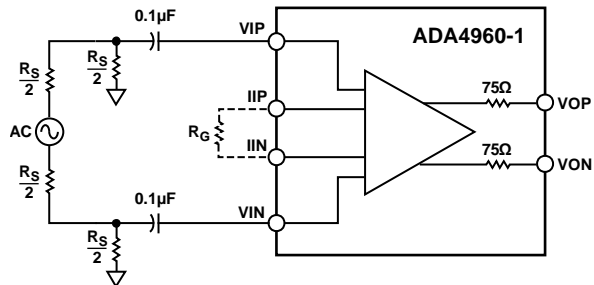

Figure 30. Basic Structure of the ADA4960-1

The ADA4960-1 can be ac-coupled or dc-coupled at the inputs and/or outputs within the specified input and output common-mode range.

The inputs, VIP and VIN, have a common-mode voltage range of 2.25 V to 2.75 V and are internally set at  $V_{CC}/2$ . The outputs, VOP and VON, have a common-mode voltage range of 1.0 V to 2.75 V that can be set externally using the VO $CM$  pin. The VO $CM$  pin is internally set to  $V_{CC}/2$  with no external connection.

The input of the device can be configured as single-ended or differential with similar HD3 distortion results.

## APPLICATIONS INFORMATION

### BASIC CONNECTIONS

The basic connections for operating the ADA4960-1 are shown in Figure 33. Connect VCC to 5 V and decouple each supply pin with a low inductance surface-mount ceramic capacitor of 0.1  $\mu\text{F}$  placed as close to the device as possible.

In addition, decouple the VOCM pin and the VCI pin by using a 0.1  $\mu\text{F}$  capacitor, whether or not they are used as inputs.

For normal operation, the enable pin (PD) should be tied to VCC. When the ADA4960-1 is pulled low, it goes into power-down mode. The VOP and VON outputs are internally biased at  $V_{CC}/2$  with no external source. The output common-mode range can be adjusted in the range of 1 V to 2.75 V by applying an external source voltage to the VCOM pin.

### INPUT AND OUTPUT INTERFACING

The ADA4960-1 can be configured as a differential-input-to-differential-output driver, as shown in Figure 31.

The differential broadband input is provided by the ETC1-1-13 balun transformer. The two 25  $\Omega$  resistors, R1 and R2, provide the 50  $\Omega$  match to the 50  $\Omega$  ac source. The 0.1  $\mu\text{F}$  capacitors, connected in series with the inputs and outputs, isolate the source and balanced load from the internal bias.  $R_G$  is the gain-setting resistor. Load  $R_L$  should equal 100  $\Omega$  to provide the expected ac performance (see the Specifications section). Different loads can be applied with the gain value described by the gain adjust equation (see the Gain Adjust section).

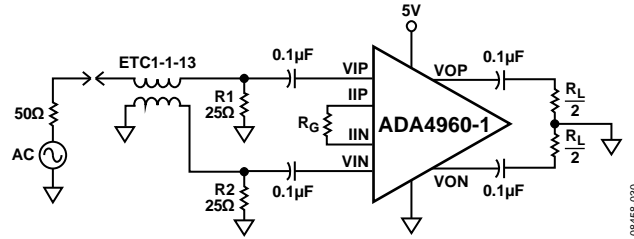

Figure 31. Differential-Input-to-Differential-Output Configuration

The ADA4960-1 can also be configured as a single-ended-input-to-differential-output driver, as shown in Figure 32. R1 provides the input source match, and R2 balances the input source impedances. The 0.1  $\mu\text{F}$  capacitors, connected in series with the inputs and outputs, isolate the source and balanced load from the internal bias.  $R_G$  is the gain-setting resistor.  $R_L$  should equal 100  $\Omega$  to provide the expected ac performance (see the Specifications section).

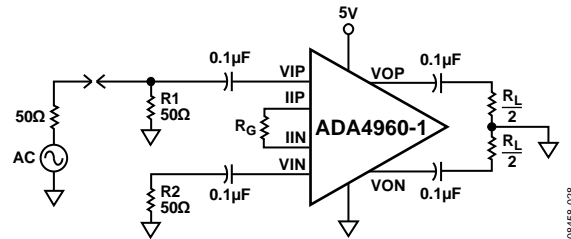

Figure 32. Single-Ended-Input-to-Differential-Output Configuration

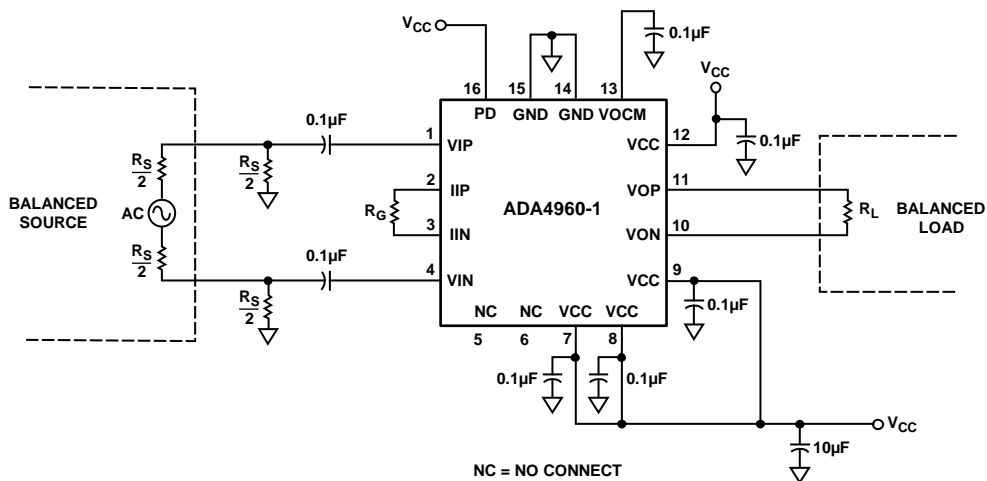

Figure 33. Basic Connections of the ADA4960-1

**GAIN ADJUST**

The gain of the ADA4960-1 is set with a single resistor,  $R_G$ , connected across the IIP and IIN pins. Because the output impedance is  $150\ \Omega$ , the load affects the gain. The voltage gain can be calculated for both differential and single-ended inputs as follows:

$$A_V = 4.7 \frac{\left( \frac{150R_L}{150 + R_L} \right)}{(35.5 + R_G)}$$

where  $R_L$  and  $R_G$  are the load and gain-setting resistors.

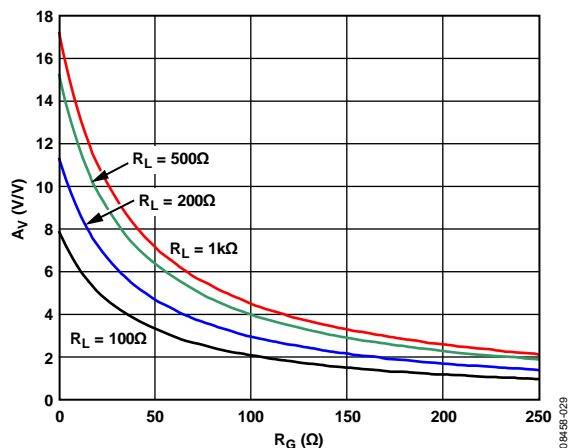

Figure 34.  $A_V$  vs.  $R_G$  for  $R_L = 100\ \Omega$ ,  $R_L = 200\ \Omega$ ,  $R_L = 500\ \Omega$ , and  $R_L = 1\ k\Omega$

**Table 5.  $A_V$  vs.  $R_G$  for  $R_L = 100\ \Omega$ ,  $R_L = 200\ \Omega$ ,  $R_L = 500\ \Omega$ , and  $R_L = 1\ k\Omega$**

$A_V$ (dB)	$R_G$			
	$R_L = 100\ \Omega$	$R_L = 200\ \Omega$	$R_L = 500\ \Omega$	$R_L = 1\ k\Omega$
0	246	370	505	576
6	106	167	237	271
12	35.2	65.7	101	118
18	0	15.2	32.8	41.7

**BANDWIDTH EXTENSION**

The bandwidth of the ADA4960-1 can be extended for both differential and single-ended input configurations by connecting a capacitor,  $C_S$ , in parallel with the gain-setting resistor,  $R_G$ , as shown in Figure 35.

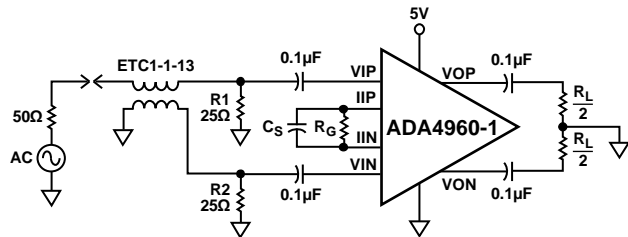

Figure 35. ADA4960-1 with Bandwidth Extension

Figure 36 shows the bandwidth extension for 6 dB and 12 dB gains. Figure 37 shows the recommended  $C_S$  values for most gains (dB).

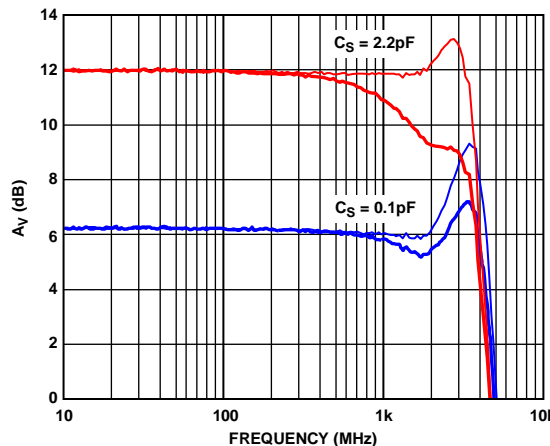

Figure 36. Bandwidth Extension for 6 dB and 12 dB Gains

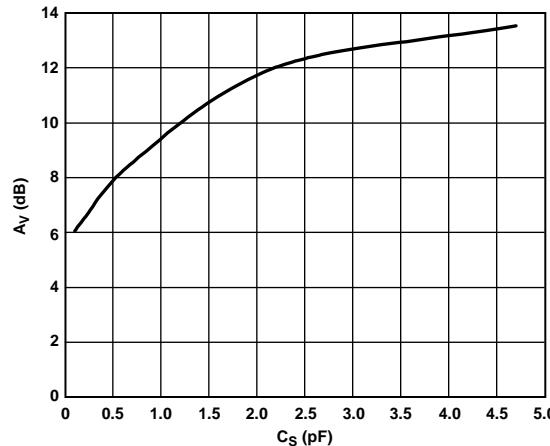

Figure 37. Recommended  $C_S$  Values for Most Gains

# ADA4960-1

## ADC INTERFACING

The ADA4960-1 is a high speed amplifier with linearity performance to drive high speed ADCs up to 1 GHz. Several options are available to the designer to interface with an ADC.

The ADA4960-1 in Figure 38 is a differential input configuration, using an input balun to provide the differential input signal. The 25  $\Omega$  resistors provide the input source match. The ADA4960-1 outputs can be directly connected to the ADC inputs as long as the ADC input common mode is within the output common-mode range of the ADA4960-1. The ADC  $V_{CM}$  output pin is connected to the ADA4960-1 VO<sub>CM</sub> input pin to align the ADA4960-1 output voltages with the ADC inputs.

A 100  $\Omega$  resistor across the outputs of the ADA4960-1 enhances system bandwidth and distortion performance when the ADA4960-1 is driving an ADC with high input impedance. Lighter load resistance improves distortion performance and lowers the overall bandwidth.

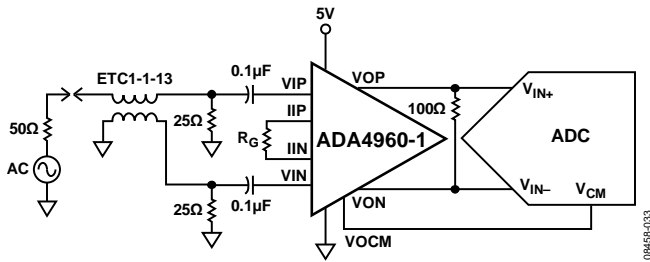

Figure 38. Differential Input Configuration Directly Driving the ADC

The ADA4960-1 in Figure 39 is a single-ended input configuration. The input is matched to the source with 50  $\Omega$  resistors. The ADA4960-1 outputs can be directly connected to the ADC inputs as long as the ADC input common mode is within the output common-mode range of the ADA4960-1.

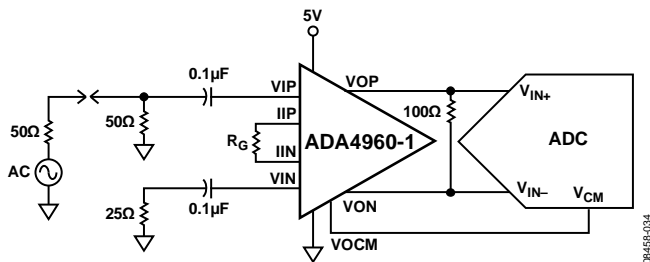

Figure 39. Single-Ended Input Configuration Directly Driving the ADC

The signal source can be directly connected to the ADA4960-1 inputs as long as the source dc level is within the common-mode input range of the ADA4960-1, as shown in Figure 40.

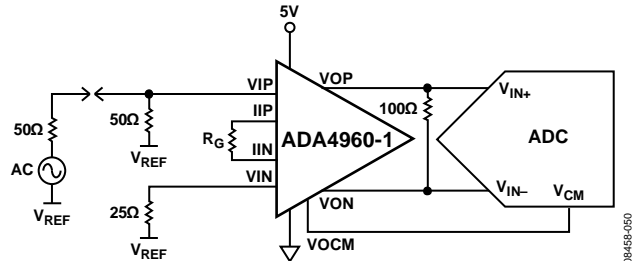

Figure 40. Single-Ended Input Configuration, DC-Coupled Inputs and Outputs

When the ADC input common mode is outside the output common-mode range of the ADA4960-1, the outputs can be ac-coupled to provide coupling, as shown in Figure 41.

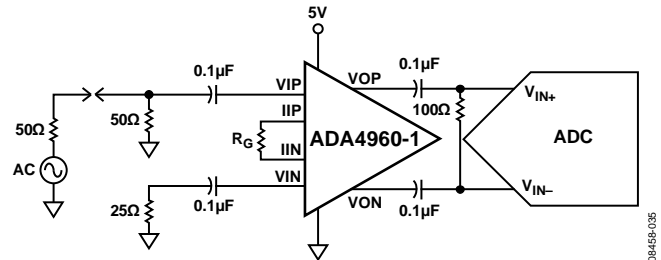

Figure 41. Single-Ended Input Configuration, AC-Coupled to the ADC

## LINE DRIVER APPLICATIONS

The user accessible gain adjust and bandwidth extension features allow configuration of the ADA4960-1 for line driver and channel equalization applications from dc to 6.5 Gbps.

Because of its extremely low distortion performance and high linearity, the ADA4960-1 can be deployed in cable and backplane channels to extend channel length and improve signaling margin for serial links using receive equalization and transmit pre-emphasis. The ADA4960-1 unidirectional signal path is protocol and encoding agnostic, supporting myriad signaling types such as NRZ and PAM2/4/8/N, coded (8b/10b), uncoded, and out-of-band (SATA-OOB) data.



**OVERDRIVE AND RECOVERY**

When overdriven, the ADA4960-1 limits its outputs to 3.4 V typical with no overshoot, as shown in Figure 42. This feature protects the ADC from transients, eliminating the need for additional external clamping at the inputs of the ADC.

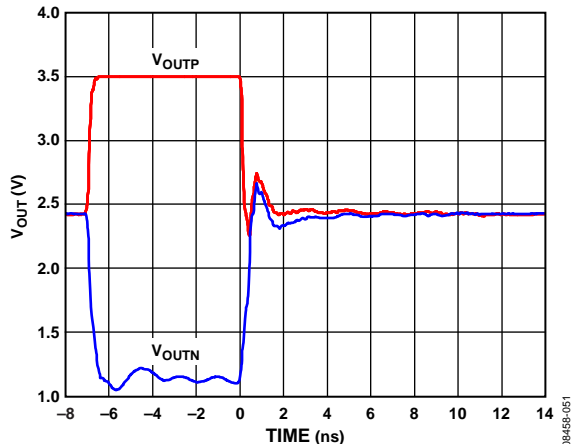

Figure 42. Output Overdrive,  $V_{IN} = 1\text{ V p-p}$ ,  $A_V = 12\text{ dB}$

Recovery from overdrive is 6.7 ns to 1%, 9.3 ns to 0.5%, and 12.6 ns to 0.25% of the final output voltage, see Figure 43.

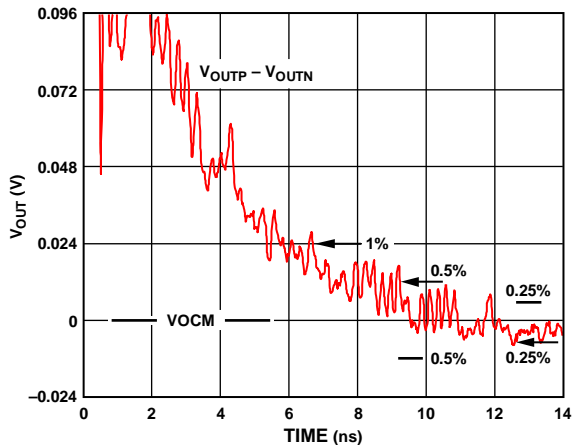

Figure 43. Output Overdrive Recovery

## LAYOUT, GROUNDING, AND BYPASSING

The ADA4960-1 is a high speed device. Realizing its superior performance requires attention to the details of high speed printed circuit board (PCB) design.

The first requirement is to use a multilayer PCB with solid ground and power planes that cover as much of the board area as possible.

Bypass each power supply pin directly to a nearby ground plane, as close to the device as possible. Use 0.1  $\mu\text{F}$  high frequency ceramic chip capacitors.

Provide low frequency bulk bypassing, using 10  $\mu\text{F}$  tantalum capacitors from each supply to ground.

Stray transmission line capacitance in combination with package parasitics can potentially form a resonant circuit at high frequencies, resulting in excessive gain peaking or possible oscillation.

Signal routing should be short and direct to avoid such parasitic effects. Provide symmetrical layout for complementary signals to maximize balanced performance.

Use radio frequency transmission lines to connect the driver and receiver to the amplifier.

Minimize stray capacitance at the input/output pins by clearing the underlying ground and low impedance planes near these pins.

If the driver/receiver is more than one-eighth of the wavelength from the amplifier, the signal trace widths should be minimal. This nontransmission line configuration requires the underlying and adjacent ground and low impedance planes to be cleared near the signal lines.

The exposed thermal paddle is internally connected to the ground pin of the amplifier. Solder the paddle to the low impedance ground plane on the PCB to ensure the specified electrical performance and to provide thermal relief. To reduce thermal impedance further, it is recommended that the ground planes on all layers under the paddle be connected together with vias.

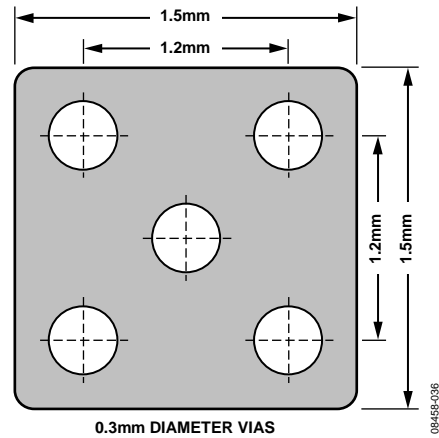

Figure 44. Recommended PCB Thermal Attach Pad

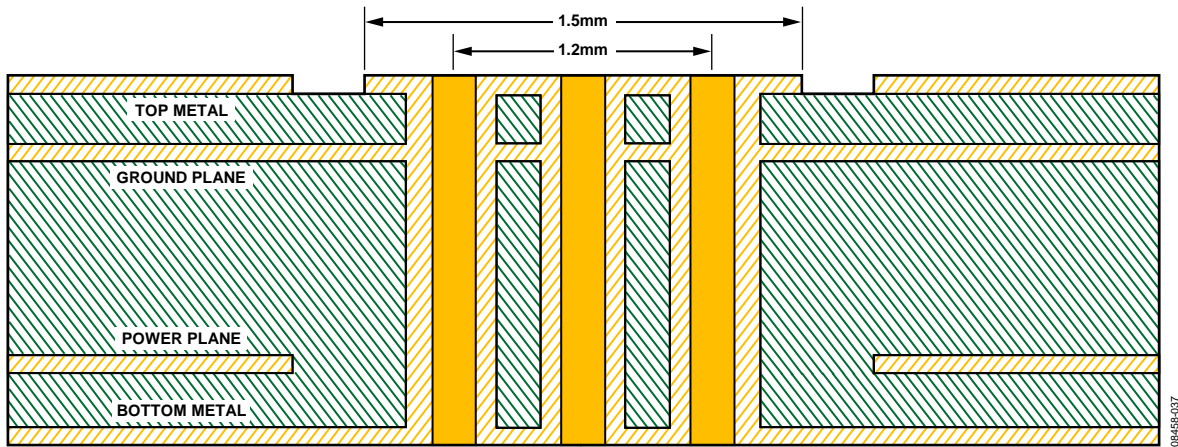
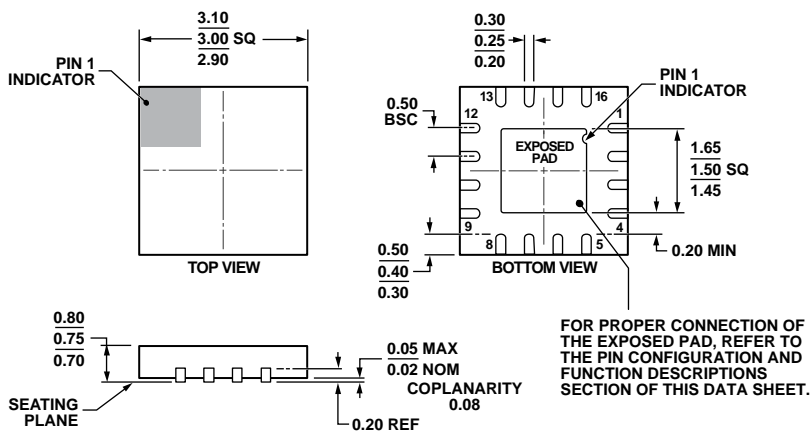

Figure 45. Cross-Section of a 4-Layer PCB Showing Thermal Via Connection to Buried Ground Plane

# OUTLINE DIMENSIONS



COMPLIANT TO JEDEC STANDARDS MO-229.

Figure 46. 16-Lead Lead Frame Chip Scale Package [LFCSP\_WQ]  
 3 mm × 3 mm Body, Very Very Thin Quad  
 (CP-16-27)  
 Dimensions shown in millimeters

091605-A

## ORDERING GUIDE

Model <sup>1</sup>	Temperature Range	Package Description	Package Option	Ordering Quantity	Branding
ADA4960-1ACPZ-R2	-40°C to +85°C	16-Lead Lead Frame Chip Scale Package [LFCSP_WQ]	CP-16-27	250	H23
ADA4960-1ACPZ-RL	-40°C to +85°C	16-Lead Lead Frame Chip Scale Package [LFCSP_WQ]	CP-16-27	5,000	H23
ADA4960-1ACPZ-R7	-40°C to +85°C	16-Lead Lead Frame Chip Scale Package [LFCSP_WQ]	CP-16-27	1,500	H23

<sup>1</sup> Z = RoHS Compliant Part.

**ADA4960-1**

**NOTES**

Компания «Life Electronics» занимается поставками электронных компонентов импортного и отечественного производства от производителей и со складов крупных дистрибьюторов Европы, Америки и Азии.

С конца 2013 года компания активно расширяет линейку поставок компонентов по направлению коаксиальный кабель, кварцевые генераторы и конденсаторы (керамические, пленочные, электролитические), за счёт заключения дистрибьюторских договоров

Мы предлагаем:

- Конкуренеспособные цены и скидки постоянным клиентам.
- Специальные условия для постоянных клиентов.
- Подбор аналогов.
- Поставку компонентов в любых объемах, удовлетворяющих вашим потребностям.
- Приемлемые сроки поставки, возможна ускоренная поставка.
- Доставку товара в любую точку России и стран СНГ.
- Комплексную поставку.
- Работу по проектам и поставку образцов.
- Формирование склада под заказчика.
- Сертификаты соответствия на поставляемую продукцию (по желанию клиента).
- Тестирование поставляемой продукции.
- Поставку компонентов, требующих военную и космическую приемку.
- Входной контроль качества.
- Наличие сертификата ISO.

В составе нашей компании организован Конструкторский отдел, призванный помогать разработчикам, и инженерам.

Конструкторский отдел помогает осуществить:

- Регистрацию проекта у производителя компонентов.
- Техническую поддержку проекта.
- Защиту от снятия компонента с производства.
- Оценку стоимости проекта по компонентам.
- Изготовление тестовой платы монтаж и пусконаладочные работы.



Тел: +7 (812) 336 43 04 (многоканальный)  
Email: [org@lifeelectronics.ru](mailto:org@lifeelectronics.ru)