

# Power Line Filters

*Compact design requires minimal real estate and delivers excellent filtering characteristics for both differential and common mode. RoHS compliant, easily installed for a broad array of applications.*



|  |           |
|--|-----------|
| Appliance Filters .....                        | PF50-PF53 |
| Single Stage.....                              | PF54-PF69 |
| With Wire Leads .....                          | PF56-PF57 |
| With Wire Leads for Medical Applications ..... | PF58-PF59 |
| Higher Current .....                           | PF66-PF69 |
| DC – Higher Current .....                      | PF70-PF71 |
| Dual Stage.....                                | PF72-PF79 |

# Power Line Filters Appliance Filters



## 11-MPC Series

### Features

- Miniature general purpose PCB mounted filter
- Requires minimal PCB real estate space
- Low cost
- Operating temperature: -25°C to +70°C
- Two forms of cases are available: metal case and plastic case

### Applications

- Personal computers and peripherals
- Digital equipment
- Measuring instruments and medical equipment
- TV & VCR monitors and display units
- Home appliances

### Circuit Diagram

Circuit 1

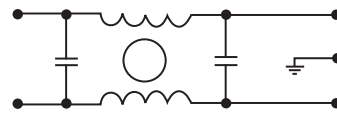

Circuit 2

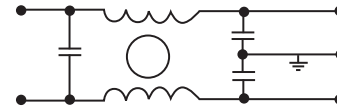

Circuit 3

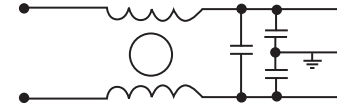

Circuit 4

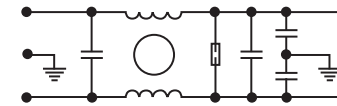

### Specifications

| Model          | Rated Voltage (@ 50/60Hz) | Rated Current | Leakage Current (Max.) | Circuit Diagram | Figure | Temperature Rise (Max.) |
|----------------|---------------------------|---------------|------------------------|-----------------|--------|-------------------------|
| 11-MPC-001-2-B | 120/250VAC                | 1A            | 0.50mA                 | 1               | A1     | 30°C                    |
| 11-MPC-001-5-A |                           |               |                        | A               |        |                         |
| 11-MPC-001-5-B |                           |               |                        | A1              |        |                         |
| 11-MPC-002-5-B |                           | 2A            |                        | D               |        |                         |
| 11-MPC-002-5-D |                           |               |                        |                 | E      |                         |
| 11-MPC-003-5-E |                           |               |                        |                 | A1     |                         |
| 11-MPC-006-5-B |                           | 6A            |                        | C               |        |                         |
| 11-MPC-006-5-C |                           |               |                        |                 |        |                         |
| 11-MPC-016-5-B |                           |               |                        |                 | B      |                         |
|                |                           | 16A           | 0.2mA                  | 4               |        |                         |

Note: Test voltage: 1500VAC one minute, line to ground  
 Insulation resistance: 300 Mohm min. at 500VDC  
 Voltage drop: 1V max. at rated current  
 Weight: 17.5g

# PCB Power Filters Miniature Printed Circuit Board

## 11-MPC Series

**Figure A**



**Figure A1**



**Figure B**



**Figure C**



**Figure D**

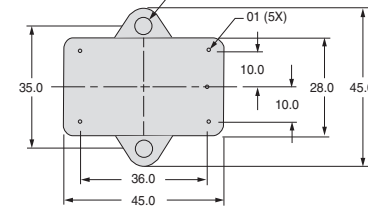
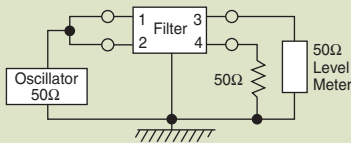

**Figure E**



Dimensions in inches (mm)

### Common Mode



#### 11-MPC-001;-002



#### 11-MPC-003;-006;-016



### Normal Mode



#### 11-MPC-001;-002



#### 11-MPC-003;-006;-016



# Power Line Filters Appliance Filters

## 62-AL/62-AC Series

### Features

- Low-cost plastic case
- Compact design requires minimal real estate space
- Suitable for products that must conform to FCC regulations
- Wide variety of circuit and filtering options
- Good filtering characteristics for both normal mode and common mode
- Epoxy molded for reliability
- Operating temperature: -25°C to +85°C (including temperature rise, see graph on page PF53)

### Applications

- Personal computers and peripherals
- Digital equipment
- Industrial equipment
- Vending machines
- Home appliances
- Office equipment

### Specifications

| Model*          | Rated Voltage (@ 50/60Hz) | Rated Current | Leakage Current (Max.) | Capacitance    |                | Inductance (L <sub>1</sub> ) | Temperature Rise (Max.) |
|-----------------|---------------------------|---------------|------------------------|----------------|----------------|------------------------------|-------------------------|
|                 |                           |               |                        | C <sub>Y</sub> | C <sub>X</sub> |                              |                         |
| 62-AFL-010-3-11 | 250VAC                    | 1.0A          | 0.35mA                 | 2200pF         | 0.1uF          | 11.0mH                       | 40°C                    |
| 62-AFC-010-3-11 |                           |               | 0.50mA                 | 3300pF         |                |                              |                         |
| 62-AFL-010-5-11 |                           |               | 0.35mA                 | 2200pF         |                |                              |                         |
| 62-AFC-010-5-11 |                           |               |                        | 3300pF         |                |                              |                         |
| 62-AFL-016-3-11 |                           | 1.6A          | 0.35mA                 | 2200pF         |                | 6.0mH                        |                         |
| 62-AFC-016-3-11 |                           |               |                        | 3300pF         |                |                              |                         |
| 62-AFL-016-5-11 |                           | 0.35mA        | 0.50mA                 | 2200pF         |                | 2.4mH                        |                         |
| 62-AFC-016-5-11 |                           |               |                        | 3300pF         |                |                              |                         |
| 62-AFL-030-3-11 |                           | 3.0A          | 0.35mA                 | 2200pF         |                | 1.0mH                        |                         |
| 62-AFC-030-3-11 |                           |               |                        | 3300pF         |                |                              |                         |
| 62-AFL-030-5-11 |                           | 0.35mA        | 0.50mA                 | 2200pF         |                | 0.53mH                       |                         |
| 62-AFC-030-5-11 |                           |               |                        | 3300pF         |                |                              |                         |
| 62-AFL-045-3-11 |                           | 4.5A          | 0.35mA                 | 2200pF         |                | 0.53mH                       |                         |
| 62-AFC-045-3-11 |                           |               |                        | 3300pF         |                |                              |                         |
| 62-AFL-045-5-11 |                           | 0.35mA        | 0.50mA                 | 2200pF         |                | 0.53mH                       |                         |
| 62-AFC-045-5-11 |                           |               |                        | 3300pF         |                |                              |                         |
| 62-AFL-060-3-11 |                           | 6.0A          | 0.35mA                 | 2200pF         |                | 0.53mH                       |                         |
| 62-AFC-060-3-11 |                           |               |                        | 3300pF         |                |                              |                         |
| 62-AFL-060-5-11 |                           | 0.35mA        | 0.50mA                 | 2200pF         |                | 0.53mH                       |                         |
| 62-AFC-060-5-11 |                           |               |                        | 3300pF         |                |                              |                         |

Note: All types are designed to meet the requirement of UL 1283, CSA 22.2. VDE 0565-3  
 Test voltage: 1500VAC one minute, line to ground  
 Insulation resistance: 300 Mohm min. at 500VDC  
 Voltage drop: 1V max.

\* Available with bleeder resistor  
 Replace F with R for part number



### Circuit Diagrams



# Power Line Filters Appliance Filters

## 62-AL/62-AC Series

### Common Mode



**62-AFL-xxx-3-11**



**62-AFC-XXX-3-11**



**62-AFL-xxx-5-11**



**62-AFC-xxx-5-11**



## Temperature Characteristics



### Normal Mode



**62-AFL-XXX-3-11**



**62-AFC-XXX-3-11**



**62-AFL-xxx-5-11**



**62-AFC-xxx-5-11**



# Power Line Filters Single Stage

## 62-PPF/PQF/PRF Series



Tested and found to be  
IAW VDE 0565 Part 3

### Features

- Low-cost plastic case
- Compact design requires minimal real estate space
- Suitable for products that must conform to FCC and FTZ regulations
- Wide variety of circuit and filtering options
- Good filtering characteristics for both normal mode and common mode
- Epoxy molded for reliability
- Operating temperature: -25°C to +85°C (including temperature rise, see graph on page PF55)

### Applications

- Personal computers and peripherals
- Digital equipment
- Industrial equipment
- Vending machines
- Office equipment



### Circuit Diagrams



\* Bleeder Resistor is available only for  
62-P(Q/R/P)F-XXX-X-12

### Specifications

| Model           | Rated Voltage<br>(@ 50/60Hz) | Rated<br>Current | Leakage Current<br>(Max.) | Capacitance    |                | Inductance<br>(L <sub>1</sub> ) | Temperature<br>Rise (Max.) |      |       |
|-----------------|------------------------------|------------------|---------------------------|----------------|----------------|---------------------------------|----------------------------|------|-------|
|                 |                              |                  |                           | C <sub>Y</sub> | C <sub>X</sub> |                                 |                            |      |       |
| 62-PQF-020-5-11 | 250VAC                       | 2A               | 0.50mA                    | 3300pF         | 0.1uF          | 15mH                            | 30°C                       |      |       |
| 62-PQF-020-5-12 |                              |                  |                           |                | .22uF          |                                 |                            |      |       |
| 62-PPF-020-5-11 |                              |                  |                           |                | 0.1uF          |                                 |                            | 8mH  |       |
| 62-PPF-020-5-12 |                              |                  |                           |                | .22uF          |                                 |                            |      |       |
| 62-PQF-030-5-11 |                              |                  |                           |                | 0.1uF          |                                 |                            |      | 2.1mH |
| 62-PQF-030-5-12 |                              |                  |                           |                | .22uF          |                                 |                            |      |       |
| 62-PPF-030-5-11 |                              | 0.1uF            |                           |                | 486uH          |                                 |                            |      |       |
| 62-PPF-030-5-12 |                              | .22uF            |                           |                |                |                                 |                            |      |       |
| 62-PQF-060-5-11 |                              | 0.1uF            |                           |                |                | 181uH                           |                            |      |       |
| 62-PQF-060-5-12 |                              | .22uF            |                           |                |                |                                 |                            |      |       |
| 62-PPF-060-5-11 |                              | 0.1uF            |                           |                |                |                                 |                            | 97uH |       |
| 62-PPF-060-5-12 |                              | .22uF            |                           |                |                |                                 |                            |      |       |
| 62-PRF-010-5-11 |                              | 1A               |                           |                | 3A             |                                 |                            |      |       |
| 62-PRF-010-5-12 |                              | .22uF            |                           |                |                |                                 |                            |      |       |
| 62-PRF-020-5-11 |                              | 2A               |                           |                |                | 3A                              |                            |      |       |
| 62-PRF-020-5-12 |                              | .22uF            |                           |                |                |                                 |                            |      |       |
| 62-PRF-030-5-11 |                              | 3A               |                           |                |                |                                 |                            | 3A   |       |
| 62-PRF-030-5-12 |                              | .22uF            |                           |                |                |                                 |                            |      |       |

Note: All types are designed to meet the requirement of UL 1283, CSA 22.2, VDE 0565-3

Test voltage: 1500VAC one minute, line to ground  
 Insulation resistance: 300 Mohm min. at 500VDC  
 Voltage drop: 1V max. (except 62-PRF-010-5-11) at rated current  
 62-PRF-010-5-11: 1.5V max. at rated current  
 Weight: 62-PPF & PQF Series: 2.11 ounces (60 grams)  
 62-PRF Series: 1.76 ounces (50 grams)

# Power Line Filters Single Stage

## 62-PPF/PQF/PRF Series

### Temperature Characteristics



Also available with .250 Fast-ons

Dimensions in inches (mm)

### Normal Mode



#### 62-PQF Series



#### 62-PPF Series



### Common Mode



#### 62-P(Q/R)F Series



#### 62-PRF Series



# Power Line Filters Single Stage Wire Leads



## 62-PML Series



Tested and found to be  
IAW VDE 0565 Part 3

### Features

- Compact design requires minimal real estate space
- Suitable for products that must conform to FCC and FTZ regulations
- Excellent attenuation for high voltage impulse
- Metal case provides effective shielding
- Excellent filtering characteristics for both normal mode and common mode
- Structure provides effective shielding for noise generated externally and internally
- Operating temperature: -25°C to +85°C (including temperature rise, see graph on page PF57)

### Applications

- Digital equipment
- Personal computers and peripherals
- Measuring instruments
- Medical equipment
- Factory automation equipment

### Circuit Diagram



## Specifications

| Model           | Rated Voltage<br>(@ 50/60Hz) | Rated Current | Leakage Current<br>(Max.) | Capacitance    |                | Inductance<br>(L <sub>1</sub> ) | Temperature<br>Rise (Max.) |
|-----------------|------------------------------|---------------|---------------------------|----------------|----------------|---------------------------------|----------------------------|
|                 |                              |               |                           | C <sub>Y</sub> | C <sub>X</sub> |                                 |                            |
| 62-PML-015-3-11 | 250VAC                       | 1.5A          | 0.35mA                    | 2200pF         | 0.1uF          | 10.0mH                          | 30°C                       |
| 62-PML-015-5-11 |                              |               | 0.50mA                    | 3300pF         |                | 4.3mH                           |                            |
| 62-PML-030-3-11 |                              | 3A            | 0.35mA                    | 2200pF         |                | 2.4mH                           |                            |
| 62-PML-030-5-11 |                              |               | 0.50mA                    | 3300pF         |                |                                 |                            |
| 62-PML-050-3-11 |                              | 5A            | 0.35mA                    | 2200pF         |                |                                 |                            |
| 62-PML-050-5-11 |                              |               | 0.50mA                    | 3300pF         |                |                                 |                            |

Note: All types are designed to meet the requirement of UL 1283, CSA 22.2. VDE 0565-3  
 Test voltage: 1500VAC one minute, line to ground  
 Insulation resistance: 300 Mohm min. at 500VDC  
 Voltage drop: 1V max. at rated current  
 Weight: 62-PML-015 Series: 3.06 ounces (87 grams)  
           62-PML-030 Series: 3.17 ounces (90 grams)  
           62-PML-050 Series: 3.28 ounces (93 grams)  
 Discharge time: 0.4 sec. max.



# Power Line Filters Single Stage Wire Leads

## 62-PML Series

### Temperature Characteristics



### Common Mode

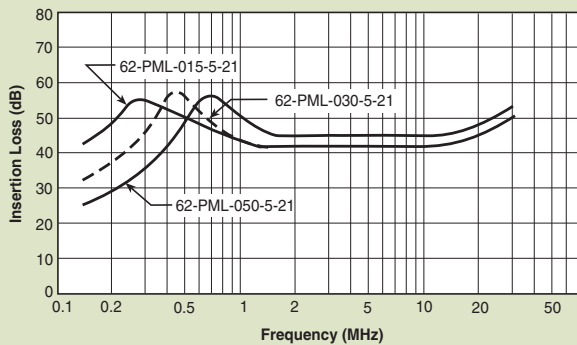
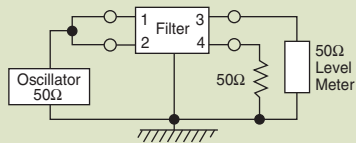

### Normal Mode

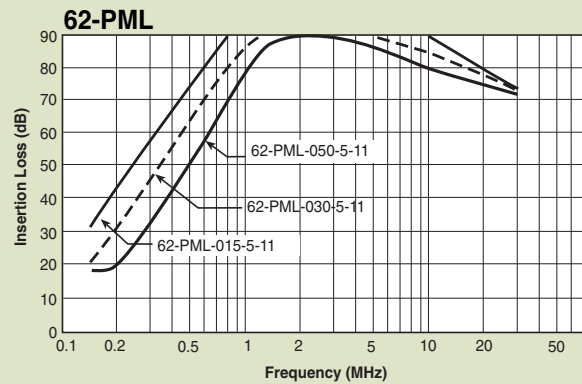
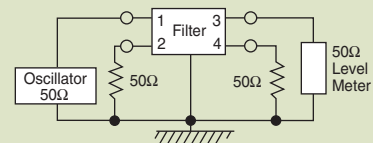

# Power Line Filters Single Stage Wire Leads

for Medical Purpose Applications

## 12-PML & 12-PMF Series



### Features

- Compact design requires minimal real estate space
- Suitable for products that must conform to FCC and FTZ regulations
- Excellent attenuation for high voltage impulse
- Metal case provides effective shielding
- Excellent filtering characteristics for both normal mode and common mode
- Structure provides effective shielding for noise generated externally and internally
- Operating temperature: -25°C to +70°C
- Low leakage current

### Applications

- Digital equipment
- Personal computers and peripherals
- Measuring instruments
- Medical equipment
- Factory automation equipment



### Circuit Diagram

Circuit 1



Circuit 2

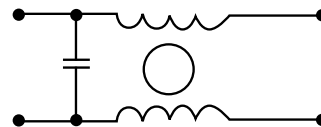

### Specifications

| Model          | Rated Voltage (@ 50/60Hz) | Rated Current | Leakage Current (Max.) | Circuit Diagram | Figure | Temperature Rise (Max.) |
|----------------|---------------------------|---------------|------------------------|-----------------|--------|-------------------------|
| 12-PML-001-2-A | 120/250VAC                | 1A            | 5uA                    | 1               | A      | 30°C                    |
| 12-PML-002-2-A |                           | 2A            |                        |                 |        |                         |
| 12-PML-006-2-A |                           | 6A            |                        |                 |        |                         |
| 12-PML-010-2-A |                           | 10A           |                        | 2               | B      |                         |
| 12-PMF-001-2-B |                           | 1A            |                        |                 |        |                         |
| 12-PMF-002-2-B |                           | 2A            |                        |                 |        |                         |
| 12-PMF-006-2-B |                           | 6A            |                        | 1               | C      |                         |
| 12-PML-001-2-C |                           | 1A            |                        |                 |        |                         |

Note: All types are designed to meet the requirement of UL 1283, CSA 22.2. VDE 0565-3  
 Test voltage: 1500VAC one minute, line to ground  
 Insulation resistance: 300 Mohm min. at 500VDC  
 Voltage drop: 1V max. at rated current  
 Discharge time: 0.4 sec. max.

# Power Line Filters Single Stage Wire Leads

for Medical Purpose Applications

## 12-PML & 12-PMF Series

**Figure A**



**Figure C**



**Figure B**



Dimensions in inches (mm)

### Common Mode



#### 12-PML-001;-002;-006;-010



#### 12-PMF-001;-002;-006;-010



### Normal Mode



#### 12-PML-001;-002;-006;-010



#### 12-PMF-001;-002;-006;-010



# Power Line Filters Single Stage



## 62-LMF & LMB Series



Tested and found to be  
IAW VDE 0565 Part 3

### Features

- Space saving, compact designs
- Suitable for products that must conform to FCC and FTZ regulations
- Excellent filtering characteristics for both normal mode and common mode
- Structure provides effective shielding for noise generated externally and internally
- Metal case provides effective shielding
- Rugged construction
- Operating temperature: -25°C to +85°C (including temperature rise, see graph on page PF61)

### Applications

- Digital equipment
- Office automation equipment, such as copy and fax machines
- Computers and peripherals
- Instrumentation and controls

### Circuit Diagram



## Specifications

| Model*          | Rated Voltage<br>(@ 50/60Hz) | Rated Current | Leakage Current<br>(Max.) | Capacitance    |                | Inductance<br>(L <sub>1</sub> ) | Temperature Rise (Max.) |
|-----------------|------------------------------|---------------|---------------------------|----------------|----------------|---------------------------------|-------------------------|
|                 |                              |               |                           | C <sub>Y</sub> | C <sub>X</sub> |                                 |                         |
| 62-LMB-030-5-11 | 250VAC                       | 3A            | 0.50mA                    | 3300pF         | 0.1uF          | 14mH                            | 45°C                    |
| 62-LMF-030-5-11 |                              | 5A            |                           |                | 0.1uF & .22uF  | 7.0mH                           |                         |
| 62-LMB-050-5-11 |                              |               |                           |                | 8A             | .22uF                           |                         |
| 62-LMF-050-5-11 |                              | 10A           |                           |                |                | .33uF                           |                         |
| 62-LMB-080-5-11 |                              |               |                           |                | .33uF          | 2.2mH                           |                         |
| 62-LMF-080-5-11 |                              |               |                           |                |                |                                 |                         |
| 62-LMB-100-5-11 |                              |               |                           |                |                |                                 |                         |
| 62-LMF-100-5-11 |                              |               |                           |                |                |                                 |                         |

Note: Test voltage: 1500VAC one minute, line to ground  
Insulation resistance: 300 Mohm min. at 500VDC  
Voltage drop: 1V max. at rated current  
Discharge time: 0.4 sec. max.  
Weight: 5.3 ounces (150 grams)

\*62-LMF - designates Fast-on terminals  
62-LMB - designates Bolt-in terminals  
62-LML - wire lead in/outputs also available

# Power Line Filters Single Stage

## 62-LMF & LMB Series

### Temperature Characteristics



### 62-LMB



### 62-LMF



Dimensions in inches (mm)

### Common Mode



### Normal Mode



### 62-LMF & LMB



### 62-LMF & LMB



# Power Line Filters Single Stage



## 62-PMF & PMB Series



Tested and found to be  
IAW VDE 0565 Part 3

### Features

- Space-saving, compact designs
- Suitable for products that must conform to FCC regulations
- Excellent attenuation for high voltage impulse
- Metal case provides effective EMI shielding
- Excellent filtering characteristics for both normal mode and common mode
- Epoxy molded for internal component reliability
- Structure provides effective shielding for noise generated externally and internally
- Operating temperature: -25°C to +85°C (including temperature rise, see graph on page PF63)

### Applications

- Digital equipment
- Computers and peripherals
- Measuring instruments
- Medical equipment
- Equipment requiring very high impulse attenuation
- Factory automation equipment
- Industrial equipment such as UPS, inverters and converters
- Telecommunications equipment
- Office automation equipment, such as copy and fax machines

### Circuit Diagram



## Specifications

| Model*          | Rated Voltage (@ 50/60Hz) | Rated Current | Leakage Current (Max.) | Capacitance    |                | Inductance (L <sub>1</sub> ) | Temperature Rise (Max.) |        |
|-----------------|---------------------------|---------------|------------------------|----------------|----------------|------------------------------|-------------------------|--------|
|                 |                           |               |                        | C <sub>Y</sub> | C <sub>X</sub> |                              |                         |        |
| 62-PMB-050-5-11 | 250VAC                    | 5A            | 0.50mA                 | 3300pF         | 0.1uF          | 14mH                         | 30°C                    |        |
| 62-PMF-050-5-11 |                           |               |                        |                |                |                              |                         |        |
| 62-PMB-080-5-11 |                           | 8A            |                        |                |                |                              |                         | 7.0mH  |
| 62-PMF-080-5-11 |                           |               |                        |                |                |                              |                         |        |
| 62-PMB-100-5-12 |                           | 10A           |                        |                |                | 4.2mH                        |                         | 35°C   |
| 62-PMF-100-5-12 |                           |               |                        |                |                |                              |                         |        |
| 62-PMB-150-5-13 |                           | 15A           |                        |                |                | 2.2mH                        |                         |        |
| 62-PMF-150-5-13 |                           |               |                        |                |                |                              |                         |        |
| 62-PMB-200-5-13 |                           | 20A           |                        |                |                | 1.8mH                        |                         | 45°C** |
| 62-PMF-200-5-13 |                           |               |                        |                |                |                              |                         |        |

Note: Test voltage: 1500VAC one minute, line to ground  
Insulation resistance: 300 Mohm min. at 500VDC  
Voltage drop: 1V max.  
Discharge time: 0.4 sec. max.  
Weight: 8.82 ounces ( 250 grams)

\* PMF - designates Fast-on terminals  
PMB - designates Bolt-in terminals

\*\* The temperature rise of 20 amp units can be decreased to 30°C by mounting on 200 X 200 x 1.0(mm) steel chassis

# Power Line Filters Single Stage

## 62-PMF & PMB Series

### Temperature Characteristics



### 62-PMF



### 62-PMB



| MODEL              | A             | B            | C            |
|--------------------|---------------|--------------|--------------|
| 62-PMF/PMB-100-200 | 1.490<br>(38) | .944<br>(24) | .433<br>(11) |
| 62-PMF/PMB-050-080 | 1.258<br>(32) | .786<br>(20) | 0<br>(0)     |

Dimensions in inches (mm)

### Common Mode



### Normal Mode



# Power Line Filters Single Stage

## 12-PMF Series



### Features

- Space-saving, compact designs
- Suitable for products that must conform to FCC regulations
- Excellent attenuation for high voltage impulse
- Metal case provides effective EMI shielding
- Excellent filtering characteristics for both normal mode and common mode
- Epoxy molded for internal component reliability
- Structure provides effective shielding for noise generated externally and internally
- Operating temperature: -25°C to +85°C

### Applications

- Digital equipment
- Computers and peripherals
- Measuring instruments
- Medical equipment
- Equipment requiring very high impulse attenuation
- Factory automation equipment
- Industrial equipment such as UPS, inverters and converters
- Telecommunications equipment
- Office automation equipment, such as copy and fax machines



### Circuit Diagram

Circuit 1



Circuit 2



Circuit 3



Circuit 4



Circuit 5



Circuit 6



### Specifications

| Model          | Rated Voltage (@ 50/60Hz) | Rated Current | Leakage Current (Max.) | Circuit Diagram | Figure | Temperature Rise (Max.) |
|----------------|---------------------------|---------------|------------------------|-----------------|--------|-------------------------|
| 12-PMF-001-5-A | 120/250VAC                | 1A            | 0.5mA                  | 1               | A      | 30°C                    |
| 12-PMF-002-5-B |                           | 2A            |                        | 2               | B      |                         |
| 12-PMF-003-5-A |                           | 3A            |                        | 4               | A      |                         |
| 12-PMF-003-5-B |                           | 2             |                        | B               |        |                         |
| 12-PMF-006-5-A |                           | 4             |                        | A               |        |                         |
| 12-PMF-006-5-C |                           | 1             |                        | C               |        |                         |
| 12-PMF-006-5-D |                           | 6             |                        | D               |        |                         |
| 12-PMF-010-5-A |                           | 10A           |                        | 2               | A      |                         |
| 12-PMF-010-5-C |                           | 3             |                        | C               |        |                         |
| 12-PMF-015-5-C |                           | 15A           |                        | 5               | E      |                         |
| 12-PMF-015-5-E |                           | C             |                        |                 |        |                         |
| 12-PMF-020-5-C |                           | D             |                        |                 |        |                         |
| 12-PMF-020-5-D |                           | D             |                        |                 |        |                         |
| 12-PMF-020-5-E |                           | E             |                        |                 |        |                         |

Note: Test voltage: 1500VAC one minute, line to ground  
 Insulation resistance: 300 Mohm min. at 500VDC  
 Voltage drop: 1V max.  
 Discharge time: 0.4 sec. max.



# Power Line Filters Single Stage

## 12-PMF Series

Figure A



Figure B



Figure C



Figure D



Figure E



Dimensions in inches (mm)

### Common Mode



#### 12-PMF-001;-002;-003;-006

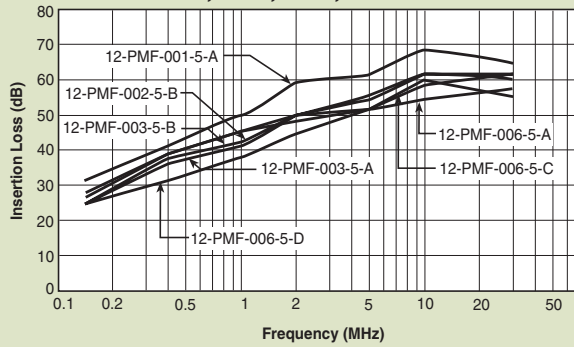

#### 12-PMF-001;-002;-003;-006



### Normal Mode



#### 12-PMF-001;-002;-003;-006



#### 12-PMF-010;-015;-020



# Power Line Filters Single Stage - Higher Current



## 62-PMB Series

### Features

- Space-saving, compact designs
- Suitable for products that must conform to FCC regulations
- Excellent attenuation for high voltage impulse
- Metal case provides effective shielding
- Excellent filtering characteristics for both normal mode and common mode
- Epoxy molded for internal component reliability
- Structure provides effective shielding for noise generated externally and internally
- Safety agency approvals pending
- Designed to be in accordance with VDE 0565 Part 3
- Operating temperature: -25°C to +85°C (including temperature rise)

### Applications

- Digital equipment
- Computers and peripherals
- Measuring instruments
- Medical equipment
- Equipment requiring very high impulse attenuation
- Factory automation equipment
- Industrial equipment such as UPS, inverters and converters
- Telecommunications equipment
- Office automation equipment, such as copy and fax machines

### Circuit Diagram



## Specifications

| Model           | Rated Voltage<br>(@ 50/60Hz) | Rated Current | Leakage Current<br>(Max.) | Capacitance    |                | Inductance<br>(L <sub>1</sub> ) | Temperature Rise<br>(Max.) |
|-----------------|------------------------------|---------------|---------------------------|----------------|----------------|---------------------------------|----------------------------|
|                 |                              |               |                           | C <sub>Y</sub> | C <sub>X</sub> |                                 |                            |
| 62-PMB-300-5-14 | 250VAC                       | 30A           | 0.50mA                    | 3300pF         | .47uF          | 1.6mH                           | 45°C                       |
| 62-PMB-400-5-14 |                              | 40A           |                           |                |                | 0.8mH                           |                            |

Note: Test voltage: 1500VAC one minute, line to earth  
 Insulation resistance: 300 Mohm min. at 500VDC  
 Voltage drop: 1V max.  
 Discharge time: 0.4 sec. max.  
 Weight: 8.82 ounces (250 grams)

# Power Line Filters Single Stage - Higher Current

## 62-PMB Series

### 62-PMB-300-5-14 and 62-PMB-400-5-14



Dimensions in inches (mm)

### Normal Mode



### Common Mode



# Power Line Filters Single Stage - Higher Current



## 12-PMB Series

### Features

- Space-saving, compact designs
- Suitable for products that must conform to FCC regulations
- Excellent attenuation for high voltage impulse
- Metal case provides effective shielding
- Excellent filtering characteristics for both normal mode and common mode
- Epoxy molded for internal component reliability
- Structure provides effective shielding for noise generated externally and internally
- Designed to be in accordance with VDE 0565 Part 3
- Operating temperature: -25°C to +85°C

### Applications

- Digital equipment
- Computers and peripherals
- Measuring instruments
- Medical equipment
- Equipment requiring very high impulse attenuation
- Factory automation equipment
- Industrial equipment such as UPS, inverters and converters
- Telecommunications equipment
- Office automation equipment, such as copy and fax machines

### Circuit Diagram



## Specifications

| Model          | Rated Voltage (@ 50/60Hz) | Rated Current | Leakage Current (Max.) | Circuit Diagram | Figure | Temperature Rise (Max.) |
|----------------|---------------------------|---------------|------------------------|-----------------|--------|-------------------------|
| 12-PMB-025-5-A | 120/250VAC                | 25A           | 0.5mA                  | 1               | A      | 30°C                    |
| 12-PMB-030-5-A |                           | 30A           |                        |                 |        |                         |
| 12-PMB-035-5-B |                           | 35A           |                        |                 |        |                         |
| 12-PMB-050-5-B |                           | 50A           |                        |                 |        |                         |
| 12-PMB-100-8-C |                           | 100A          | 1.0mA                  |                 |        |                         |
| 12-PMB-120-8-C |                           | 120A          |                        |                 |        |                         |

Note: Test voltage: 1500VAC one minute, line to earth  
 Insulation resistance: 300 Mohm min. at 500VDC  
 Voltage drop: 1V max.  
 Discharge time: 0.4 sec. max.  
 Weight: 8.82 ounces (250 grams)

# Power Line Filters Single Stage - Higher Current

## 12-PMB Series

**Figure A**



**Figure B**



**Figure C**



Dimensions in inches (mm)

### Common Mode



#### 12-PMB-025;-030;-035



#### 12-PMB-050;-100;-120



### Normal Mode



#### 12-PMB-025;-030;-035



#### 12-PMB-050;-100;-120



# Power Line Filters DC - Higher Current



## 12-PMF & 12 PMB DC Series

### Features

- Space-saving, compact designs
- Suitable for products that must conform to FCC regulations
- Excellent attenuation for high voltage impulse
- Metal case provides effective shielding
- Excellent filtering characteristics for both normal mode and common mode
- Epoxy molded for internal component reliability
- Structure provides effective shielding for noise generated externally and internally
- Designed to be in accordance with VDE 0565 Part 3
- Operating temperature: -40°C to +85°C

### Applications

- Digital equipment
- Computers and peripherals
- Measuring instruments
- Equipment requiring very high impulse attenuation
- Factory automation equipment
- Industrial equipment such as UPS, inverters and converters
- Telecommunications equipment

### Circuit Diagram

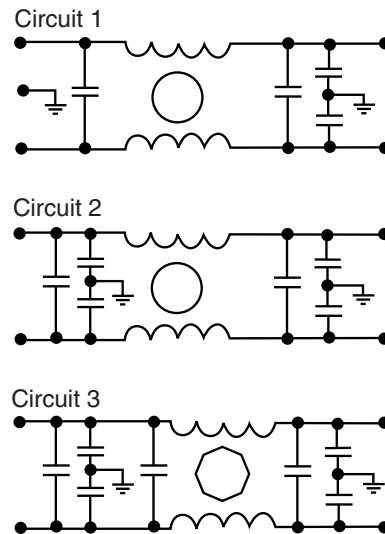

### Specifications

| Model           | Rated Voltage (@ 50/60Hz) | Rated Current | Circuit Diagram | Figure | Temperature Rise (Max.) |   |
|-----------------|---------------------------|---------------|-----------------|--------|-------------------------|---|
| 12-PMF-006-DC-C | 48/250 VDC                | 6A            | 1               | A      | 30°C                    |   |
| 12-PMF-010-DC-C |                           | 10A           |                 |        |                         |   |
| 12-PMF-015-DC-C |                           | 15A           |                 |        |                         |   |
| 12-PMF-020-DC-C |                           | 20A           |                 |        |                         |   |
| 12-PMF-025-DC-D |                           | 25A           |                 | 1      |                         | B |
| 12-PMB-025-DC-F |                           |               |                 |        |                         |   |
| 12-PMB-030-DC-F |                           | 30A           |                 | 1      |                         | C |
| 12-PMB-035-DC-F |                           | 35A           |                 |        |                         |   |
| 12-PMB-040-DC-F |                           | 40A           |                 |        |                         |   |
| 12-PMB-040-DC-B |                           | 40A           |                 |        |                         |   |
| 12-PMB-050-DC-B |                           | 50A           |                 | 1      |                         | D |
| 12-PMB-060-DC-B |                           | 60A           |                 |        |                         |   |
| 12-PMB-080-DC-G |                           | 80A           |                 | 2      |                         | E |
| 12-PMB-080-DC-C |                           |               |                 |        |                         |   |
| 12-PMB-100-DC-C |                           | 100A          | 3               | F      |                         |   |
| 12-PMB-120-DC-C |                           | 120A          |                 |        |                         |   |
| 12-PMB-140-DC-C |                           | 140A          |                 |        |                         |   |
| 12-PMB-180-DC-E |                           | 180A          | 2               | G      |                         |   |
| 12-PMB-200-DC-E |                           | 200A          |                 |        |                         |   |
| 12-PMB-260-DC-E |                           | 260A          |                 |        |                         |   |

Note: Test voltage: 1500VAC one minute, line to earth  
Insulation resistance: 300 Mohm min. at 500VDC  
Voltage drop: 1V max.

Discharge time: 0.4 sec. max.  
Weight: 8.82 ounces (250 grams)

# Power Line Filters DC - Higher Current

## 12-PMF & 12-PMB DC Series

**Figure B**



**Figure C**



**Figure A**



**Figure D**



**Figure E**



**Figure F**

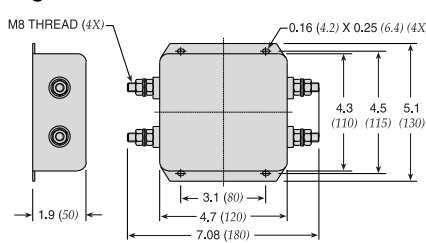

**Figure G**



Dimensions in inches (mm)

### Common Mode



#### 12-PMF-006;-010;-015;-020;-025



#### 12-PMB-025; thru -260



### Normal Mode



#### 12-PMF-006;-010;-015;-020;-025



#### 12-PMB-025; thru -260

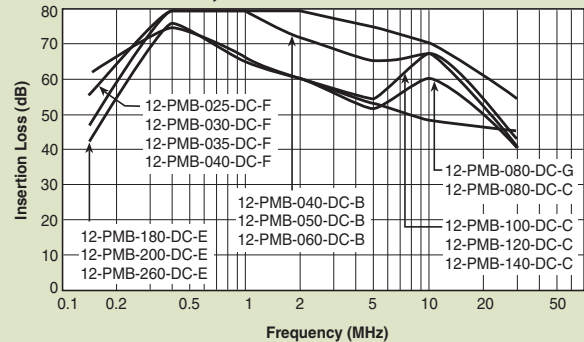

# Power Line Filters Dual Stage



## 62-MMF Series

### Features

- Suitable for products that must conform to FCC regulations
- Excellent attenuation for high voltage impulse
- Metal case provides effective EMI shielding
- Two stages for excellent filtering characteristics
- Epoxy molded for reliability
- Structure provides effective shielding for noise generated both externally and internally
- Operating temperature: -25°C to +85°C (including temperature rise, see graph on page PF73)

### Applications

- Digital equipment
- Personal computers and peripherals
- Measuring instruments and medical equipment
- Telecommunications equipment
- Equipment requiring very high noise attenuation

## Circuit Diagram

62-MMF-XXX-7-11



## Specifications

| Model           | Rated Voltage<br>(@ 50/60Hz) | Rated Current | Leakage Current<br>(Max.) | Capacitance     |                 |                | Inductance<br>(L <sub>1</sub> ) (2X) | Temperature<br>Rise (Max.) |
|-----------------|------------------------------|---------------|---------------------------|-----------------|-----------------|----------------|--------------------------------------|----------------------------|
|                 |                              |               |                           | C <sub>Y1</sub> | C <sub>Y2</sub> | C <sub>X</sub> |                                      |                            |
| 62-MMF-030-7-11 | 250VAC                       | 3A            | .7mA                      | 3300pF          | 1000pF          | 0.1uF          | 3.7mH                                | 30°C                       |
| 62-MMF-050-7-11 | 250VAC                       | 5A            | .7mA                      | 3300pF          | 1000pF          | 0.1uF          | 2.9mH                                | 30°C                       |

Note: All types are designed to meet the requirement of UL 1283, CSA 22.2, VDE 0565-3  
 Test voltage: 1500VAC one minute, line to ground  
 Insulation resistance: 300 Mohm min. at 500VDC  
 Leakage current: 0.7 mA max.  
 Voltage drop: 1V max.  
 Discharge time: 0.4 sec. max.  
 Weight: 6.0 ounces (170 grams)



# Power Line Filters Dual Stage

## 62-MMF Series

### Temperature Characteristics

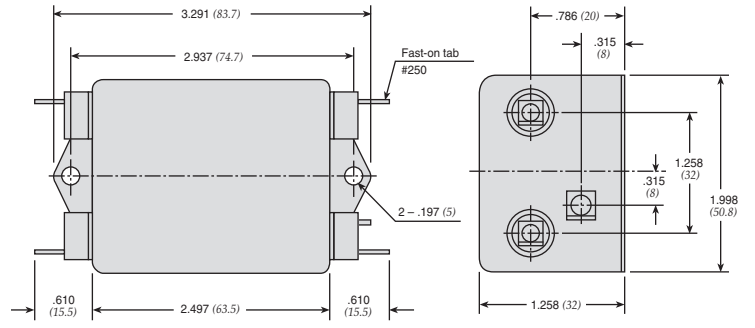
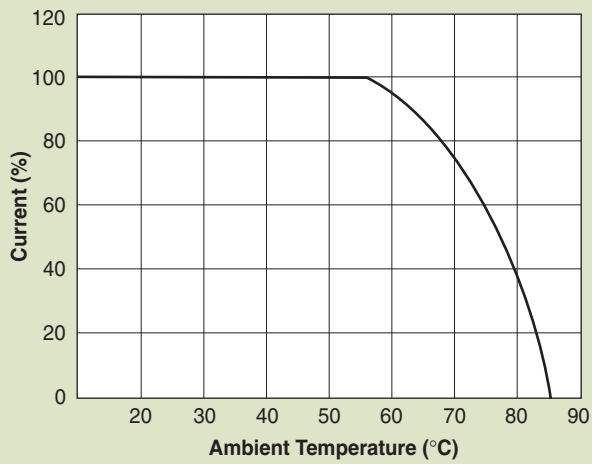

### Common Mode

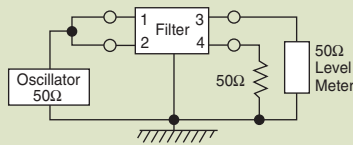

#### 62-MMF

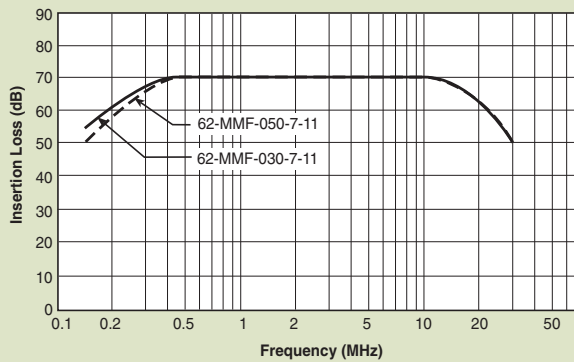

### Normal Mode



#### 62-MMF

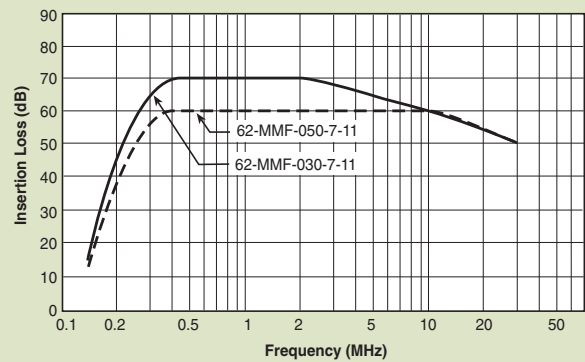

# Power Line Filters Dual Stage



## 12-MMF & 12-MMB Series

### Features

- Suitable for products that must conform to FCC regulations
- Excellent attenuation for high voltage impulse
- Metal case provides effective EMI shielding
- Two stages for excellent filtering characteristics
- Structure provides effective shielding for noise generated both externally and internally
- Operating temperature: -40°C to +85°C
- High performance
- Low leakage current

### Applications

- Digital equipment
- Switching power supplies
- Personal computers and peripherals
- Measuring instruments and medical equipment
- Telecommunications equipment
- Equipment requiring very high noise attenuation

### Circuit Diagram

Circuit 1

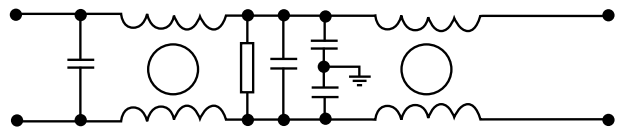

Circuit 2

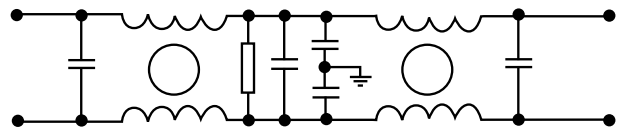

Circuit 3

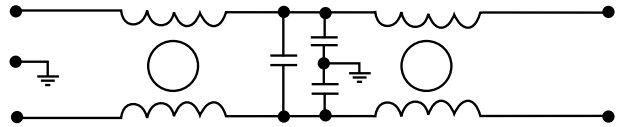

### Specifications

| Model          | Rated Voltage (@ 50/60Hz) | Rated Current | Leakage Current (Max.)         | Circuit Diagram | Figure | Temperature Rise (Max.) |   |
|----------------|---------------------------|---------------|--------------------------------|-----------------|--------|-------------------------|---|
| 12-MMF-002-5-F | 120/250VAC                | 2A            | 0.25mA@120VAC/<br>0.5mA@250VAC | 1               | A      | 30°C                    |   |
| 12-MMF-003-5-F |                           | 3A            |                                |                 | A      |                         |   |
| 12-MMF-003-5-A |                           |               |                                |                 | B      |                         |   |
| 12-MMF-006-5-F |                           | 6A            |                                | A               | 2      |                         |   |
| 12-MMF-006-5-G |                           |               |                                | C               |        |                         |   |
| 12-MMF-008-5-B |                           | 8A            |                                | A               |        |                         |   |
| 12-MMF-010-5-F |                           | 10A           |                                | A1              |        |                         |   |
| 12-MMF-010-5-G |                           |               |                                |                 |        |                         | C |
| 12-MMF-010-5-B |                           |               |                                |                 |        |                         | D |
| 12-MMF-012-5-B |                           | 12A           |                                |                 |        |                         |   |
| 12-MMB-015-5-E |                           | 15A           |                                |                 |        |                         |   |
| 12-MMB-020-5-F |                           | 20A           |                                |                 |        |                         |   |
| 12-MMB-030-5-D |                           | 30A           |                                |                 |        |                         |   |
| 12-MMB-050-5-C |                           | 50A           |                                |                 |        |                         |   |

Note: All types are designed to meet the requirement of UL 1283, CSA 22.2, VDE 0565-3  
 Test voltage: 1500VAC one minute, line to ground  
 Insulation resistance: 300 Mohm min. at 500VDC  
 Voltage drop: 1V max.  
 Discharge time: 0.4 sec. max.

# Power Line Filters Dual Stage

## 12-MMF & 12-MMB Series

**Figure B**



**Figure C**



**Figure E**



**Figure F**



**Figure A**



**Figure A1**



**Figure D**

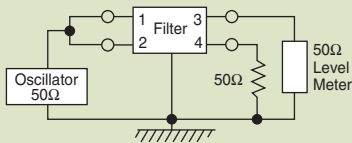

**Figure G**



Dimensions in inches (mm)

### Common Mode



#### 12-MMF-002;-003;-006;-008



#### 12-MMF-010;-012;-015;-020;-030;-050



### Normal Mode

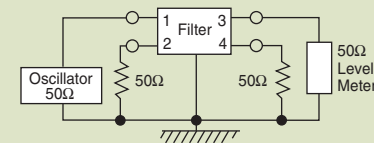

#### 12-MMF-002;-003;-006;-008



#### 12-MMF-010;-012;-015;-020;-030;-050

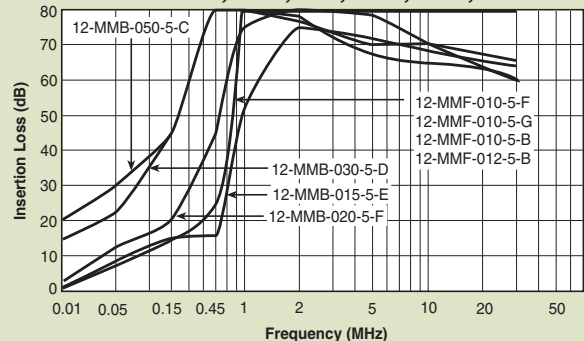

# Power Line Filters Dual Stage



## 12-MMF & 12-MMB Series

### Features

- Suitable for products that must conform to FCC regulations
- Excellent attenuation for high voltage impulse
- Metal case provides effective EMI shielding
- Two stages for excellent filtering characteristics
- Structure provides effective shielding for noise generated both externally and internally
- Operating temperature: -40°C to +85°C
- High performance

### Applications

- Digital equipment
- Personal computers and peripherals
- Measuring instruments and medical equipment
- Telecommunications equipment
- Equipment requiring very high noise attenuation

### Circuit Diagram

Circuit 1



Circuit 2



### Specifications

| Model           | Rated Voltage (@ 50/60Hz) | Rated Current | Leakage Current (Max.) | Circuit Diagram | Figure | Temperature Rise (Max.) |
|-----------------|---------------------------|---------------|------------------------|-----------------|--------|-------------------------|
| 12-MMF-003-11-F | 120/250VAC                | 3A            | 1.5mA                  | 1               | A      | 30°C                    |
| 12-MMF-006-11-F |                           | 6A            |                        |                 | C      |                         |
| 12-MMF-010-11-F |                           | 10A           |                        |                 | B      |                         |
| 12-MMB-015-11-G |                           | 15A           |                        | 2               | D      |                         |
| 12-MMB-020-11-D |                           | 20A           |                        |                 | E      |                         |
| 12-MMB-030-11-D |                           | 30A           |                        |                 | F      |                         |
| 12-MMB-040-11-B |                           | 40A           |                        | 1               |        |                         |
| 12-MMB-040-11-E |                           |               |                        |                 |        |                         |
| 12-MMB-050-11-H |                           | 50A           |                        |                 |        |                         |

Note: All types are designed to meet the requirement of UL 1283, CSA 22.2. VDE 0565-3  
 Test voltage: 1500VAC one minute, line to ground  
 Insulation resistance: 300 Mohm min. at 500VDC  
 Leakage current: 0.7 mA max.  
 Voltage drop: 1V max.  
 Discharge time: 0.4 sec. max.  
 Weight: 6.0 ounces (170 grams)

# Power Line Filters Dual Stage

## 12-MMF & 12-MMB Series

**Figure A**



**Figure B**

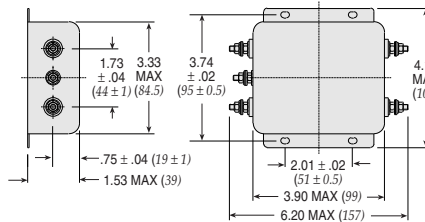

**Figure C**

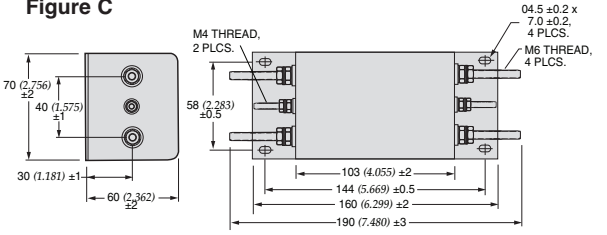

**Figure D**



**Figure E**

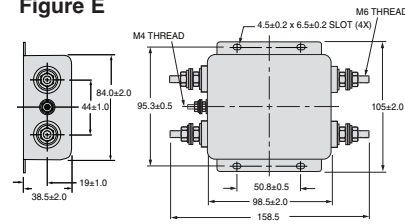

**Figure F**

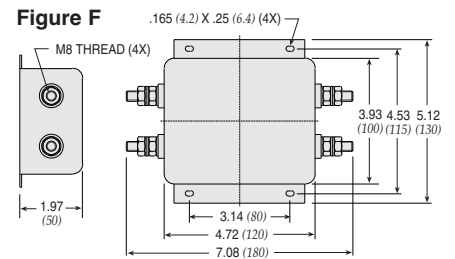

Dimensions in inches (mm)

### Common Mode



#### 12-MMF/MMB-003;-006;-010;-012;-015



#### 12-MMB-020;-030;-040;-050



### Normal Mode



#### 12-MMF/MMB-003;-006;-010;-012;-015



#### 12-MMB-020;-030;-040;-050



# Power Line Filters Dual Stage



## 12-MMF & 12-MMB Series

### Features

- Suitable for products that must conform to FCC regulations
- Excellent attenuation for high voltage impulse
- Metal case provides effective EMI shielding
- Two stages for excellent filtering characteristics
- Epoxy molded for reliability
- Structure provides effective shielding for noise generated both externally and internally
- Operating temperature: -25°C to +85°C

### Applications

- Digital equipment
- Personal computers and peripherals
- Measuring instruments and medical equipment
- Telecommunications equipment
- Equipment requiring very high noise attenuation

### Circuit Diagram

Circuit 1



Circuit 2



Circuit 3

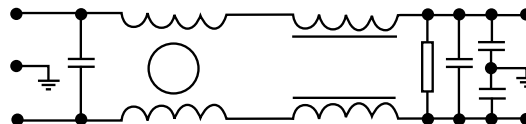

### Specifications

| Model          | Rated Voltage (@ 50/60Hz) | Rated Current | Leakage Current (Max.) | Circuit Diagram | Figure | Temperature Rise (Max.) |
|----------------|---------------------------|---------------|------------------------|-----------------|--------|-------------------------|
| 12-MMF-001-5-F | 120/250VAC                | 1A            | 0.5mA                  | 3               | A      | 30°C                    |
| 12-MMF-003-5-G |                           | 3A            |                        |                 | 5uA    |                         |
| 12-MMF-003-2-G |                           |               | 6A                     | 0.5mA           |        |                         |
| 12-MMF-006-5-G |                           | 10A           | D                      |                 |        |                         |
| 12-MMB-010-5-D |                           | 15A           |                        |                 |        |                         |
| 12-MMB-015-5-E |                           | 20A           |                        |                 |        |                         |
| 12-MMB-020-5-E |                           | 30A           |                        |                 |        |                         |
| 12-MMB-030-5-E |                           |               |                        |                 |        |                         |

Note: All types are designed to meet the requirement of UL 1283, CSA 22.2. VDE 0565-3  
 Test voltage: 1500VAC one minute, line to ground  
 Insulation resistance: 300 Mohm min. at 500VDC  
 Leakage current: 0.7 mA max.  
 Voltage drop: 1V max.  
 Discharge time: 0.4 sec. max.  
 Weight: 6.0 ounces (170 grams)

# Power Line Filters Dual Stage

## 12-MMF & 12-MMB Series

**Figure A**



**Figure B**



**Figure C**



**Figure D**



Dimensions in inches (mm)

### Common Mode



#### 12-MMF-001;-003;-006



#### 12-MMB-010;-015;-020;-030



### Normal Mode



#### 12-MMF-001;-003;-006



#### 12-MMB-010;-015;-020;-030

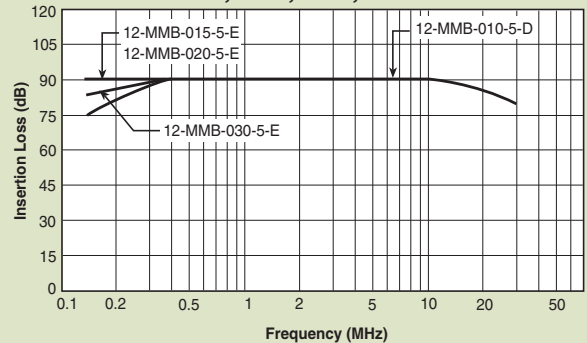

Компания «Life Electronics» занимается поставками электронных компонентов импортного и отечественного производства от производителей и со складов крупных дистрибьюторов Европы, Америки и Азии.

С конца 2013 года компания активно расширяет линейку поставок компонентов по направлению коаксиальный кабель, кварцевые генераторы и конденсаторы (керамические, пленочные, электролитические), за счёт заключения дистрибьюторских договоров

Мы предлагаем:

- Конкурентоспособные цены и скидки постоянным клиентам.
- Специальные условия для постоянных клиентов.
- Подбор аналогов.
- Поставку компонентов в любых объемах, удовлетворяющих вашим потребностям.
- Приемлемые сроки поставки, возможна ускоренная поставка.
- Доставку товара в любую точку России и стран СНГ.
- Комплексную поставку.
- Работу по проектам и поставку образцов.
- Формирование склада под заказчика.
- Сертификаты соответствия на поставляемую продукцию (по желанию клиента).
- Тестирование поставляемой продукции.
- Поставку компонентов, требующих военную и космическую приемку.
- Входной контроль качества.
- Наличие сертификата ISO.

В составе нашей компании организован Конструкторский отдел, призванный помогать разработчикам, и инженерам.

Конструкторский отдел помогает осуществить:

- Регистрацию проекта у производителя компонентов.
- Техническую поддержку проекта.
- Защиту от снятия компонента с производства.
- Оценку стоимости проекта по компонентам.
- Изготовление тестовой платы монтаж и пусконаладочные работы.



Тел: +7 (812) 336 43 04 (многоканальный)

Email: [org@lifeelectronics.ru](mailto:org@lifeelectronics.ru)