

Model 787

ProcessMeter™

Calibration Manual

PN 641891

May 1998 Rev. 1, 9/00

© 1998, 2000 Fluke Corporation, All rights reserved. Printed in USA
All product names are trademarks of their respective companies.

Table of Contents

Title	Page
Introduction	1
Read First -- Safety Information	2
787 Calibration Module	2
Warnings and Cautions	2
International Symbols	4
Required Equipment	4
Specifications	5
DC Volts	5
DC Millivolts	6
AC Volts	6
AC Current	6
DC Current	6
Ohms	7
Frequency Counter Accuracy	7
Frequency Counter Sensitivity	7
Diode Test and Continuity Test	7
DC Current Output	8
General Specifications	8
Basic Maintenance	9
Cleaning the 787 ProcessMeter and the 787 Calibration Module	9
Replacing the Battery	9
Checking and Replacing Fuses	10
Verification Tests	11
Computer-Automated Verification Test Procedures	12
Preparing to Perform the Verifications Tests	12
Loop Power Test	14
Current Sourcing Test	15
Current Measurement Test	16
Checking the Diode Test Function	17
Checking the Continuity Test Function	19
Resistance Measurement Test	20
DC Millivolts Measurement Test	22
DC Volts Measurement Tests	23
AC Volts Measurement Test	23
Frequency Measurement Test	25
Calibration	26
Preparing for Calibration	26
Installing the 787 Calibration Module	27
Using the MET/CAL Calibration Software	30
Replaceable Parts	30

Model 787

Calibration Manual

List of Tables

Table	Title	Page
1.	International Symbols.....	4
2.	Required Equipment and Software.....	5
3.	Current Sourcing Test.....	15
4.	DC mA Test.....	16
5.	DC Amp Test.....	16
6.	AC Amp Test.....	16
7.	Resistance Measurement Test Using a 5500A or 5520A Calibrator.....	21
8.	DC mV Test.....	22
9.	DC Volts Test.....	23
10.	AC Volts Test.....	24
11.	Frequency Measurement Test.....	25
12.	Replacement Parts.....	30

List of Figures

Figure	Title	Page
1.	Replacing the Battery	9
2.	Replacing a Fuse.....	11
3.	Verifying Loop Power	14
4.	Current Sourcing Connections Using the HP 3458A	15
5.	Current Measurement Test Connections	17
6.	Diode Test Connections.....	18
7.	Continuity Test Connections	19
8.	Resistance Measurement Test Connections	20
9.	DC mV Measurement Test Connections	22
10.	AC/DC Voltage Measurement Test Connections.....	24
11.	Frequency Measurement Test Connections.....	25
12.	Calibration Connections for the 787 ProcessMeter.....	28
13.	Connecting the 787 Calibration Module to the UUT	29
14.	Replacement Parts	31

Calibration Manual

Introduction

⚠ Warning

The information provided in this manual is for the use of qualified personnel only. Do not perform the verification tests or calibration procedures described in this manual unless you are qualified to do so.

Caution

The 787 ProcessMeter™ contains parts that can be damaged by static discharge. No procedure in this document requires the case to be opened. If you do so, follow the standard practices for handling static sensitive devices.

The *Calibration Manual* for the 787 ProcessMeter (hereafter, also referred to as “the ProcessMeter” or “the UUT”) provides the following information:

- Precautions and Safety information
- Specifications
- Basic maintenance (cleaning, replacing the battery and fuses)
- Verification test procedures
- Calibration and calibration adjustment procedures
- Accessories and replaceable parts

For complete operating instructions, refer to the *787 ProcessMeter Users Manual* (on the CD-ROM provided).

To contact Fluke, call:

USA : 1-888-99-FLUKE (1-888-993-5853)
Europe: +31 402-678-200
Singapore: +65-738-5655

Canada: 1-800-36-FLUKE (1-800-363-5853)
Japan: +81-3-3434-0181
Anywhere in the world: +1-425-446-5500

Address correspondence to:

Fluke Corporation
P.O. Box 9090,
Everett, WA 98206-9090
USA

Fluke Europe B.V.
P.O. Box 1186,
5602 BD Eindhoven
The Netherlands

Or visit us on the World Wide Web: www.fluke.com

Read First -- Safety Information

787 Calibration Module

The calibration procedure for the 787 ProcessMeter requires the use of the 787 Calibration Module (hereafter, also referred to as the “Calibration Module”), which is designed for this purpose.

Note

It is critical that you be aware of the rating differences between the 787 ProcessMeter and the 787 Calibration Module.

- *The 787 ProcessMeter complies with IEC 1010-1, ANSI/ISA S82.01-1994, and CAN/CSA C22.2 No. 1010.1-92, and has received UL and TÜV certification.*

It is rated 1000 V Overvoltage Category III.

- *The 787 Calibration Module complies with IEC 1010-1, ANSI/ISA S82.01-1994, and CAN/CSA C22.2 No. 1010.1-92.*

It is rated 1000 V Overvoltage Category I. The 787 Calibration Module is not rated for the Overvoltage Category III environment.

DO NOT USE the 787 Calibration Module during regular operation of the 787 ProcessMeter.

DO NOT LEAVE the 787 Calibration Module attached to the 787 ProcessMeter during regular operation of the 787 ProcessMeter.

Use the 787 ProcessMeter and the 787 Calibration Module only as described in the 787 ProcessMeter *Users Manual* and the 787 *Calibration Manual*, respectively. Otherwise, the protection designed into the ProcessMeter and Calibration Module may be impaired.

Warnings and Cautions

In this manual, a **Warning** identifies conditions and actions that pose hazard(s) to the user, a **Caution** identifies conditions and actions that may damage the 787 ProcessMeter or the test instruments.

⚠ Warnings

To avoid possible electric shock or personal injury:

- **DO NOT USE** the Calibration Module during regular operation of the ProcessMeter.
- **DO NOT LEAVE** the Calibration Module attached to the ProcessMeter during regular operation of the ProcessMeter.
- **Use only** the battery eliminator supplied with the Calibration Module as an external power supply, see Table 2. A generic battery eliminator might pose a safety hazard.
- **DO NOT use** the ProcessMeter or the Calibration Module if either one looks damaged.
- **Examine the ProcessMeter and Calibration Module before use.** Look for cracks in the case, missing plastic, or damaged insulation around the connectors.

(Continued on next page)

⚠ Warnings (Continued)

- Inspect the test leads for damaged insulation or exposed metal. Check for test lead continuity. Replace damaged test leads as necessary.
- Do not use the ProcessMeter or the Calibration Module if either operates abnormally. Protection may be impaired. When in doubt, have the instruments serviced.
- Do not apply more than the rated voltage, as marked on the ProcessMeter and the Calibration Module, between terminals or between any terminal and earth ground.
- When using probes, keep fingers behind the finger guards on the probes.
- Use caution when working above 30 V ac rms, 42 V ac peak, or 60 V dc. Such voltages pose a shock hazard.
- Connect the common lead (COM) before connecting the live test lead. When disconnecting test leads, disconnect the live test lead first.
- Remove test leads from the ProcessMeter before opening the battery door.
- Do not operate the ProcessMeter or Calibration Module around explosive gas, vapor or dust.
- During normal operation, use only a single properly installed 9 V battery to power the ProcessMeter.
- Make sure the battery door is closed and latched before you operate the ProcessMeter.
- During Calibration, use only specified calibration equipment listed in Table 2. There are no substitutes for the battery eliminator, Calibration Module, and Calibration Software.
- During Calibration, properly connect the Calibration Module to the ProcessMeter.
- When servicing the ProcessMeter or the Calibration Module, use only specified replacement parts.
- Before measuring current, check the ProcessMeter's fuses, see "Testing the Fuses" in the *787 Users Manual*.
- To avoid false readings, which can lead to possible electric shock or personal injury, replace the battery as soon as the low battery indicator (🔋) appears.

Caution













To avoid possible damage to the ProcessMeter or to the test instruments:

- Disconnect the power and discharge all high voltage capacitors before testing resistance, diode, or continuity.
- Use the proper terminals, rotary switch setting, and range for the measurement or sourcing application.

International Symbols

International symbols used on the ProcessMeter and in this calibration manual are explained in Table 1.

Table 1. International Symbols

Symbol	Meaning	Symbol	Meaning
	Alternating current		Earth ground
	Direct current		Fuse
	Alternating or direct current		Conforms to European Union directives
	Refer to the manual. Important information.		Conforms to relevant Canadian Standards Association directives
	Battery		Double insulated
	Meet Underwriter's Laboratories safety requirements		Inspected and licensed by TÜV Product Services
CAT III	Overvoltage (Installation) Category III, Pollution Degree 2 per IEC1010-1 refers to the level of Impulse Withstand Voltage protection provided. Typical locations include: Mains, wall outlets, main distribution levels connected closer to the supply system but less than the primary supply system (CAT IV)		

Required Equipment

Equipment and software required to perform the procedures in this manual are identified in Table 2.

If the recommended equipment model is not available, in some cases other equipment can be substituted as long as it meets the specifications indicated.

Warning

To avoid safety hazards and equipment damage during the calibration procedure, use the specified calibration equipment listed in Table 2. Using unspecified equipment can jeopardize the verification test and pose safety hazards.

Note

Unless otherwise indicated, all connection diagrams for the verification tests in this manual showing a calibrator or digital multimeter use a Fluke 5500A calibrator or HP 3458A.

If you are using a different calibrator or DMM make the connections appropriate for your instrument.

Table 2. Required Equipment and Software

Equipment	Minimum Specifications	Recommended Model
Calibration Source	No Substitute	Fluke Model 5500A, 5520A
Digital Multimeter	No Substitute	HP 3458A, HP 34401A*
Test Leads, low leakage, RG-58/U type	Leakage resistance > than $1.0 \times 10^{13} \Omega$ at 45 °C and 75 % relative humidity	Fluke 5440A-7002 Low Thermal Test Leads
Calibration Module w/Battery Eliminator	⚠ No Substitute. A generic battery eliminator might pose a safety hazard. Includes Cal Module, Battery Eliminator, Calibration Manual, and MET/CAL Calibration Software (provided on floppy disk).	Fluke-787CAL 120 (USA/Canada) Fluke-787CAL 230 (Europe) Fluke-787CAL 240 (UK) Fluke-787CAL 240AN (Australia) Fluke-787CAL 100 (Japan)
Battery Eliminator, Input: 120-240 V AC; Output: 12 V DC/ 300 mA.	No Substitute. Only use a BE860 battery eliminator.	Fluke BE860 120 (in USA/Can) Fluke BE860 230 (Europe) Fluke BE860 240 (UK) Fluke BE860 240AN (Aus)
Null Modem Cable	9-pin to 9-pin	Fluke RS 43
Personal Computer	Windows® 3.1 or later (Refer to MET/CAL® manual set), 16 MB RAM, 80 MB on disk, VGA monitor.	486 (or later) IBM-compatible
Calibration Software	No Substitute	Fluke <i>MET/CAL Calibration Software 6.0 or later</i>
* HP 34401A may only be used in conjunction with Fluke 5520A.		

Specifications

The 787 ProcessMeter's performance and accuracy are specified for one year after calibration, at operating temperatures of +18 °C to +28 °C (64 °F to 82 °F), in relative humidity to 90 %, after the ProcessMeter has been warmed up for 5 minutes.

Note

A "count" is the amount by which the least significant digit can vary.

DC Volts

Range (V dc)	Resolution	Accuracy, \pm (% of Reading + Counts)
4.000	0.001 V	0.1 % + 1
40.00	0.01 V	0.1 % + 1
400.0	0.1 V	0.1 % + 1
1000	1 V	0.1 % + 1
Input impedance: 10 M Ω (nominal), < 100 pF Normal mode rejection ratio: >60 dB at 50 Hz or 60 Hz Common mode rejection ratio: >120 dB at dc, 50 Hz, or 60 Hz Overvoltage protection: 1000 V		

DC Millivolts

Range (mV dc)	Resolution	Accuracy (% of Reading + Counts)
400.0	0.1 mV	0.1 % + 1

Input impedance: 10 MΩ (nominal), < 100 pF
 Normal mode rejection ratio: >60 dB at 50 Hz or 60 Hz
 Common mode rejection ratio: >120 dB at dc, 50 Hz, or 60 Hz
 Overvoltage protection: 1000 V

AC Volts

Range (ac)	Resolution	Accuracy ¹ ± (% of Reading + Counts)		
		50 Hz to 60 Hz	45 Hz to 200 Hz	200 Hz to 500 Hz
400.0 mV	0.1 mV	0.7 % + 4	1.2 % + 4	7.0 % + 4
4.000 V	0.001 V	0.7 % + 2	1.2 % + 4	7.0 % + 4
40.00 V	0.01 V	0.7 % + 2	1.2 % + 4	7.0 % + 4
400.0 V	0.1 V	0.7 % + 2	1.2 % + 4	7.0 % + 4
1000 V	1 V	0.7 % + 2	1.2 % + 4	7.0 % + 4

1. Specifications are valid from 5 % to 100 % of amplitude range.
 AC conversion: true rms
 Maximum crest factor: 3
 For non-sinusoidal waveforms, add ±(2 % reading + 2 % f.s.) typical.
 Input impedance: 10 MΩ (nominal), < 100 pF, ac-coupled.
 Common mode rejection ratio: >60 dB at dc, 50 Hz, or 60 Hz.

AC Current

Range 45 Hz to 2 kHz	Resolution	Accuracy ¹ ± (% of Reading + Counts)	Typical Burden Voltage
1.000 A	0.001 A	1% + 2	1.5 V/A

1. Specifications are valid from 5 % to 100 % of amplitude range.
 AC conversion: true rms
 Maximum crest factor: 3
 For non-sinusoidal waveforms, add ± (2 % reading + 2 % f.s.) typical.
 Input impedance: 10 MΩ (nominal), < 100 pF, ac-coupled.
 Common mode rejection ratio: >60 dB at dc, 50 Hz, or 60 Hz.

DC Current

Range	Resolution	Accuracy ¹ ± (% of Reading + Counts)	Typical Burden Voltage
30.000 mA	0.001 mA	0.05 % + 2	14 mV/mA
1.000 A ²	0.001 A	0.2 % + 2	1.5 V/A

1 Specifications are valid from 5 % to 100 % of amplitude range.
 AC conversion: true rms
 Maximum crest factor: 3
 For non-sinusoidal waveforms, add ± (2 % reading + 2 % f.s.) typical.
 Input impedance: 10 MΩ (nominal), < 100 pF, ac-coupled.
 Common mode rejection ratio: >60 dB at dc, 50 Hz, or 60 Hz.

2 400 mA continuous, 1A 30 seconds maximum. Overload protection: 440 mA, 1000V fast-blow fuse.

Ohms

Range	Resolution	Measurement Current	Accuracy \pm (% of Reading + Counts)
400.0 Ω	0.1 Ω	220 μ A	0.2 % + 2
4.000 k Ω	0.001 k Ω	59 μ A	0.2 % + 1
40.00 k Ω	0.01 k Ω	5.9 μ A	0.2 % + 1
400.0 k Ω	0.1 k Ω	590 nA	0.2 % + 1
4.000 M Ω	0.001 M Ω	220 nA	0.35 % + 3
40.00 M Ω	0.01 M Ω	22 nA	2.5 % + 3

Overload protection: 1000 V
Open circuit voltage: <3.9 V

Frequency Counter Accuracy

Range	Resolution	Accuracy \pm (% of Reading + Counts)
199.99 Hz	0.01 Hz	0.005 % + 1
1999.9 Hz	0.1 Hz	0.005 % + 1
19.999 kHz	0.001 kHz	0.005 % + 1

Display updates 3 times/second at >10 Hz

Frequency Counter Sensitivity

Input Range	Minimum Sensitivity (rms Sinewave) 0.5 Hz to 20 kHz*
1 V	0.1 V
4 V	1 V
40 V	3 V
400 V	30 V
1000 V	300 V

* Usable 0.5 Hz to 20 kHz with reduced sensitivity

Diode Test and Continuity Test

Diode test indication	Display voltage drop: 0.2 mA nominal test current at 0.6 V. 2.4 V full scale, accuracy \pm (2 % + 1 count)
Continuity test indication	continuous audible tone for test resistance <100 Ω
Open circuit voltage	<3.9 V
Short circuit current	1.2 mA typical
Overload protection	1000 V rms

DC Current Output

Source mode	Span: 0 mA or 4 mA to 20 mA, with overrange to 24 mA Accuracy: 0.05 % of span Compliance voltage: 12 V with battery voltage >8.5 V
Simulate Mode	Span: 0 mA or 4 mA to 20 mA, with overrange to 24 mA Accuracy: 0.05 % of span Loop voltage: 24 V nominal, 30 V maximum, 15 V minimum Compliance voltage: 21 V for 24 V supply Burden voltage: <3 V

General Specifications

Maximum voltage applied between any jack and earth ground	1000 V
Storage temperature	-40 °C to 60 °C
Operating temperature	-20 °C to 55 °C
Operating altitude	2000 meters maximum
Temperature coefficient	0.05 x specified accuracy/ °C for temperatures <18 °C or >28 °C
Accuracy adders for use in RF Fields	In an RF field of 3V/m, change the accuracy specifications as follows: For DC Millivolts Measurement, add 0.03% of range For AC Volts Measurement, add 0.37% of range For DC Current Measurement, 30.000 mA range, add 0.14% of range For DC Current Output, add 0.02% of span Accuracy for all meter functions is not specified in RF fields > 3V/m.
Relative humidity	95 % up to 30 °C 75 % up to 40 °C 45 % up to 50 °C 35 % up to 55 °C
Water and dust protection	Complies with IEC529 IP52 (normal operating vacuum used for dust test)
Vibration	Random 2 g, 5 to 500 Hz
Shock	1 meter drop test
Safety	Complies with IEC1010-1, ANSI/ISA S82.01-1994, CAN/CSA C22.2 No. 1010.1-92 Overvoltage Category III.
Certifications	CSA, UL, TÜV.
Power requirements	Single 9 V battery (ANSI/NEDA 1604A or IEC 6LR61)
Size	32 mm H x 87 mm W x 187 mm L (1.25 in H x 3.41 in W x 7.35 in L)
Size with holster and Flex-Stand	52 mm H x 98 mm W x 201 mm L (2.06 in H x 3.86 in W x 7.93 in L)
Weight	369 g (13 oz)
Weight with holster and Flex-Stand	638 g (22.5 oz)

Basic Maintenance

Cleaning the 787 ProcessMeter and the 787 Calibration Module

⚠ Warning

To avoid electrical shock or damage, never allow water inside the case of the ProcessMeter or the 787 Calibration Module.

If the ProcessMeter or the 787 Calibration Module requires cleaning, wipe it down with a cloth that is lightly dampened with water or a mild detergent.

Do not use aromatic hydrocarbons, chlorinated solvents, or methanol-based fluids when wiping down the ProcessMeter or the 787 Calibration Module. To avoid damaging the case, never apply solvents to the case of the ProcessMeter or the 787 Calibration Module.

Replacing the Battery

⚠ Warning

To avoid electrical shock, remove test leads from the ProcessMeter before opening the battery door. Close and latch the battery door before using the ProcessMeter.

To avoid false readings, which can lead to possible electric shock or personal injury, replace the battery as soon as the battery low indicator (🔋) appears.

The ProcessMeter is powered by a 9 V alkaline battery (ANSI/NEDA 1604A or IEC 6LR61). To replace the battery, refer to Figure 1 and do the following:

1. Turn the rotary switch to **OFF**, remove the test leads from the terminals, and hold the ProcessMeter face down.
2. Using a flat-blade screwdriver, turn the battery door screws 1/4-turn counterclockwise and remove the battery door by.
3. Remove the battery and replace it with a new one.
4. Replace the battery door and secure it by turning the screws 1/4-turn clockwise.

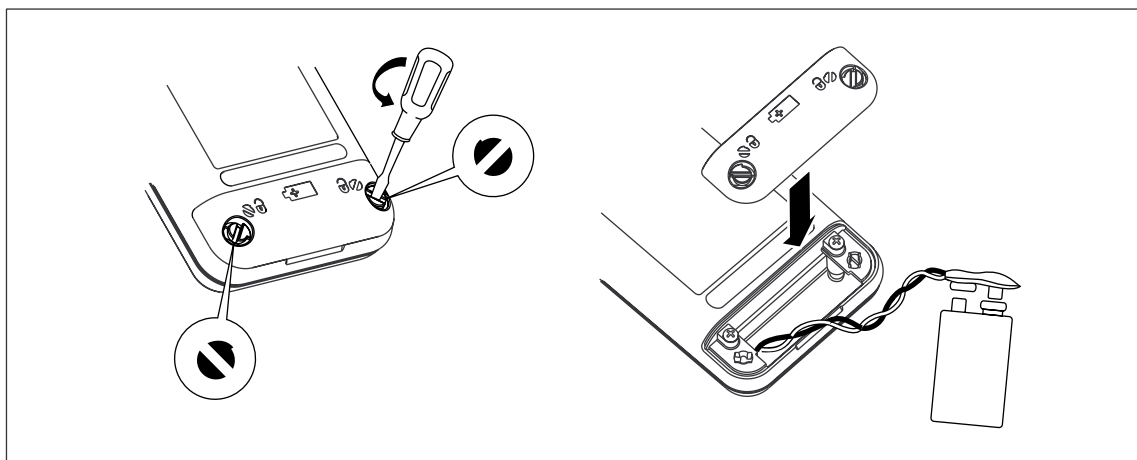

Figure 1. Replacing the Battery

LT013F.EPS

Checking and Replacing Fuses

⚠ Warning

To avoid electric shock or personal injury, remove the test leads and any input signals before replacing a fuse. Make sure that the battery door and case are closed and secured before operating the ProcessMeter.

To avoid injury or damage to the ProcessMeter, use **ONLY** specified replacement fuses with the amperage, voltage, interrupt and speed ratings shown in Table 13.

Both current input terminals are fused with a separate 440 mA fuse.

To determine if a fuse is blown:

1. Turn the rotary switch to **mA A** .
2. Plug the black test lead into **COM**, and the red test lead into \approx A.
3. Using an ohmmeter, check the resistance between the ProcessMeter test leads.

If the resistance is about 1 Ω , the fuse is good. An open means the fuse is blown.

4. Move red test lead to \approx **mA**.
5. Using an ohmmeter, check the resistance between the ProcessMeter test leads.

If the resistance is about 14 Ω , the fuse is good. An open means the fuse is blown.

To replace a fuse, refer to Figure 2 and do the following:

1. Turn the rotary switch to **OFF**, remove the test leads from the terminals, and hold the ProcessMeter face down.
2. Remove the battery door by using a flat-blade screwdriver to turn the battery door screws 1/4-turn counterclockwise.
3. Remove the three Phillips-head screws from the case bottom and turn the case over.
4. Gently lift the input terminal-end of the case top to separate the two halves of the case.
5. Remove the fuse by gently prying one end loose, then sliding the fuse out of its bracket.
6. Replace the fuse *only* with a 440 mA 1000 V fast-blow fuse. (Fluke PN 943121.)

Both fuses are the same type.

7. Verify that the rotary switch and the circuit board switch are in the **OFF** position.
8. Place the case top on the case bottom, ensuring that the gasket is properly seated and the case halves snap together above the LCD end. (See Figure 2.)
9. Reinsert the three case bottom screws and the battery door.

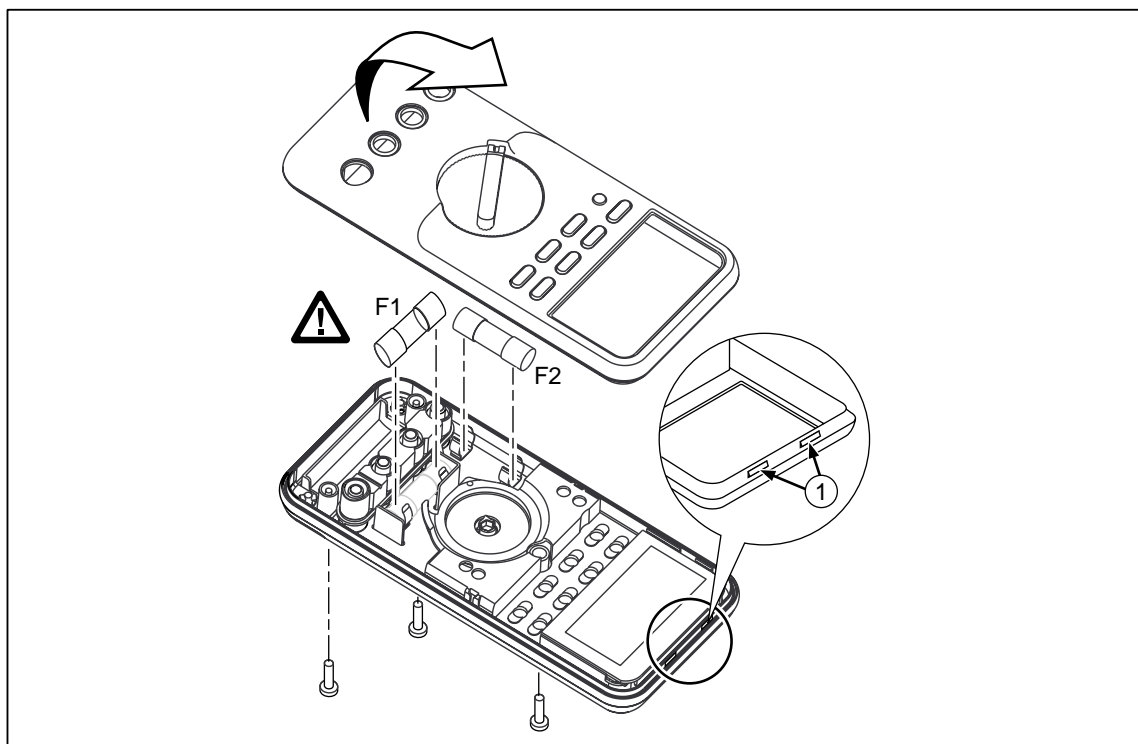

LT014F.EPS

Figure 2. Replacing a Fuse

Verification Tests

⚠ Warning

Some of the verification tests involve the use of high voltages and should be performed by qualified personnel only.

To avoid electrical shock, always place the calibrator in the Standby (STBY) mode between tests and before handling the test connections or test cables.

Verification tests confirm the complete operability of the 787 ProcessMeter and check the accuracy of each ProcessMeter function against the ProcessMeter's specifications. *If the ProcessMeter fails any verification test, it needs calibration adjustment or repair.*

The ProcessMeter's performance and accuracy are specified for one year after calibration at operating temperatures of +18 °C to +28 °C (64 °F to 82 °F), in relative humidity to 90 %. The specifications assume the ProcessMeter has been warmed up for 5 minutes before use.

To perform the verification tests, it is not necessary to open the case; no adjustments are necessary. Merely make the required connections, source the designated values, and determine if the reading on the ProcessMeter or the multimeter falls within the acceptable range indicated.

These verification test procedures assume that the person performing the tests has read the *787 Users Manual*, knows how to select functions and ranges on the ProcessMeter, and knows how to operate the required equipment.

Note

Verification tests for the 787 ProcessMeter can be performed manually, or they can be computer-automated (using Fluke's MET/CAL[®] Calibration Software). This document provides the procedures necessary to perform the verification test manually.

Computer-Automated Verification Test Procedures

Computer-automated verification test procedures for the 787 ProcessMeter are available.

These procedures require Fluke's MET/CAL Calibration Software version 6.0 or later, a 787 Calibration Module, a Fluke 5500A or 5520A Calibrator, and either an HP 34401A multimeter or an HP 3458A multimeter. Note that the HP 34401A may only be used in conjunction with the 5520A Calibrator.

The procedures are:

- **Fluke 787:** (1 year) CAL VER /5500, 3458
- **Fluke 787:** (1 year) CAL VER /5520, 34401
- **Fluke 787:** (1 year) CAL VER /5520, 3458
- **Fluke 787:** (1 year) CAL VER RS-232 /5500, 3458
- **Fluke 787:** (1 year) CAL VER RS-232 /5520, 34401
- **Fluke 787:** (1 year) CAL VER RS-232 /5520, 3458
- **Fluke 787:** CAL ADJ RS-232 /5500, 3458
- **Fluke 787:** CAL ADJ RS-232 /5520, 3458

Refer to the MET/CAL manual set for more information.

Preparing to Perform the Verifications Tests

⚠Warning

To avoid possible electric shock or personal injury:

- **DO NOT use the ProcessMeter or the 787 Calibration Module if either looks damaged.**
- **Before proceeding with the verification tests, inspect the ProcessMeter and the Calibration Module for damage, especially around the input terminals.**
- **Look for cracks, missing plastic, or damaged insulation. If damage is detected, do not continue; contact Fluke to arrange to have the ProcessMeter or Calibration Module serviced.**
- **Make sure that the battery door on the ProcessMeter is closed and latched before using the ProcessMeter.**
- **Inspect the test leads and test connections for damaged insulation or exposed metal.**
- **Check the test leads for continuity. Replace damaged test leads as necessary.**

- **Do not use the ProcessMeter or the Calibration Module if either appears to operate abnormally. Protection designed into the ProcessMeter and Calibration Module might be impaired. If in doubt have the ProcessMeter or Calibration Module serviced.**
- **To avoid electrical shock, always place the calibrator in the Standby (STBY) mode between tests and before handling the test connections or test cables.**
- **Some of the verification tests involve the use of high voltages and should be performed by qualified personnel only.**

Note

These verification tests assume that the person performing them knows how to use the 787 ProcessMeter and the required equipment.

Do not attempt to perform these tests unless you are qualified to do so.

Throughout the verification tests, “UUT” (unit under test) refers to the 787 ProcessMeter; the word “multimeter” is reserved for the digital multimeter identified in the required equipment listed in Table 2.

Unless otherwise indicated, all connection diagrams for the verification tests in this manual showing a calibrator or digital multimeter use a Fluke 5500A calibrator or HP 3458A.

If you are using a different calibrator or DMM make the connections appropriate for your instrument.

To prepare the UUT for the verification tests, do the following:

1. Make sure that you have the required equipment available. (See Table 2.)
2. Make sure that both fuses in the UUT are intact. See “Checking and Replacing Fuses” earlier in this manual.
3. Make sure the UUT has a fresh battery. See “Replacing the Battery” earlier in this manual.
4. Warm up the calibrator and multimeter as required by their specifications.
5. Remove all input cables from the front of the UUT.
6. Make sure that the UUT is in a stable ambient temperature between 18 °C and 28 °C (64.4 °F and 82.4 °F) and that it has been warmed up for 5 minutes.

⚠ Warning

To avoid possible electrical shock or personal injury:

- **Some of the following tests involve the use of high voltages and should be performed by qualified personnel only.**
- **To avoid electrical shock always place the calibrator in the Standby (STBY) mode between tests and before handling the test connections.**

Loop Power Test

1. Make a short circuit connection between the **SOURCE +** ($\approx A$) and **-** ($\approx mA$) terminals on the UUT.
2. Connect the voltage input terminals of the multimeter to the **SOURCE +** and **COM** terminals on the UUT as shown in Figure 3.
3. Put the multimeter in the dc volts (\overline{V}) autorange function.
4. Put the UUT rotary switch in the **OUTPUT $m\overline{A}$** position.
5. Use the **% STEP** key to apply 20 mA from the UUT.

The multimeter display should read at least 12 V.

If the voltage displayed is less than 12 V, either the battery in the UUT is weak or the current source power supply in the UUT is faulty.

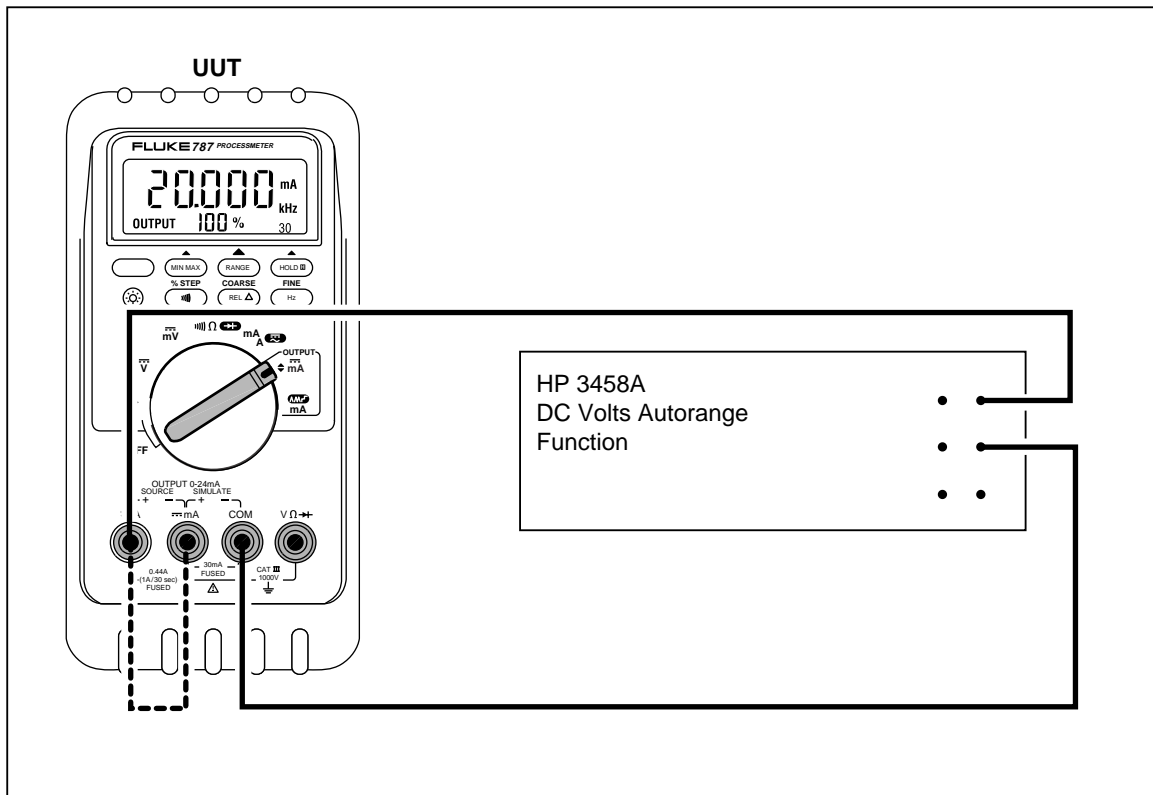

Figure 3. Verifying Loop Power

LT006F.EPS

Current Sourcing Test

1. Put the calibrator in Standby (**STBY**) mode.
2. Connect the **SOURCE +** (\approx **A**) and **-** (\approx **mA**) terminals on the UUT to the current terminals on the multimeter as shown in Figure 4.
3. Put the multimeter in the dc mA function and manually select 100 mA range. (Do not allow the multimeter to autorange.)
4. Put the UUT rotary switch in the **OUTPUT m \bar{A}** position.
5. Use the **% STEP** and **COARSE** keys on the UUT to apply the values shown in Table 3 and compare the readings on the multimeter to the acceptable readings shown.

Table 3. Current Sourcing Test

787 Range	787 Output Current	Minimum Acceptable Multimeter Reading	Maximum Acceptable Multimeter Reading
No Range Switching	4 mA	3.99 mA	4.01 mA
No Range Switching	12 mA	11.99 mA	12.01 mA
No Range Switching	20 mA	19.99 mA	20.01 mA

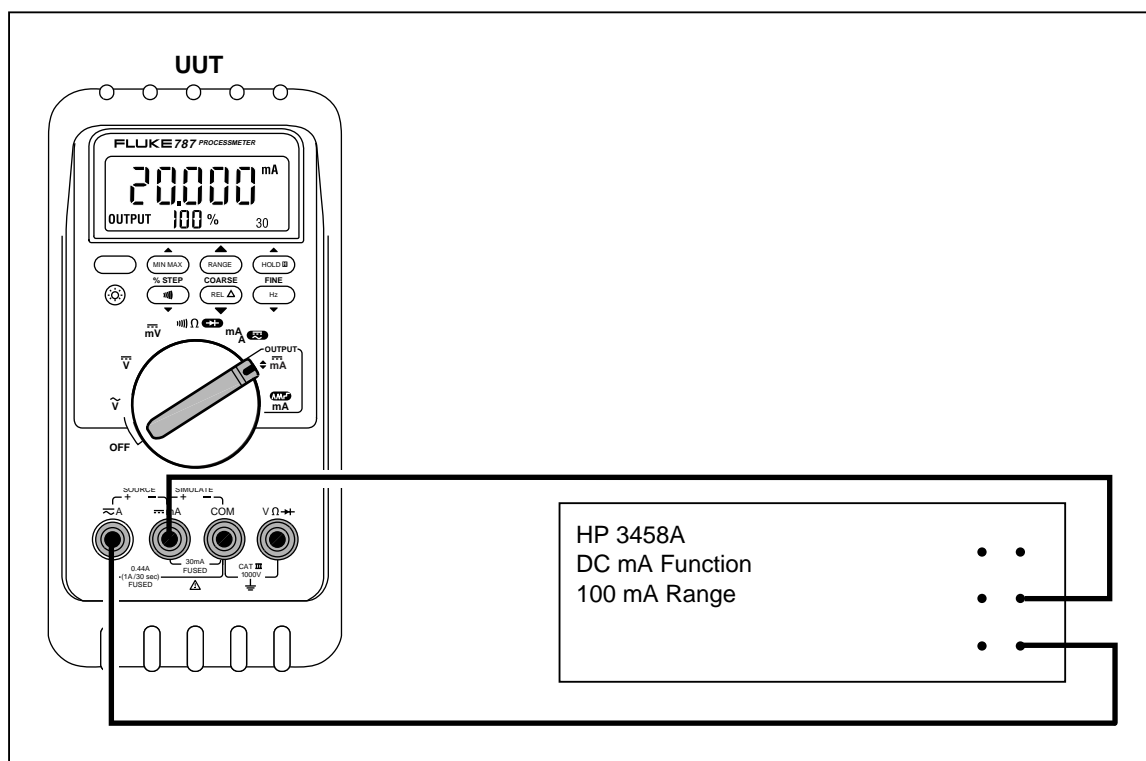

Figure 4. Current Sourcing Connections Using the HP 3458A

LT001F.EPS

Current Measurement Test

1. Put the calibrator in Standby (**STBY**) mode.
2. Put the UUT rotary switch in the **mA A**  position .
3. Connect the calibrator to the **COM** and **mA** terminals on the UUT as shown in Figure 5.
4. Apply the values from the calibrator shown in Table 4 and compare the readings on the UUT to the acceptable readings shown.
5. Connect the calibrator to the **COM** and **A** terminals on the UUT.
6. Apply the values from the calibrator shown in Table 5 and compare the readings on the UUT to the acceptable readings shown.
7. Press the BLUE button on the UUT to toggle to ac amps.
8. Apply the values from the calibrator shown in Table 6 and compare the readings on the UUT to the acceptable readings shown.

Table 4. DC mA Test

787 Range	Calibrator DC Current	Minimum Acceptable Reading	Maximum Acceptable Reading
No Range Switching	4 mA	3.996 mA	4.004 mA
No Range Switching	12 mA	11.992 mA	12.008 mA
No Range Switching	20 mA	19.988 mA	20.012 mA

Table 5. DC Amp Test

787 Range	Calibrator DC Current	Minimum Acceptable Reading	Maximum Acceptable Reading
No Range Switching	0.1 A	0.098 A	0.102 A
No Range Switching	0.4 A	0.397 A	0.403 A

Table 6. AC Amp Test

787 Range	Calibrator AC Current and Frequency	Minimum Acceptable Reading	Maximum Acceptable Reading
No Range Switching	0.1 A @ 60 Hz	0.097 A	0.103 A
No Range Switching	0.4 A @ 60 Hz	0.394 A	0.406 A

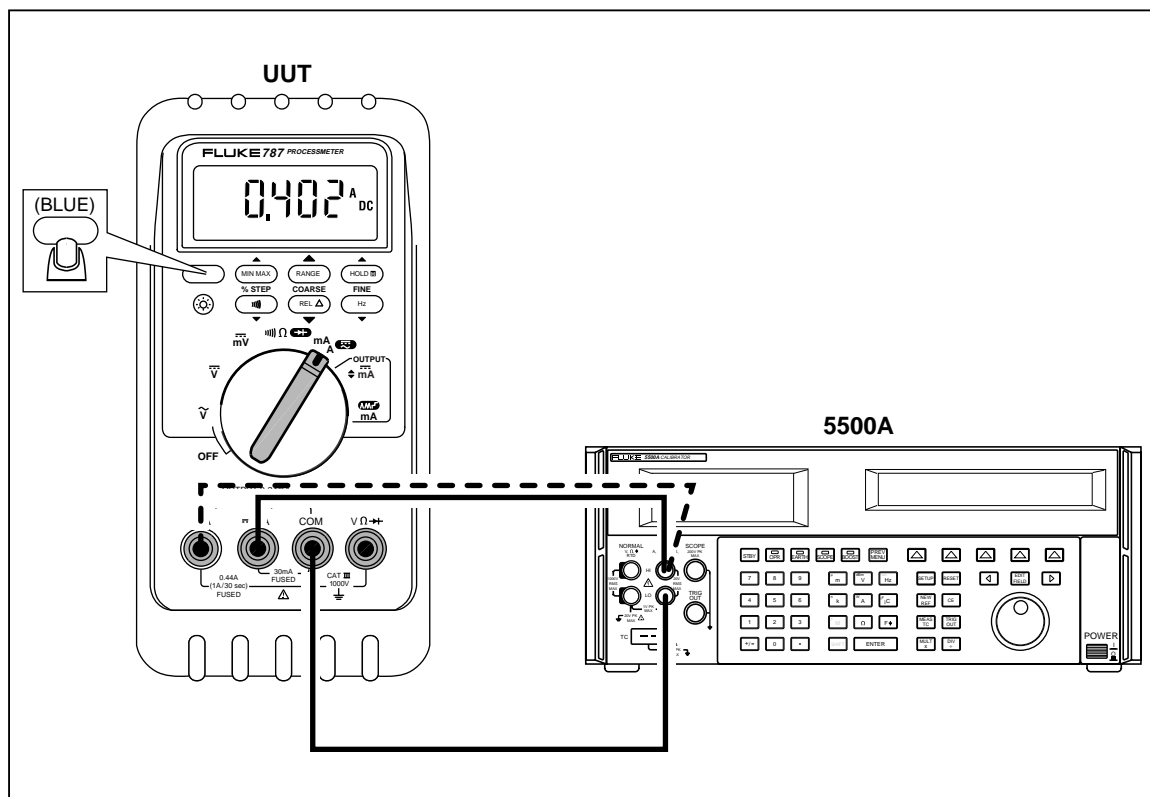

Figure 5. Current Measurement Test Connections

LT003F.EPS

Checking the Diode Test Function

1. Put the calibrator in Standby (**STBY**) mode.
2. Put the UUT rotary switch in the $\Omega \rightarrow$ position.
3. Press the BLUE button to select diode test (\rightarrow).
4. Connect the calibrator to the **COM** and **V $\Omega \rightarrow$** terminals on the UUT as shown in Figure 6.
5. Apply 2.0 V dc from the calibrator.
6. The UUT should read between 1.959 V and 2.041 V.
7. Put the calibrator in Standby (**STBY**) mode; then disconnect the calibrator from the UUT.
8. Put the multimeter in the dc mA (autorange) function.
9. Connect the current terminals of the multimeter to the **COM** and **V $\Omega \rightarrow$** terminals on the UUT.
10. The multimeter should read close to 0.2 mA. (There is no tolerance specification for this current. This test just makes sure that the diode test current source is operating.)

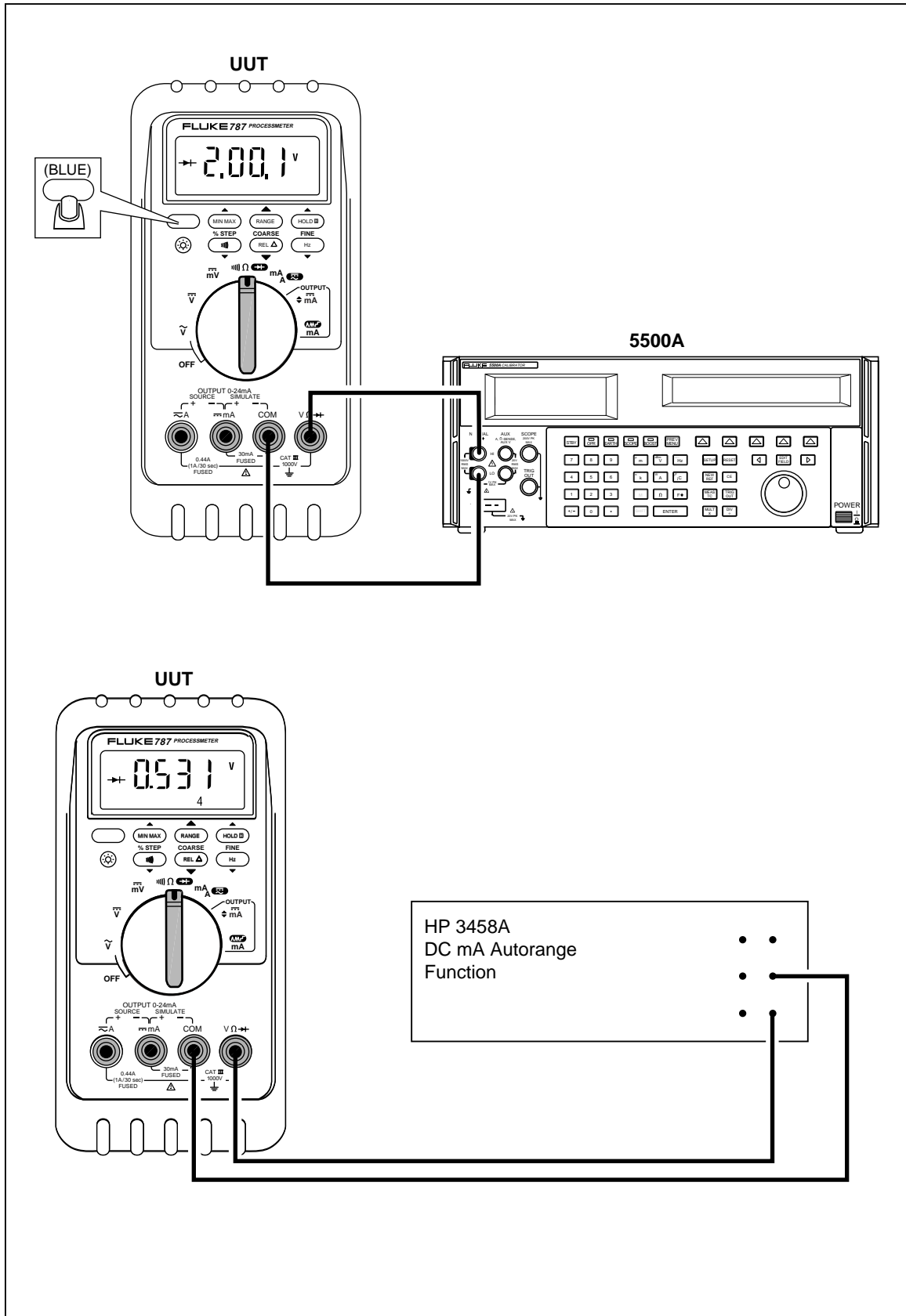



Figure 6. Diode Test Connections

LT007F.EPS

Checking the Continuity Test Function

1. Put the calibrator in Standby (**STBY**) mode, and put the UUT rotary switch in the Ω position.
2. Connect the calibrator to the **COM** and **V Ω →** terminals on the UUT as shown in Figure 7.
3. Press  (continuity beeper) on the UUT to select the continuity test.
4. Using the calibrator, apply a resistance output of $230 \pm 20 \Omega$.

The beeper should stay off.

5. Using the calibrator, apply a resistance output of $120 \pm 20 \Omega$.

The beeper should turn on.

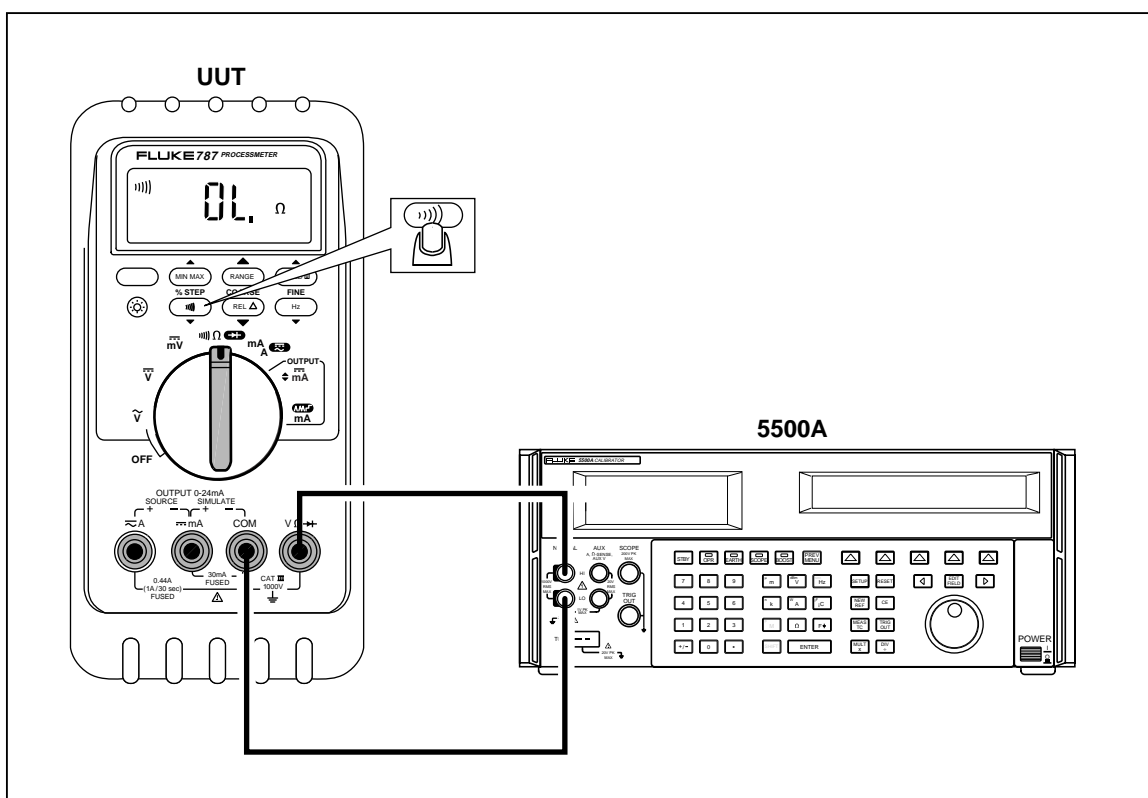

LT0008F.EPS

Figure 7. Continuity Test Connections

Resistance Measurement Test

1. Put the calibrator in Standby (**STBY**) mode.
2. Put the UUT rotary switch in the Ω position.
3. Connect the Output and Sense leads of the calibrator to the UUT as shown by the solid and dotted lines in Figure 8.
4. Apply the calibrator resistance values in Table 7 in the 787 400 Ω to 40 k Ω range. Compare the readings on the UUT to the acceptable readings shown.
5. Change the connections to the UUT. Using the Fluke 5440A-7002 low thermal leads, connect the calibrator to the UUT as shown by the solid lines in Figure 8.
6. Apply the rest of the calibrator resistance values in Table 7 (400 k Ω range and above). Compare the readings on the UUT to the acceptable readings shown.

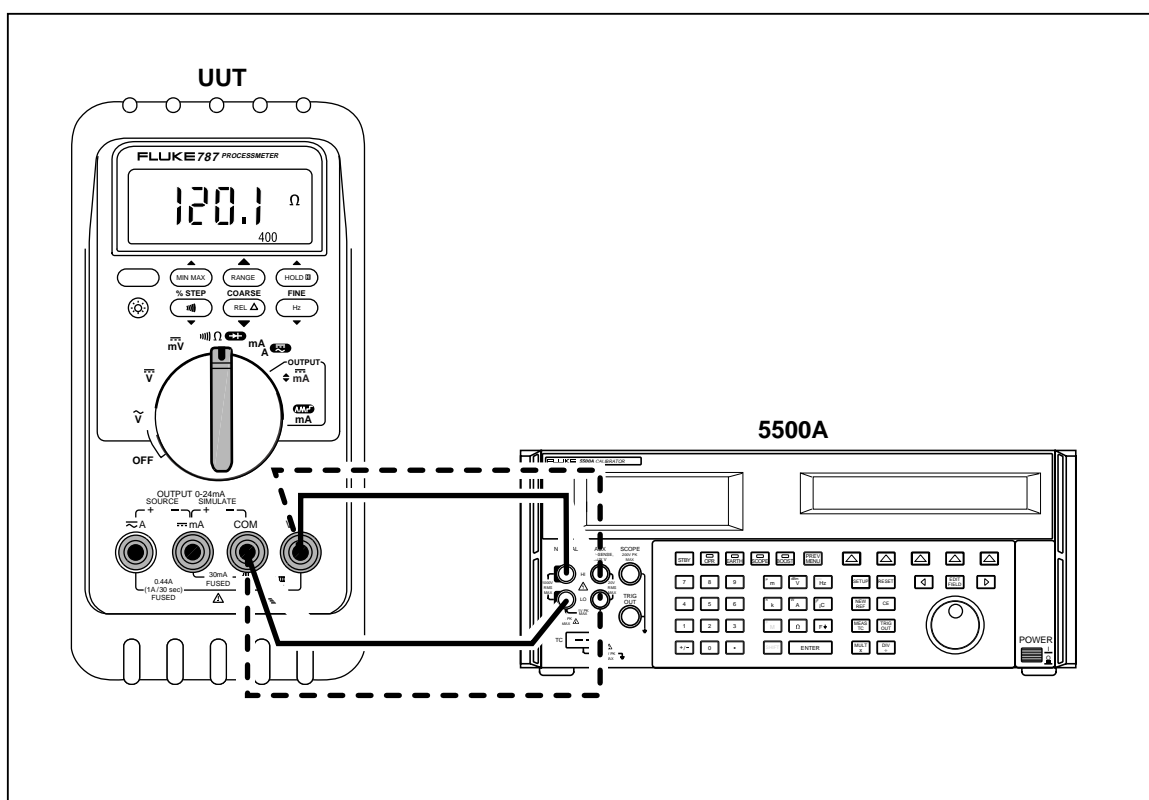

Figure 8. Resistance Measurement Test Connections

LT004F.EPS

Table 7. Resistance Measurement Test Using a 5500A or 5520A Calibrator

787 Range	Calibrator Resistance	Calibrator Compensation Mode	Minimum Reading	Maximum Reading
400 Ω	120 Ω	2-Wire	119.6 Ω	120.4 Ω
400 Ω	300 Ω	2-Wire	299.2 Ω	300.8 Ω
4 kΩ	1.2 kΩ	2-Wire	1.197 kΩ	1.203 kΩ
4 kΩ	3 kΩ	2-Wire	2.993 kΩ	3.007 kΩ
40 kΩ	12 kΩ	2-Wire	11.97 kΩ	12.03 kΩ
40 kΩ	30 kΩ	2-Wire	29.93 kΩ	30.07 kΩ
400 kΩ	120 kΩ	OFF	119.7 kΩ	120.3 kΩ
400 kΩ	200 kΩ	OFF	199.5 kΩ	200.5 kΩ
400 kΩ	300 kΩ	OFF	299.3 kΩ	300.7 kΩ
4 MΩ	1.2 MΩ	OFF	1.993 MΩ	1.207 MΩ
4 MΩ	3.0 MΩ	OFF	2.986 MΩ	3.014 MΩ
40 MΩ	12 MΩ	OFF	11.67 MΩ	12.33 MΩ
40 MΩ	30 MΩ	OFF	29.22 MΩ	30.78 MΩ

DC Millivolts Measurement Test

1. Put the calibrator in Standby (**STBY**) mode.
2. Put the UUT rotary switch in the $m\bar{V}$ (dc Millivolts) position.
3. Connect the calibrator to the **COM** and **V Ω →** terminals on the UUT as shown in Figure 9.
4. Apply the values from the calibrator shown in Table 8 and compare the readings on the UUT to the acceptable readings shown.

Table 8. DC mV Test

787 Range	Calibrator DC Voltage	Minimum Reading	Maximum Reading
No Range Switching	100 mV	99.8 mV	100.2 mV
No Range Switching	300 mV	299.6 mV	300.4 mV

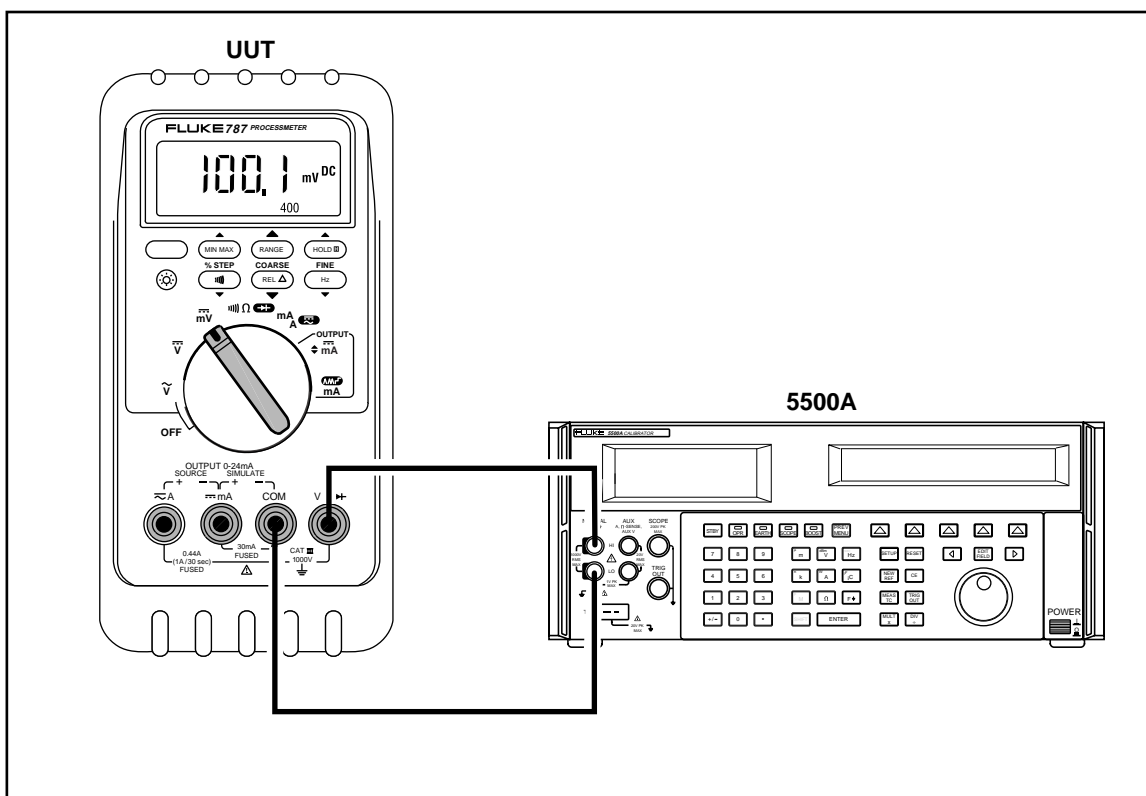

Figure 9. DC mV Measurement Test Connections

LT0005F.EPS

DC Volts Measurement Tests

⚠ Warning

To avoid possible electrical shock or personal injury:

- Some of the verification tests involve the use of high voltages and should be performed by qualified personnel only.
 - Always place the calibrator in the Standby (STBY) mode between tests and before handling the test connections or test cables.
1. Put the calibrator in Standby (**STBY**) mode.
 2. Put the UUT rotary switch in the \bar{V} (dc volts) position; select the autoranging mode.
 3. Connect the calibrator to the **COM** and **V Ω →** terminals on the UUT as shown in Figure 10.
 4. Apply the values from the calibrator shown in Table 9 and compare the readings on the UUT to the acceptable readings shown.

Table 9. DC Volts Test

787 Range	Calibrator DC Voltage	Minimum Reading	Maximum Reading
4 V dc	1 V	0.998 V	1.002 V
4 V dc	3 V	2.996 V	3.004 V
40 V dc	10 V	9.98 V	10.02 V
40 V dc	30 V	29.96 V	30.04 V
400 V dc	100 V	99.8 V	100.2 V
400 V dc	300 V	299.6 V	300.4 V
1000 V dc	100 V	99	101
1000 V dc	800 V	798	802

AC Volts Measurement Test

⚠ Warning

To avoid possible electrical shock or personal injury:

- Some of the verification tests involve the use of high voltages and should be performed by qualified personnel only.
 - Always place the calibrator in the Standby (STBY) mode between tests and before handling the test connections or test cables.
1. Put the calibrator in Standby (**STBY**) mode.
 2. Put the UUT rotary switch in the \tilde{V} (ac volts) position.
 3. Connect the calibrator to the **COM** and **V Ω →** terminals on the UUT as shown in Figure 10.
 4. Apply the values from the calibrator shown in Table 10 and compare the readings on the UUT to the acceptable readings shown.

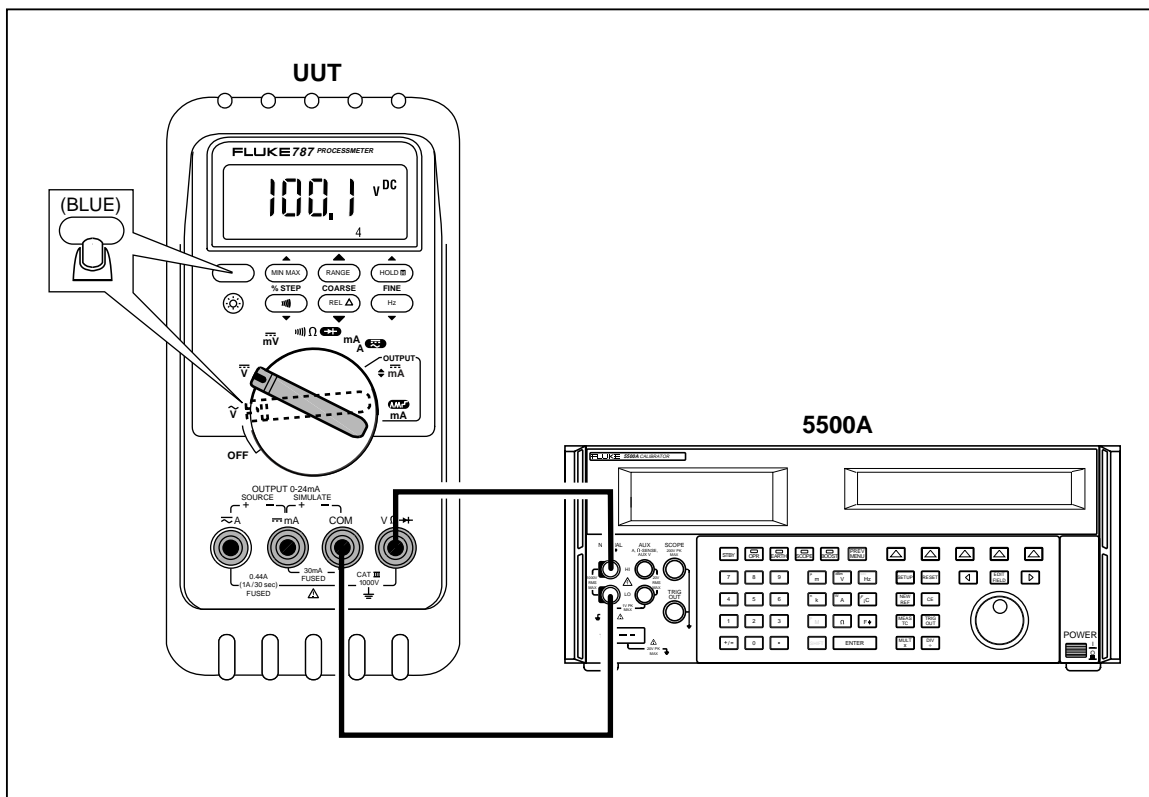

LT0009F.EPS

Figure 10. AC/DC Voltage Measurement Test Connections

Table 10. AC Volts Test

787 Range	Calibrator Voltage and Frequency	Minimum Acceptable Reading	Maximum Acceptable Reading
400 mV ac	100 mV @ 60 Hz	98.9 mV	101.1 mV
400 mV ac	300 mV @ 60 Hz	297.5 mV	302.5 mV
4 V ac	1 V @ 60 Hz	0.991 V	1.009 V
4 V ac	2 V @ 60 Hz	1.984 V	2.016 V
4 V ac	3 V @ 60 Hz	2.977 V	3.023 V
40 V ac	10 V @ 60 Hz	9.91 V	10.09 V
40 V ac	30 V @ 60 Hz	29.77 V	30.23 V
400 V ac	100 V @ 60 Hz	99.1 V	100.9 V
400 V ac	300 V @ 60 Hz	297.7 V	302.3 V
1000 V ac	100 V @ 60 Hz	97	103
1000 V ac	800 V @ 60 Hz	792	808

Frequency Measurement Test

1. Put the calibrator in Standby (**STBY**) mode.
2. Put the UUT rotary switch in the \tilde{V} (ac volts) position.
3. Press **Hz** to toggle to the frequency measurement function.
4. Connect the calibrator to the **COM** and **V Ω →** terminals on the UUT as shown in Figure 11.
5. Apply the values from the calibrator shown in Table 11 and compare the readings on the UUT to the acceptable readings shown.

Table 11. Frequency Measurement Test

787 Range	Calibrator Voltage and Frequency	Minimum Acceptable Reading	Maximum Acceptable Reading
199.99 Hz	5 V @ 100 Hz	99.98 Hz	100.02 Hz
1999.9 Hz	5 V @ 1000 Hz	999.8 Hz	1000.2 Hz
19.999 kHz	5 V @ 10 kHz	9.998 kHz	10.002 kHz

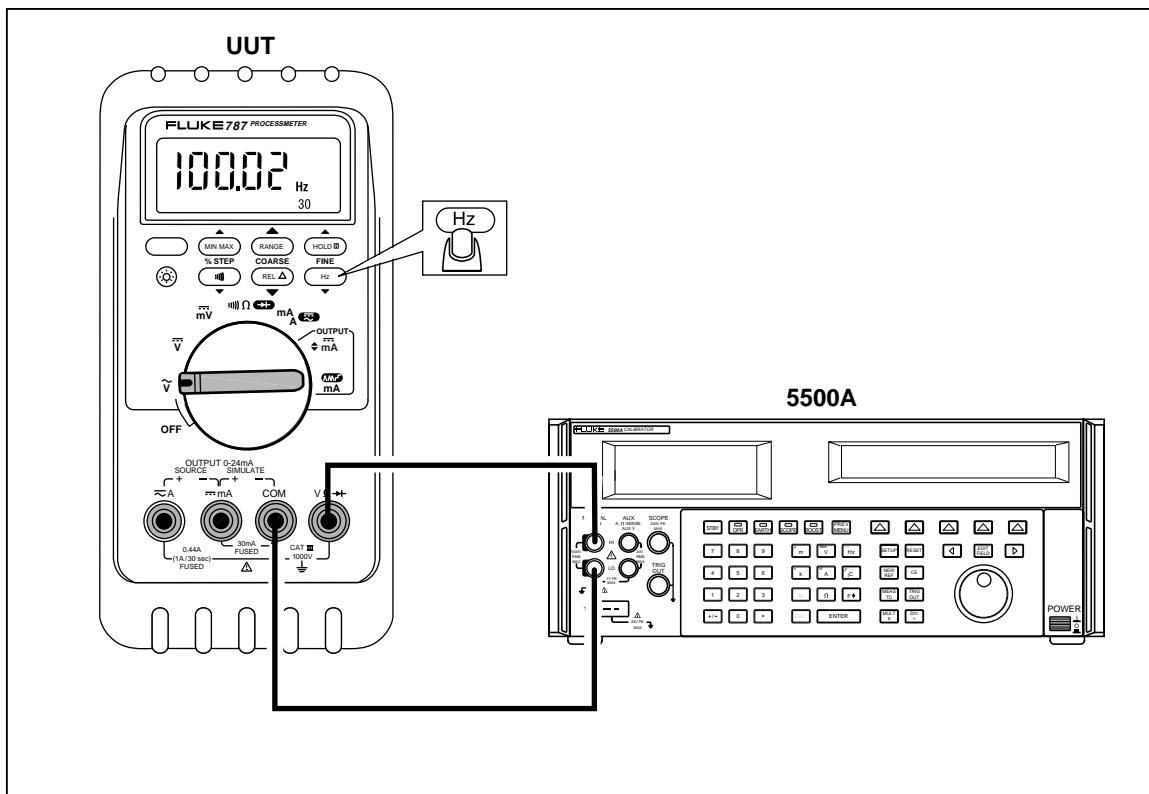

Figure 11. Frequency Measurement Test Connections

LT010F.EPS

Calibration

The 787 Processmeter is calibrated using a closed-case, automated procedure, that requires Fluke's *MET/CAL Calibration Software* and the 787 Calibration Module.

Calibrate your ProcessMeter once a year to ensure that it performs according to its specifications.

⚠ Warning

To avoid possible electrical shock or personal injury:

- **Some of the verification tests involve the use of high voltages and should be performed by qualified personnel only.**
- **Always place the calibrator in the Standby (STBY) mode between tests and before handling the test connections or test cables.**

Preparing for Calibration

⚠ Warning

To avoid possible electric shock or personal injury:

- **DO NOT use the ProcessMeter or the Calibration Module if either looks damaged.**
- **Before proceeding with the verification tests, inspect the ProcessMeter and the Calibration Module for damage, especially around the input terminals.**
- **Look for cracks, missing plastic, or damaged insulation. If damage is detected, do not continue; contact Fluke to arrange to have the ProcessMeter or Calibration Module serviced.**
- **Make sure that the battery door on the ProcessMeter is closed and latched before using the ProcessMeter.**
- **Inspect the test leads and test connections for damaged insulation or exposed metal.**
- **Check the test leads for continuity. Replace damaged test leads as necessary.**
- **Do not use the ProcessMeter or the Calibration Module if either appears to operate abnormally. Protection designed into the ProcessMeter and Calibration Module might be impaired. If in doubt have the ProcessMeter or Calibration Module serviced.**
- **To avoid electrical shock, always place the calibrator in the Standby (STBY) mode between tests and before handling the test connections or test cables.**
- **Some of the verification tests involve the use of high voltages and should be performed by qualified personnel only.**

Note

The calibration procedures assume that the person performing them knows how to use the 787 ProcessMeter and the required equipment. Do not attempt to calibrate the ProcessMeter unless you are qualified to do so.

Throughout the following, “UUT” (unit under test) refers to the 787 ProcessMeter; the word “multimeter” is reserved for the digital multimeter identified in the required equipment listed in Table 2.

Calibration should be performed in an RF field <1 V/m such as a laboratory environment.

To prepare for calibration, do the following:

1. Make sure that you have the required equipment available (see Table 2)and that the *MET/CAL Calibration Software* is properly loaded on your PC.
2. Make sure that both fuses in the UUT are intact. See “Checking and Replacing Fuses” earlier in this manual.
3. Connect the Calibrator to the PC using an IEEE-488 cable.
4. Turn on and warm up the calibrator as required by its specifications.
5. Remove all input cables from the front of the UUT.
6. Make sure that the UUT is in an ambient temperature between 18 °C and 28 °C (64.4 °F and 82.4 °F).

Installing the 787 Calibration Module

During the calibration procedure, the UUT communicates over the battery cable with the 787 Calibration Module (hereafter referred to as the “Calibration Module”) via a single-duplex, RS-232 interface.

The Calibration Module contains a circuit that both optically isolates the computer’s communication port from the UUT and converts the RS-232 signals to the appropriate format for communication with the UUT.

⚠Warning

To avoid possible electrical shock or personal injury:

- **To maintain safe conditions during calibration, the 787 Calibration Module must be properly attached to the UUT’s battery lead connector, and the battery door on the ProcessMeter must be secured. See Figure 12.**
- **When performing the following procedure, only use the battery eliminator provided with the Calibration Module (see Table 2). A generic battery eliminator might pose a safety hazard.**

To install the 787 Calibration Module, do the following while referring to Figures 12 and 13 as necessary:

1. Remove all input cables from the front of the UUT and open the battery door on the UUT.
2. Remove the battery from the battery receptacle of the UUT and unplug the battery from the battery cable connector.

3. Plug the battery connector from the UUT into the connector on the battery door of the Calibration Module.
4. Attach the battery door on the Calibration Module cable to the UUT.
5. Connect Calibration Module to the appropriate communication port on the PC, using an RS-232 9-pin, null modem cable. (See Figure 13.)

Note

The calibration procedure does not support the UUT port on the Fluke 5500A and 5520A calibrators.

6. Connect the battery eliminator to the Calibration Module, and plug the battery eliminator into an AC outlet.
7. Turn the rotary switch on the UUT to the \tilde{V} position and warm up the UUT for five minutes.
8. Start MET/CAL and select the calibration procedure that matches the calibrator and multimeter in use.

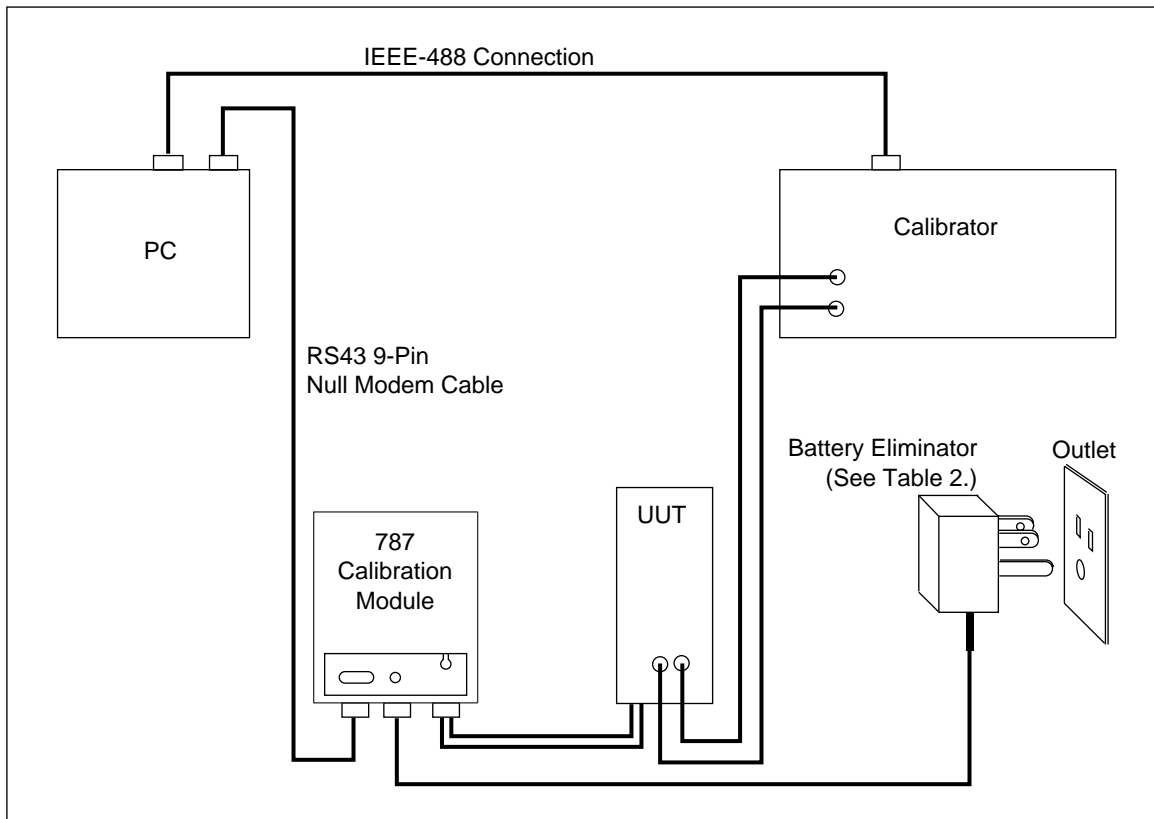

Figure 12. Calibration Connections for the 787 ProcessMeter

LT015F.EPS

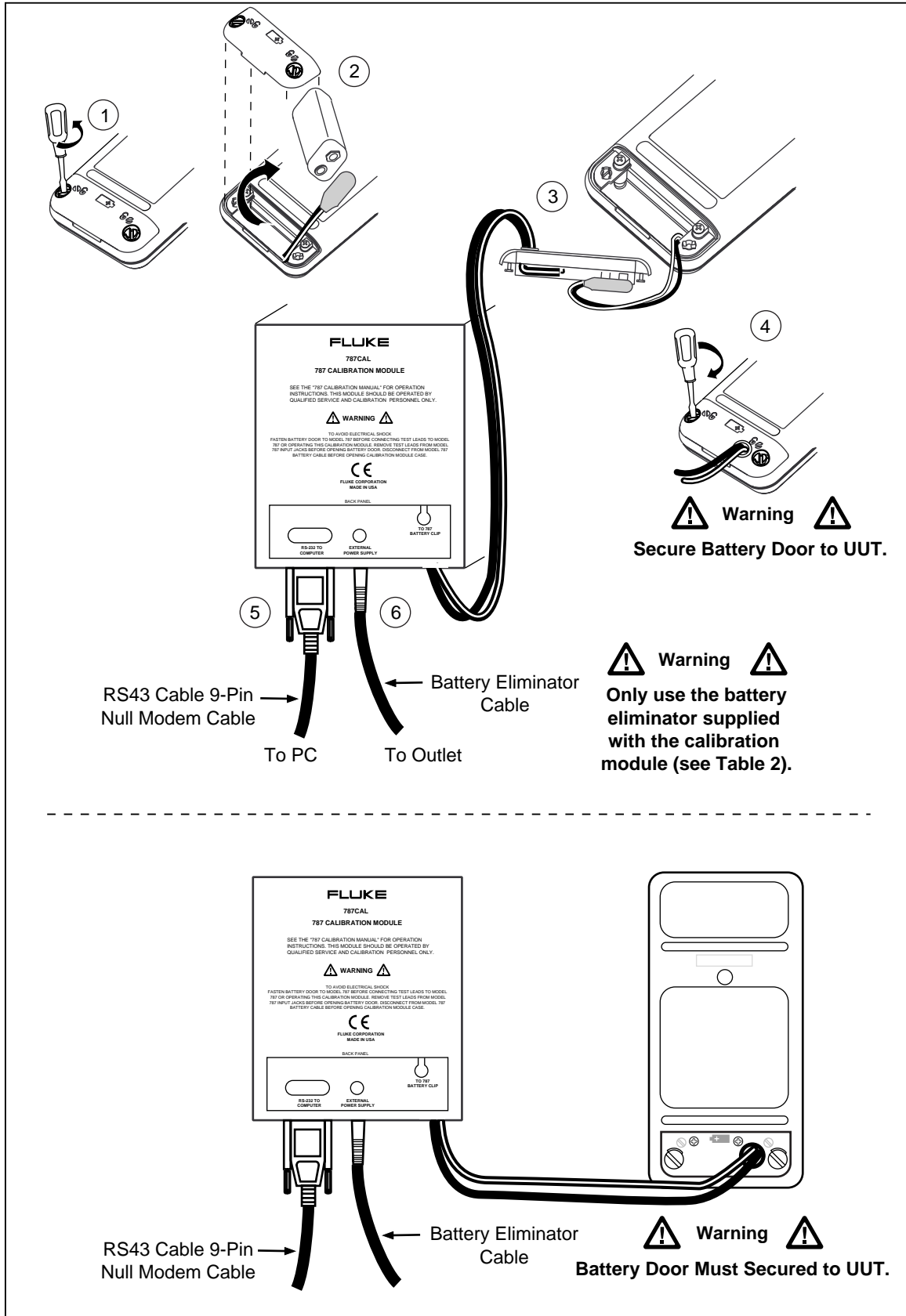

Figure 13. Connecting the 787 Calibration Module to the UUT

LT011F.EPS

Using the MET/CAL Calibration Software

To calibrate the UUT using the *MET/CAL Calibration Software*, start MET/CAL and follow the prompts.

For each function being calibrated, you will be prompted to set the UUT rotary switch to the correct position, and to make the appropriate connections between the calibrator, other required equipment, and the UUT.

Except for positioning the rotary switch and making the proper connections, the calibration process is completely automated.

⚠ Warning

The *MET/CAL Calibration Software* program automatically puts the Calibrator in Standby (STBY) mode before prompting you to change connections.

To ensure your safety, however, always check the Calibrator to make sure that it actually is in the Standby (STBY) before changing connections with the UUT and all other equipment used in calibration.

Replaceable Parts

When servicing this ProcessMeter, use only the replacement parts specified. User-replaceable parts are listed in Table 12 and shown in Figure 14.

Table 12. Replacement Parts

Item	Description	Fluke No.	Quantity
BT1	9V battery, ANSI/NEDA 1604A or IEC 6LR61	614487	1
CG81Y	Holster, Yellow	CG81G	1
⚠F1, 2	Fuse, 440 mA, 1000 V fast-blow	943121	2
MP85	Case top	619962	1
MP86	Case bottom	619939	1
H2, 3, 4	Case screw	832246	3
MP89, 90	Non-skid foot	824466	2
MP8	O-ring for input/output receptacle	831933	1
MP92	Battery door	619947	1
H5, 6	Battery door fasteners	948609	2
S1	Keypad	646932	1
TL75	Standard test lead set	TL75	1
AC70A	Alligator clips for use with TL75 test lead set	AC70A	1
TL20	Industrial test lead set	TL20	Option
TM1	Product Overview Manual	1586717	1
TM2	Users Manual (CD-ROM)	1586721	1
TM3	Calibration Manual (not shown)	641891	Option

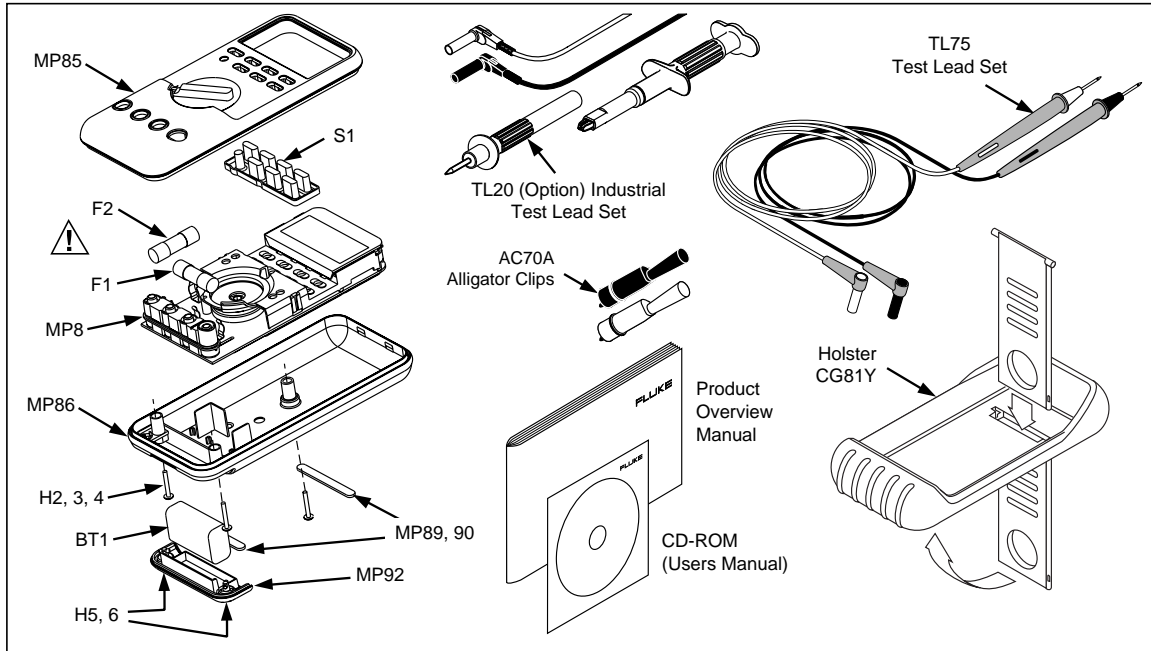

LT012F.EPS

Figure 14. Replacement Parts

Компания «Life Electronics» занимается поставками электронных компонентов импортного и отечественного производства от производителей и со складов крупных дистрибьюторов Европы, Америки и Азии.

С конца 2013 года компания активно расширяет линейку поставок компонентов по направлению коаксиальный кабель, кварцевые генераторы и конденсаторы (керамические, пленочные, электролитические), за счёт заключения дистрибьюторских договоров

Мы предлагаем:

- Конкуренспособные цены и скидки постоянным клиентам.
- Специальные условия для постоянных клиентов.
- Подбор аналогов.
- Поставку компонентов в любых объемах, удовлетворяющих вашим потребностям.
- Приемлемые сроки поставки, возможна ускоренная поставка.
- Доставку товара в любую точку России и стран СНГ.
- Комплексную поставку.
- Работу по проектам и поставку образцов.
- Формирование склада под заказчика.
- Сертификаты соответствия на поставляемую продукцию (по желанию клиента).
- Тестирование поставляемой продукции.
- Поставку компонентов, требующих военную и космическую приемку.
- Входной контроль качества.
- Наличие сертификата ISO.

В составе нашей компании организован Конструкторский отдел, призванный помогать разработчикам, и инженерам.

Конструкторский отдел помогает осуществить:

- Регистрацию проекта у производителя компонентов.
- Техническую поддержку проекта.
- Защиту от снятия компонента с производства.
- Оценку стоимости проекта по компонентам.
- Изготовление тестовой платы монтаж и пусконаладочные работы.



Тел: +7 (812) 336 43 04 (многоканальный)

Email: org@lifeelectronics.ru

www.lifeelectronics.ru