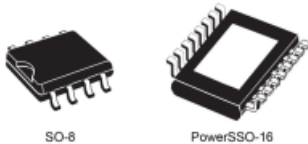



## High-side driver with MultiSense analog feedback for automotive applications



### Features

Max transient supply voltage	$V_{CC}$	40 V
Operating voltage range	$V_{CC}$	4 to 28 V
Typ. on-state resistance (per Ch)	$R_{ON}$	40 m $\Omega$
Current limitation (typ)	$I_{LIMH}$	34 A
Standby current (max)	$I_{STBY}$	0.5 $\mu$ A

- AEC-Q100 qualified 
- General
  - Single channel smart high-side driver with MultiSense analog feedback
  - Very low standby current
  - Compatible with 3 V and 5 V CMOS outputs
- MultiSense diagnostic functions
  - Multiplexed analog feedback of: load current with high precision proportional current mirror,  $V_{CC}$  supply voltage and  $T_{CHIP}$  device temperature
  - Overload and short to ground (power limitation) indication
  - Thermal shutdown indication
  - OFF-state open-load detection
  - Output short to  $V_{CC}$  detection
  - Sense enable/disable
- Protections
  - Undervoltage shutdown
  - Overvoltage clamp
  - Load current limitation
  - Self limiting of fast thermal transients
  - Configurable latch-off on overtemperature or power limitation with dedicated fault reset pin
  - Loss of ground and loss of  $V_{CC}$
  - Reverse battery with external components
  - Electrostatic discharge protection

#### Product status link

[VN7040AJ](#)
[VN7040AS](#)

### Applications

- All types of Automotive resistive, inductive and capacitive loads
- Specially intended for Automotive Turn Indicators (up to P27W or SAE1156 and R5W paralleled or LED Rear Combinations)
- Protected supply for ADAS systems: radars and sensors

### Description

The devices are single channel high-side drivers manufactured using ST proprietary VIPower M0-7 technology and housed in PowerSSO-16 and SO-8 packages. The

devices are designed to drive 12 V automotive grounded loads through a 3 V and 5 V CMOS-compatible interface, and to provide protection and diagnostics.

The devices integrate advanced protective functions such as load current limitation, overload active management by power limitation and overtemperature shutdown with configurable latch-off.

A  $\overline{\text{FaultRST}}$  pin unlatches the output in case of fault or disables the latch-off functionality.

A dedicated multifunction multiplexed analog output pin delivers sophisticated diagnostic functions including high precision proportional load current sense, supply voltage feedback and chip temperature sense, in addition to the detection of overload and short circuit to ground, short to  $V_{CC}$  and OFF-state open-load.

A sense enable pin allows OFF-state diagnosis to be disabled during the module low-power mode as well as external sense resistor sharing among similar devices.

# 1 Block diagram and pin description

Figure 1. Block diagram

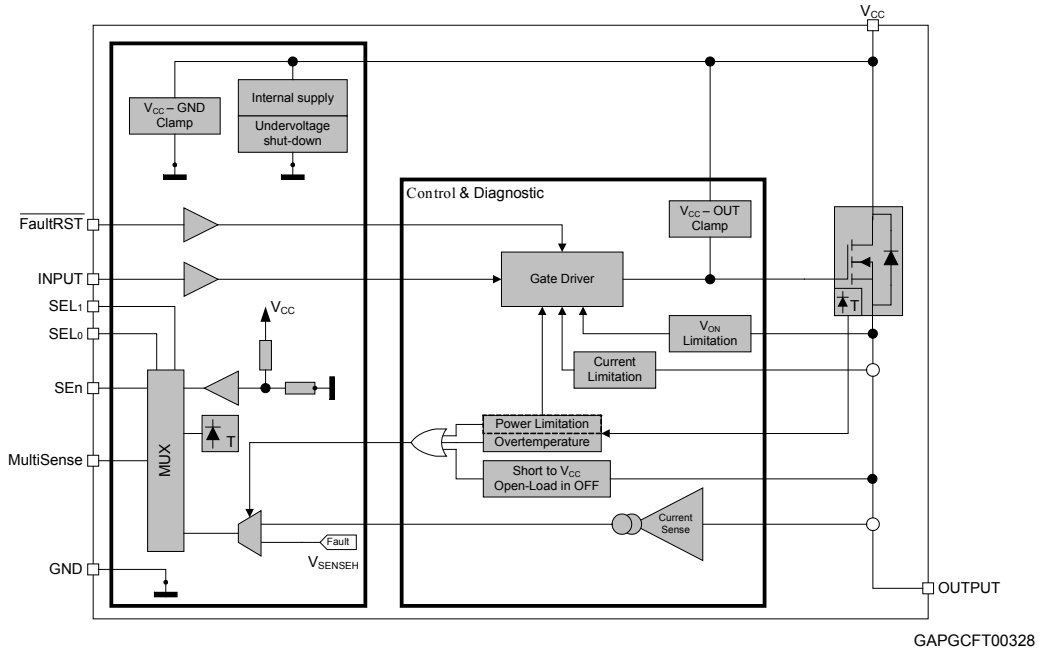
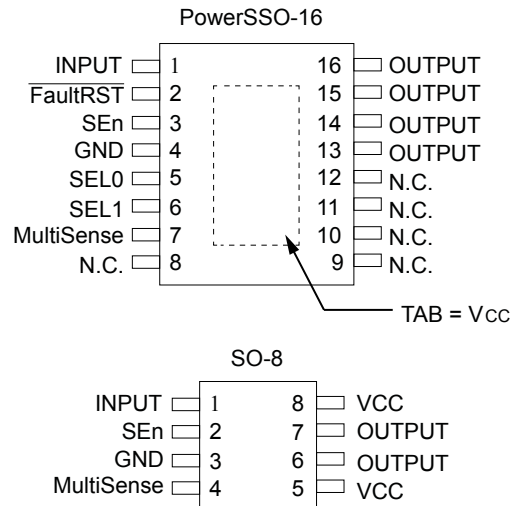


Table 1. Pin functions

Name	Function
V <sub>CC</sub>	Battery connection.
OUTPUT	Power outputs.
GND	Ground connection. Must be reverse battery protected by an external diode / resistor network.
INPUT	Voltage controlled input pin with hysteresis, compatible with 3 V and 5 V CMOS outputs. It controls output switch state.
MultiSense	Multiplexed analog sense output pin; it delivers a current proportional to the selected diagnostic: load current, supply voltage or chip temperature.
SEn	Active high compatible with 3 V and 5 V CMOS outputs pin; it enables the MultiSense diagnostic pin.
SEL <sub>0,1</sub>	Active high compatible with 3 V and 5 V CMOS outputs pin; they address the MultiSense multiplexer.
FaultRST	Active low compatible with 3 V and 5 V CMOS outputs pin; it unlatches the output in case of fault; If kept low, sets the outputs in auto-restart mode.

Figure 2. Configuration diagram (top view)



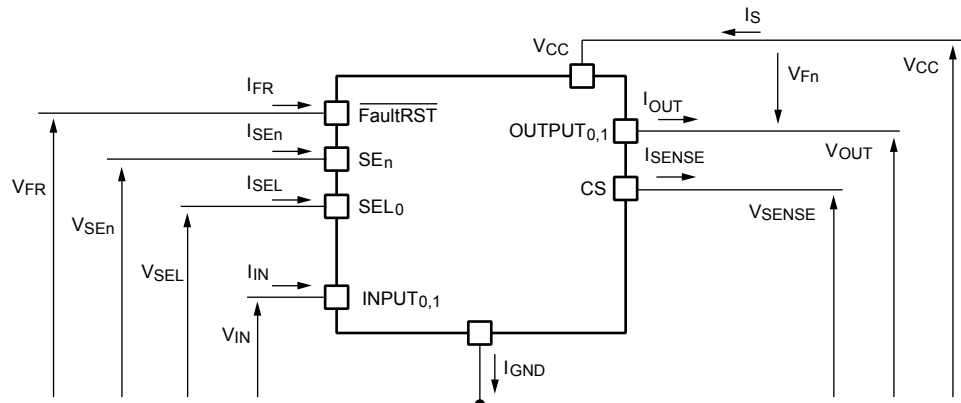
GAPG2601151129CFT

Table 2. Suggested connections for unused and not connected pins

Connection / pin	MultiSense	N.C.	Output	Input	SEn, SELx, FaultRST
Floating	Not allowed	X <sup>(1)</sup>	X	X	X
To ground	Through 1 kΩ resistor	X	Not allowed	Through 15 kΩ resistor	Through 15 kΩ resistor

1. X: do not care.

## 2 Electrical specification

**Figure 3. Current and voltage conventions**


GADG2203170950PS

Note:  $V_F = V_{OUT} - V_{CC}$  during reverse battery condition.

### 2.1 Absolute maximum ratings

Stressing the device above the rating listed in [Table 3. Absolute maximum ratings](#) may cause permanent damage to the device. These are stress ratings only and operation of the device at these or any other conditions above those indicated in the operating sections of this specification is not implied. Exposure to the conditions in table below for extended periods may affect device reliability.

**Table 3. Absolute maximum ratings**

Symbol	Parameter	Value	Unit
$V_{CC}$	DC supply voltage	38	V
$-V_{CC}$	Reverse DC supply voltage	0.3	
$V_{CCPK}$	Maximum transient supply voltage (ISO 16750-2:2010 Test B clamped to 40 V; $R_L = 4 \Omega$ )	40	V
$V_{CCJS}$	Maximum jump start voltage for single pulse short-circuit protection	28	V
$-I_{GND}$	DC reverse ground pin current	200	mA
$I_{OUT}$	OUTPUT DC output current	Internally limited	A
$-I_{OUT}$	Reverse DC output current	11	
$I_{IN}$	INPUT DC input current	-1 to 10	mA
$I_{SEn}$	SEn DC input current		
$I_{SEL}$	SEL <sub>0,1</sub> DC input current		
$I_{FR}$	FaultRST DC input current		
$V_{FR}$	FaultRST DC input voltage	7.5	V
$I_{SENSE}$	MultiSense pin DC output current ( $V_{GND} = V_{CC}$ and $V_{SENSE} < 0 V$ )	10	mA
	MultiSense pin DC output current in reverse ( $V_{CC} < 0 V$ )	-20	

Symbol	Parameter	Value	Unit
E <sub>MAX</sub>	Maximum switching energy (single pulse) (T <sub>DEMAG</sub> = 0.4 ms; T <sub>jstart</sub> = 150 °C)	36	mJ
V <sub>ESD</sub>	Electrostatic discharge (JEDEC 22A-114F)	4000	V
	• INPUT	2000	V
	• MultiSense	4000	V
	• SEn, SEL <sub>0,1</sub> , FaultRST	4000	V
	• OUTPUT	4000	V
	• V <sub>CC</sub>	4000	V
V <sub>ESD</sub>	Charge device model (CDM-AEC-Q100-011)	750	V
T <sub>j</sub>	Junction operating temperature	-40 to 150	°C
T <sub>stg</sub>	Storage temperature	-55 to 150	

## 2.2 Thermal data

**Table 4. Thermal data**

Symbol	Parameter	Typ. value		Unit
		SO-8	PowerSSO-16	
R <sub>thj-board</sub>	Thermal resistance junction-board (JEDEC JESD 51-8) <sup>(1)</sup>	29	6.2	°C/W
R <sub>thj-amb</sub>	Thermal resistance junction-ambient (JEDEC JESD 51-2) <sup>(2)</sup>	67	57	
R <sub>thj-amb</sub>	Thermal resistance junction-ambient (JEDEC JESD 51-2)	45	23.5	

1. Device mounted on four-layers 2s2p PCB

2. Device mounted on two-layers 2s0p PCB with 2 cm<sup>2</sup> heatsink copper trace

## 2.3 Main electrical characteristics

7 V < V<sub>CC</sub> < 28 V; -40°C < T<sub>j</sub> < 150°C, unless otherwise specified.

All typical values refer to V<sub>CC</sub> = 13 V; T<sub>j</sub> = 25°C, unless otherwise specified.

**Table 5. Power section**

Symbol	Parameter	Test conditions	Min.	Typ.	Max.	Unit
V <sub>CC</sub>	Operating supply voltage		4	13	28	V
V <sub>USD</sub>	Undervoltage shutdown				4	V
V <sub>USDReset</sub>	Undervoltage shutdown reset				5	V
V <sub>USDhyst</sub>	Undervoltage shutdown hysteresis			0.3		V
R <sub>ON</sub>	On-state resistance	I <sub>OUT</sub> = 2.5 A; T <sub>j</sub> = 25°C		40		mΩ
		I <sub>OUT</sub> = 2.5 A; T <sub>j</sub> = 150°C			80	
		I <sub>OUT</sub> = 2.5 A; V <sub>CC</sub> = 4 V; T <sub>j</sub> = 25°C			60	
V <sub>clamp</sub>	Clamp voltage	I <sub>S</sub> = 20 mA; 25°C < T <sub>j</sub> < 150°C	41	46	52	V
		I <sub>S</sub> = 20 mA; T <sub>j</sub> = -40°C	38			V

Symbol	Parameter	Test conditions	Min.	Typ.	Max.	Unit
$I_{STBY}$	Supply current in standby at $V_{CC} = 13\text{ V}$ <sup>(1)</sup>	$V_{CC} = 13\text{ V};$ $V_{IN} = V_{OUT} = V_{FR} = V_{SEn} = 0\text{ V};$ $V_{SEL0,1} = 0\text{ V}; T_j = 25^\circ\text{C}$			0.5	$\mu\text{A}$
		$V_{CC} = 13\text{ V};$ $V_{IN} = V_{OUT} = V_{FR} = V_{SEn} = 0\text{ V};$ $V_{SEL0,1} = 0\text{ V}; T_j = 85^\circ\text{C}$ <sup>(2)</sup>			0.5	
		$V_{CC} = 13\text{ V};$ $V_{IN} = V_{OUT} = V_{FR} = V_{SEn} = 0\text{ V};$ $V_{SEL0,1} = 0\text{ V}; T_j = 125^\circ\text{C}$			3	
$t_{D\_STBY}$	Standby mode blanking time	$V_{CC} = 13\text{ V};$ $V_{IN} = V_{OUT} = V_{FR} = V_{SEL0,1} = 0\text{ V};$ $V_{SEn} = 5\text{ V to } 5\text{ V}$	60	300	550	$\mu\text{s}$
$I_{S(ON)}$	Supply current	$V_{CC} = 13\text{ V}; V_{SEn} = 0\text{ V};$ $V_{SEL0,1} = V_{FR} = 0\text{ V}; V_{IN} = 5\text{ V}; I_{OUT} = 0\text{ A}$		3	5	$\text{mA}$
$I_{GND(ON)}$	Control stage current consumption in ON-state. All channels active.	$V_{CC} = 13\text{ V}; V_{SEn} = 5\text{ V};$ $V_{FR} = V_{SEL0,1} = 0\text{ V}; V_{IN} = 5\text{ V}; I_{OUT} = 2\text{ A}$			6	$\text{mA}$
$I_{L(off)}$	Off-state output current at $V_{CC} = 13\text{ V}$	$V_{IN} = V_{OUT} = 0\text{ V}; V_{CC} = 13\text{ V}; T_j = 25^\circ\text{C}$	0	0.01	0.5	$\mu\text{A}$
		$V_{IN} = V_{OUT} = 0\text{ V}; V_{CC} = 13\text{ V}; T_j = 125^\circ\text{C}$	0		3	
$V_F$	Output - $V_{CC}$ diode voltage	$I_{OUT} = -2.5\text{ A}; T_j = 150^\circ\text{C}$			0.7	$\text{V}$

1. PowerMOS leakage included.
2. Parameter specified by design; not subjected to production test.

**Table 6. Switching**

$V_{CC} = 13\text{ V}; -40^\circ\text{C} < T_j < 150^\circ\text{C}$ , unless otherwise specified						
Symbol	Parameter	Test conditions	Min.	Typ.	Max.	Unit
$t_{d(on)}$ <sup>(1)</sup>	Turn-on delay time at $T_j = 25^\circ\text{C}$	$R_L = 5.2\ \Omega$	10	40	120	$\mu\text{s}$
$t_{d(off)}$ <sup>(1)</sup>	Turn-off delay time at $T_j = 25^\circ\text{C}$		10	35	100	
$(dV_{OUT}/dt)_{on}$ <sup>(1)</sup>	Turn-on voltage slope at $T_j = 25^\circ\text{C}$	$R_L = 5.2\ \Omega$	0.1	0.24	0.7	$\text{V}/\mu\text{s}$
$(dV_{OUT}/dt)_{off}$ <sup>(1)</sup>	Turn-off voltage slope at $T_j = 25^\circ\text{C}$		0.1	0.28	0.7	
$W_{ON}$	Switching energy losses at turn-on ( $t_{won}$ )	$R_L = 5.2\ \Omega$	—	0.32	0.4 <sup>(2)</sup>	$\text{mJ}$
$W_{OFF}$	Switching energy losses at turn-off ( $t_{woff}$ )	$R_L = 5.2\ \Omega$	—	0.33	0.4 <sup>(2)</sup>	$\text{mJ}$
$t_{SKEW}$ <sup>(1)</sup>	Differential Pulse skew ( $t_{PHL} - t_{PLH}$ )	$R_L = 5.2\ \Omega$	-40	10	60	$\mu\text{s}$

1. See Figure 6. Switching time and Pulse skew.
2. Parameter guaranteed by design and characterization; not subjected to production test.

**Table 7. Logic inputs**

$7\text{ V} < V_{CC} < 28\text{ V}; -40^\circ\text{C} < T_j < 150^\circ\text{C}$						
Symbol	Parameter	Test conditions	Min.	Typ.	Max.	Unit
INPUT characteristics						
$V_{IL}$	Input low level voltage				0.9	$\text{V}$
$I_{IL}$	Low level input current	$V_{IN} = 0.9\text{ V}$	1			$\mu\text{A}$

7 V < V <sub>CC</sub> < 28 V; -40°C < T <sub>j</sub> < 150°C						
Symbol	Parameter	Test conditions	Min.	Typ.	Max.	Unit
V <sub>IH</sub>	Input high level voltage		2.1			V
I <sub>IH</sub>	High level input current	V <sub>IN</sub> = 2.1 V			10	μA
V <sub>I(hyst)</sub>	Input hysteresis voltage		0.2			V
V <sub>ICL</sub>	Input clamp voltage	I <sub>IN</sub> = 1 mA	5.3		7.2	V
		I <sub>IN</sub> = -1 mA		-0.7		
FaultRST characteristics (VN7040AJ only)						
V <sub>FRL</sub>	Input low level voltage				0.9	V
I <sub>FRL</sub>	Low level input current	V <sub>IN</sub> = 0.9 V	1			μA
V <sub>FRH</sub>	Input high level voltage		2.1			V
I <sub>FRH</sub>	High level input current	V <sub>IN</sub> = 2.1 V			10	μA
V <sub>FR(hyst)</sub>	Input hysteresis voltage		0.2			V
V <sub>FRCL</sub>	Input clamp voltage	I <sub>IN</sub> = 1 mA	5.3		7.5	V
		I <sub>IN</sub> = -1 mA		-0.7		
SEL <sub>0,1</sub> characteristics (7 V < V <sub>CC</sub> < 18 V) (VN7040AJ only)						
V <sub>SELL</sub>	Input low level voltage				0.9	V
I <sub>SELL</sub>	Low level input current	V <sub>IN</sub> = 0.9 V	1			μA
V <sub>SELH</sub>	Input high level voltage		2.1			V
I <sub>SELH</sub>	High level input current	V <sub>IN</sub> = 2.1 V			10	μA
V <sub>SEL(hyst)</sub>	Input hysteresis voltage		0.2			V
V <sub>SELCL</sub>	Input clamp voltage	I <sub>IN</sub> = 1 mA	5.3		7.2	V
		I <sub>IN</sub> = -1 mA		-0.7		
SEn characteristics (7 V < V <sub>CC</sub> < 18 V)						
V <sub>SEnL</sub>	Input low level voltage				0.9	V
I <sub>SEnL</sub>	Low level input current	V <sub>IN</sub> = 0.9 V	1			μA
V <sub>SEnH</sub>	Input high level voltage		2.1			V
I <sub>SEnH</sub>	High level input current	V <sub>IN</sub> = 2.1 V			10	μA
V <sub>SEn(hyst)</sub>	Input hysteresis voltage		0.2			V
V <sub>SEnCL</sub>	Input clamp voltage	I <sub>IN</sub> = 1 mA	5.3		7.2	V
		I <sub>IN</sub> = -1 mA		-0.7		



**Table 8. Protections**

7 V < V <sub>CC</sub> < 18 V; -40°C < T <sub>j</sub> < 150°C						
Symbol	Parameter	Test conditions	Min.	Typ.	Max.	Unit
I <sub>LIMH</sub>	DC short circuit current	V <sub>CC</sub> = 13 V	24	34	48	A
		4 V < V <sub>CC</sub> < 18 V <sup>(1)</sup>				
I <sub>LIML</sub>	Short circuit current during thermal cycling	V <sub>CC</sub> = 13 V; T <sub>R</sub> < T <sub>j</sub> < T <sub>TSD</sub>		13		
T <sub>TSD</sub>	Shutdown temperature		150	175	200	°C
T <sub>R</sub>	Reset temperature <sup>(1)</sup>		T <sub>RS</sub> + 1	T <sub>RS</sub> + 7		
T <sub>RS</sub>	Thermal reset of fault diagnostic indication	V <sub>FR</sub> = 0 V; V <sub>SEn</sub> = 5 V	135			
T <sub>HYST</sub>	Thermal hysteresis(T <sub>TSD</sub> - T <sub>R</sub> ) <sup>(1)</sup>			7		
ΔT <sub>J_SD</sub>	Dynamic temperature	T <sub>j</sub> = -40°C; V <sub>CC</sub> = 13 V		60		K
t <sub>LATCH_RST</sub>	Fault reset time for output unlatch (only for VN7040AJ) <sup>(1)</sup>	V <sub>FR</sub> = 5 V to 0 V; V <sub>SEn</sub> = 5 V; V <sub>IN</sub> = 5 V; V <sub>SEL0</sub> = 0 V; V <sub>SEL1</sub> = 0 V	3	10	20	μs
V <sub>DEMAG</sub>	Turn-off output voltage clamp	I <sub>OUT</sub> = 2 A; L = 6 mH; T <sub>j</sub> = -40°C	V <sub>CC</sub> - 38			V
		I <sub>OUT</sub> = 2 A; L = 6 mH; T <sub>j</sub> = 25°C to 150°C	V <sub>CC</sub> - 41	V <sub>CC</sub> - 46	V <sub>CC</sub> - 52	V
V <sub>ON</sub>	Output voltage drop limitation	I <sub>OUT</sub> = 0.25 A		20		mV

1. Parameter guaranteed by design and characterization; not subjected to production test.

**Table 9. MultiSense**

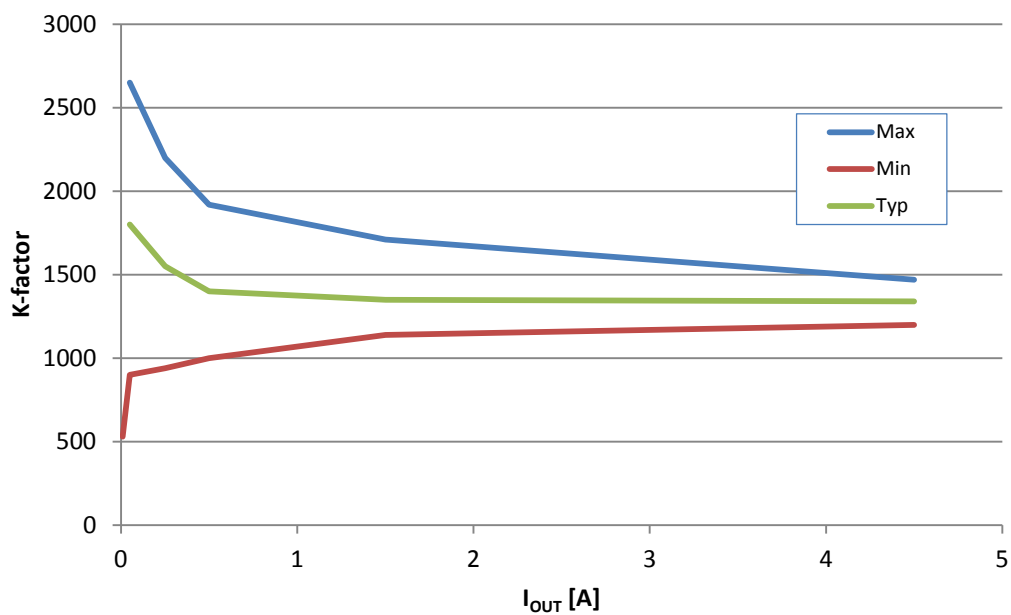
7 V < V <sub>CC</sub> < 18 V; -40°C < T <sub>j</sub> < 150°C						
Symbol	Parameter	Test conditions	Min.	Typ.	Max.	Unit
V <sub>SENSE_CL</sub>	MultiSense clamp voltage	V <sub>SEn</sub> = 0 V; I <sub>SENSE</sub> = 1 mA	-17		-12	V
		V <sub>SEn</sub> = 0 V; I <sub>SENSE</sub> = -1 mA		7		
CurrentSense characteristics						
K <sub>OL</sub>	I <sub>OUT</sub> /I <sub>SENSE</sub>	I <sub>OUT</sub> = 0.01 A; V <sub>SENSE</sub> = 0.5 V; V <sub>SEn</sub> = 5 V	530			
dK <sub>cal</sub> /K <sub>cal</sub> <sup>(1) (2)</sup>	Current sense ratio drift at calibration point	I <sub>OUT</sub> = 0.01 A to 0.03 A; I <sub>cal</sub> = 30 mA; V <sub>SENSE</sub> = 0.5 V; V <sub>SEn</sub> = 5 V	-30		30	%
K <sub>LED</sub>	I <sub>OUT</sub> /I <sub>SENSE</sub>	I <sub>OUT</sub> = 0.05 A; V <sub>SENSE</sub> = 0.5 V; V <sub>SEn</sub> = 5 V	900	1800	2650	
dK <sub>LED</sub> /K <sub>LED</sub> <sup>(1) (2)</sup>	Current sense ratio drift	I <sub>OUT</sub> = 0.05 A; V <sub>SENSE</sub> = 0.5 V; V <sub>SEn</sub> = 5 V	-25		25	%
K <sub>0</sub>	I <sub>OUT</sub> /I <sub>SENSE</sub>	I <sub>OUT</sub> = 0.25 A; V <sub>SENSE</sub> = 0.5 V; V <sub>SEn</sub> = 5 V	940	1550	2200	
dK <sub>0</sub> /K <sub>0</sub> <sup>(1) (2)</sup>	Current sense ratio drift	I <sub>OUT</sub> = 0.25 A; V <sub>SENSE</sub> = 0.5 V; V <sub>SEn</sub> = 5 V	-20		20	%
K <sub>1</sub>	I <sub>OUT</sub> /I <sub>SENSE</sub>	I <sub>OUT</sub> = 0.5 A; V <sub>SENSE</sub> = 4 V; V <sub>SEn</sub> = 5 V	1000	1400	1920	

7 V < V <sub>CC</sub> < 18 V; -40°C < T <sub>j</sub> < 150°C						
Symbol	Parameter	Test conditions	Min.	Typ.	Max.	Unit
dK <sub>1</sub> /K <sub>1</sub> <sup>(1) (2)</sup>	Current sense ratio drift	I <sub>OUT</sub> = 0.5 A; V <sub>SENSE</sub> = 4 V; V <sub>SEn</sub> = 5 V	-15		15	%
K <sub>2</sub>	I <sub>OUT</sub> /I <sub>SENSE</sub>	I <sub>OUT</sub> = 1.5 A; V <sub>SENSE</sub> = 4 V; V <sub>SEn</sub> = 5 V	1140	1350	1710	
dK <sub>2</sub> /K <sub>2</sub> <sup>(1) (2)</sup>	Current sense ratio drift	I <sub>OUT</sub> = 1.5 A; V <sub>SENSE</sub> = 4 V; V <sub>SEn</sub> = 5 V	-10		10	%
K <sub>3</sub>	I <sub>OUT</sub> /I <sub>SENSE</sub>	I <sub>OUT</sub> = 4.5 A; V <sub>SENSE</sub> = 4 V; V <sub>SEn</sub> = 5 V	1200	1340	1470	
dK <sub>3</sub> /K <sub>3</sub> <sup>(1) (2)</sup>	Current sense ratio drift	I <sub>OUT</sub> = 4.5 A; V <sub>SENSE</sub> = 4 V; V <sub>SEn</sub> = 5 V	-5		5	%
I <sub>SENSE0</sub>	MultiSense leakage current	MultiSense disabled: V <sub>SEn</sub> = 0 V	0		0.5	μA
		MultiSense disabled: -1 V < V <sub>SENSE</sub> < 5 V <sup>(1)</sup>	-0.5		0.5	
		MultiSense enabled: V <sub>SEn</sub> = 5 V; Channel ON; I <sub>OUT</sub> = 0 A; Diagnostic selected; V <sub>IN</sub> = 5 V; V <sub>SEL0</sub> = 0 V; V <sub>SEL1</sub> = 0 V; I <sub>OUT</sub> = 0 A	0		2	
		MultiSense enabled: V <sub>SEn</sub> = 5 V; Channel OFF; Diagnostic selected: V <sub>IN</sub> = 0 V; V <sub>SEL0</sub> = 0 V; V <sub>SEL1</sub> = 0 V	0		2	
V <sub>OUT_MSD</sub> <sup>(1)</sup>	Output voltage for MultiSense shutdown	V <sub>IN</sub> = 5 V; V <sub>SEn</sub> = 5 V; V <sub>SEL0</sub> = 0 V; V <sub>SEL1</sub> = 0 V; R <sub>SENSE</sub> = 2.7 kΩ; I <sub>OUT</sub> = 2.5 A		5		V
V <sub>SENSE_SAT</sub>	Multisense saturation voltage	V <sub>CC</sub> = 7 V; R <sub>SENSE</sub> = 2.7 kΩ; V <sub>SEn</sub> = 5 V; V <sub>IN</sub> = 5 V; V <sub>SEL0</sub> = 0 V; V <sub>SEL1</sub> = 0 V; I <sub>OUT</sub> = 4.5 A; T <sub>j</sub> = 150°C	5			V
I <sub>SENSE_SAT</sub> <sup>(1)</sup>	CS saturation current	V <sub>CC</sub> = 7 V; V <sub>SENSE</sub> = 4 V; V <sub>IN</sub> = 5 V; V <sub>SEn</sub> = 5 V; V <sub>SEL0</sub> = 0 V; V <sub>SEL1</sub> = 0 V; T <sub>j</sub> = 150°C	4			mA
I <sub>OUT_SAT</sub> <sup>(1)</sup>	Output saturation current	V <sub>CC</sub> = 7 V; V <sub>SENSE</sub> = 4 V; V <sub>IN</sub> = 5 V; V <sub>SEn</sub> = 5 V; V <sub>SEL0</sub> = 0 V; V <sub>SEL1</sub> = 0 V; T <sub>j</sub> = 150°C	6			A
OFF-state diagnostic						
V <sub>OL</sub>	OFF-state open-load voltage detection threshold	V <sub>IN</sub> = 0 V; V <sub>SEn</sub> = 5 V; V <sub>SEL0</sub> = 0 V; V <sub>SEL1</sub> = 0 V	2	3	4	V
I <sub>L(off2)</sub>	OFF-state output sink current	V <sub>IN</sub> = 0 V; V <sub>OUT</sub> = V <sub>OL</sub>	-100		-15	μA
t <sub>DSTKON</sub>	OFF-state diagnostic delay time from falling edge of INPUT (see <a href="#">Figure 9</a> . T <sub>DSTKON</sub> )	V <sub>IN</sub> = 5 V to 0 V; V <sub>SEn</sub> = 5 V; V <sub>SEL0</sub> = 0 V; V <sub>SEL1</sub> = 0 V; I <sub>OUT</sub> = 0 A; V <sub>OUT</sub> = 4 V	100	350	700	μs
t <sub>D_OL_V</sub>	Settling time for valid OFF- state open load diagnostic indication from rising edge of SEn	V <sub>IN</sub> = 0 V; V <sub>FR</sub> = 0 V; V <sub>SEL0</sub> = 0 V; V <sub>SEL1</sub> = 0 V; V <sub>OUT</sub> = 4 V; V <sub>SEn</sub> = 0 V to 5 V			60	μs
t <sub>D_VOL</sub>	OFF-state diagnostic delay time from rising edge of V <sub>OUT</sub>	V <sub>IN</sub> = 0 V; V <sub>SEn</sub> = 5 V; V <sub>SEL0</sub> = 0 V; V <sub>SEL1</sub> = 0 V; V <sub>OUT</sub> = 0 V to 4 V		5	30	μs
Chip temperature analog feedback (VN7040AJ only)						

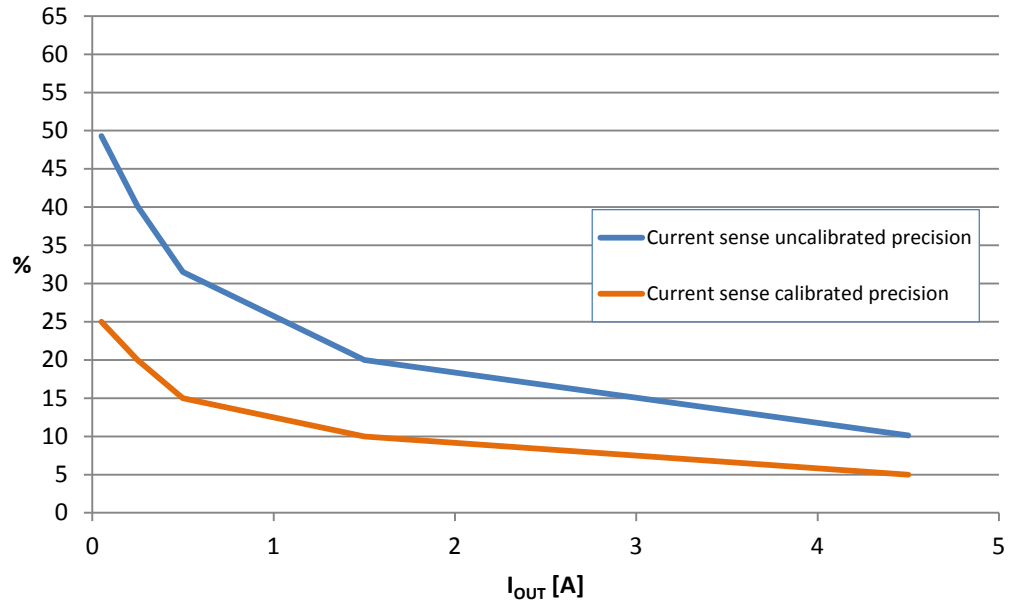
7 V < V <sub>CC</sub> < 18 V; -40°C < T <sub>j</sub> < 150°C						
Symbol	Parameter	Test conditions	Min.	Typ.	Max.	Unit
V <sub>SENSE_TC</sub>	MultiSense output voltage proportional to chip temperature	V <sub>SEn</sub> = 5 V; V <sub>SEL0</sub> = 0 V; V <sub>SEL1</sub> = 5 V; V <sub>IN</sub> = 0 V; R <sub>SENSE</sub> = 1 kΩ; T <sub>j</sub> = -40°C	2.325	2.41	2.495	V
		V <sub>SEn</sub> = 5 V; V <sub>SEL0</sub> = 0 V; V <sub>SEL1</sub> = 5 V; V <sub>IN</sub> = 0 V; R <sub>SENSE</sub> = 1 kΩ; T <sub>j</sub> = 25°C	1.985	2.07	2.155	V
		V <sub>SEn</sub> = 5 V; V <sub>SEL0</sub> = 0 V; V <sub>SEL1</sub> = 5 V; V <sub>IN</sub> = 0 V; R <sub>SENSE</sub> = 1 kΩ; T <sub>j</sub> = 125°C	1.435	1.52	1.605	V
dV <sub>SENSE_TC</sub> /dT <sup>(1)</sup>	Temperature coefficient	T <sub>j</sub> = -40°C to 150°C		-5.5		mV/K
Transfer function		V <sub>SENSE_TC</sub> (T) = V <sub>SENSE_TC</sub> (T <sub>0</sub> ) + dV <sub>SENSE_TC</sub> / dT * (T - T <sub>0</sub> )				
V <sub>CC</sub> supply voltage analog feedback (VN7040AJ only)						
V <sub>SENSE_VCC</sub>	MultiSense output voltage proportional to V <sub>CC</sub> supply voltage	V <sub>CC</sub> = 13 V; V <sub>SEn</sub> = 5 V; V <sub>SEL0</sub> = 5 V; V <sub>SEL1</sub> = 5 V; V <sub>IN</sub> = 0 V; R <sub>SENSE</sub> = 1 kΩ	3.16	3.23	3.3	V
Transfer function <sup>(3)</sup>		V <sub>SENSE_VCC</sub> = V <sub>CC</sub> / 4				
Fault diagnostic feedback (see Table 10. Truth table)						
V <sub>SENSEH</sub>	MultiSense output voltage in fault condition	V <sub>CC</sub> = 13 V; V <sub>IN</sub> = 0 V; V <sub>SEn</sub> = 5 V; V <sub>SEL0</sub> = 0 V; V <sub>SEL1</sub> = 0 V; I <sub>OUT</sub> = 0 A; V <sub>OUT</sub> = 4 V; R <sub>SENSE</sub> = 1 kΩ;	5		6.6	V
I <sub>SENSEH</sub>	MultiSense output current in fault condition	V <sub>CC</sub> = 13 V; V <sub>SENSE</sub> = 5 V	7	20	30	mA
MultiSense timings (current sense mode - see Figure 7. MultiSense timings (current sense mode)) <sup>(4)</sup>						
t <sub>DSENSE1H</sub>	Current sense settling time from rising edge of SE <sub>n</sub>	V <sub>IN</sub> = 5 V; V <sub>SEn</sub> = 0 V to 5 V; R <sub>SENSE</sub> = 1 kΩ; R <sub>L</sub> = 5.2 Ω			60	μs
t <sub>DSENSE1L</sub>	Current sense disable delay time from falling edge of SE <sub>n</sub>	V <sub>IN</sub> = 5 V; V <sub>SEn</sub> = 5 V to 0 V; R <sub>SENSE</sub> = 1 kΩ; R <sub>L</sub> = 5.2 Ω		5	20	μs
t <sub>DSENSE2H</sub>	Current sense settling time from rising edge of INPUT	V <sub>IN</sub> = 0 V to 5 V; V <sub>SEn</sub> = 5 V; R <sub>SENSE</sub> = 1 kΩ; R <sub>L</sub> = 5.2 Ω		100	250	μs
Δt <sub>DSENSE2H</sub>	Current sense settling time from rising edge of I <sub>OUT</sub> (dynamic response to a step change of I <sub>OUT</sub> )	V <sub>IN</sub> = 5 V; V <sub>SEn</sub> = 5 V; R <sub>SENSE</sub> = 1 kΩ; I <sub>SENSE</sub> = 90 % of I <sub>SENSEMAX</sub> ; R <sub>L</sub> = 5.2 Ω			100	μs
t <sub>DSENSE2L</sub>	Current sense turn-off delay time from falling edge of INPUT	V <sub>IN</sub> = 5 V to 0 V; V <sub>SEn</sub> = 5 V; R <sub>SENSE</sub> = 1 kΩ; R <sub>L</sub> = 5.2 Ω		50	250	μs
MultiSense timings (chip temperature sense mode - see Figure 8. Multisense timings (chip temperature and V <sub>CC</sub> sense mode) (VN7040AJ only)) <sup>(4)</sup>						
t <sub>DSENSE3H</sub>	V <sub>SENSE_TC</sub> settling time from rising edge of SE <sub>n</sub>	V <sub>SEn</sub> = 0 V to 5 V; V <sub>SEL0</sub> = 0 V; V <sub>SEL1</sub> = 5 V; R <sub>SENSE</sub> = 1 kΩ			60	μs
t <sub>DSENSE3L</sub>	V <sub>SENSE_TC</sub> disable delay time from falling edge of SE <sub>n</sub>	V <sub>SEn</sub> = 5 V to 0 V; V <sub>SEL0</sub> = 0 V; V <sub>SEL1</sub> = 5 V; R <sub>SENSE</sub> = 1 kΩ			20	μs
MultiSense timings (V <sub>CC</sub> voltage sense mode - see Figure 8. Multisense timings (chip temperature and V <sub>CC</sub> sense mode) (VN7040AJ only)) <sup>(4)</sup>						
t <sub>DSENSE4H</sub>	V <sub>SENSE_VCC</sub> settling time from rising edge of SE <sub>n</sub>	V <sub>SEn</sub> = 0 V to 5 V; V <sub>SEL0</sub> = 5 V; V <sub>SEL1</sub> = 5 V; R <sub>SENSE</sub> = 1 kΩ			60	μs
t <sub>DSENSE4L</sub>	V <sub>SENSE_VCC</sub> disable delay time from falling edge of SE <sub>n</sub>	V <sub>SEn</sub> = 5 V to 0 V; V <sub>SEL0</sub> = 5 V; V <sub>SEL1</sub> = 5 V; R <sub>SENSE</sub> = 1 kΩ			20	μs

7 V < V <sub>CC</sub> < 18 V; -40°C < T <sub>j</sub> < 150°C						
Symbol	Parameter	Test conditions	Min.	Typ.	Max.	Unit
MultiSense timings (Multiplexer transition times) (VN7040AJ only) <sup>(4)</sup>						
t <sub>D_CStoTC</sub>	MultiSense transition delay from current sense to T <sub>C</sub> sense	V <sub>IN</sub> = 5 V; V <sub>SEn</sub> = 5 V; V <sub>SEL0</sub> = 0 V; V <sub>SEL1</sub> = 0 V to 5 V; I <sub>OUT</sub> = 1.25 A; R <sub>SENSE</sub> = 1 kΩ			60	μs
t <sub>D_TcToCS</sub>	MultiSense transition delay from T <sub>C</sub> sense to current sense	V <sub>IN</sub> = 5 V; V <sub>SEn</sub> = 5 V; V <sub>SEL0</sub> = 0 V; V <sub>SEL1</sub> = 5 V to 0 V; I <sub>OUT</sub> = 1.25 A; R <sub>SENSE</sub> = 1 kΩ			20	μs
t <sub>D_CStoVCC</sub>	MultiSense transition delay from current sense to V <sub>CC</sub> sense	V <sub>IN</sub> = 5 V; V <sub>SEn</sub> = 5 V; V <sub>SEL0</sub> = 5 V; V <sub>SEL1</sub> = 0 V to 5 V; I <sub>OUT</sub> = 1.25 A; R <sub>SENSE</sub> = 1 kΩ			60	μs
t <sub>D_VCCtoCS</sub>	MultiSense transition delay from V <sub>CC</sub> sense to current sense	V <sub>IN</sub> = 5 V; V <sub>SEn</sub> = 5 V; V <sub>SEL0</sub> = 5 V; V <sub>SEL1</sub> = 5 V to 0 V; I <sub>OUT</sub> = 1.25 A; R <sub>SENSE</sub> = 1 kΩ			20	μs
t <sub>D_TcToVCC</sub>	MultiSense transition delay from T <sub>C</sub> sense to V <sub>CC</sub> sense	V <sub>CC</sub> = 13 V; T <sub>j</sub> = 125°C; V <sub>SEn</sub> = 5 V; V <sub>SEL0</sub> = 0 V to 5 V; V <sub>SEL1</sub> = 5 V; R <sub>SENSE</sub> = 1 kΩ			20	μs
t <sub>D_VCCtoTC</sub>	MultiSense transition delay from V <sub>CC</sub> sense to T <sub>C</sub> sense	V <sub>CC</sub> = 13 V; T <sub>j</sub> = 125°C; V <sub>SEn</sub> = 5 V; V <sub>SEL0</sub> = 5 V to 0 V; V <sub>SEL1</sub> = 5 V; R <sub>SENSE</sub> = 1 kΩ			20	μs

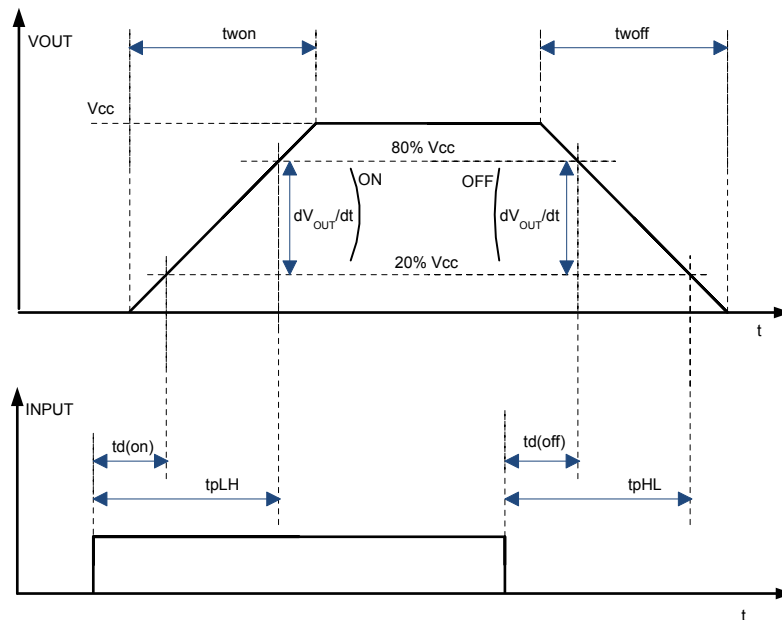
1. Parameter specified by design; not subjected to production test.
2. All values refer to V<sub>CC</sub> = 13 V; T<sub>j</sub> = 25°C, unless otherwise specified.
3. V<sub>CC</sub> sensing and T<sub>C</sub> are referred to GND potential.
4. Transition delays are measured up to +/- 10% of final conditions.

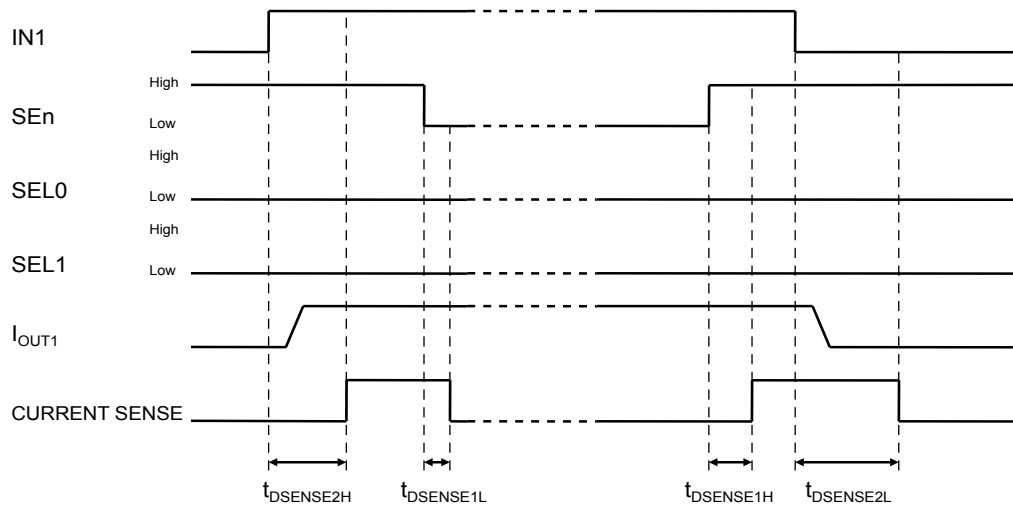
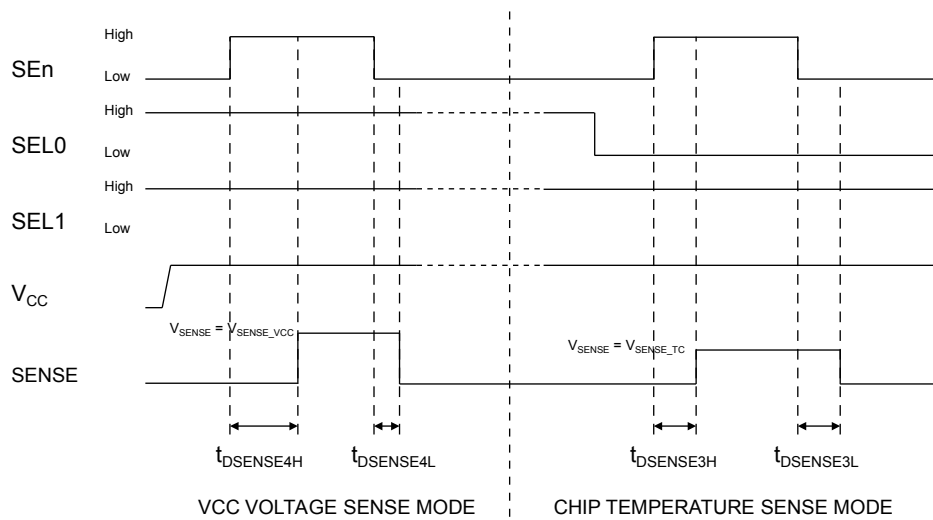
**Figure 4. I<sub>OUT</sub>/I<sub>SENSE</sub> versus I<sub>OUT</sub>**


GAPGCF01210

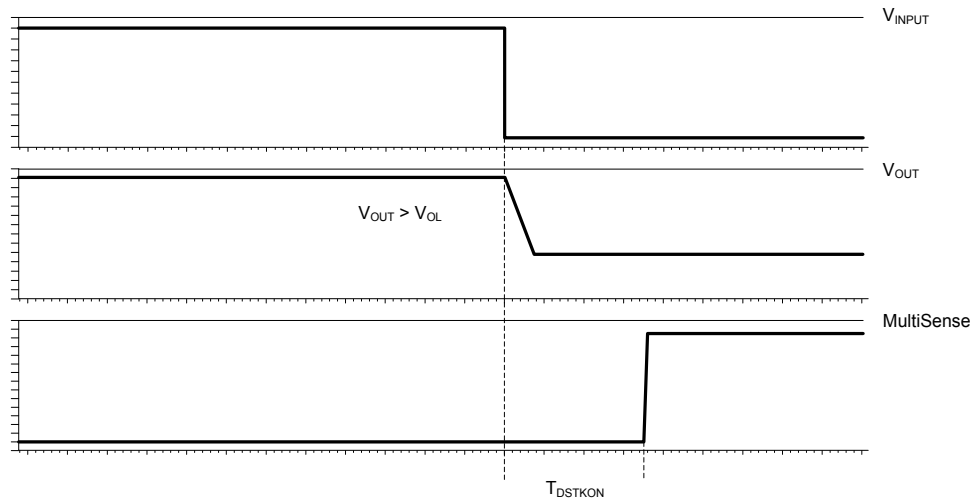
**Figure 5. Current sense accuracy versus  $I_{OUT}$** 


GAPGCF01211

**Figure 6. Switching time and Pulse skew**


**Figure 7. MultiSense timings (current sense mode)**

**Figure 8. Multisense timings (chip temperature and V<sub>CC</sub> sense mode) (VN7040AJ only)**


GAPGCT00319

**Figure 9. T<sub>DSTKON</sub>**


GAPG2609141140CFT

**Table 10. Truth table**

Mode	Conditions	IN <sub>x</sub>	FR <sup>(1)</sup>	SEn	SEL <sub>x</sub> <sup>(1)</sup>	OUT <sub>x</sub>	MultiSense	Comments
Standby	All logic inputs low	L	L	L	L	L	Hi-Z	Low quiescent current consumption
Normal	Nominal load connected; T <sub>j</sub> < 150 °C	L	X	See <sup>(2)</sup>		L	See <sup>(2)</sup>	
		H	L			H	See <sup>(2)</sup>	Outputs configured for auto-restart
		H	H			H	See <sup>(2)</sup>	Outputs configured for latch-off <sup>(1)</sup>
Overload	Overload or short to GND causing: T <sub>j</sub> > T <sub>TSD</sub> or ΔT <sub>j</sub> > ΔT <sub>j_SD</sub>	L	X	See <sup>(2)</sup>		L	See <sup>(2)</sup>	
		H	L			H	See <sup>(2)</sup>	Output cycles with temperature hysteresis
		H	H			L	See <sup>(2)</sup>	Output latches-off <sup>(1)</sup>
Undervoltage	V <sub>CC</sub> < V <sub>USD</sub> (falling)	X	X	X	X	L	Hi-Z	Re-start when V <sub>CC</sub> > V <sub>USD</sub> + V <sub>USDhyst</sub> (rising)
		L	L	L	L	L	Hi-Z	
OFF-state diagnostics	Short to V <sub>CC</sub>	L	X	See <sup>(2)</sup>		H	See <sup>(2)</sup>	
	Open-load	L	X			H	See <sup>(2)</sup>	External pull-up
Negative output voltage	Inductive loads turn-off	L	X	See <sup>(2)</sup>		< 0 V	See <sup>(2)</sup>	

1. VN7040AJ only

2. Refer to Table 11. MultiSense multiplexer addressing

**Table 11. MultiSense multiplexer addressing**

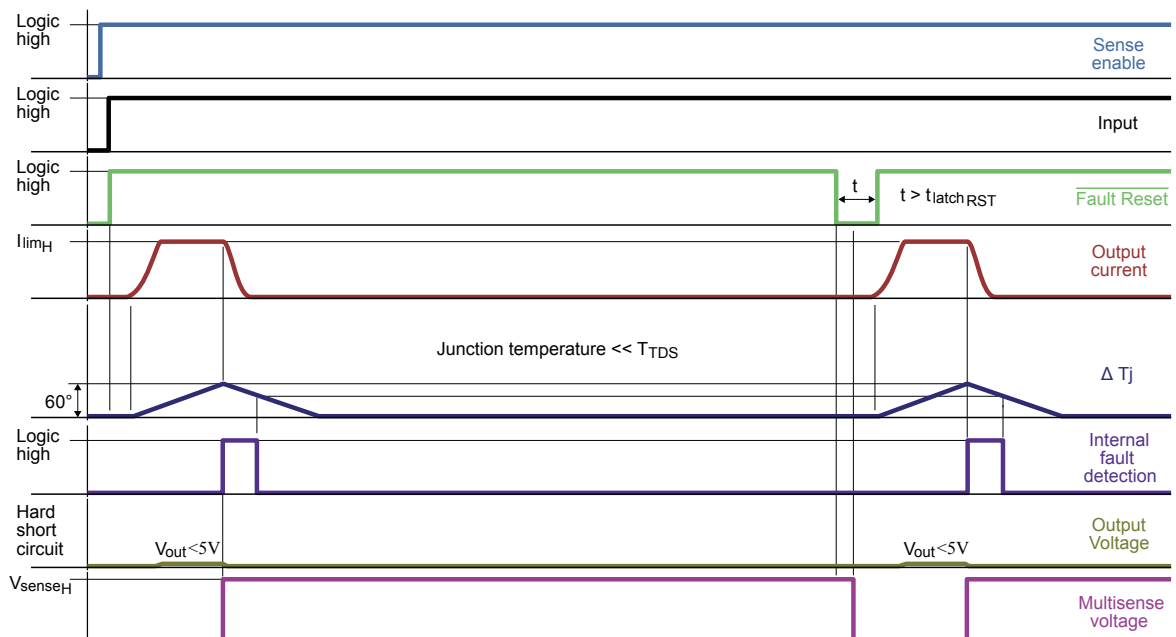
SEn	SEL <sub>1</sub>	SEL <sub>0</sub>	MUX channel	MultiSense output			
				Normal mode	Overload	OFF-state diag. <sup>(1)</sup>	Negative output
SO-8							

SEn	SEL <sub>1</sub>	SEL <sub>0</sub>	MUX channel	MultiSense output			
				Normal mode	Overload	OFF-state diag. <sup>(1)</sup>	Negative output
L	N.A.	N.A.	N.A.	Hi-Z			
H	N.A.	N.A.	Channel diagnostic	$I_{SENSE} = 1/K * I_{OUT}$	$V_{SENSE} = V_{SENSEH}$	$V_{SENSE} = V_{SENSEH}$	Hi-Z
PowerSSO-16							
H	L	L	Channel diagnostic	$I_{SENSE} = 1/K * I_{OUT}$	$V_{SENSE} = V_{SENSEH}$	$V_{SENSE} = V_{SENSEH}$	Hi-Z
H	L	H	Channel diagnostic	$I_{SENSE} = 1/K * I_{OUT}$	$V_{SENSE} = V_{SENSEH}$	$V_{SENSE} = V_{SENSEH}$	Hi-Z
H	H	L	T <sub>CHIP</sub> Sense	$V_{SENSE} = V_{SENSE\_TC}$			
H	H	H	V <sub>CC</sub> Sense	$V_{SENSE} = V_{SENSE\_VCC}$			

1. In case the output channel corresponding to the selected MUX channel is latched off while the relevant input is low, Multisense pin delivers feedback according to OFF-State diagnostic. Example 1: FR = 1; IN = 0; OUT = L (latched); MUX channel = channel 0 diagnostic; Mutisense = 0. Example 2: FR = 1; IN = 0; OUT = latched,  $V_{OUT} > V_{OL}$ ; MUX channel = channel 0 diagnostic; Mutisense =  $V_{SENSEH}$

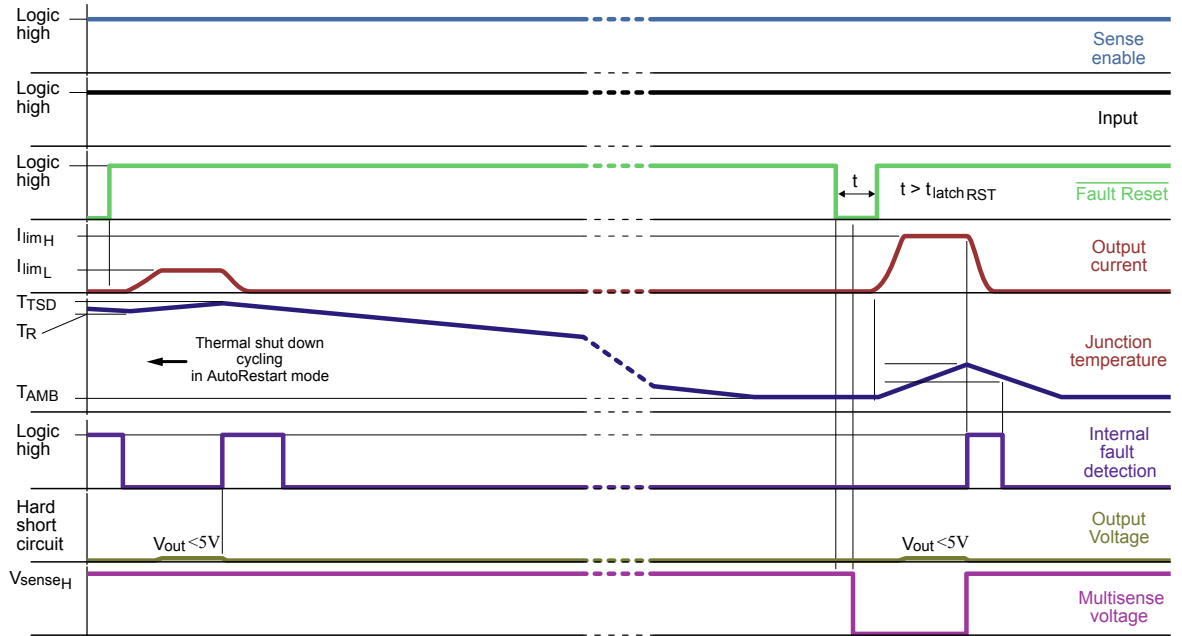
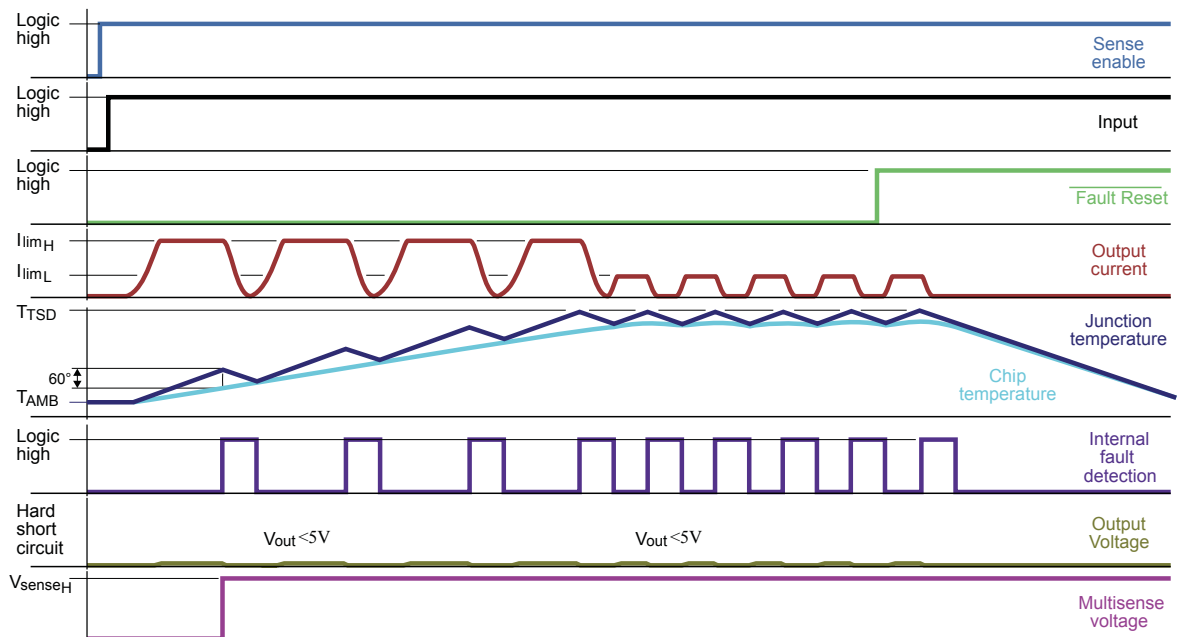
## 2.4 Waveforms

**Figure 10. Latch functionality - behavior in hard short-circuit condition ( $T_{AMB} \ll T_{TDS}$ )**

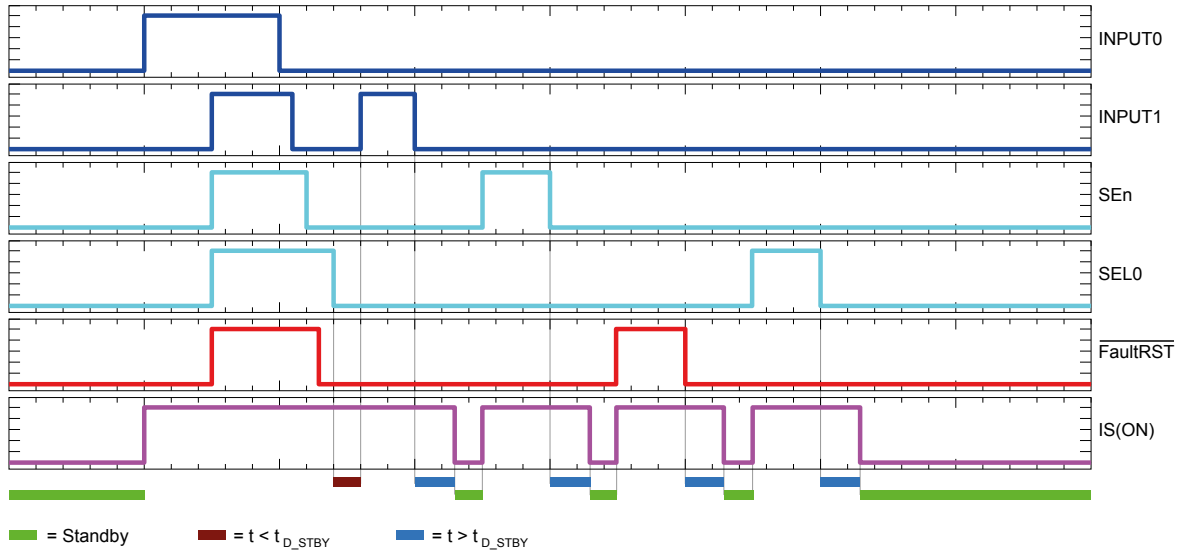


GADG1703171451PS

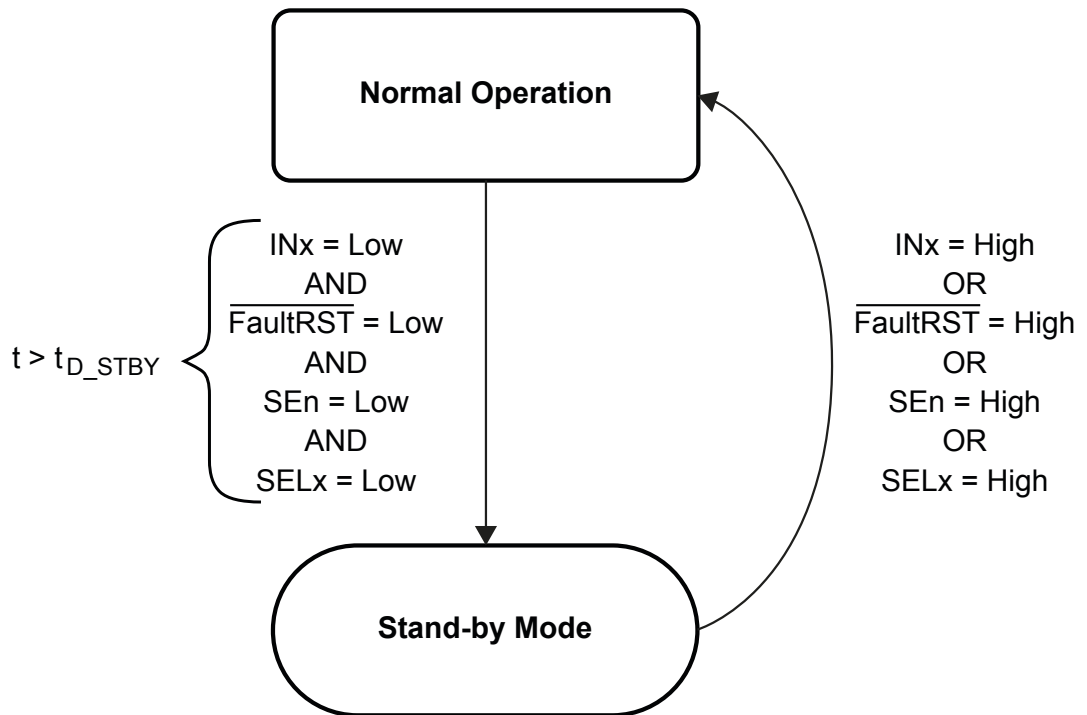


**Figure 11. Latch functionality - behavior in hard short-circuit condition**

**Figure 12. Latch functionality - behavior in hard short-circuit condition (autorestart mode + latch off)**


GADG2103171742PS

**Figure 13. Standby mode activation**


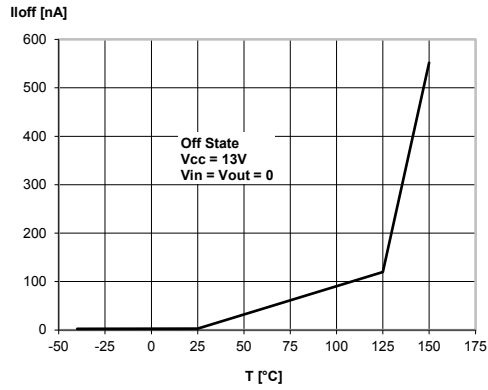
GADG1703171116PS

**Figure 14. Standby state diagram**


GAPGCFT00598

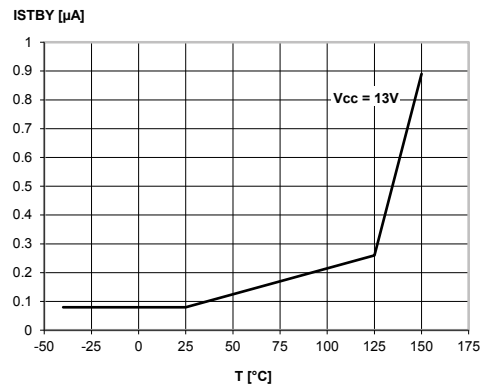
## 2.5 Electrical characteristics curves

Figure 15. OFF-state output current



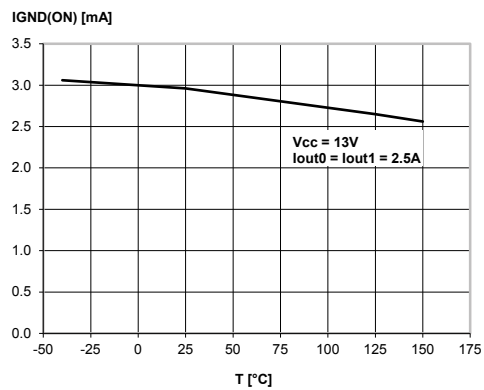
GAPGCFT01190

Figure 16. Standby current



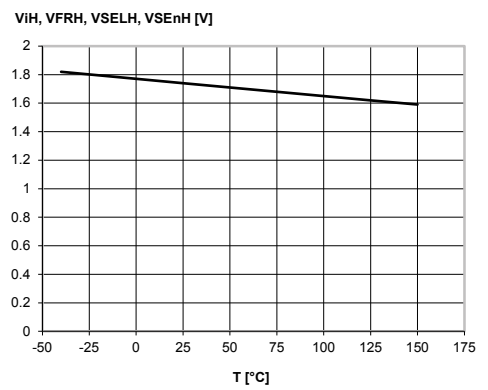
GAPGCFT01191

Figure 17.  $I_{GND(ON)}$  vs.  $T_{case}$



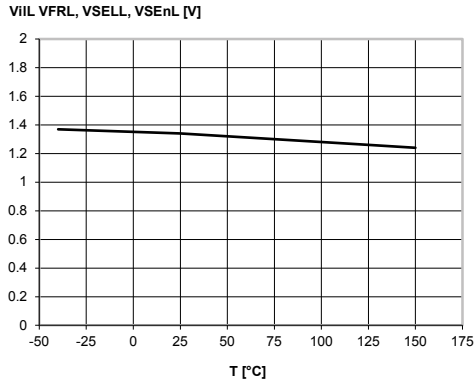
GAPGCFT01192

Figure 18. Logic Input high level voltage



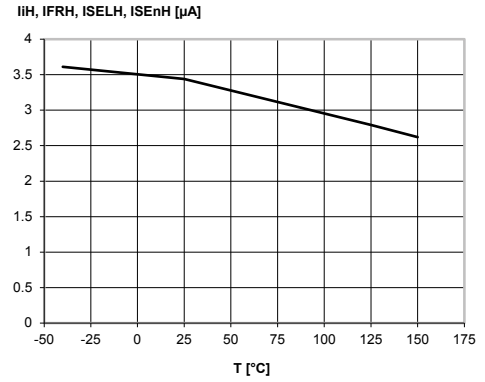
GAPGCFT01193

Figure 19. Logic Input low level voltage



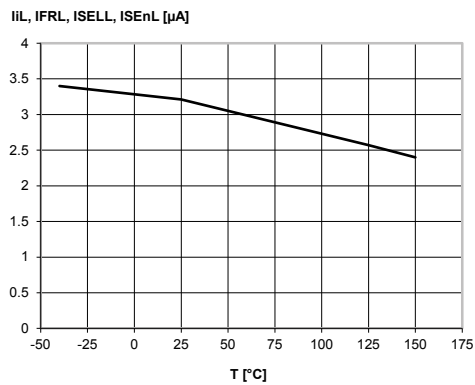
GAPGCFT01194

Figure 20. High level logic input current



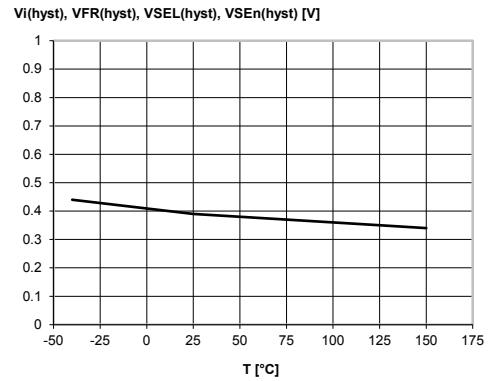
GAPGCFT01195

Figure 21. Low level logic input current



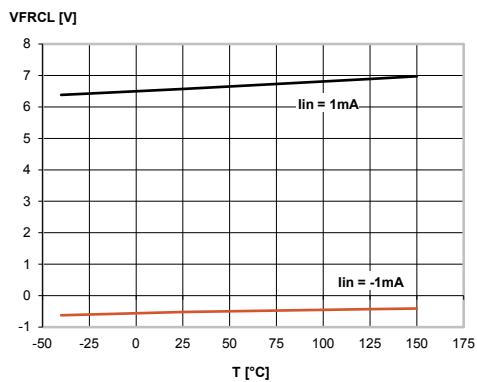
GAPGCFT01196

Figure 22. Logic Input hysteresis voltage



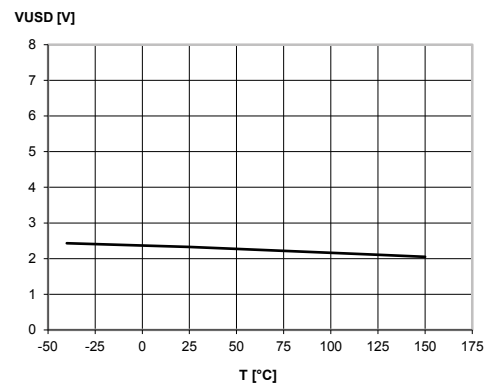
GAPGCFT01197

Figure 23. FaultRST Input clamp voltage

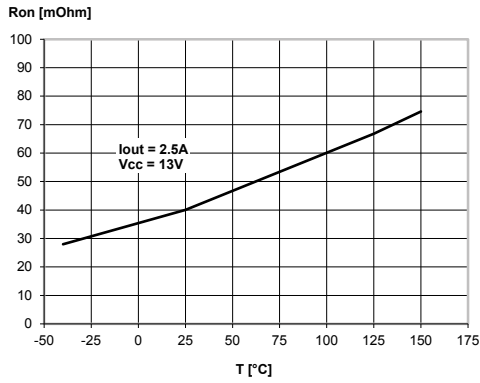


GAPGCFT01198

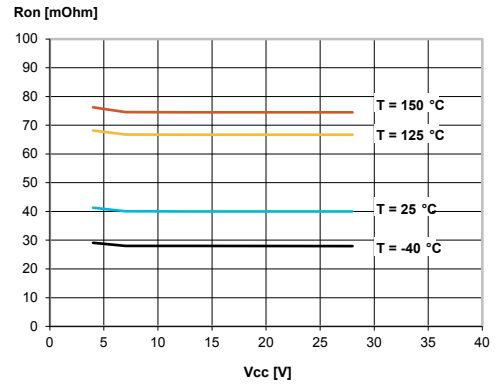
Figure 24. Undervoltage shutdown



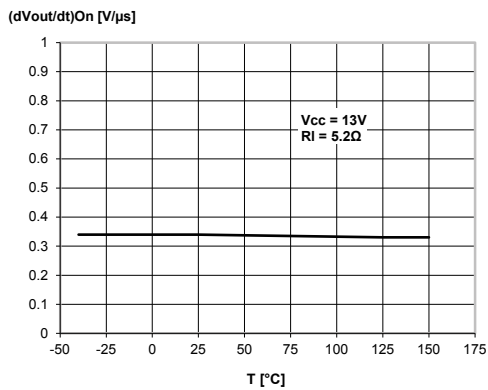
GAPGCFT01199

**Figure 25. On-state resistance vs.  $T_{case}$** 


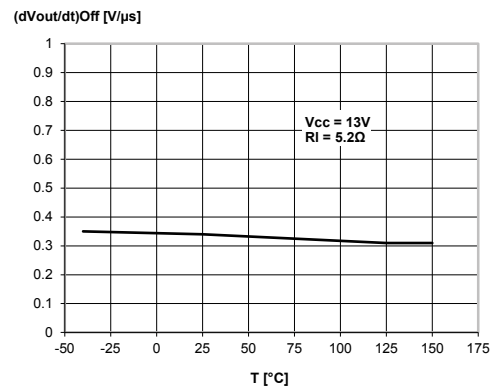
GAPGCFT01200

**Figure 26. On-state resistance vs.  $V_{CC}$** 


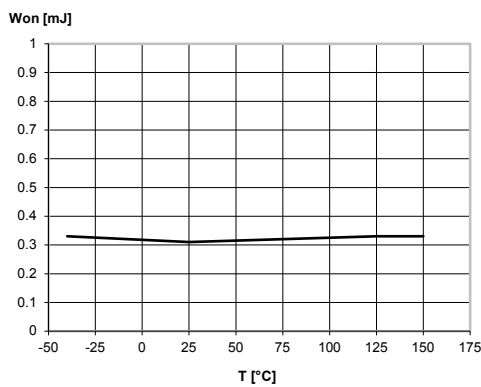
GAPGCFT01201

**Figure 27. Turn-on voltage slope**


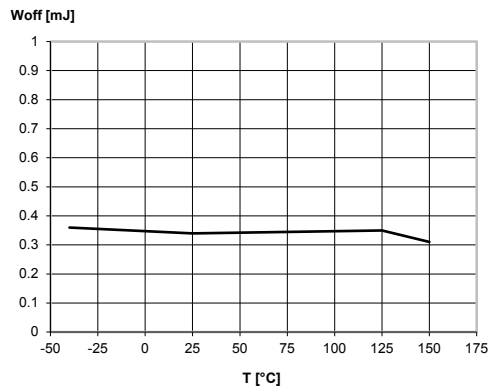
GAPGCFT01202

**Figure 28. Turn-off voltage slope**


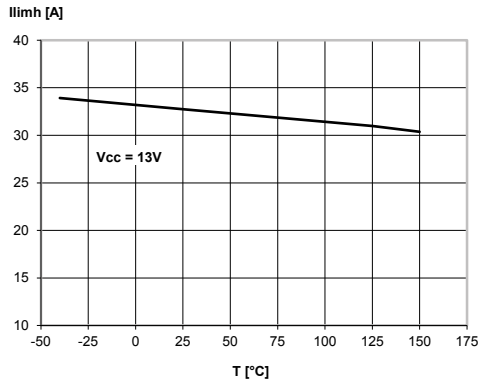
GAPGCFT01203

**Figure 29.  $W_{on}$  vs.  $T_{case}$** 


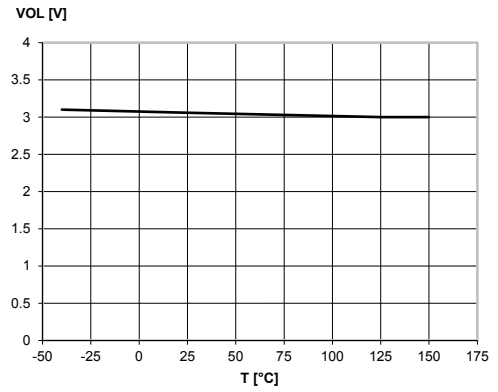
GAPGCFT01204

**Figure 30.  $W_{off}$  vs.  $T_{case}$** 


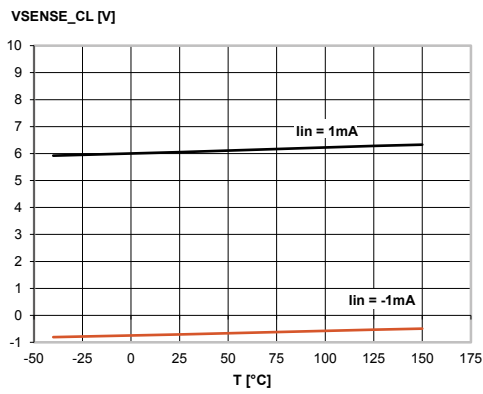
GAPGCFT01205

**Figure 31.  $I_{LIMH}$  vs.  $T_{case}$** 


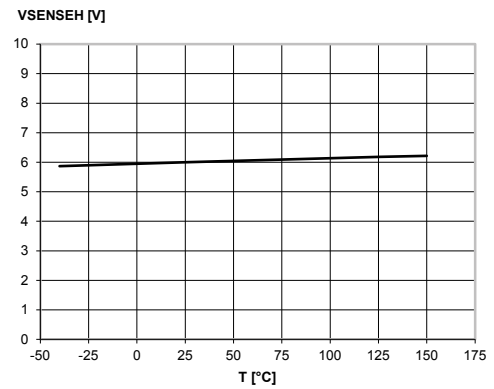
GAPGCFT01206

**Figure 32. OFF-state open-load voltage detection threshold**


GAPGCFT01207

**Figure 33.  $V_{sense\ clamp}$  vs.  $T_{case}$** 


GAPGCFT01208

**Figure 34.  $V_{senseh}$  vs.  $T_{case}$** 


GAPGCFT01209

## 3 Protections

### 3.1 Power limitation

The basic working principle of this protection consists of an indirect measurement of the junction temperature swing  $\Delta T_j$  through the direct measurement of the spatial temperature gradient on the device surface in order to automatically shut off the output MOSFET as soon as  $\Delta T_j$  exceeds the safety level of  $\Delta T_{j\_SD}$ . According to the voltage level on the  $\overline{\text{FaultRST}}$  pin, the output MOSFET switches on and cycles with a thermal hysteresis according to the maximum instantaneous power which can be handled ( $\overline{\text{FaultRST}} = \text{Low}$ ) or remains off ( $\overline{\text{FaultRST}} = \text{High}$ ). The protection prevents fast thermal transient effects and, consequently, reduces thermo-mechanical fatigue.

### 3.2 Thermal shutdown

In case the junction temperature of the device exceeds the maximum allowed threshold (typically 175°C), it automatically switches off and the diagnostic indication is triggered. According to the voltage level on the  $\overline{\text{FaultRST}}$  pin, the device switches on again as soon as its junction temperature drops to  $T_R$  ( $\overline{\text{FaultRST}} = \text{Low}$ ) or remains off ( $\overline{\text{FaultRST}} = \text{High}$ ).

### 3.3 Current limitation

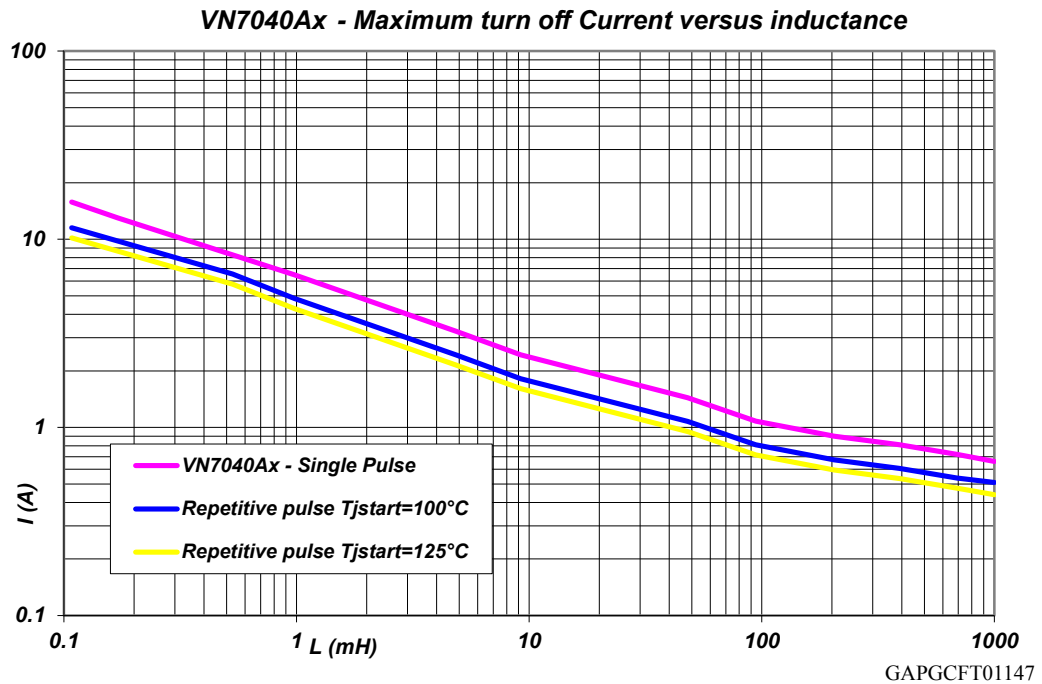
The device is equipped with an output current limiter in order to protect the silicon as well as the other components of the system (e.g. bonding wires, wiring harness, connectors, loads, etc.) from excessive current flow. Consequently, in case of short circuit, overload or during load power-up, the output current is clamped to a safety level,  $I_{LIMH}$ , by operating the output power MOSFET in the active region.

### 3.4 Negative voltage clamp

In case the device drives inductive load, the output voltage reaches a negative value during turn off. A negative voltage clamp structure limits the maximum negative voltage to a certain value,  $V_{DEMG}$ , allowing the inductor energy to be dissipated without damaging the device.

## 4 Maximum demagnetization energy (VCC = 16 V)

Figure 35. Maximum turn off current versus inductance



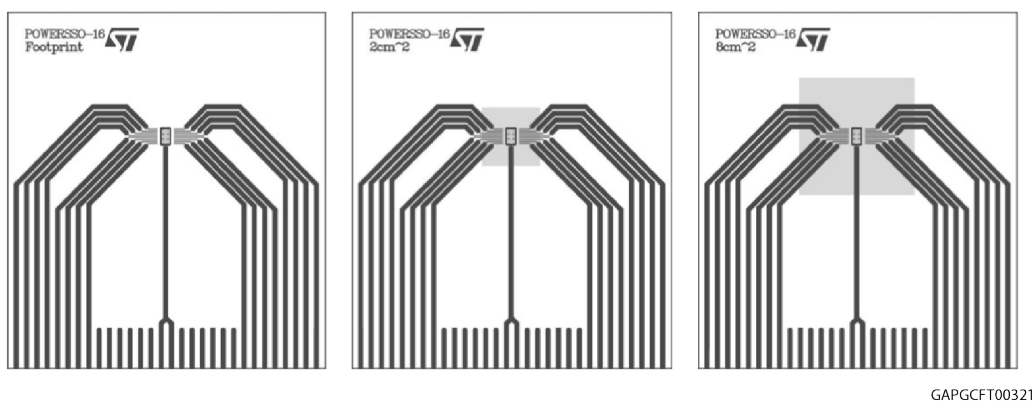
Note: Values are generated with  $R_L = 0 \Omega$ .  
In case of repetitive pulses,  $T_{jstart}$  (at the beginning of each demagnetization) of every pulse must not exceed the temperature specified above for curves A and B.



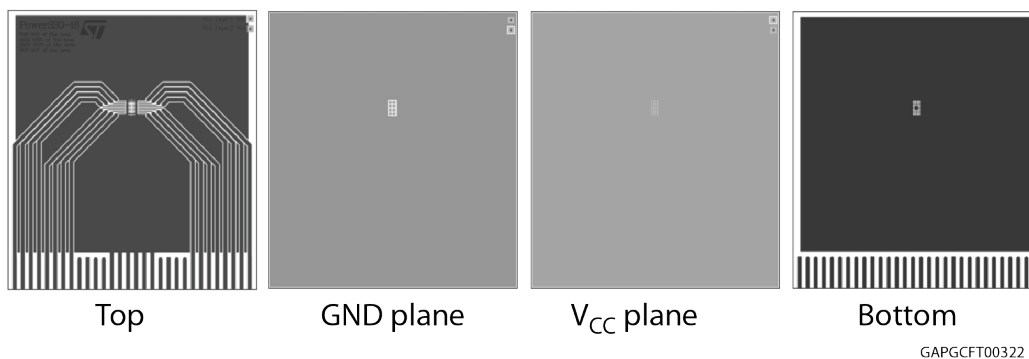
## 5 Package and PCB thermal data

### 5.1 PowerSSO-16 thermal data

**Figure 36. PowerSSO-16 on two-layers PCB (2s0p to JEDEC JESD 51-5)**



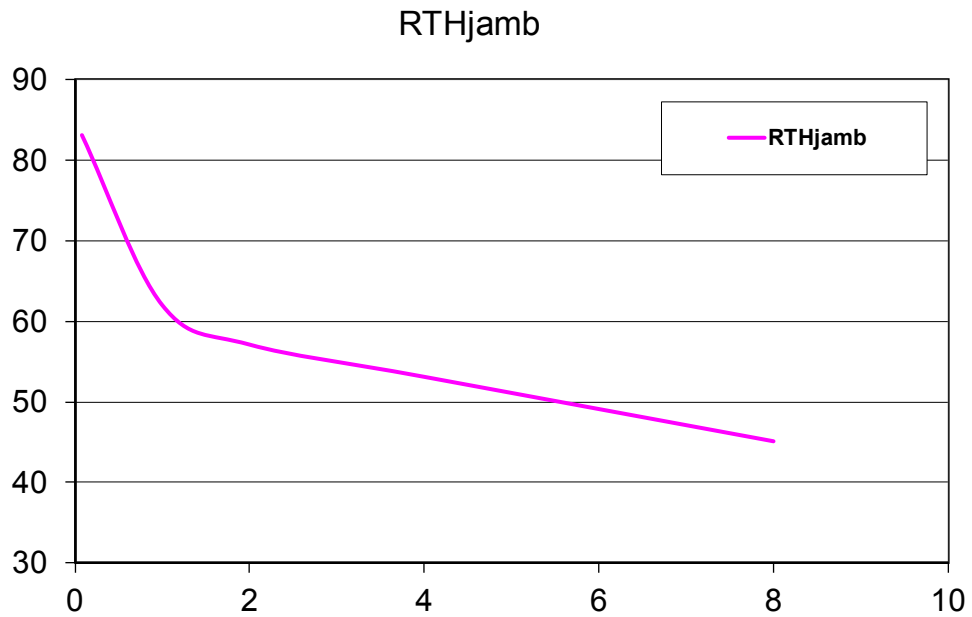
**Figure 37. PowerSSO-16 on four-layers PCB (2s2p to JEDEC JESD 51-7)**



**Table 12. PCB properties**

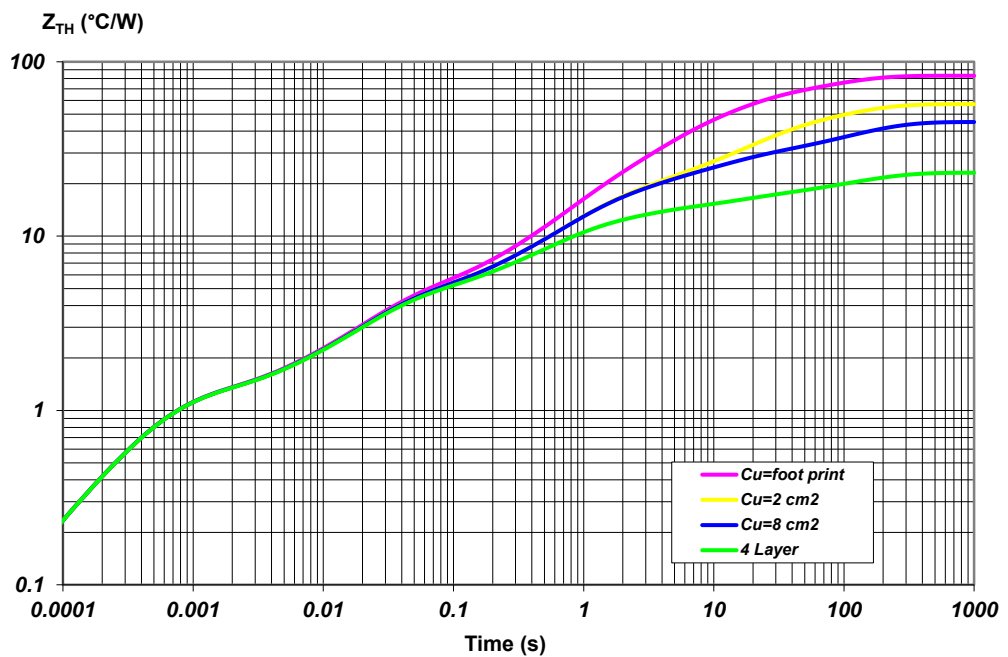
Dimension	Value
Board finish thickness	1.6 mm +/- 10%
Board dimension	77 mm x 86 mm
Board Material	FR4
Copper thickness (top and bottom layers)	0.070 mm
Copper thickness (inner layers)	0.035 mm
Thermal vias separation	1.2 mm
Thermal via diameter	0.3 mm +/- 0.08 mm
Copper thickness on vias	0.025 mm
Footprint dimension (top layer)	2.2 mm x 3.9 mm

Dimension	Value
Heatsink copper area dimension (bottom layer)	Footprint, 2 cm <sup>2</sup> or 8 cm <sup>2</sup>

**Figure 38. PowerSSO-16  $R_{thj-amb}$  vs PCB copper area in open box free air condition (one channel on)**


RTHj\_amb on 4Layer PCB: 23.5°C/W

GAPGCFT01141

**Figure 39. PowerSSO-16 thermal impedance junction ambient single pulse (one channel on)**


GAPGCFT01142

**Equation: pulse calculation formula**

$$Z_{TH\delta} = R_{TH} \cdot \delta + Z_{THtp} (1 - \delta)$$

 where  $\delta = t_p/T$ 
**Figure 40. Thermal fitting model of a double-channel HSD in PowerSSO-16**


TAPG2001151031CFT

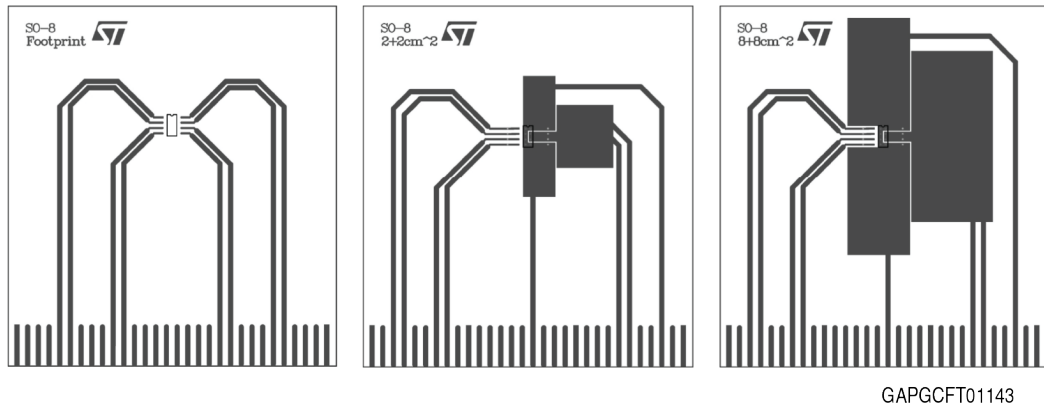
*Note:* The fitting model is a simplified thermal tool and is valid for transient evolutions where the embedded protections (power limitation or thermal cycling during thermal shutdown) are not triggered.

**Table 13. Thermal parameters**

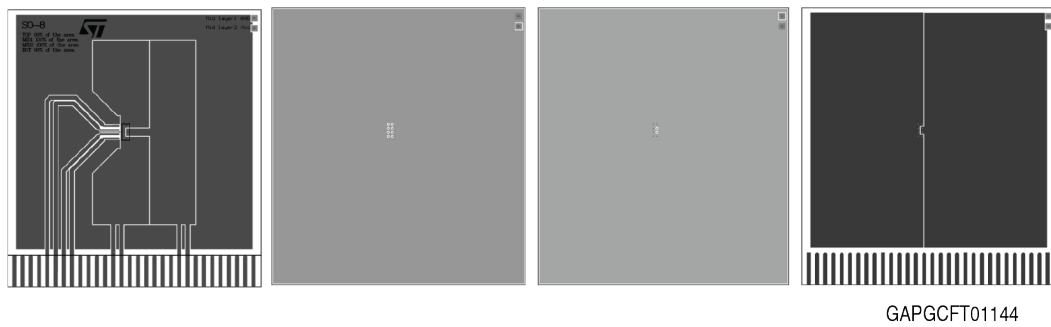
Area/island (cm <sup>2</sup> )	Footprint	2	8	4L
R1 (°C/W)	1.1			
R2 (°C/W)	3			
R3 (°C/W)	7	7	7	5
R4 (°C/W)	16	6	6	4
R5 (°C/W)	30	20	10	3
R6 (°C/W)	26	20	18	7
C1 (W.s/°C)	0.0004			
C2 (W.s/°C)	0.008			
C3 (W.s/°C)	0.1			
C4 (W.s/°C)	0.2	0.3	0.3	0.4
C5 (W.s/°C)	0.4	1	1	4
C6 (W.s/°C)	3	5	7	18

## 5.2 SO-8 thermal data

**Figure 41. SO-8 on two-layers PCB (2s0p to JEDEC JESD 51-5)**

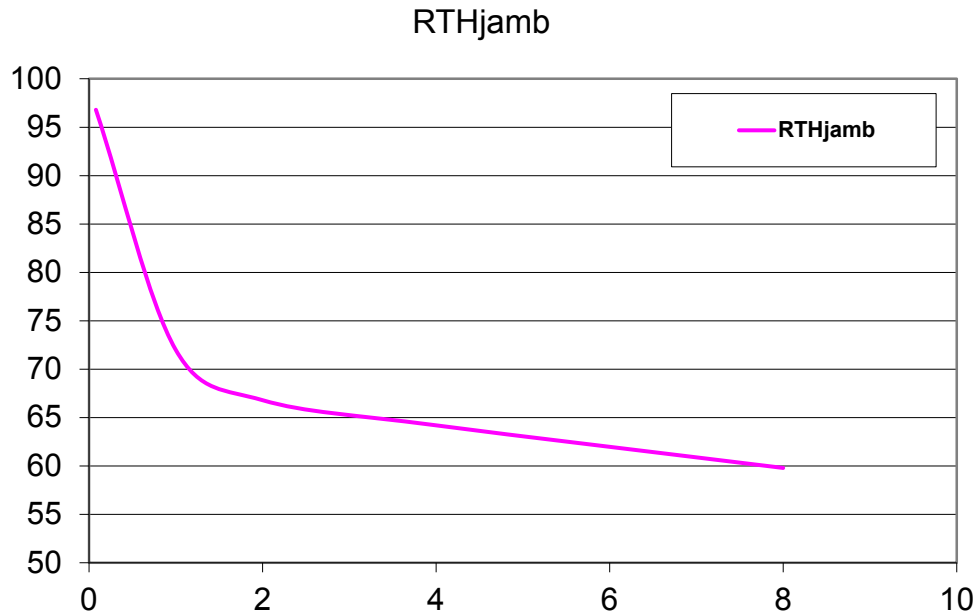


**Figure 42. SO-8 on four-layers PCB (2s2p to JEDEC JESD 51-7)**



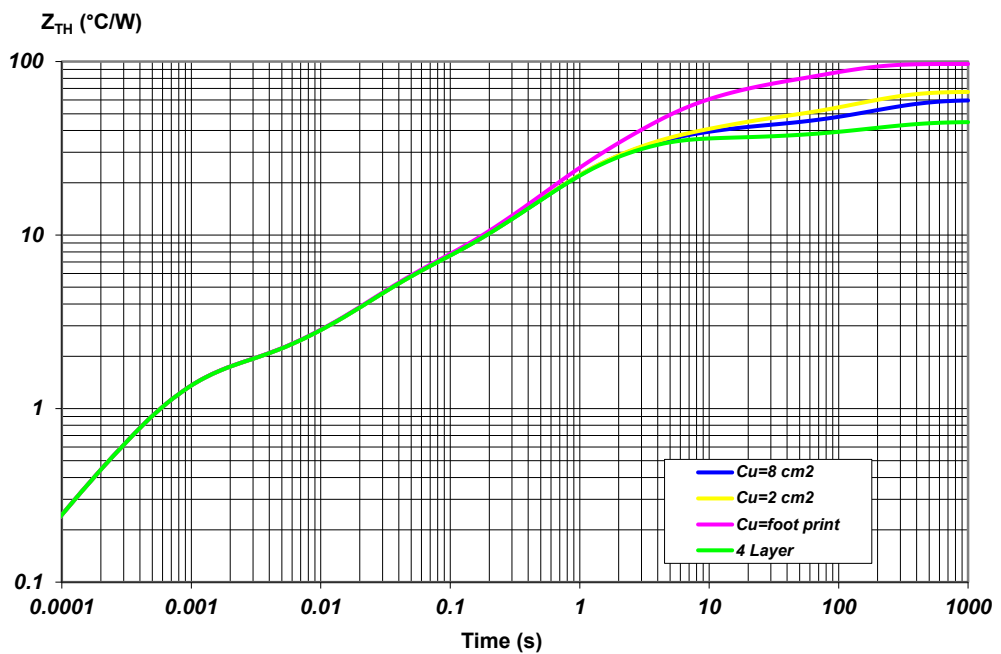
**Table 14. PCB properties**

Dimension	Value
Board finish thickness	1.6 mm +/- 10%
Board dimension	77 mm x 86 mm
Board Material	FR4
Copper thickness (top and bottom layers)	0.070 mm
Copper thickness (inner layers)	0.035 mm
Thermal via separation	1.2 mm
Thermal via diameter	0.3 mm +/- 0.08 mm
Copper thickness on vias	0.025 mm
Heatsink copper area dimension (bottom layer)	Footprint, 2 + 2 cm <sup>2</sup> or 8 + 8 cm <sup>2</sup>

**Figure 43. SO-8  $R_{thj-amb}$  vs PCB copper area in open box free air condition (one channel on)**


RTHj\_amb on 4Layer PCB: 45°C/W

GAPGCFT01145

**Figure 44. SO-8 thermal impedance junction ambient single pulse (one channel on)**


GAPGCFT01146

**Equation: pulse calculation formula**

$$Z_{TH\delta} = R_{TH} \cdot \delta + Z_{THtp} (1 - \delta)$$

 where  $\delta = t_p/T$

**Figure 45. Thermal fitting model of a double-channel HSD in SO-8**


TAPG2001151031CFT

**Note:** The fitting model is a simplified thermal tool and is valid for transient evolutions where the embedded protections (power limitation or thermal cycling during thermal shutdown) are not triggered.

**Table 15. Thermal parameters**

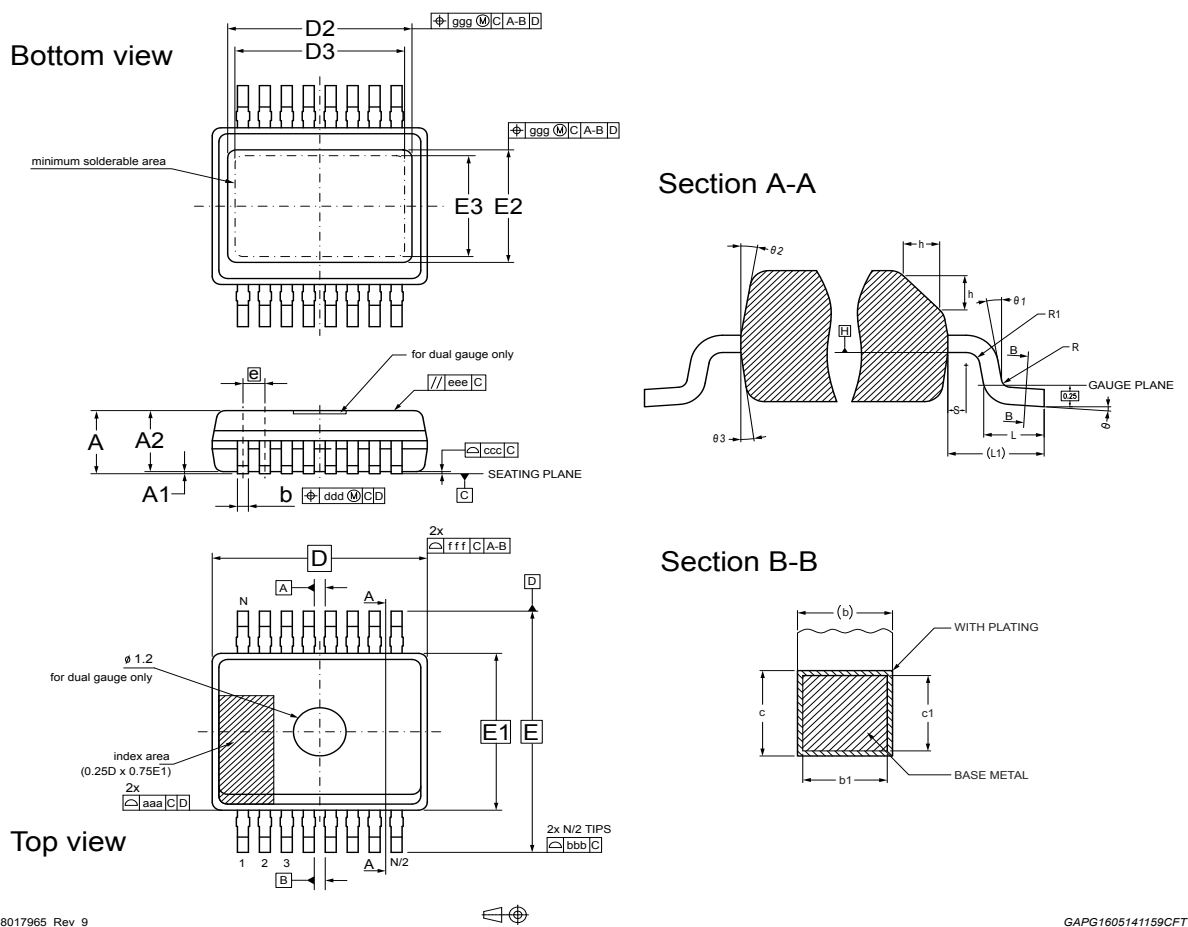
Area/island (cm <sup>2</sup> )	Footprint	2	8	4L
R1 (°C/W)	1.5			
R2 (°C/W)	3.3			
R3 (°C/W)	10			
R4 (°C/W)	28	17	17	17
R5 (°C/W)	24	12	9	4
R6 (°C/W)	30	23	19	9
C1 (W.s/°C)	0.0004			
C2 (W.s/°C)	0.008			
C3 (W.s/°C)	0.05			
C4 (W.s/°C)	0.1			
C5 (W.s/°C)	0.4	0.8	0.8	0.8
C6 (W.s/°C)	3	7	11	22

## 6 Package information

In order to meet environmental requirements, ST offers these devices in different grades of **ECOPACK** packages, depending on their level of environmental compliance. ECOPACK specifications, grade definitions and product status are available at: [www.st.com](http://www.st.com). ECOPACK is an ST trademark.

### 6.1 PowerSSO-16 package information

**Figure 46. PowerSSO-16 package outline**

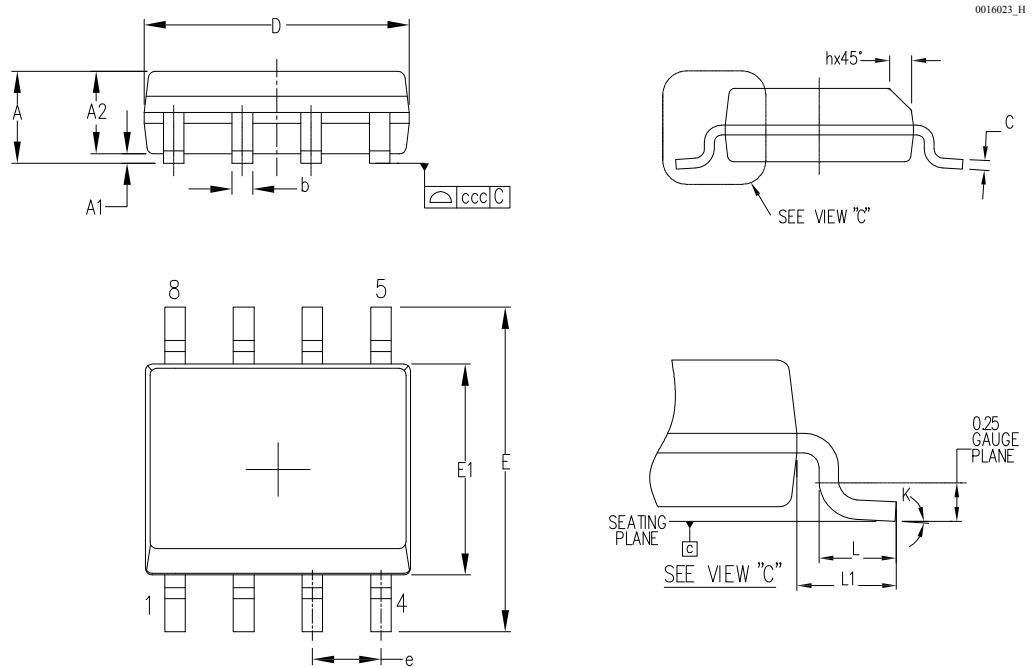


**Table 16. PowerSSO-16 mechanical data**

Symbol	Millimeters		
	Min.	Typ.	Max.
Θ	0°		8°
Θ1	0°		
Θ2	5°		15°
Θ3	5°		15°
A			1.70
A1	0.00		0.10
A2	1.10		1.60
b	0.20		0.30
b1	0.20	0.25	0.28
c	0.19		0.25
c1	0.19	0.20	0.23
D	4.9 BSC		
D2	2.90		3.50
D3	2.20		
e	0.50 BSC		
E	6.00 BSC		
E1	3.90 BSC		
E2	2.20		2.80
E3	1.50		
h	0.25		0.50
L	0.40	0.60	0.85
L1	1.00 REF		
N	16		
R	0.07		
R1	0.07		
S	0.20		
Tolerance of form and position			
aaa	0.10		
bbb	0.10		
ccc	0.08		
ddd	0.08		
eee	0.10		
fff	0.10		
ggg	0.15		



## 6.2 SO-8 package information

**Figure 47. SO-8 package outline**


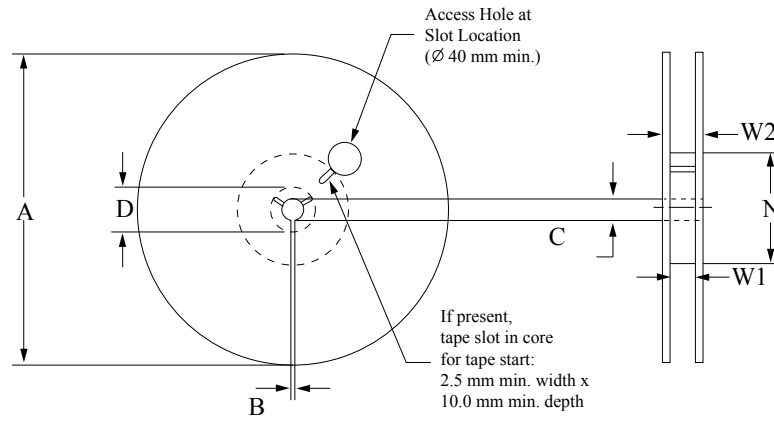
GAPG1605141113CFT

**Table 17. SO-8 mechanical data**

Ref.	Dimensions		
	Millimeters		
	Min.	Typ.	Max.
A			1.75
A1	0.10		0.25
A2	1.25		
b	0.28		0.48
c	0.17		0.23
D	4.80	4.90	5.00
E	5.80	6.00	6.20
E1	3.80	3.90	4.00
e		1.27	
h	0.25		0.50
L	0.40		1.27
L1		1.04	
k	0°		8°
ccc			0.10

### 6.3 PowerSSO-16 packing information

Figure 48. PowerSSO-16 reel 13"



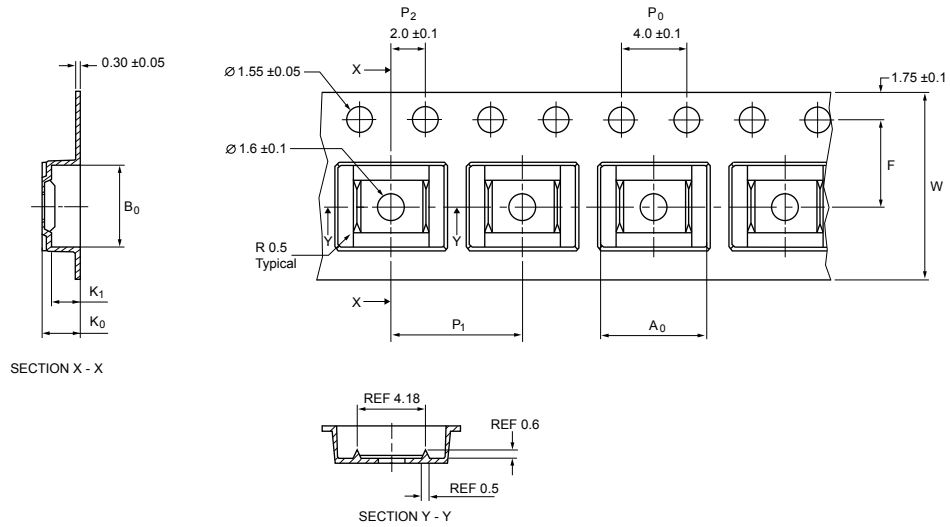
TAPG2004151655CFT

Table 18. Reel dimensions

Description	Value <sup>(1)</sup>
Base quantity	2500
Bulk quantity	2500
A (max)	330
B (min)	1.5
C (+0.5, -0.2)	13
D (min)	20.2
N	100
W1 (+2 /-0)	12.4
W2 (max)	18.4

1. All dimensions are in mm.

Figure 49. PowerSSO-16 carrier tape



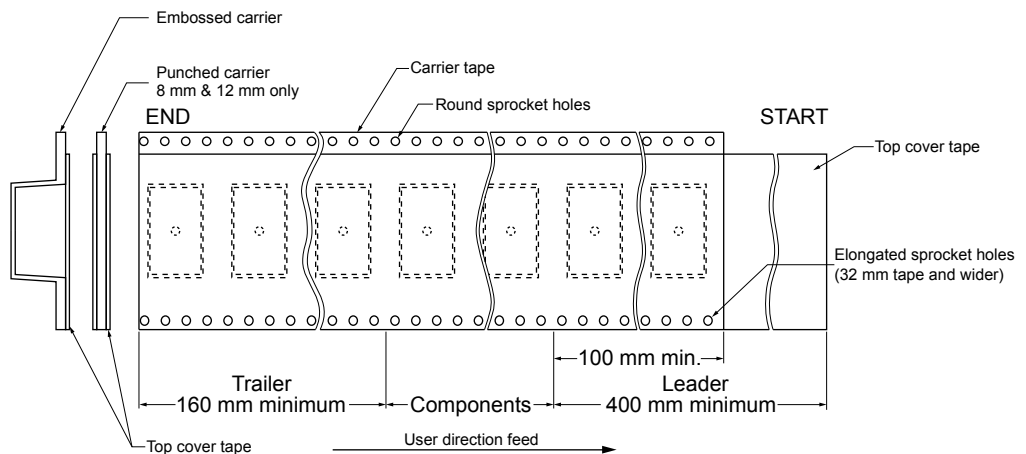
GAPG2204151242CFT

Table 19. PowerSSO-16 carrier tape dimensions

Description	Value <sup>(1)</sup>
$A_0$	$6.50 \pm 0.1$
$B_0$	$5.25 \pm 0.1$
$K_0$	$2.10 \pm 0.1$
$K_1$	$1.80 \pm 0.1$
$F$	$5.50 \pm 0.1$
$P_1$	$8.00 \pm 0.1$
$W$	$12.00 \pm 0.3$

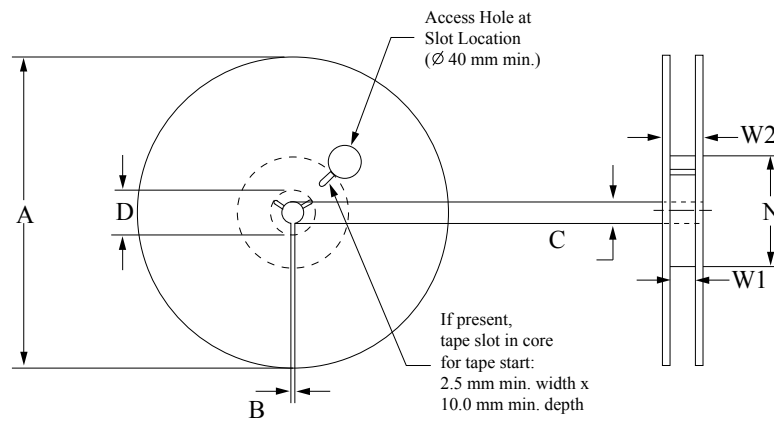
1. All dimensions are in mm.

Figure 50. PowerSSO-16 schematic drawing of leader and trailer tape



GAPG2004151511CFT

## 6.4 SO-8 packing information

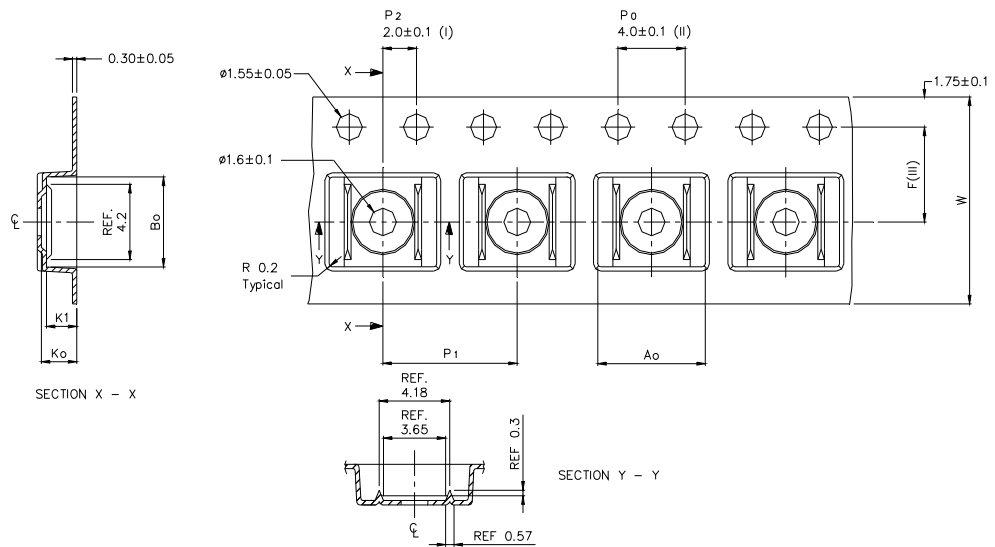
**Figure 51. Reel for SO-8**


TAPG2004151655CFT

**Table 20. Reel dimensions**

Description	Value <sup>(1)</sup>
Base quantity	2500
Bulk quantity	2500
A (max)	330
B (min)	1.5
C (+0.5, -0.2)	13
D (min)	20.2
N	100
W1 (+2/ -0)	12.4
W2 (max)	18.4

1. All dimensions are in mm.

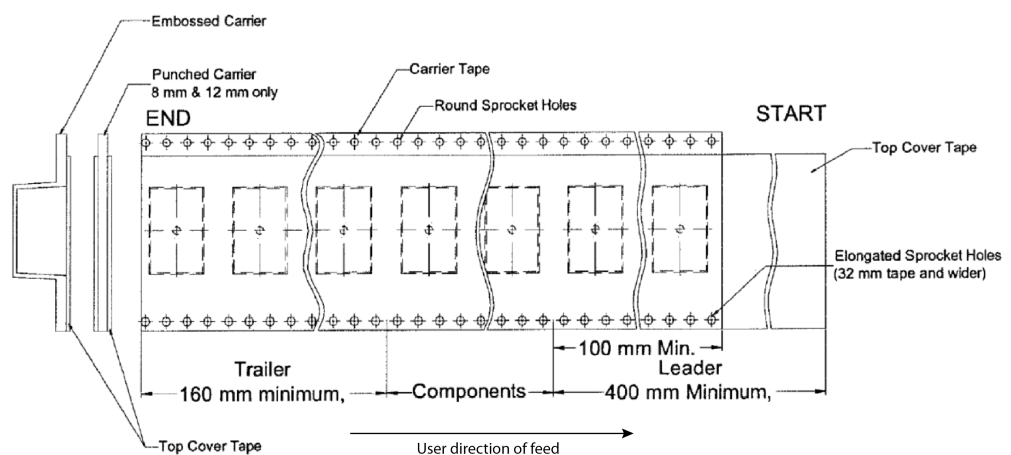
**Figure 52. SO-8 carrier tape**


GAPG2105151447CFT

**Table 21. SO-8 carrier tape dimensions**

Description	Value <sup>(1)</sup>
A <sub>0</sub>	6.50 ± 0.1
B <sub>0</sub>	5.30 ± 0.1
K <sub>0</sub>	2.20 ± 0.1
K <sub>1</sub>	1.90 ± 0.1
F	5.50 ± 0.1
P <sub>1</sub>	8.00 ± 0.1
W	12.00 ± 0.3

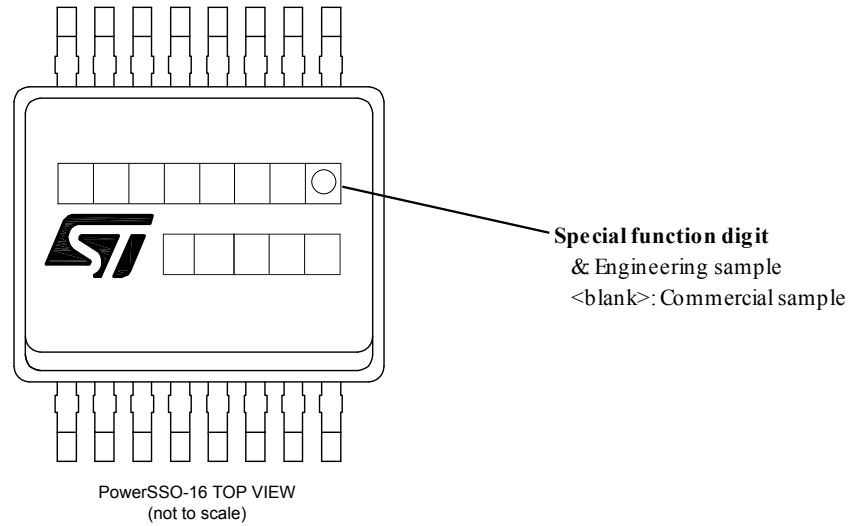
1. All dimensions are in mm.

**Figure 53. SO-8 schematic drawing of leader and trailer tape**


GAPG2004151511CFT

## 6.5 PowerSSO-16 marking information

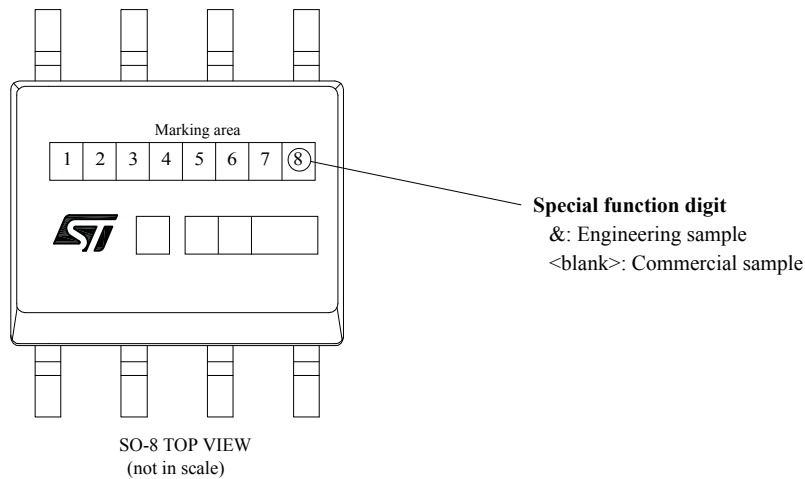
Figure 54. PowerSSO-16 marking information



Parts marked as '&' are not yet qualified and therefore not approved for use in production. ST is not responsible for any consequences resulting from such use. In no event will ST be liable for the customer using any of these engineering samples in production. ST's Quality department must be contacted prior to any decision to use these engineering samples to run a qualification activity.

## 6.6 SO-8 marking information

Figure 55. SO-8 marking information



**Note:** *Engineering Samples: these samples can be clearly identified by a dedicated special symbol in the marking of each unit. These samples are intended to be used for electrical compatibility evaluation only; usage for any other purpose may be agreed only upon written authorization by ST. ST is not liable for any customer usage in production and/or in reliability qualification trials.*

*Commercial Samples: fully qualified parts from ST standard production with no usage restrictions*

## 7 Order codes

**Table 22. Device summary**

Package	Order codes
	Tape and reel
PowerSSO-16	VN7040AJTR
SO-8	VN7040ASTR

## Revision history

**Table 23. Document revision history**

Date	Revision	Changes
04-Jun-2015	1	Initial release.
20-Jul-2015	2	Updated cover image. Updated <i>Table 4: "Thermal data"</i> Updated following sections: <ul style="list-style-type: none"> <li>• <i>Section 6.1: "PowerSSO-16 thermal data"</i></li> <li>• <i>Section 6.2: "SO-8 thermal data"</i></li> </ul>
02-Oct-2016	3	Updated the following: <ul style="list-style-type: none"> <li>• Features list on the cover page</li> <li>• <i>Figure 61: "PowerSSO-16 marking information"</i></li> </ul>
02-Jul-2018	4	Minor text changes in TCASE and VCC monitor.
04-Apr-2019	5	Updated <a href="#">Table 16. PowerSSO-16 mechanical data</a>



## Contents

<b>1</b>	<b>Block diagram and pin description</b> .....	<b>3</b>
<b>2</b>	<b>Electrical specification</b> .....	<b>5</b>
2.1	Absolute maximum ratings .....	5
2.2	Thermal data .....	6
2.3	Main electrical characteristics .....	6
2.4	Waveforms .....	16
2.5	Electrical characteristics curves .....	18
<b>3</b>	<b>Protections</b> .....	<b>23</b>
3.1	Power limitation .....	23
3.2	Thermal shutdown .....	23
3.3	Current limitation .....	23
3.4	Negative voltage clamp .....	23
<b>4</b>	<b>Maximum demagnetization energy (VCC = 16 V)</b> .....	<b>24</b>
<b>5</b>	<b>Package and PCB thermal data</b> .....	<b>25</b>
5.1	PowerSSO-16 thermal data .....	25
5.2	SO-8 thermal data .....	27
<b>6</b>	<b>Package information</b> .....	<b>31</b>
6.1	PowerSSO-16 package information .....	31
6.2	SO-8 package information .....	32
6.3	PowerSSO-16 packing information .....	33
6.4	SO-8 packing information .....	35
6.5	PowerSSO-16 marking information .....	37
6.6	SO-8 marking information .....	38
<b>7</b>	<b>Order codes</b> .....	<b>39</b>
	<b>Revision history</b> .....	<b>40</b>

## List of tables

<b>Table 1.</b>	Pin functions . . . . .	3
<b>Table 2.</b>	Suggested connections for unused and not connected pins . . . . .	4
<b>Table 3.</b>	Absolute maximum ratings . . . . .	5
<b>Table 4.</b>	Thermal data . . . . .	6
<b>Table 5.</b>	Power section . . . . .	6
<b>Table 6.</b>	Switching . . . . .	7
<b>Table 7.</b>	Logic inputs . . . . .	7
<b>Table 8.</b>	Protections . . . . .	9
<b>Table 9.</b>	MultiSense . . . . .	9
<b>Table 10.</b>	Truth table . . . . .	15
<b>Table 11.</b>	MultiSense multiplexer addressing . . . . .	15
<b>Table 12.</b>	PCB properties . . . . .	25
<b>Table 13.</b>	Thermal parameters . . . . .	27
<b>Table 14.</b>	PCB properties . . . . .	28
<b>Table 15.</b>	Thermal parameters . . . . .	30
<b>Table 16.</b>	PowerSSO-16 mechanical data . . . . .	32
<b>Table 17.</b>	SO-8 mechanical data . . . . .	33
<b>Table 18.</b>	Reel dimensions . . . . .	34
<b>Table 19.</b>	PowerSSO-16 carrier tape dimensions . . . . .	35
<b>Table 20.</b>	Reel dimensions . . . . .	36
<b>Table 21.</b>	SO-8 carrier tape dimensions . . . . .	37
<b>Table 22.</b>	Device summary . . . . .	39
<b>Table 23.</b>	Document revision history . . . . .	40

## List of figures

<b>Figure 1.</b>	Block diagram . . . . .	3
<b>Figure 2.</b>	Configuration diagram (top view). . . . .	4
<b>Figure 3.</b>	Current and voltage conventions. . . . .	5
<b>Figure 4.</b>	$I_{OUT}/I_{SENSE}$ versus $I_{OUT}$ . . . . .	12
<b>Figure 5.</b>	Current sense accuracy versus $I_{OUT}$ . . . . .	13
<b>Figure 6.</b>	Switching time and Pulse skew . . . . .	13
<b>Figure 7.</b>	MultiSense timings (current sense mode). . . . .	14
<b>Figure 8.</b>	Multisense timings (chip temperature and $V_{CC}$ sense mode) (VN7040AJ only) . . . . .	14
<b>Figure 9.</b>	$T_{DSTKON}$ . . . . .	15
<b>Figure 10.</b>	Latch functionality - behavior in hard short-circuit condition ( $T_{AMB} \ll T_{TSD}$ ) . . . . .	16
<b>Figure 11.</b>	Latch functionality - behavior in hard short-circuit condition. . . . .	17
<b>Figure 12.</b>	Latch functionality - behavior in hard short-circuit condition (autorestart mode + latch off) . . . . .	17
<b>Figure 13.</b>	Standby mode activation . . . . .	18
<b>Figure 14.</b>	Standby state diagram. . . . .	18
<b>Figure 15.</b>	OFF-state output current . . . . .	19
<b>Figure 16.</b>	Standby current . . . . .	19
<b>Figure 17.</b>	$I_{GND(ON)}$ vs. $T_{case}$ . . . . .	19
<b>Figure 18.</b>	Logic Input high level voltage . . . . .	19
<b>Figure 19.</b>	Logic Input low level voltage. . . . .	20
<b>Figure 20.</b>	High level logic input current. . . . .	20
<b>Figure 21.</b>	Low level logic input current . . . . .	20
<b>Figure 22.</b>	Logic Input hysteresis voltage. . . . .	20
<b>Figure 23.</b>	FaultRST Input clamp voltage. . . . .	20
<b>Figure 24.</b>	Undervoltage shutdown . . . . .	20
<b>Figure 25.</b>	On-state resistance vs. $T_{case}$ . . . . .	21
<b>Figure 26.</b>	On-state resistance vs. $V_{CC}$ . . . . .	21
<b>Figure 27.</b>	Turn-on voltage slope . . . . .	21
<b>Figure 28.</b>	Turn-off voltage slope . . . . .	21
<b>Figure 29.</b>	$W_{on}$ vs. $T_{case}$ . . . . .	21
<b>Figure 30.</b>	$W_{off}$ vs. $T_{case}$ . . . . .	21
<b>Figure 31.</b>	$I_{LIMH}$ vs. $T_{case}$ . . . . .	22
<b>Figure 32.</b>	OFF-state open-load voltage detection threshold . . . . .	22
<b>Figure 33.</b>	$V_{sense\ clamp}$ vs. $T_{case}$ . . . . .	22
<b>Figure 34.</b>	$V_{senseh}$ vs. $T_{case}$ . . . . .	22
<b>Figure 35.</b>	Maximum turn off current versus inductance. . . . .	24
<b>Figure 36.</b>	PowerSSO-16 on two-layers PCB (2s0p to JEDEC JESD 51-5) . . . . .	25
<b>Figure 37.</b>	PowerSSO-16 on four-layers PCB (2s2p to JEDEC JESD 51-7) . . . . .	25
<b>Figure 38.</b>	PowerSSO-16 $R_{thj-amb}$ vs PCB copper area in open box free air condition (one channel on) . . . . .	26
<b>Figure 39.</b>	PowerSSO-16 thermal impedance junction ambient single pulse (one channel on) . . . . .	26
<b>Figure 40.</b>	Thermal fitting model of a double-channel HSD in PowerSSO-16 . . . . .	27
<b>Figure 41.</b>	SO-8 on two-layers PCB (2s0p to JEDEC JESD 51-5) . . . . .	28
<b>Figure 42.</b>	SO-8 on four-layers PCB (2s2p to JEDEC JESD 51-7) . . . . .	28
<b>Figure 43.</b>	SO-8 $R_{thj-amb}$ vs PCB copper area in open box free air condition (one channel on) . . . . .	29
<b>Figure 44.</b>	SO-8 thermal impedance junction ambient single pulse (one channel on). . . . .	29
<b>Figure 45.</b>	Thermal fitting model of a double-channel HSD in SO-8. . . . .	30
<b>Figure 46.</b>	PowerSSO-16 package outline . . . . .	31
<b>Figure 47.</b>	SO-8 package outline . . . . .	33
<b>Figure 48.</b>	PowerSSO-16 reel 13" . . . . .	34
<b>Figure 49.</b>	PowerSSO-16 carrier tape . . . . .	35
<b>Figure 50.</b>	PowerSSO-16 schematic drawing of leader and trailer tape . . . . .	35

<b>Figure 51.</b>	Reel for SO-8 . . . . .	36
<b>Figure 52.</b>	SO-8 carrier tape . . . . .	37
<b>Figure 53.</b>	SO-8 schematic drawing of leader and trailer tape. . . . .	37
<b>Figure 54.</b>	PowerSSO-16 marking information . . . . .	38
<b>Figure 55.</b>	SO-8 marking information . . . . .	38

**IMPORTANT NOTICE – PLEASE READ CAREFULLY**

STMicroelectronics NV and its subsidiaries (“ST”) reserve the right to make changes, corrections, enhancements, modifications, and improvements to ST products and/or to this document at any time without notice. Purchasers should obtain the latest relevant information on ST products before placing orders. ST products are sold pursuant to ST’s terms and conditions of sale in place at the time of order acknowledgement.

Purchasers are solely responsible for the choice, selection, and use of ST products and ST assumes no liability for application assistance or the design of Purchasers’ products.

No license, express or implied, to any intellectual property right is granted by ST herein.

Resale of ST products with provisions different from the information set forth herein shall void any warranty granted by ST for such product.

ST and the ST logo are trademarks of ST. For additional information about ST trademarks, please refer to [www.st.com/trademarks](http://www.st.com/trademarks). All other product or service names are the property of their respective owners.

Information in this document supersedes and replaces information previously supplied in any prior versions of this document.

© 2019 STMicroelectronics – All rights reserved

Компания «Life Electronics» занимается поставками электронных компонентов импортного и отечественного производства от производителей и со складов крупных дистрибьюторов Европы, Америки и Азии.

С конца 2013 года компания активно расширяет линейку поставок компонентов по направлению коаксиальный кабель, кварцевые генераторы и конденсаторы (керамические, пленочные, электролитические), за счёт заключения дистрибьюторских договоров

Мы предлагаем:

- Конкурентоспособные цены и скидки постоянным клиентам.
- Специальные условия для постоянных клиентов.
- Подбор аналогов.
- Поставку компонентов в любых объемах, удовлетворяющих вашим потребностям.
- Приемлемые сроки поставки, возможна ускоренная поставка.
- Доставку товара в любую точку России и стран СНГ.
- Комплексную поставку.
- Работу по проектам и поставку образцов.
- Формирование склада под заказчика.
- Сертификаты соответствия на поставляемую продукцию (по желанию клиента).
- Тестирование поставляемой продукции.
- Поставку компонентов, требующих военную и космическую приемку.
- Входной контроль качества.
- Наличие сертификата ISO.

В составе нашей компании организован Конструкторский отдел, призванный помогать разработчикам, и инженерам.

Конструкторский отдел помогает осуществить:

- Регистрацию проекта у производителя компонентов.
- Техническую поддержку проекта.
- Защиту от снятия компонента с производства.
- Оценку стоимости проекта по компонентам.
- Изготовление тестовой платы монтаж и пусконаладочные работы.



Тел: +7 (812) 336 43 04 (многоканальный)

Email: [org@lifeelectronics.ru](mailto:org@lifeelectronics.ru)