

ITEM	Q'TY	PART NUMBER	PART DESCRIPTION
1	1	3XX-F	T-1 (3mm) Flanged LED, See Pages 2 to 4
2	1	ELM5XXX	Extruded, Self-Retaining Narrow LED Spacer

REV.	DESCRIPTION	DATE	APPROVED
D	Update BOM and Top View of ELM	11/07/06	M. C.
E	Added Low Current LEDs	01/04/07	M. C.
F	Corrected LED Part Numbers on Page 3	03/12/07	M. C.
G	Added 3SRC-F LED to Page 3	12/21/07	M. C.
H	Removed Tolerance Note.	09/03/08	M. C.
J	Added ELM5XXX3UYC Specs.	09/24/08	M. C.
K	Added Bi-Color LED Polarity Diagram.	03/29/10	T. Y.
L	Added Tape & Reel Options.	06/07/11	T. Y.
M	Tape & Reel Design Update.	11/21/11	T. Y.
N	LED Offering List Update	07/27/12	T. Y.

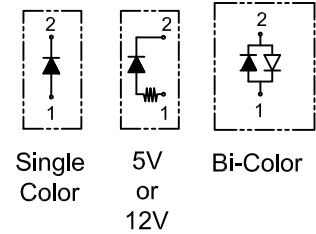

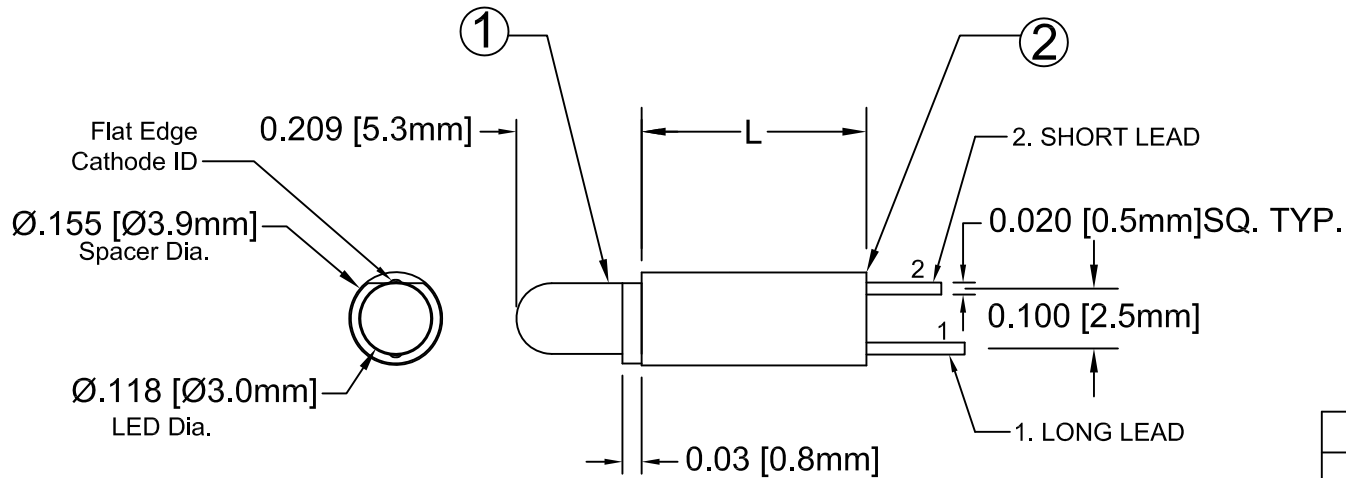
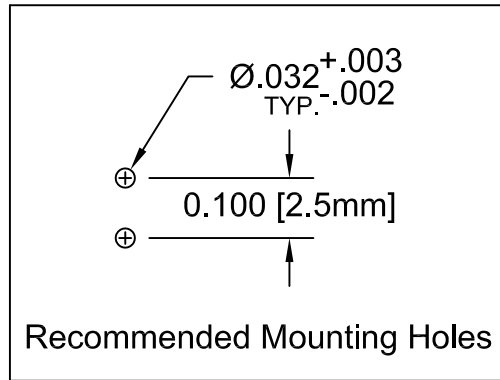

BI-COLOR POLARITY		
LED P/N	(1) Cathode	(2) Cathode
3BC-F	Green	Red
3BC-Y/G-F	Green	Yellow
3BC-R/Y-F	Yellow	Red
3BC-A/G-F	Green	Amber



ABSOLUTE MAXIMUM RATINGS (Ta=25°C)

REVERSE VOLTAGE	_____	5V
REVERSE CURRENT	_____	100µA
OPERATING TEMPERATURE RANGE	_____	-25° C - 85° C
STORAGE TEMPERATURE	_____	-30° C - 100° C
LEAD SOLDERING TEMPERATURE(1/16" FROM BODY)	_____	260° C FOR 5 SECONDS

STANDARD TOLERANCE (UNLESS OTHERWISE SPECIFIED)		 BIVAR [®] 4 THOMAS, IRVINE, CA. 92618 TEL: (949) 951-8808 FAX: (949) 951-3974	
DECIMALS	ANGULAR		
.X ±.1	X° ± 1°	 TITLE: EXTRUDED VERTICAL T-1 (3mm) LED NARROW SPACER PROFILE ASSY	
.XX ±.02			
.XXX ±.010			
DESIGNED: Minh Doan	DATE: 07/27/12	PART NO: ELM5XXX3XX	REVISION: N
CHECKED: T. Yin	DATE: 07/27/12	CAGE CODE : 32559	SHEET # 1 OF 5
CAD GENERATED DOCUMENT, DO NOT MEASURE DRAWING.			

REV.	DESCRIPTION	DATE	APPROVED
	SEE SHEET#1.		

LED Assy. No.	Chip			Lens Appearance	Electro-Optical Data @ 20mA				Viewing Angle 2 θ ½ (Deg)	LED P/N
	Material	Peak Wave Length	Emitted Color		If (mA)	Vf (V)		Iv (mcd)		
					MAX	TYP	MAX	TYP		
ELM5XXX3BWC	GaN/SiC	430	BLUE	WATER CLEAR	25	4	4.5	15	20	3BWC-F
ELM5XXX3BWD	GaN/SiC	430	BLUE	DIFFUSED	25	4	4.5	10	35	3BWD-F
ELM5XXX3BWT	GaN/SiC	430	BLUE	TINTED	25	4	4.5	15	20	3BWT-F
ELM5XXX3GC	GaP/GaP	568	GREEN	WATER CLEAR	30	2.1	2.8	40	20	3GC-F
ELM5XXX3GD	GaP/GaP	568	GREEN	DIFFUSED	30	2.1	2.8	25	35	3GD-F
ELM5XXX3GT	GaP/GaP	568	GREEN	TINTED	30	2.1	2.8	40	20	3GT-F
ELM5XXX3PGC	GaP/GaP	555	PURE GREEN	WATER CLEAR	30	2.2	2.8	10	20	3PGC-F
ELM5XXX3PGD	GaP/GaP	555	PURE GREEN	DIFFUSED	30	2.2	2.8	5	35	3PGD-F
ELM5XXX3PGT	GaP/GaP	555	PURE GREEN	TINTED	30	2.2	2.8	10	20	3PGT-F
ELM5XXX3YC	GaAsP/GaP	590	YELLOW	WATER CLEAR	30	2	2.8	40	20	3YC-F
ELM5XXX3YD	GaAsP/GaP	590	YELLOW	DIFFUSED	30	2	2.8	20	35	3YD-F
ELM5XXX3YT	GaAsP/GaP	590	YELLOW	TINTED	30	2	2.8	40	20	3YT-F
ELM5XXX3AC	GaAsP/GaP	605	AMBER	WATER CLEAR	30	2	2.8	40	20	3AC-F
ELM5XXX3AD	GaAsP/GaP	605	AMBER	DIFFUSED	30	2	2.8	25	35	3AD-F
ELM5XXX3AT	GaAsP/GaP	605	AMBER	TINTED	30	2	2.8	40	20	3AT-F
ELM5XXX3HC	GaAsP/GaP	625	HE RED	WATER CLEAR	30	2	2.8	50	20	3HC-F
ELM5XXX3HD	GaAsP/GaP	625	HE RED	DIFFUSED	30	2	2.8	30	35	3HD-F
ELM5XXX3HT	GaAsP/GaP	625	HE RED	TINTED	30	2	2.8	50	20	3HT-F
ELM5XXX3RC	GaP/GaP	700	RED	WATER CLEAR	20	2.1	2.8	2.5	35	3RC-F
ELM5XXX3RD	GaP/GaP	700	RED	DIFFUSED	20	2.1	2.8	2	20	3RD-F
ELM5XXX3RT	GaP/GaP	700	RED	TINTED	20	2.1	2.8	2.5	20	3RT-F
ELM5XXX3BC-A/G	GaAsP/GaP	605	AMBER	DIFFUSED	30	2.0	2.8	6	45	3BC-A/G-F
	GaP/GaP	568	GREEN		30	2.1	2.8	6		
ELM5XXX3BC	GaAsP/GaP	625	RED	DIFFUSED	30	2.0	2.8	6	45	3BC-F
	GaP/GaP	568	GREEN		30	2.1	2.8	6		
ELM5XXX3BC-R/Y	GaAsP/GaP	625	RED	DIFFUSED	30	2.0	2.8	6	45	3BC-R/Y-F
	GaAsP/GaP	590	YELLOW		30	2.0	2.8	4		
ELM5XXX3BC-Y/G	GaAsP/GaP	590	YELLOW	DIFFUSED	30	2.0	2.8	4	45	3BC-Y/G-F
	GaP/GaP	568	GREEN		30	2.1	2.8	6		

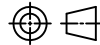
STANDARD TOLERANCE (UNLESS OTHERWISE SPECIFIED) ±10% ALL VALUES		 BIVAR [®] 4 THOMAS, IRVINE, CA. 92618 TEL: (949) 951-8808 FAX: (949) 951-3974	
ANGULAR X° ± 5°			
		TITLE: EXTRUDED VERTICAL T-1 (3mm) LED STANDARD PROFILE SPACER ASSY	
DESIGNED: Minh Doan	DATE: 07/27/12	PART NO: ELM5XXX3XX	REVISION: N
CHECKED: T. Yin	DATE: 07/27/12	CAGE CODE : 32559	SHEET # 2 OF 5
CAD GENERATED DOCUMENT, DO NOT MEASURE DRAWING.			

REV.	DESCRIPTION	DATE	APPROVED
	SEE SHEET#1.		

LED Assy. No.	Chip			Lens Appearance	Electro-Optical Data @ 20mA				Viewing Angle 2θ ½ (Deg)	LED P/N
	Material	Peak Wave Length	Emitted Color		If (mA)	Vf (V)		Iv (mcd)		
					MAX	TYP	MAX	TYP		
ELM5XXX3UBWC	GaN/SiC	470	BLUE	WATER CLEAR	30	4	4.5	400	30	3UBWC-0.6K-F
ELM5XXX3SGC	GaP/GaP	568	GREEN	WATER CLEAR	30	2.1	2.8	50	20	3SGC-F
ELM5XXX3SGD	GaP/GaP	568	GREEN	DIFFUSED	30	2.1	2.8	30	35	3SGD-F
ELM5XXX3SGT	GaP/GaP	568	GREEN	TINTED	30	2.1	2.8	50	20	3SGT-F
ELM5XXX3SYC	GaAsP/GaP	590	YELLOW	WATER CLEAR	30	2.0	2.8	50	20	3SYC-F
ELM5XXX3SYD	GaAsP/GaP	590	YELLOW	DIFFUSED	30	2.0	2.8	30	35	3SYD-F
ELM5XXX3SYT	GaAsP/GaP	590	YELLOW	TINTED	30	2.0	2.8	50	20	3SYT-F
ELM5XXX3SAC	AlGaInP	605	AMBER	WATER CLEAR	30	1.8	2.4	300	20	3SAC-F
ELM5XXX3SAD	AlGaInP	605	AMBER	DIFFUSED	30	1.8	2.4	100	35	3SAD-F
ELM5XXX3SAT	AlGaInP	605	AMBER	TINTED	30	1.8	2.4	300	20	3SAT-F
ELM5XXX3SRC	GaAlAs/GaAs	645	SUPER RED	WATER CLEAR	30	1.7	2.4	60	20	3SRC-F
ELM5XXX3SRD	GaAlAs/GaAs	645	SUPER RED	DIFFUSED	30	1.7	2.4	40	35	3SRD-F
ELM5XXX3SRT	GaAlAs/GaAs	645	SUPER RED	TINTED	30	1.7	2.4	60	20	3SRT-F
ELM5XXX3UGC	AlGaInP	570	GREEN	WATER CLEAR	30	2.1	2.4	200	20	3UGC-F
ELM5XXX3UGC	AlGaInP	570	GREEN	WATER CLEAR	30	2.1	2.4	300	35	3SUGC-F
ELM5XXX3UYC	AlGaInP	590	YELLOW	WATER CLEAR	30	2.0	2.4	300	20	3UYC-F
ELM5XXX3SUYC	AlGaInP	590	YELLOW	WATER CLEAR	30	2.0	2.4	400	20	3SUYC-F
ELM5XXX3UUYC	AlGaInP	590	YELLOW	WATER CLEAR	30	2.0	2.4	600	35	3UUYC-F
ELM5XXX3UOC	AlGaInP	625	ORANGE	WATER CLEAR	30	1.8	2.4	300	20	3UOC-F
ELM5XXX3SUOC	AlGaInP	625	ORANGE	WATER CLEAR	30	1.8	2.4	400	20	3SUOC-F
ELM5XXX3URC	GaAlAs/GaAs	645	RED	WATER CLEAR	30	1.7	2.4	200	35	3URC-F
ELM5XXX3SURC	AlGaInP	640	RED	WATER CLEAR	30	1.8	2.4	200	20	3SURC-F
ELM5XXX3UWC	InGaN/Sapphire	6500K	WHITE	WATER CLEAR	30	3.4	3.8	1000	35	3UWC1.030C-F

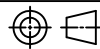
STANDARD TOLERANCE (UNLESS OTHERWISE SPECIFIED) ±10% ALL VALUES		 BIVAR ® 4 THOMAS, IRVINE, CA. 92618 TEL: (949) 951-8808 FAX: (949) 951-3974	
ANGULAR X° ± 5°			
DESIGNED: Minh Doan		DATE: 07/27/12	 TITLE: EXTRUDED VERTICAL T-1 (3mm) LED STANDARD PROFILE SPACER ASSY
CHECKED: T. Yin		DATE: 07/27/12	
		PART NO: ELM5XXX3XX	REVISION: N
		CAGE CODE: 32559	SHEET # 3 OF 5
CAD GENERATED DOCUMENT, DO NOT MEASURE DRAWING.			

REV.	DESCRIPTION	DATE	APPROVED
	SEE SHEET#1.		

LED Assy. No.	Chip			Lens Appearance	Absolute Max. Ratings			Electro-Optical Data @ 2mA			Viewing Angle 2θ½ (Deg)	LED P/N
	Material	Peak Wave Length λp(nm)	Emitted Color		Pd (mW)	If (mA)	Peak If(mA)	Vf (V)		Iv (mcd)		
								TYP	MAX	TYP		
ELM5XXX3BWDL	GaN/siC	430	BLUE	DIFFUSED	20	7	-	3.8	4.2	2.5	35	3BWDL-F
ELM5XXX3GDL	GaP/GaP	568	GREEN	DIFFUSED	10	7	-	2.1	2.6	4.0	35	3GDL-F
ELM5XXX3PGDL	GaP/GaP	555	PURE GREEN	DIFFUSED	10	7	-	2.1	2.6	0.2	35	3PGDL-F
ELM5XXX3YDL	GaAsP/GaP	590	YELLOW	DIFFUSED	10	7	-	2.0	2.6	2.0	35	3YDL-F
ELM5XXX3ADL	GaAsP/GaP	605	AMBER	DIFFUSED	10	7	-	2.0	2.6	4.0	35	3ADL-F
ELM5XXX3HDL	GaAsP/GaP	625	HE RED	DIFFUSED	10	7	-	2.0	2.6	2.5	35	3HDL-F
ELM5XXX3RDL	GaP/GaP	700	RED	DIFFUSED	10	7	-	2.1	2.6	0.5	35	3RDL-F
ELM5XXX3SRDL	GaAlAs/GaAs	645	RED	DIFFUSED	10	7	-	2.0	-	8.0	35	3SRDL-F

Assembly P/N	Peak Wave Length λp(nm)	Emitted Color	Lens Appearance	Electro-Optical Data				Viewing Angle 2θ½ (Deg)	LED P/N
				If (mA)	Vf (V)		Iv (mcd)		
					MAX	TYP	MAX		
5 Volt				Data @ 5V					
ELM5XXX3BWD5V	BLUE	430	DIFFUSED	-	-	5	10	35	3BWD5V-F
ELM5XXX3GC5V	GREEN	568	WATER CLEAR	-	-	5	40	20	3GC5V-F
ELM5XXX3GD5V	GREEN	568	DIFFUSED	-	-	5	25	35	3GD5V-F
ELM5XXX3GT5V	GREEN	568	TINTED	-	-	5	40	20	3GT5V-F
ELM5XXX3AD5V	AMBER	605	DIFFUSED	-	-	5	25	35	3AD5V-F
ELM5XXX3HD5V	HE RED	625	DIFFUSED	-	-	5	30	35	3HD5V-F
ELM5XXX3RD5V	RED	700	DIFFUSED	-	-	5	2	35	3RD5V-F
ELM5XXX3YD5V	YELLOW	590	DIFFUSED	-	-	5	20	35	3YD5V-F
12 Volt				Data @ 12V					
ELM5XXX3GC12V	GREEN	568	WATER CLEAR	-	-	12	40	20	3GC12V-F
ELM5XXX3GD12V	GREEN	568	DIFFUSED	-	-	12	25	35	3GD12V-F
ELM5XXX3HC12V	HE RED	625	WATER CLEAR	-	-	12	50	20	3HC12V-F
ELM5XXX3HD12V	HE RED	625	DIFFUSED	-	-	12	30	35	3HD12V-F
ELM5XXX3RC12V	RED	700	WATER CLEAR	-	-	12	6	20	3RC12V-F
ELM5XXX3RD12V	RED	700	DIFFUSED	-	-	12	2	35	3RD12V-F
ELM5XXX3YC12V	YELLOW	590	WATER CLEAR	-	-	12	40	20	3YC12V-F
ELM5XXX3YD12V	YELLOW	590	DIFFUSED	-	-	12	25	35	3YD12V-F

STANDARD TOLERANCE (UNLESS OTHERWISE SPECIFIED) ±10% ALL VALUES		 BIVAR [®] 4 THOMAS, IRVINE, CA. 92618 TEL: (949) 951-8808 FAX: (949) 951-3974	
ANGULAR X° ± 5°			
DESIGNED: Minh Doan		DATE: 07/27/12	TITLE: EXTRUDED VERTICAL T-1 (3mm) LED STANDARD PROFILE SPACER ASSY PART NO: ELM5XXX3XX REVISION: N
CHECKED: T. Yin		DATE: 07/27/12	
		CAGE CODE : 32559	SHEET # 4 OF 5
CAD GENERATED DOCUMENT. DO NOT MEASURE DRAWING.			

Компания «Life Electronics» занимается поставками электронных компонентов импортного и отечественного производства от производителей и со складов крупных дистрибьюторов Европы, Америки и Азии.

С конца 2013 года компания активно расширяет линейку поставок компонентов по направлению коаксиальный кабель, кварцевые генераторы и конденсаторы (керамические, пленочные, электролитические), за счёт заключения дистрибьюторских договоров

Мы предлагаем:

- Конкурентоспособные цены и скидки постоянным клиентам.
- Специальные условия для постоянных клиентов.
- Подбор аналогов.
- Поставку компонентов в любых объемах, удовлетворяющих вашим потребностям.
- Приемлемые сроки поставки, возможна ускоренная поставка.
- Доставку товара в любую точку России и стран СНГ.
- Комплексную поставку.
- Работу по проектам и поставку образцов.
- Формирование склада под заказчика.
- Сертификаты соответствия на поставляемую продукцию (по желанию клиента).
- Тестирование поставляемой продукции.
- Поставку компонентов, требующих военную и космическую приемку.
- Входной контроль качества.
- Наличие сертификата ISO.

В составе нашей компании организован Конструкторский отдел, призванный помогать разработчикам, и инженерам.

Конструкторский отдел помогает осуществить:

- Регистрацию проекта у производителя компонентов.
- Техническую поддержку проекта.
- Защиту от снятия компонента с производства.
- Оценку стоимости проекта по компонентам.
- Изготовление тестовой платы монтаж и пусконаладочные работы.



Тел: +7 (812) 336 43 04 (многоканальный)

Email: org@lifeelectronics.ru