

TM105065-2 Trackpad

Specification

Document Version 1.1.1

NOVEMBER 2016



This document describes Cirque's TM105065-2 trackpad (105.00 x 65.00 mm, 10 - pin connector, 3.0-5.5 V., USB or I2C interface):

- TM105065-2-R04U-0500-10
- TM105065-2-R04I-0500-10

This document supersedes all previous versions. Sample hardware and firmware are available upon request.

Document Version History

Date	Current Version	Description
NOVEMBER 2014	1.0	Initial documentation release
JANUARY 2015	1.1	Added the 1.3 firmware version power specification
NOVEMBER 2016	1.1.1	Updated Sample Rate vs Tracking Speed data. Edited for readability.

Notice

This document is the sole property of Cirque Corporation. The information contained within is proprietary to Cirque Corporation. The holder of this document shall treat all information contained herein as confidential, shall use the information only for its intended purpose, and shall protect the information in whole or in part from duplication, disclosure to any other party, or dissemination in any media without written permission from Cirque Corporation.

Note to Purchasers: All specifications subject to change without notice. Cirque shall not be liable for any damages whether non-specified, direct, indirect, special, incidental or consequential (including downtime, loss of profit or goodwill) regardless of the legal theory asserted. This document supersedes all previous versions.

Copyright, Trademark, and Patent Information

Copyright© 2016 Cirque Corporation. All Rights Reserved. Cirque®, the Cirque logo, GlidePoint®, the GlidePoint logo, and GlideExtend® are trademarks of Cirque Corporation. All other brand names or trademarks are the property of their respective owners.

Cirque's touch controller platforms and technology solutions are protected by patents and additional U.S. and International patents pending. Contact Cirque for more information.

Table of Contents

Introduction	4
Gen 4 Product Line Benefits	5
General Specifications	6
Physical Dimensions	8
Interface Specifications	9
I2C HID Communication	9
USB Communication	9
User Interaction	13
Buttons or Click Trackpad	13
Configurable Options	13
Advanced Gestures (AG)	13
Overlay Options	17
Design Recommendations	18
Implementing the Click Trackpad	18
Mounting the Click Trackpad	19
Mounting Reference Design	19
Mounting Methods.....	20
ESD Protection and EMI Specification	22
EMI Susceptibility.....	22
Contact Information	23
Part Ordering Information	23

Introduction

The TM105065-2 trackpad is based on Cirque's GlidePoint® Gen 4 technology, which is also referred to as Gen 4. Cirque's Gen 4 technology features Image Sensing technology and provides native multi-touch gestures without requiring a custom driver. Depending on your business needs, the TM105065-2 supports up to three buttons or it can be a “button-less” Click Trackpad solution.

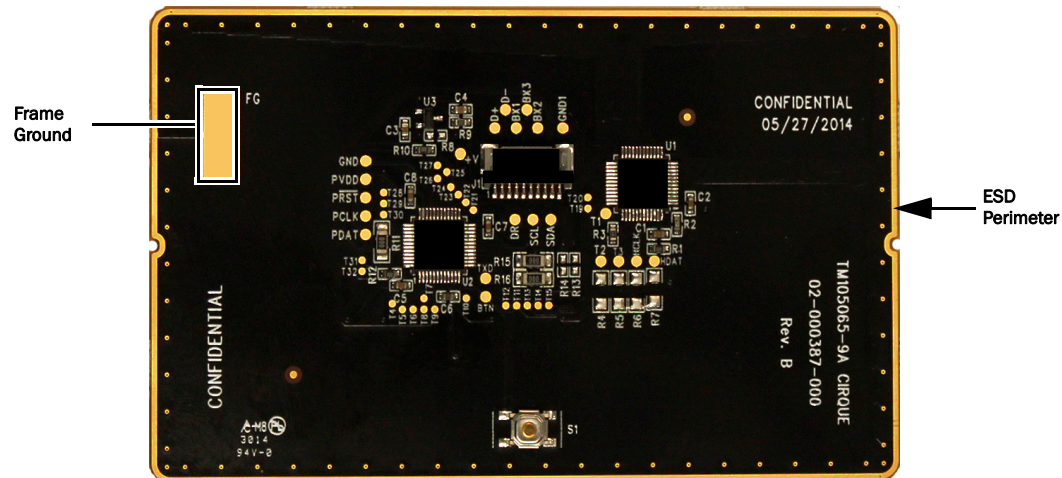

Figure 1. The Component Side of the TM105065-2 Trackpad Module

This document describes the TM105065-2 trackpad solution’s mechanical and electrical specifications. Suggested design considerations are also provided.

Note: I2C must be supported by the OS to use the I2C version of the trackpad.

Cirque GlidePoint trackpads provide precise, smooth, and effortless cursor control. The TM105065-2 uses patented GlidePoint technology, which is based on a mutual capacitance system. Located below the trackpad's durable surface is a sophisticated sensing array, which accurately responds to even the smallest finger movements. No finger pressure is required; simply move a finger across the trackpad to move the cursor. Tap on the pad to click; tap on the pad twice to double-click; and tap twice and then hold to drag, draw, and highlight.

Benefits of the TM105065-2 Trackpad

Cirque's latest generation of trackpads define the standard for the pointing device industry. These solid-state devices are extremely durable because they have no moving parts to break down. This as well as the following benefits, makes the TM105065-2 an ideal solution for integration.

-
- | | |
|--|---|
| • Uses Cirque's Gen 4 technology. | • Gestures work on all supported applications. |
| • Field upgradable. | • Able to track 5 points and report X and Y data. |
| • Swipe Gestures available. | • Highly reliable and durable. |
| • Superior navigation and high responsiveness. | • Built-in precise positioning. |
| • Environmentally sealed design. | • Built-in palm rejection. |
| • Adaptable and collaborative support for integrating this solution into your product. | • Advanced, multi-touch gestures without requiring an additional driver installation. |
-

Gen 4 Product Line Benefits

The GlidePoint Gen 4 image sensor uses a proprietary analog front end and customized MCU with flash memory, which provides the following benefits:

- Native multi-touch gestures - no additional driver installation is required.
- Built-in palm rejection technology.
- Optimized for the I2C and USB protocol.
- Excellent processing and measurement.
- Exceptional noise immunity.
- Superior default motion.

Cirque's GlidePoint trackpads operate as a standard mouse, and provide smooth and precise cursor control with no additional software for basic functions. The trackpad accurately responds to even the smallest finger movements, simply:

- Move a finger across the trackpad to move the cursor.
- Tap the pad to click.
- Tap the pad twice to double-click.
- Tap twice and then hold to drag, draw, and highlight.

Previously, it was necessary to install a driver for advanced gestures. Gen 4 provides multi-touch, gestures (that is, advanced scroll, zoom, and other gesture capabilities) regardless of the operating system¹. For more information about [Advanced Gestures \(AG\)](#), see [page 13](#).

The firmware in Gen 4 trackpads includes superior cursor ballistics that has been optimized for best performance. These ballistics provide enhanced precision and cursor control. The palm rejection technology in the Gen 4 firmware detects large objects touching the trackpad. When a large object, or multiple objects, is on the trackpad, cursor movement is prevented.

¹ Gestures are dependent on the application. If the application supports the keystroke short cut, the gesture will occur regardless of the OS.

General Specifications

Operational Specifications

Position Detection Method:	Mutual capacitance sensing
X/Y Position Sensing Resolution:	Up to 50 counts/mm
X/Y Position Reporting:	Relative (similar to a mouse), or Absolute (via a register write)
Sample Rate:	Up to 100 samples/sec.
Touch Force:	No contact pressure required
Lifetime: (Cirque Plastic Overlay)	Minimum 10,000,000 strokes (500 km)
	Note: These specifications are for Cirque's overlay. A custom overlay would need to be tested. See Overlay Options on page 17 .

Environmental Specifications

Operating Temperature: (Measured on component side.)	-40 to 85 °C
Operating Humidity at High Temperature:	Up to 95% relative humidity (Non-condensing)*
Storage Temperature:	-40 to 125 °C
Storage Humidity:	5% to 95% relative humidity (Non-condensing)*
ESD: (Applied to sensing surface)	Up to ±15 kV when module is properly installed (targeted)

* Only for Humidity test. Humidity is not controlled for any other tests.

Note: For more information, see the [CT-120305 Environmental Test](#) document.

Interface Specifications

Communication Protocol:	USB or I2C
Driver Requirements:	No driver installation required
	Note: A Cirque driver is not currently available for this product
Mechanical Buttons:	Supports up to three buttons or a "button-less" Click Trackpad solution

Overlay and Mounting Specifications

Overlay Material:	Glass or plastic
*Overlay Thickness:	Standard plastic overlay is 0.3 mm Standard glass overlay is 0.7 mm See Overlay Options on page 17
*Trackpad Mounting:	See Mounting the Click Trackpad on page 19

*These specifications are determined by your design. Contact Cirque for more information.

Physical Specifications

Module Thickness:	3.75 mm Max (PCB + Components) 0.74 ±0.07 mm (PCB) (Does not include an overlay.)
Module Length:	105.00 ±0.20 mm
Module Width:	65.00 ±0.20 mm
Module Weight:	< 14 grams (Does not include an overlay.)
Active Sensing Area:	105.00 x 65.00 ±0.20 mm

Note: Please see [Figure 2 on page 8](#) for a detailed drawing of the TM105065-2 module

Typical Electrical Specifications

Note: Cirque uses Microsoft's Power Consumption Requirement formula for I2C average power:
(0.9 x IDLE in mA) + (0.1 x Active in mA)
This formula is described in the [Windows Precision Touchpad Implementation Guide](#), which can be downloaded from [Microsoft's web site](#).

I2C Voltage Range: 3.0 to 5.5 Volts

Average power consumption:	1.9 mA
*Shutdown:	20 µA
Idle:	0.1 mA
Active - Not Touched:	0.5 mA
Active - Touched:	18 mA

* Shutdown is activated by software command from the host. The trackpad returns to the Active mode by a button press or a command can be sent to exit shutdown mode.

USB Voltage Range: 3.0 to 5.5 Volts

Suspend - not wake-enabled:	0.3 mA
Suspend - wake-enabled:	0.7 mA
Active - Touched:	20 mA

Physical Dimensions

This section provides the dimensions of the TM105065-2 (Figure 2). These dimensions do not include an overlay.

Note: Unless otherwise noted, all dimensions shown in mechanical drawings are in millimeters and are not to scale; all dimensional tolerances are ± 0.15 mm.

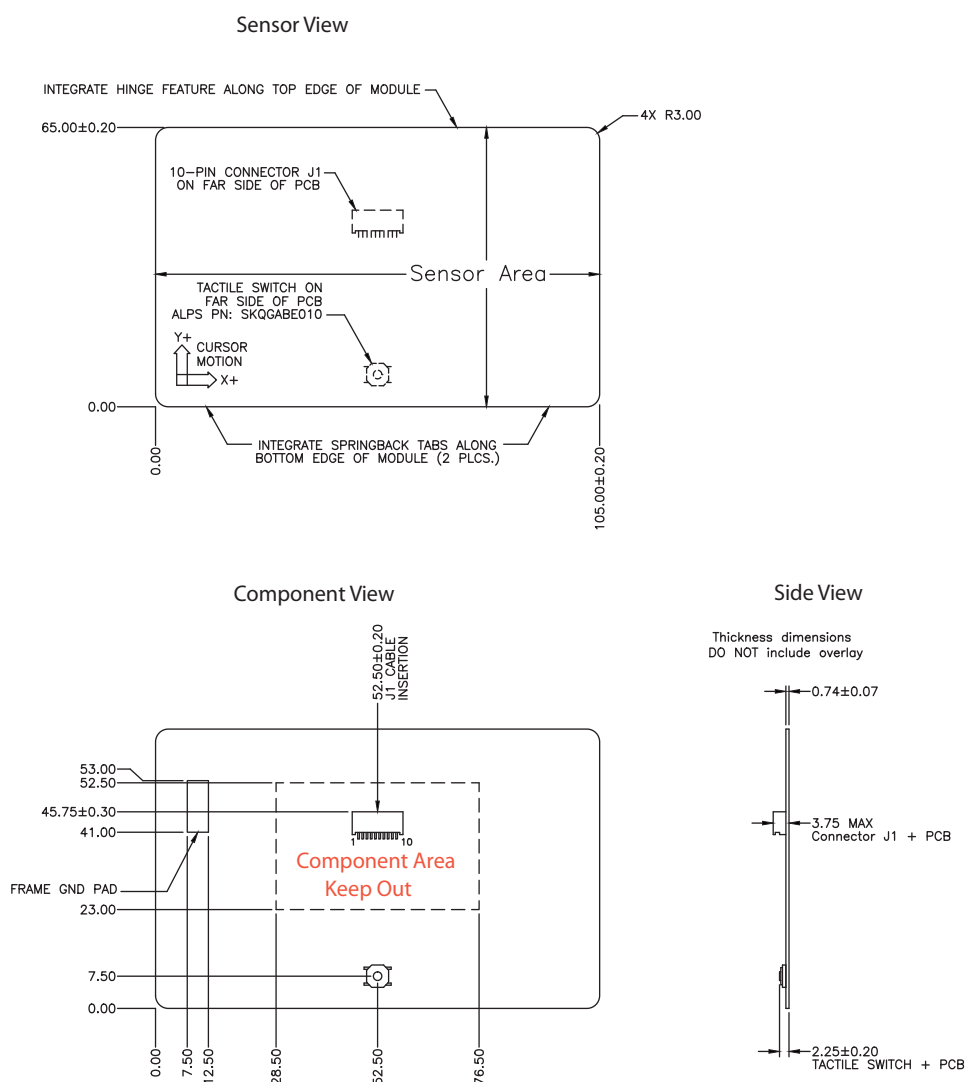

Figure 2. TM105065-2 Physical Dimensions - Sensor, Component, and Side Views

Interface Specifications

The TM105065-2 can be ordered as either an I2C or a USB device. This section describes these system interfaces, connector pins, and cables for both protocols.

I2C HID Communication

The I2C protocol is a simple and cost effective standard for reading position data. Further information regarding the I2C protocol is included in the [Interfacing to Cirque's GlidePoint Gen 4 through I2C](#) document. This document can be requested through Cirque's website (<http://www.cirque.com>).

USB Communication

The TM105065-2 passes USB compliance. USB communication between the trackpad and the host computer is based upon the USB HID class protocols presented in the [Universal Serial Bus Specification \(version 2.0\)](#) and [USB Class Definition for Human Interface Devices \(HID\) \(version 1.11\)](#).

The Byte Number value determines if the packet information is for a mouse or keyboard (see [Table 1](#)). The Keyboard packet is shown in [Table 2](#) below. The Mouse packet is shown in [Table 4 on page 10](#).

Table 1. Gen 4 Data Format - Byte Number

Byte Number	Name	Description
0	ReportID	The unique identification assigned to each report, which is used to distinguish between mouse and keyboard data. For example, the mouse packet's report ID is 6 and a keyboard packet's report ID is 8.

Table 2. Keyboard Packet - Report ID 8

Byte Number	Name	Description
1	Modifier Keys	Bit 7 Right GUI Bit 6 Right Alt Bit 5 Right Shift Bit 4 Right Ctrl Bit 3 Left GUI Bit 2 Left Alt Bit 1 Left Shift Bit 0 Left Ctrl
2	Reserved	Reserved
3	Keycode 1	- Report ID 8
4	Keycode 2	Not used
5	Keycode 3	Not used
6	Keycode 4	Not used
7	Keycode 5	Not used
8	Keycode 6	Not used

Table 3. Keycode Table for Keycode 1 - Report ID 8

Value	Gesture	Key	Description
7	Minimize all	Letter "D"	Used for the Windows Logo key + D key command.
80	Back command	Left arrow	Used for the Alt + left arrow function.
79	Forward command	Right arrow	Used for the Alt + right arrow function.
6	Windows 8 Right edge	Left "C"	Used for the Windows Logo key + C key command.
43	Windows 8 Left edge	Tab	Used for the Windows Logo key + Tab key command.
29	Windows 8 Top edge	Letter "Z"	Used for the Windows Logo key + Z key command.

Table 4. Mouse Packet Format - Report ID 6

Byte Number	Name	Description
1	Buttons	The button data.
2	X Delta	The X-motion deltas, signed 8-bit value.
3	Y Delta	The Y-motion deltas, signed 8-bit value.
4	Scroll Delta	The Vertical-scroll deltas, signed 8-bit value.
5	Pan Delta	The Horizontal-scroll deltas, signed 8-bit value.

Relative or Absolute Mode

Regardless of the protocol, positions may be reported in either relative or absolute mode. In relative mode, touch positions are reported in a comparative manner, the instantaneous position is always a DELTA, or change, with respect to the previous position. DELTAs are expressed in Two's-complement notation. In absolute mode, touch positions are reported as unmodified data.

Host Interface

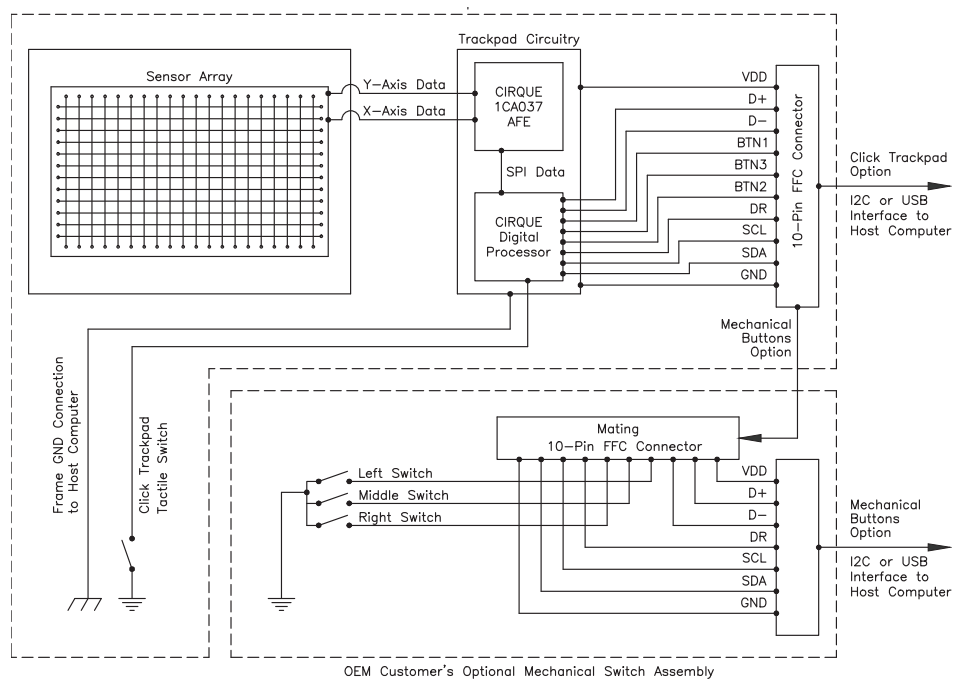

Figure 3. TM105065-2 System Interface Block Diagram

Connection to Host Computer

The 10-pin connector mounted on the trackpad module supports power supply, up to three separate button functions (primary, secondary, and auxiliary input), and USB & I2C signals (Table 5 on page 11).

WARNING: You must connect the 1st pin on the cable connector to the 1st pin on the board (J1). If the cable connection is reversed, hardware damage will occur.

Table 5. Pin Order for 10-Pin Connector

1	2	3	4	5	6	7	8	9	10
VDD	D+	D-	BTN1	BTN3	BTN2	DR	SCL	SDA	GND

The connecting cable and mating connector are not included with the module. Both can be included as an additional option. See Table 6 and Table 7 on page 12 for supplier and manufacturing information.

Table 6. FFC Cable Manufacturing Sources

Manufacturer	Description	Part Number
Axon Cable, Inc. (http://www.axon-cable.com)	Custom length FFC cable	FFC1.00A10/XXXXE4.0-4.0-06.0-06.0FB (Replace XXXX with desired insulated length in mm)
DigiKey (http://www.digikey.com)	Flat Flex, Ribbon Jumper cable	WM100xx-ND (Replace XXX with desired length in mm)

Table 7. Connector Manufacturing Sources

Manufacturer	Description	Part Number
J.S.T. Corporation (http://www.jst.com)	FFC Connector	10FMS-1.0SP-TF(LF)(SN)

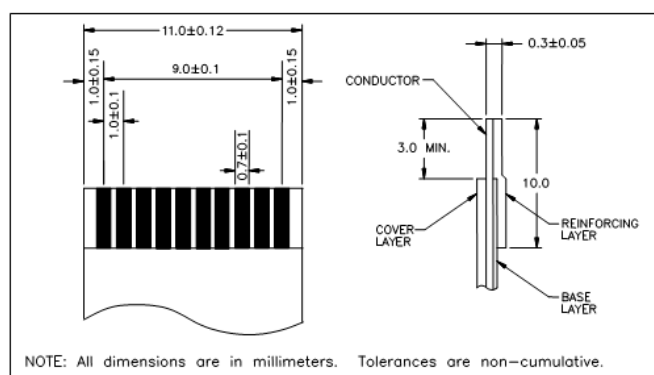

Figure 4. 10-pin FFC/FPC Lead Section Dimensions

User Interaction

This section describes how users can interact with the trackpad. For example, buttons, native multi-touch Advanced Gestures, configurable options, and GlideExtend®.

Buttons or Click Trackpad

The TM105065-2 can support up to three separate button inputs. In addition, Cirque offers a Click Trackpad, where the entire trackpad surface can be used for cursor movement in addition to being used as a button. OEM customers may design and manufacture their own mechanical switch assembly when integrating buttons into their own custom enclosure.

The location, and physical shape of buttons, is open to the discretion of the OEM customer on the traditional trackpad only. For ergonomic reasons, low-profile switch caps should be located near the bottom edge of the bezel window. Cirque recommends using short and wide switch cap designs to prevent inadvertent button activation while using the trackpad. The 10-pin flat-flex cable (FFC) must route signals from the trackpad module to a mating connector on the switch assembly.

GlideExtend

The TM105065-2 includes GlideExtend, Cirque's patented motion extender. GlideExtend differs from other motion extension approaches by allowing the user to retain direct control of the cursor at all times. When the user's finger encounters the edge of the trackpad during a drag, draw, or highlight operation, GlideExtend temporarily holds this function so that the user may lift and then reposition their finger (similar to repositioning a mouse on a mouse pad). Thus, the user is always in control and is never required to "steer" as the cursor begins to coast in the direction of the finger. GlideExtend is enabled.

Configurable Options

Gen 4 offers two configurable gesture suites, a single finger suite and a multi-finger suite. Any gestures can be selected or disabled in either suite, allowing you to customize either gesture suite to meet your business needs. However, you cannot select gestures in both suites. These suites are customized through the USB interface. Contact Cirque for more information (see [Contact Information on page 23](#).)

Advanced Gestures (AG)

Cirque's GlidePoint TM105065-2 trackpad features single and multi-touch Advanced Gestures™, all without the need of a custom driver.

Note: *Currently, the Cirque GlidePoint driver is not available for this product. The OS must support I2C to use the I2C version of the trackpad.*

Users are able to interact in advanced ways without ever leaving the trackpad, allowing your devices to become even more useful to your customers. Gesture enabled devices offer the following:

Efficient Usability Experiences: Gestures allow users to activate programs and actions on the device. Familiar gestures that people use every day are easily made. For example, zooming in on pictures, and panning or scrolling through documents; all without having to perform multiple clicks and using menu bars. Gestures make it easier for your customers to use your devices.

Intuitive Interactions: Gestures are designed to function like everyday activities. A simple flick of your fingers, similar to turning a book page, will activate the back button on a web browser and other utilities. Dragging two fingers down the trackpad let users read a whole document without ever pushing a button. All open windows minimize by simply swiping three fingers in a downward motion.

Slides and Taps

The following slides or taps are supported:

- **Single-finger slide:** Moves the mouse cursor.
- **Tap:** Primary button click.
- **Double tap:** Double click at the current cursor position.
- **Two Finger tap:** Activates right click menu.

Two-Finger Gestures

Gesture functions are subject to change with new releases.

Pinch/Zoom

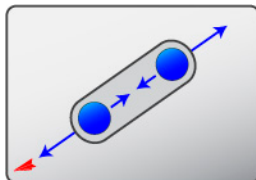

Place two fingers on the trackpad and expand the distance between the two fingers to zoom (enlarge the image view) or bring the fingers closer together to zoom out (shrink the image view).

Vertical Scroll/Pan

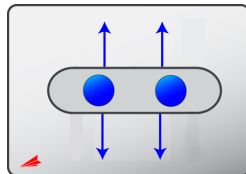

Move two fingers together on the trackpad to scroll vertically. Moving either up or down will scroll in that direction.

Horizontal Scroll/Pan

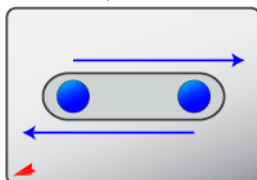

Move two fingers together on the trackpad to scroll horizontally (pan). Moving either left or right will scroll in that direction.

Three-Finger Gestures

Back/Forward

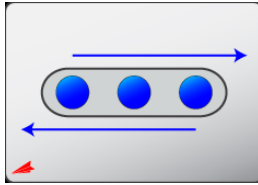

Flick three fingers quickly on the trackpad to go back and forward.

- Flick left to go back.
- Flick right to go forward.

Launch Start Menu

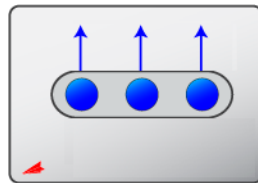

Flick three fingers upward on the trackpad to launch the Start Menu.

Minimize

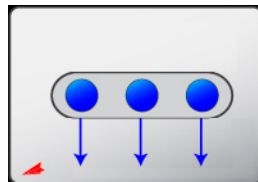

Flick three fingers downward on the trackpad to minimize the active window.

Swipe Gestures

In addition to the above gestures, the following Swipe gestures are supported.

Note: *Windows 8 gestures are only available to Windows 8 users.*

Swipe from Right Edge

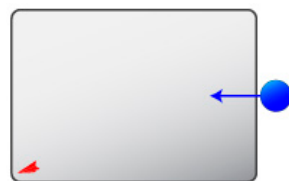

Place finger on the edge and then swipe from right edge onto the sensitive area of the trackpad. This act will toggle the charm bar.

Swipe from Top Edge

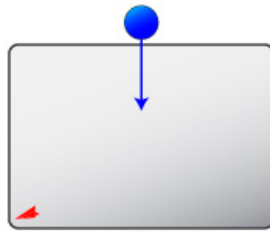

Place finger on the edge and then swipe down from top edge onto the sensitive area of the trackpad. This act will toggle the App commands.

Swipe from Left Edge



Place finger on the edge and then swipe from left edge onto the sensitive area of the trackpad. This act will cycle through previously open or used applications.

Overlay Options

Cirque offers a series of laminate overlays, which provide durable surfaces that are resistant to environmental influences. Depending on your business needs, different materials for overlays may be used. The standard plastic overlay is 0.3 mm thick and the standard glass overlay is 0.7 mm thick. The module settings must be adjusted if an overlay that has different cover materials and thickness is used. Contact Cirque if a different material or thickness is preferred.

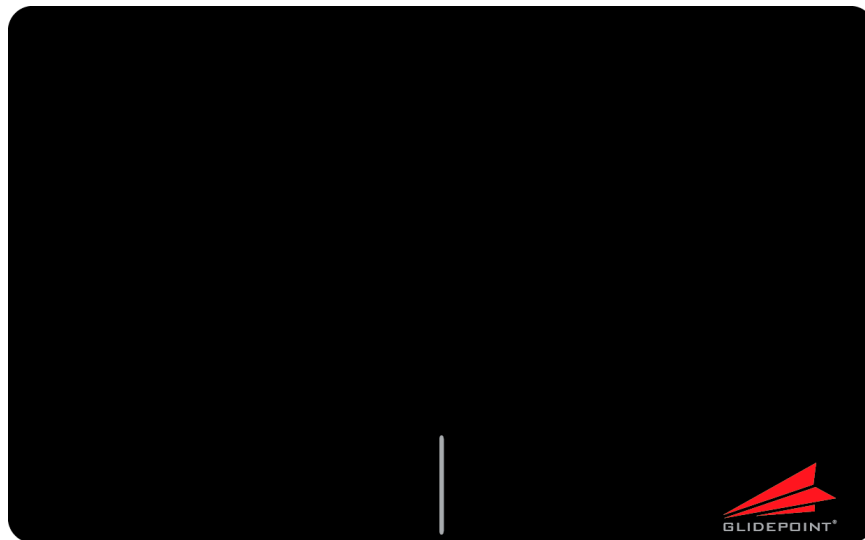

Figure 5. Example Overlay (Scale: NONE)

OEM customers can order a trackpad without an overlay and then purchase their own customized overlay. Custom overlays may include a logo and matching colors. Trackpad functionality is impeded by overlays that use conductive materials (gold, silver, carbon, and so forth); these materials should not be used. Contact Cirque for overlay design guidelines.

Note: Ensure no air gaps remain when adhering an overlay to a trackpad. Air gaps between the trackpad sensing surface and the overlaying surface must be eliminated.

Design Recommendations

Cirque offers the following design recommendations as a guideline for integrating the TM105065-2 trackpad into customer's enclosures.

Implementing the Click Trackpad

Cirque's Click Trackpad is a button-less solution, where the buttons are integrated into the sensor. A button-less trackpad uses a small tactile switch on the Component Side of the module. Pressure on the surface of the trackpad will activate the switch. This act is similar to clicking a mouse. Left button and Right button functions are defined by the location of the finger while clicking.

Button-less trackpads are designed where the trackpad is mounted flush, or just slightly below, the surface of the bezel opening. Cirque recommends this flush design if your product uses Windows 8 Edge Swipe gestures, which requires a finger to be moved from the edge of the bezel opening on to the sensing area of the trackpad.

Bezel Sidewall Thickness

Cirque recommends that the thickness of the bezel opening match the combined thickness of the customer's overlay (plus adhesive) and the trackpad's PCB (see [Figure 2 on page 8](#)).

For more information about overlays and overlay material, see [Overlay Options on page 17](#).

Bezel Opening Geometry

It is recommended that the rectangular shape of the bezel opening have a small offset of approximately 0.5 mm with respect to the perimeter of the trackpad (see [Figure 2 on page 8](#)). Customers are free to use different offsets as long as the trackpad is free to move while clicking.

Conductive Bezel Materials

Conductive materials may be used for the bezel opening; however, they should be connected to the frame ground of the host.

Mounting the Click Trackpad

This section describes a variety of methods for mounting Cirque's Click Trackpads into OEM enclosures.

Mounting Reference Design

The design shown in [Figure 6](#) shows one example for mounting the Click Trackpad.

Note: The Component Area (identified as **COMPONENT AREA KEEP OUT** in the figure below) and the Frame Ground Pad on the Component Side of the trackpad must be kept clear.

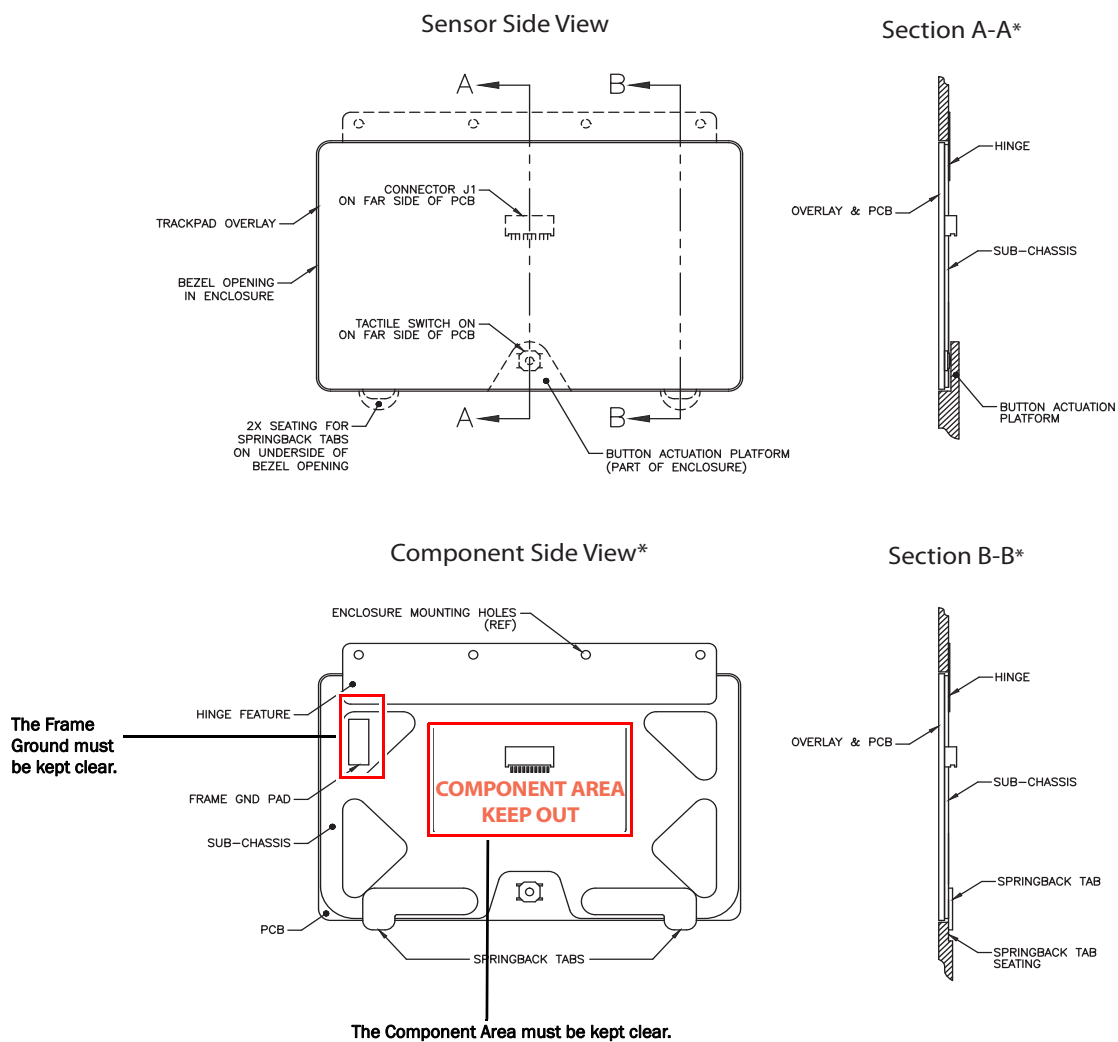

*For clarity, not all of the items are shown in the following views: Section A-A and Section B-B. The enclosure is not shown in the Component Side view.

Figure 6. The TM105065-2 Mounting Reference Design

Mounting Methods

Mounting a button-less trackpad incorporates the following elements:

- [Hinge Feature](#)
- [Button Actuation Platform](#)
- [Spring-Back Tabs](#)
- [Module Sub-Chassis \(Optional\)](#)

Each of these features is described in detail below.

Hinge Feature

Most button-less trackpad designs incorporate a hinge-like feature at the top edge of the PCB (see [Figure 6 on page 19](#)). This hinge may be an actual hinge; or a piece of material (plastic or metal) that attaches to both the Component Side of the module and an adjacent part on the enclosure that is flexible enough that it behaves like a hinge.

Depending on the material selected, the thickness of the material, and the geometry of the hinge element, this hinge feature may significantly increase the amount of force required for switch activation.

Other techniques and designs can be employed to cause the switch to activate. Cirque leaves it to the discretion of the customer's industrial design team to investigate these methods.

Button Actuation Platform

A successful switch activation requires that the stem on the tactile switch engage with a physical platform coincident and opposite of the location of the switch stem (see [Figure 6 on page 19](#)). For manufacturing tolerances, Cirque recommends that customers include a small air gap (0.1 - 0.2 mm) between the switch stem and the actuation platform. This air gap may be minimized during the pre-production phase so that it is not noticeable while the user is clicking the trackpad.

Spring-Back Tabs

Button-less trackpad implementation incorporates industrial designs where the trackpad is mounted flush with, or just slightly below, the near surface of the bezel opening. In order to constrain the trackpad from returning to a position above the surface of the enclosure, two spring-back tabs are recommended (see [Figure 6 on page 19](#)).

Two spring-back tabs are attached to the Component Side of the trackpad PCB and they seat in locations on the underside of the adjacent bezel opening. The spring-back tabs can be either at the lower edge of the module or near the lower edge on the left and right side edges.

The hinge feature and the spring-back tabs may be designed as a single plastic component. If the two spring-back tabs are located along the lower edge, Cirque recommends that these tabs be reasonably separated to prevent the module from twisting when returning to position after switch activation.

Note: *In order for the spring-back tabs to be effective, a slight upward slant in the hinge feature is required to force the tabs to seat properly.*

Module Sub-Chassis (Optional)

A metal sub-chassis that is adhered to the Component Side of the trackpad PCB is useful for integrating the hinge feature and spring-back tabs elements (see [Mounting Reference Design on page 19](#)). The hinge and spring-back tabs should be physically connected to the sub-chassis, either by using mechanical fasteners or by spot welds. Adhesives are not recommended for this purpose. The customer should perform accelerated life testing to establish that the connection points will not fail over time if the design requires adhesives.

Note: *The sub-chassis must be flat and cannot encroach on either the Component Area or the Frame Ground Pad on the Component Side of the trackpad (see [Figure 2 on page 8](#)).*

ESD Protection and EMI Specification

Cirque performs ESD tests at the module level. OEM customers should test and validate ESD performance at each system level. Cirque's ESD tests are based on the IEC61000-4-2 standard, which is a systems-level test specification.

A low impedance path to the frame ground is needed to dissipate inadvertent electrostatic discharges (ESD) to the touch surface of the TM105065-2 trackpad. The 10-pin connector does not provide a path to the host computer's frame ground.

Connecting to the Frame Ground Pad

The TM105065-2 circuit board includes a frame-ground solder pad on the Component Side of the trackpad module ([Figure 2 on page 8](#)). You must incorporate one of the following grounding techniques:

- A suitable drain wire may be soldered directly to the solder pad, which provides a low impedance path to frame ground when properly connected to the host.
- Conductive cloth tape may be used instead of a drain wire. One end of the conductive tape must be adhered to the exposed frame ground pad on the trackpad while the other end must have continuity to the host frame ground.

EMI Susceptibility

Cirque performs Electromagnetic interference (EMI) tests based on the International Electrotechnical Commission (IEC) international standards for radiated and conducted electromagnetic interference.

The TM105065-2 trackpad exhibits low susceptibility to electromagnetic interference in noisy environments. Contact a Cirque OEM sales representative to obtain EMI guidelines and test procedures.

Contact Cirque if you have questions regarding this information.

Contact Information

Contact a Cirque sales representative for a complete list of Cirque's OEM products.

In United States & Canada	(800) GLIDE-75 (454-3375)
Outside US & Canada	(801) 467-1100
Fax	(801) 467-0208
Web site	http://www.cirque.com

Part Ordering Information

When ordering parts, please contact your Cirque representative to assist you in selecting the correct size, power, configurations, and overlay that will best meet your capacitive touch needs.

Part Number

Example: TM105065-2-R04U-0500-10

Table 8. USB Part Number Explanation

Category	Horizontal Size	Vertical Size	Variance	Volt	IC	I/O	Customer Special	Customer Special	Overlay	HW Diff	SW Diff
TM	105 mm	65 mm	2	R= 3 - 5.5 V	04 = Rushmore	U = USB	0	50 Multi	0	1	0

Example: TM105065-2-R04I-0500-10

Table 9. I2C Part Number Explanation

Category	Horizontal Size	Vertical Size	Variance	Volt	IC	I/O	Customer Special	Customer Special	Overlay	HW Diff	SW Diff
TM	105 mm	65 mm	2	R= 3 - 5.5 V	04 = Rushmore	I = I2C	0	50 Multi	0	1	0

THIS INFORMATION IS PROVIDED "AS IS." CIRQUE SPECIFICALLY DISCLAIMS ALL WARRANTIES EXPRESSED OR IMPLIED, INCLUDING BUT NOT LIMITED TO, IMPLIED WARRANTIES OF MERCHANTABILITY AND FITNESS FOR A PARTICULAR PURPOSE WITH RESPECT TO THE DOCUMENTATION AND USE OF THE DOCUMENTATION IN DESIGN OF ANY PRODUCTS OR FOR ANY PARTICULAR APPLICATION.

Mouser Electronics

Authorized Distributor

Click to View Pricing, Inventory, Delivery & Lifecycle Information:

[Cirque:](#)

[DK-000015-00](#)

Компания «Life Electronics» занимается поставками электронных компонентов импортного и отечественного производства от производителей и со складов крупных дистрибьюторов Европы, Америки и Азии.

С конца 2013 года компания активно расширяет линейку поставок компонентов по направлению коаксиальный кабель, кварцевые генераторы и конденсаторы (керамические, пленочные, электролитические), за счёт заключения дистрибьюторских договоров

Мы предлагаем:

- Конкурентоспособные цены и скидки постоянным клиентам.
- Специальные условия для постоянных клиентов.
- Подбор аналогов.
- Поставку компонентов в любых объемах, удовлетворяющих вашим потребностям.
- Приемлемые сроки поставки, возможна ускоренная поставка.
- Доставку товара в любую точку России и стран СНГ.
- Комплексную поставку.
- Работу по проектам и поставку образцов.
- Формирование склада под заказчика.
- Сертификаты соответствия на поставляемую продукцию (по желанию клиента).
- Тестирование поставляемой продукции.
- Поставку компонентов, требующих военную и космическую приемку.
- Входной контроль качества.
- Наличие сертификата ISO.

В составе нашей компании организован Конструкторский отдел, призванный помогать разработчикам, и инженерам.

Конструкторский отдел помогает осуществить:

- Регистрацию проекта у производителя компонентов.
- Техническую поддержку проекта.
- Защиту от снятия компонента с производства.
- Оценку стоимости проекта по компонентам.
- Изготовление тестовой платы монтаж и пусконаладочные работы.



Тел: +7 (812) 336 43 04 (многоканальный)
Email: org@lifeelectronics.ru