

## Overview

The KEMET Tantalum Stacks MnO<sub>2</sub> (TSM) is designed to provide the highest capacitance/voltage ratings in surface mount configuration. KEMET's T493 COTS military/aerospace capacitors are utilized in stacks of 2, 3, 4, and 6 components to achieve a broad range of capacitance and voltage ratings. The T493 COTS offers component level Weibull grading options, surge current testing options and standard, low, and ultra-low ESR options. All component

level lots of this product are conditioned with MIL-PRF-55365 Group A testing. Stacking configurations offer this high reliability product with custom capacitance/voltage solutions and very low ESR options.

*Note: Custom stacking solutions are available with other KEMET Tantalum MnO<sub>2</sub> Surface Mount products. Please contact KEMET Sales for availability.*

## Benefits

- High capacitance
- Surface mountable
- Capacitance values of 9.4 – 2,000 µF
- Capacitance can be custom specified
- Voltage ratings of 6 VDC to 50 VDC
- High volumetric efficiency
- Ultra-low ESR
- Surge capability
- Weibull failure options B and C
- Operating temperature range of -55°C to +125°C
- Laser-marked case
- Discrete components EIA standard case sizes (others available)
- High Temperature lead attach material available (> 260°C)

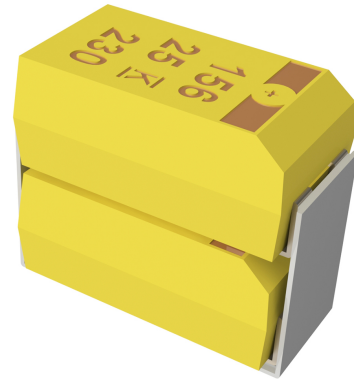

## Applications

Typical applications include decoupling and filtering in a variety of market segments. The T493 COTS stack devices can be utilized in military and aerospace applications. Other KEMET series can be utilized in filtering and decoupling applications to service various market segments.

## Environmental Compliance

RoHS Compliant (6/6) according to Directive 2002/95/EC when ordered with 100% Sn solder.

## K-SIM

For a detailed analysis of specific part numbers, please visit [ksim.kemet.com](http://ksim.kemet.com) to access KEMET's K-SIM software. KEMET K-SIM is designed to simulate behavior of components with respect to frequency, ambient temperature, and DC bias levels.

## Ordering Information

T	SM	2D	447	K	10	A	H	61	20	D493
Capacitor Class	Series	Case Size	Capacitance Code (pF)	Capacitance Tolerance	Rated Voltage (VDC)	Failure Rate/ Design	Termination Finish	Surge	ESR	C-Spec 2
T = Tantalum	Stacks MnO <sub>2</sub> cathode	2C, 3C, 4C, 6C, 2D, 3D, 4D, 6D, 2X, 3X, 4X, 6X	First two digits represent significant figures. Third digit specifies number of zeros.	K = ±10% M = ±20%	006 = 6.3 010 = 10 016 = 16 020 = 20 025 = 25 035 = 35 050 = 50	A = N/A B = 0.1%/1,000 hours C = 0.01%/1,000 hours	H = Standard solder-coated (SnPb 5% Pb minimum) C = Hot solder dipped B = Gold-plated T = 100% Tin	61 = None 62 = 10 Cycles 25°C after Weibull 63 = 10 cycles, -55°C and 85°C after Weibull 64 = 10 cycles, -55°C and 85°C before Weibull	10 = ESR - standard 20 = ESR - low 30 = ESR - ultra-low	First digit represents outer leadframe finish D = Silver-plated (Ag) H = Solder-plated (SnPb 5% Pb minimum) T = 100% Tin (Sn) Second, third, and fourth digit designates discrete component series. 493 = T493

Note: Custom discrete component stacking solutions are also available with other KEMET Polymer Electrolytic Surface Mount series/products. Please contact KEMET Sales for availability.

## Performance Characteristics

Item	Performance Characteristics
Operating Temperature	-55°C to 125°C
Rated Capacitance Range	9.4 – 2,000 µF at 120 Hz/25°C
Capacitance Tolerance	K Tolerance (10%), M Tolerance (20%)
Rated Voltage Range	6 – 50 V
DF (120 Hz)	Refer to Part Number Electrical Specification Table
ESR (100 kHz)	Refer to Part Number Electrical Specification Table
Leakage Current	≤ 0.01 CV (µA) at rated voltage after 5 minutes

## Qualification

Test	Condition	Characteristics	
Endurance	85°C at rated voltage, 2,000 hours 125°C at 2/3 rated voltage, 2,000 hours	Δ C/C	Within ±10% of initial value
		DF	Within initial limits
		DCL	Within 1.25 x initial limit
		ESR	Within initial limits
Thermal Shock	KEMET specified test, mounted, -55°C to 125°C, 5 cycles	Δ C/C	Within ±5% of initial value
		DF	Within initial limits
		DCL	Within 1.25 x initial limit
		ESR	Within initial limits
Surge Voltage	85°C, 1.15 x rated voltage 1,000 cycles	Δ C/C	Within ±5% of initial value
		DF	Within initial limits
		DCL	Within initial limits
		ESR	Within initial limits
Surge Voltage	125°C, 0.77 x rated voltage 1,000 cycles	Δ C/C	Within ±5% of initial value
		DF	Within initial limits
		DCL	Within initial limits
		ESR	Within initial limits
Mechanical Vibration	MIL-STD-202, Method 204, Condition D, 10 Hz to 2,000 Hz, 20 G peak	Δ C/C	Within ±10% of initial value
		DF	Within initial limits
		DCL	Within initial limits

## Dimensions – Millimeters (Inches)

Metric will govern

### TSM2

KEMET 2 Component Stack Dimensions						
Case Code	L	W	H	W <sub>2</sub>	H <sub>2</sub>	P
2C	6.5±0.38 (0.258±0.015)	3.3±0.2 (0.130±0.008)	5.3±0.38 (0.210±0.015)	2.5±0.2 (0.100±0.008)	4.5±0.38 (0.176±0.015)	1.4±0.38 (0.055±0.015)
2D	8.0±0.38 (0.315±0.015)	4.4±0.2 (0.174±0.008)	6.2±0.38 (0.245±0.015)	3.0±0.2 (0.120±0.008)	4.8±0.38 (0.192±0.015)	1.9±.38 (0.075±0.015)
2X	8.0±0.38 (0.315±0.015)	4.4±0.2 (0.174±0.008)	8.9±0.38 (0.352±0.015)	3.0±0.2 (0.120±0.008)	6.9±0.38 (0.272±0.015)	1.9±0.38 (0.075±0.015)

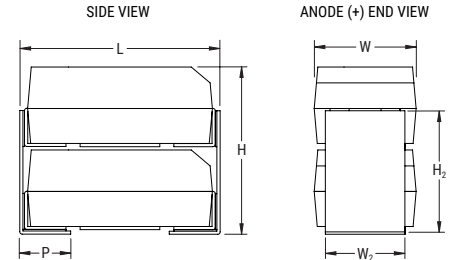

### TSM3

KEMET 3 Component Stack Dimensions						
Case Code	L	W	H	W <sub>2</sub>	H <sub>2</sub>	P
3C	6.5±0.38 (0.258±0.015)	3.3±0.2 (0.130±0.008)	7.8±0.38 (0.310±0.015)	2.5±0.2 (0.100±0.008)	6.4±0.38 (0.252±0.015)	1.4±0.38 (0.055±0.015)
3D	8.0±0.38 (0.315±0.015)	4.4±0.2 (0.174±0.008)	9.2±0.38 (0.365±0.015)	3.0±0.2 (0.120±0.008)	7.7±0.38 (0.304±0.015)	1.9±0.38 (0.075±0.015)
3X	8.0±0.38 (0.315±0.015)	4.4±0.2 (0.174±0.008)	13.3±0.38 (0.525±0.015)	3.0±0.2 (0.120±0.008)	11.0±0.38 (0.436±0.015)	1.9±0.38 (0.075±0.015)

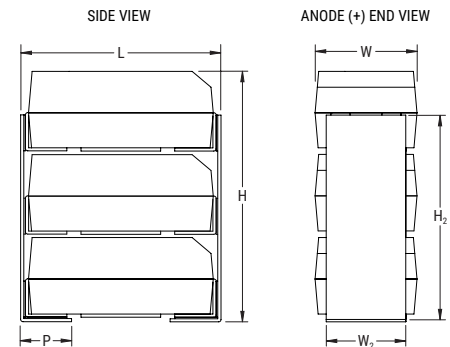

### TSM4

KEMET 4 Component Stack Dimensions						
Case Code	L	W	H	W <sub>2</sub>	H <sub>2</sub>	P
4C	6.5±0.38 (0.258±0.015)	6.6±0.2 (0.262±0.008)	5.3±0.38 (0.210±0.015)	5.8±0.2 (0.230±0.008)	4.6±0.38 (0.180±0.015)	1.4±0.38 (0.055±0.015)
4D	8.0±0.38 (0.315±0.015)	8.9±0.2 (0.350±0.008)	6.2±0.38 (0.245±0.015)	7.4±0.2 (0.292±0.008)	4.8±0.38 (0.192±0.015)	1.9±0.38 (0.075±0.015)
4X	8.0±0.38 (0.315±0.015)	8.9±0.2 (0.350±0.008)	8.9±0.38 (0.352±0.015)	7.4±0.2 (0.292±0.008)	6.9±0.38 (0.272±0.015)	1.9±0.38 (0.075±0.015)

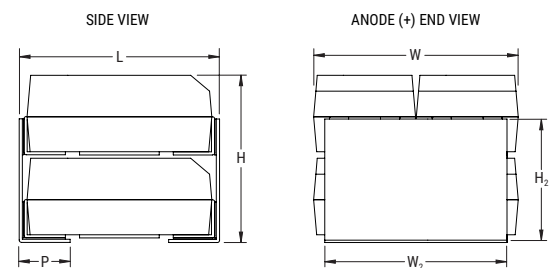

### TSM6

KEMET 6 Component Stack Dimensions						
Case Code	L	W	H	W <sub>2</sub>	H <sub>2</sub>	P
6C	6.5±0.38 (0.258±0.015)	6.6±0.2 (0.262±0.008)	7.8±0.38 (0.310±0.015)	5.8±0.2 (0.230±0.008)	6.6±0.38 (0.260±0.015)	1.4±0.38 (.055±0.015)
6D	8.0±0.38 (0.315±0.015)	8.9±0.2 (0.350±0.008)	9.2±0.38 (0.365±0.015)	7.4±0.2 (0.292±0.008)	7.7±0.38 (0.304±0.015)	1.9±0.38 (0.075±0.015)
6X	8.0±0.38 (0.315±0.015)	8.9±0.2 (0.350±0.008)	13.3±0.38 (0.525±0.015)	7.4±0.2 (0.292±0.008)	11.0±0.38 (0.436±0.015)	1.9±0.38 (0.075±0.015)

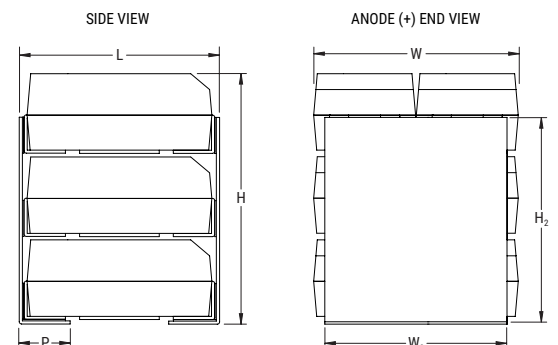

## Capacitance & Rated Voltage Chart

Capacitance		Rated Voltage						
µF	Code	6 V	10 V	16 V	20 V	25 V	35 V	50 V
9.4	945							2D
14	146							3D
19	196							4D
20	206						2C	2X
28	286							6D
30	306					2C	3C	3X
40	406						4C	4X
44	446				2C		2D	
45	456					3C		
60	606					4C	6C	6X
66	666				3C		3D	
88	886				4C		4D	
90	906					6C		
94	946			2C		2D		
130	137				6C, 2D		6D	
140	147			3C		3D		
190	197			4C		4D		
200	207		2C		3D			
270	277				4D			
280	287			6C		6D		
300	307		3C	2D				
400	407		4C					
410	417				6D			
440	447	2C	2D					
450	457			3D				
600	607		6C	4D				
660	667	3C, 2D	3D, 2X					
880	887	4C	4D					
900	907			6D				
990	997	3D	3X					
1300	138	6C, 4D	6D, 4X					
2000	208	6D	6X					

**Table 1A – TSM2 Ratings & Part Number Reference**

Rated Voltage	Rated Capacitance	Case Code/ Case Size	KEMET Part Number	DC Leakage	DF	Standard ESR	Low ESR	Ultra-low ESR	Maximum Operating Temp	MSL
VDC @ 85°C	µF	KEMET/EIA	(See below for part options)	µA @ +20°C Maximum/ 5 Minutes	% @ +20°C 120 Hz Maximum	Ω @ 20°C 100 kHz Maximum	Ω @ 20°C 100 kHz Maximum	Ω @ 20°C 100 kHz Maximum	°C	Reflow Temp ≤ 260°C
6.3	440	2C	TSM2C447(1)006(2)(3)(4)(5)	27.8	10	0.600	0.150	0.120	125	1
10	200	2C	TSM2C207(1)010(2)(3)(4)(5)	20.0	8	0.600	0.150	NA	125	1
16	94	2C	TSM2C946(1)016(2)(3)(4)(5)	15.0	6	0.600	0.250	0.175	125	1
20	44	2C	TSM2C446(1)020(2)(3)(4)(5)	8.8	6	0.600	0.200	NA	125	1
25	30	2C	TSM2C306(1)025(2)(3)(4)(5)	7.6	6	0.750	0.450	NA	125	1
35	20	2C	TSM2C206(1)035(2)(3)(4)(5)	7.0	6	1.000	0.600	NA	125	1
6.3	660	2D	TSM2D667(1)006(2)(3)(4)(5)	41.6	8	0.250	0.075	0.050	125	1
10	440	2D	TSM2D447(1)010(2)(3)(4)(5)	44.0	8	0.250	0.100	0.040	125	1
16	300	2D	TSM2D307(1)016(2)(3)(4)(5)	48.0	8	0.350	0.200	0.075	125	1
20	130	2D	TSM2D137(1)020(2)(3)(4)(5)	27.2	8	0.350	0.100	0.075	125	1
25	94	2D	TSM2D946(1)025(2)(3)(4)(5)	23.6	10	0.350	0.100	0.060	125	1
35	44	2D	TSM2D446(1)035(2)(3)(4)(5)	15.4	6	0.350	0.200	0.100	125	1
50	9.4	2D	TSM2D945(1)050(2)(3)(4)(5)	4.8	6	0.750	0.300	0.140	125	1
10	660	2X	TSM2X667(1)010(2)(3)(4)(5)	66.0	10	0.250	0.050	0.025	125	1
50	20	2X	TSM2X206(1)050(2)(3)(4)(5)	10.0	6	0.350	0.200	NA	125	1

**Table 1B – TSM3 Ratings & Part Number Reference**

Rated Voltage	Rated Capacitance	Case Code/ Case Size	KEMET Part Number	DC Leakage	DF	Standard ESR	Low ESR	Ultra-low ESR	Maximum Operating Temp	MSL
VDC @ 85°C	µF	KEMET/EIA	(See below for part options)	µA @ +20°C Maximum/ 5 Minutes	% @ +20°C 120 Hz Maximum	Ω @ 20°C 100 kHz Maximum	Ω @ 20°C 100 kHz Maximum	Ω @ 20°C 100 kHz Maximum	°C	Reflow Temp ≤ 260°C
6.3	660	3C	TSM3C667(1)006(2)(3)(4)(5)	41.7	10	0.400	0.100	0.077	125	1
10	300	3C	TSM3C307(1)010(2)(3)(4)(5)	30.0	8	0.400	0.100	NA	125	1
16	140	3C	TSM3C147(1)016(2)(3)(4)(5)	22.5	6	0.400	0.167	0.117	125	1
20	66	3C	TSM3C666(1)020(2)(3)(4)(5)	13.2	6	0.400	0.133	NA	125	1
25	45	3C	TSM3C456(1)025(2)(3)(4)(5)	11.4	6	0.500	0.300	NA	125	1
35	30	3C	TSM3C306(1)035(2)(3)(4)(5)	10.5	6	0.667	0.400	NA	125	1
6.3	990	3D	TSM3D997(1)006(2)(3)(4)(5)	62.4	8	0.167	0.050	0.033	125	1
10	660	3D	TSM3D667(1)010(2)(3)(4)(5)	66.0	8	0.167	0.067	0.027	125	1
16	450	3D	TSM3D457(1)016(2)(3)(4)(5)	72.0	8	0.233	0.133	0.050	125	1
20	200	3D	TSM3D207(1)020(2)(3)(4)(5)	40.8	8	0.233	0.067	0.050	125	1
25	140	3D	TSM3D147(1)025(2)(3)(4)(5)	35.4	10	0.233	0.067	0.040	125	1
35	66	3D	TSM3D666(1)035(2)(3)(4)(5)	23.1	6	0.233	0.133	0.067	125	1
50	14	3D	TSM3D146(1)050(2)(3)(4)(5)	7.2	6	0.500	0.200	0.093	125	1
10	990	3X	TSM3X997(1)010(2)(3)(4)(5)	99.0	10	0.167	0.033	0.017	125	1
50	30	3X	TSM3X306(1)050(2)(3)(4)(5)	15.0	6	0.233	0.133	NA	125	1

(1) To complete KEMET part number, insert M for ± 20%, K for ± 10%. Designates Capacitance tolerance.

(2) To complete KEMET part number, insert B (0.1%/1,000 hours), C (0.01%/1,000 hours) or A = N/A. Designates Reliability Level.

(3) To complete KEMET part number, insert B = Gold Plated, C = Hot solder dipped, H = Solder Plated, or T = 100% Tin (Sn). Designates Termination Finish.

(4) To complete KEMET part number, insert 61 = None, 62 = 10 cycles +25°C, 63 = 10 cycles -55°C +85°C after Weibull or 64 = 10 cycles -55°C +85°C before Weibull. Designates Surge current option.

(5) To complete KEMET part number, insert 10 = Standard ESR, 20 = Low ESR or 30 = Ultra Low ESR. Designates ESR option. Refer to Ordering Information for additional detail.

**Table 1C – TSM4 Ratings & Part Number Reference**

Rated Voltage	Rated Capacitance	Case Code/ Case Size	KEMET Part Number	DC Leakage	DF	Standard ESR	Low ESR	Ultra-low ESR	Maximum Operating Temp	MSL
VDC @ 85°C	µF	KEMET/EIA	(See below for part options)	µA @ +20°C Maximum/ 5 Minutes	% @ +20°C 120 Hz Maximum	Ω @ 20°C 100 kHz Maximum	Ω @ 20°C 100 kHz Maximum	Ω @ 20°C 100 kHz Maximum	°C	Reflow Temp ≤ 260°C
6.3	880	4C	TSM4C887(1)006(2)(3)(4)(5)	55.6	10	0.300	0.075	0.058	125	1
10	400	4C	TSM4C407(1)010(2)(3)(4)(5)	40.0	8	0.300	0.075	NA	125	1
16	190	4C	TSM4C197(1)016(2)(3)(4)(5)	30.0	6	0.300	0.125	0.088	125	1
20	88	4C	TSM4C886(1)020(2)(3)(4)(5)	17.6	6	0.300	0.100	NA	125	1
25	60	4C	TSM4C606(1)025(2)(3)(4)(5)	15.2	6	0.375	0.225	NA	125	1
35	40	4C	TSM4C406(1)035(2)(3)(4)(5)	14.0	6	0.500	0.300	NA	125	1
6.3	1300	4D	TSM4D138(1)006(2)(3)(4)(5)	83.2	8	0.125	0.038	0.025	125	1
10	880	4D	TSM4D887(1)010(2)(3)(4)(5)	88.0	8	0.125	0.050	0.020	125	1
16	600	4D	TSM4D607(1)016(2)(3)(4)(5)	96.0	8	0.175	0.100	0.038	125	1
20	270	4D	TSM4D277(1)020(2)(3)(4)(5)	54.4	8	0.175	0.050	0.038	125	1
25	180	4D	TSM4D187(1)025(2)(3)(4)(5)	47.2	10	0.175	0.050	0.030	125	1
35	88	4D	TSM4D886(1)035(2)(3)(4)(5)	30.8	6	0.175	0.100	0.050	125	1
50	19	4D	TSM4D196(1)050(2)(3)(4)(5)	9.6	6	0.375	0.150	0.070	125	1
10	1300	4X	TSM4X138(1)010(2)(3)(4)(5)	132.0	10	0.125	0.025	0.013	125	1
50	40	4X	TSM4X406(1)050(2)(3)(4)(5)	20.0	6	0.175	0.100	NA	125	1

**Table 1D – TSM6 Ratings & Part Number Reference**

Rated Voltage	Rated Capacitance	Case Code/ Case Size	KEMET Part Number	DC Leakage	DF	Standard ESR	Low ESR	Ultra-low ESR	Maximum Operating Temp	MSL
VDC @ 85°C	µF	KEMET/EIA	(See below for part options)	µA @ +20°C Maximum/ 5 Minutes	% @ +20°C 120 Hz Maximum	Ω @ 20°C 100 kHz Maximum	Ω @ 20°C 100 kHz Maximum	Ω @ 20°C 100 kHz Maximum	°C	Reflow Temp ≤ 260°C
6.3	1300	6C	TSM6C138(1)006(2)(3)(4)(5)	83.4	10	0.200	0.050	0.038	125	1
10	600	6C	TSM6C607(1)010(2)(3)(4)(5)	60.0	8	0.200	0.050	NA	125	1
16	280	6C	TSM6C287(1)016(2)(3)(4)(5)	45.0	6	0.200	0.083	0.058	125	1
20	130	6C	TSM6C137(1)020(2)(3)(4)(5)	26.4	6	0.200	0.067	NA	125	1
25	90	6C	TSM6C906(1)025(2)(3)(4)(5)	22.8	6	0.250	0.150	NA	125	1
35	60	6C	TSM6C606(1)035(2)(3)(4)(5)	21.0	6	0.333	0.200	NA	125	1
6.3	2000	6D	TSM6D208(1)006(2)(3)(4)(5)	124.8	8	0.083	0.025	0.017	125	1
10	1300	6D	TSM6D138(1)010(2)(3)(4)(5)	132.0	8	0.083	0.033	0.013	125	1
16	900	6D	TSM6D907(1)016(2)(3)(4)(5)	144.0	8	0.117	0.067	0.025	125	1
20	410	6D	TSM6D417(1)020(2)(3)(4)(5)	81.6	8	0.117	0.033	0.025	125	1
25	280	6D	TSM6D287(1)025(2)(3)(4)(5)	70.8	10	0.117	0.033	0.020	125	1
35	130	6D	TSM6D137(1)035(2)(3)(4)(5)	46.2	6	0.117	0.067	0.033	125	1
50	28	6D	TSM6D286(1)050(2)(3)(4)(5)	14.4	6	0.250	0.100	0.047	125	1
10	2000	6X	TSM6X208(1)010(2)(3)(4)(5)	198.0	10	0.083	0.017	0.008	125	1
50	60	6X	TSM6X606(1)050(2)(3)(4)(5)	30.0	6	0.117	0.067	NA	125	1

1) To complete KEMET part number, insert M for ± 20%, K for ± 10%. Designates Capacitance tolerance.

2) To complete KEMET part number, insert B (0.1%/1,000 hours), C (0.01%/1,000 hours) or A = N/A. Designates Reliability Level.

3) To complete KEMET part number, insert B = Gold Plated, C = Hot solder dipped, H = Solder Plated, or T = 100% Tin (Sn). Designates Termination Finish.

4) To complete KEMET part number, insert 61 = None, 62 = 10 cycles +25°C, 63 = 10 cycles -55°C +85°C after Weibull or 64 = 10 cycles -55°C +85°C before Weibull. Designates Surge current option.

5) To complete KEMET part number, insert 10 = Standard ESR, 20 = Low ESR or 30 = Ultra Low ESR. Designates ESR option.

Refer to Ordering Information for additional detail.

## Recommended Voltage Derating Guidelines

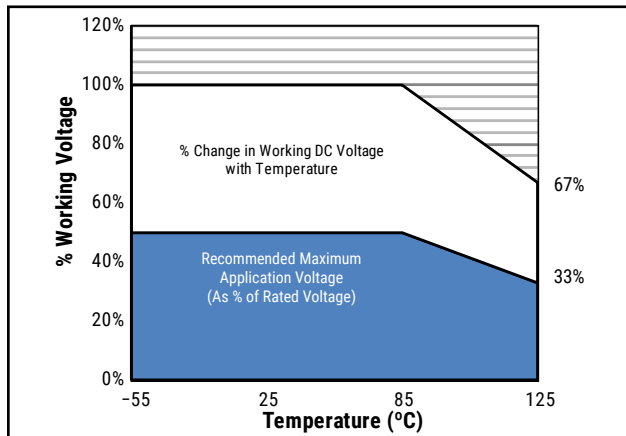

## Reverse Voltage

Solid tantalum capacitors are polar devices and may be permanently damaged or destroyed if connected with the wrong polarity. The positive terminal is identified on the capacitor body by a stripe plus in some cases a beveled edge. A small degree of transient reverse voltage is permissible for short periods per the table. The capacitors should not be operated continuously in reverse mode, even within these limits.

Temperature	Permissible Transient Reverse Voltage
25°C	15% of Rated Voltage
85°C	5% of Rated Voltage
125°C	1% of Rated Voltage



**Table 2 – Land Dimensions/Courtyard**

KEMET	Density Level A: Maximum (Most) Land Protrusion (mm)					Density Level B: Median (Nominal) Land Protrusion (mm)					Density Level C: Minimum (Least) Land Protrusion (mm)				
	Case	L	W	S	V1	V2	L	W	S	V1	V2	L	W	S	V1
TSM2C	2.98	2.74	2.53	9.50	4.50	2.58	2.62	2.73	8.40	4.00	2.20	2.52	2.89	7.54	3.74
TSM2D	3.48	3.24	3.03	11.00	5.60	3.08	3.12	3.23	9.90	5.10	2.70	3.02	3.39	9.04	4.84
TSM2X	3.48	3.24	3.03	11.00	5.60	3.08	3.12	3.23	9.90	5.10	2.70	3.02	3.39	9.04	4.84
TSM3C	2.98	2.74	2.53	9.50	4.50	2.58	2.62	2.73	8.40	4.00	2.20	2.52	2.89	7.54	3.74
TSM3D	3.48	3.24	3.03	11.00	5.60	3.08	3.12	3.23	9.90	5.10	2.70	3.02	3.39	9.04	4.84
TSM3X	3.48	3.24	3.03	11.00	5.60	3.08	3.12	3.23	9.90	5.10	2.70	3.02	3.39	9.04	4.84
TSM4C	2.98	6.04	2.53	9.50	7.80	2.58	5.92	2.73	8.40	7.30	2.20	5.82	2.89	7.54	7.04
TSM4D	3.48	7.64	3.03	11.00	10.10	3.08	7.52	3.23	9.90	9.60	2.70	7.42	3.39	9.04	9.34
TSM4X	3.48	7.64	3.03	11.00	10.10	3.08	7.52	3.23	9.90	9.60	2.70	7.42	3.39	9.04	9.34
TSM6C	2.98	6.04	2.53	9.50	7.80	2.58	5.92	2.73	8.40	7.30	2.20	5.82	2.89	7.54	7.04
TSM6D	3.48	7.64	3.03	11.00	10.10	3.08	7.52	3.23	9.90	9.60	2.70	7.42	3.39	9.04	9.34
TSM6X	3.48	7.64	3.03	11.00	10.10	3.08	7.52	3.23	9.90	9.60	2.70	7.42	3.39	9.04	9.34

**Density Level A:** For low-density Product applications. Recommended for wave solder applications and provides a wider process window for reflow solder processes.

**Density Level B:** For products with a moderate level of component density. Provides a robust solder attachment condition for reflow solder processes.

**Density Level C:** For high component density product applications. Before adapting the minimum land pattern variations the user should perform qualification testing based on the conditions outlined in IPC standard 7351 (IPC-7351).

<sup>1</sup> Height of these chips may create problems in wave soldering.

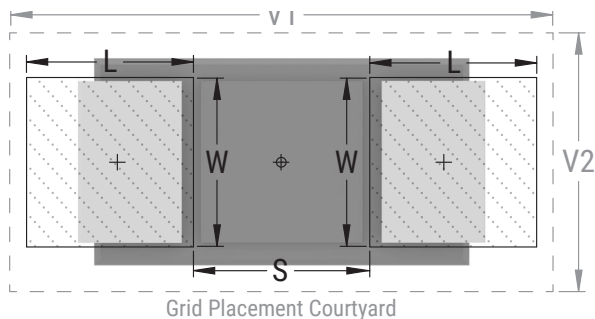

## Soldering Process

KEMET’s families of surface mount capacitors are compatible with wave (single or dual), convection, IR, or vapor phase reflow techniques. Preheating of these components is recommended to avoid extreme thermal stress. KEMET’s recommended profile conditions for convection and IR reflow reflect the profile conditions of the IPC/J–STD–020D standard for moisture sensitivity testing. The devices can safely withstand a maximum of three reflow passes at these conditions.

Please note that although the X/7343–43 case size can withstand wave soldering, the tall profile (4.3 mm maximum) dictates care in wave process development.

Hand soldering should be performed with care due to the difficulty in process control. If performed, care should be taken to avoid contact of the soldering iron to the molded case. The iron should be used to heat the solder pad, applying solder between the pad and the termination, until reflow occurs. Once reflow occurs, the iron should be removed immediately. “Wiping” the edges of a chip and heating the top surface is not recommended.

During typical reflow operations, a slight darkening of the gold-colored epoxy may be observed. This slight darkening is normal and not harmful to the product. Marking permanency is not affected by this change.

Profile Feature	SnPb Assembly	Pb-Free Assembly
Preheat/Soak		
Temperature Minimum ( $T_{smin}$ )	100°C	150°C
Temperature Maximum ( $T_{smax}$ )	150°C	200°C
Time ( $t_s$ ) from $T_{smin}$ to $T_{smax}$	60 – 120 seconds	60 – 120 seconds
Ramp-up Rate ( $T_L$ to $T_p$ )	3°C/seconds maximum	3°C/seconds maximum
Liquidous Temperature ( $T_L$ )	183°C	217°C
Time Above Liquidous ( $t_L$ )	60 – 150 seconds	60 – 150 seconds
Peak Temperature ( $T_p$ )	220°C*	250°C*
Time within 5°C of Maximum Peak Temperature ( $t_p$ )	20 seconds maximum	30 seconds maximum
Ramp-down Rate ( $T_p$ to $T_L$ )	6°C/seconds maximum	6°C/seconds maximum
Time 25°C to Peak Temperature	6 minutes maximum	8 minutes maximum

Note: All temperatures refer to the center of the package, measured on the package body surface that is facing up during assembly reflow.

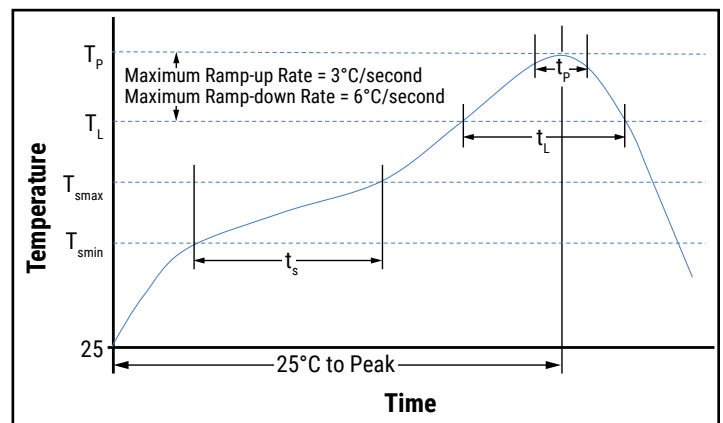

## Storage

Tantalum chip capacitors should be stored in normal working environments. While the chips themselves are quite robust in other environments, solderability will be degraded by exposure to high temperatures, high humidity, corrosive atmospheres, and long term storage. In addition, packaging materials will be degraded by high temperature – reels may soften or warp and tape peel force may increase. KEMET recommends that maximum storage temperature not exceed 40°C and maximum storage humidity not exceed 60% relative humidity. Temperature fluctuations should be minimized to avoid condensation on the parts and atmospheres should be free of chlorine and sulphur bearing compounds. For optimized solderability chip stock should be used promptly, preferably within three years of receipt.

## Construction

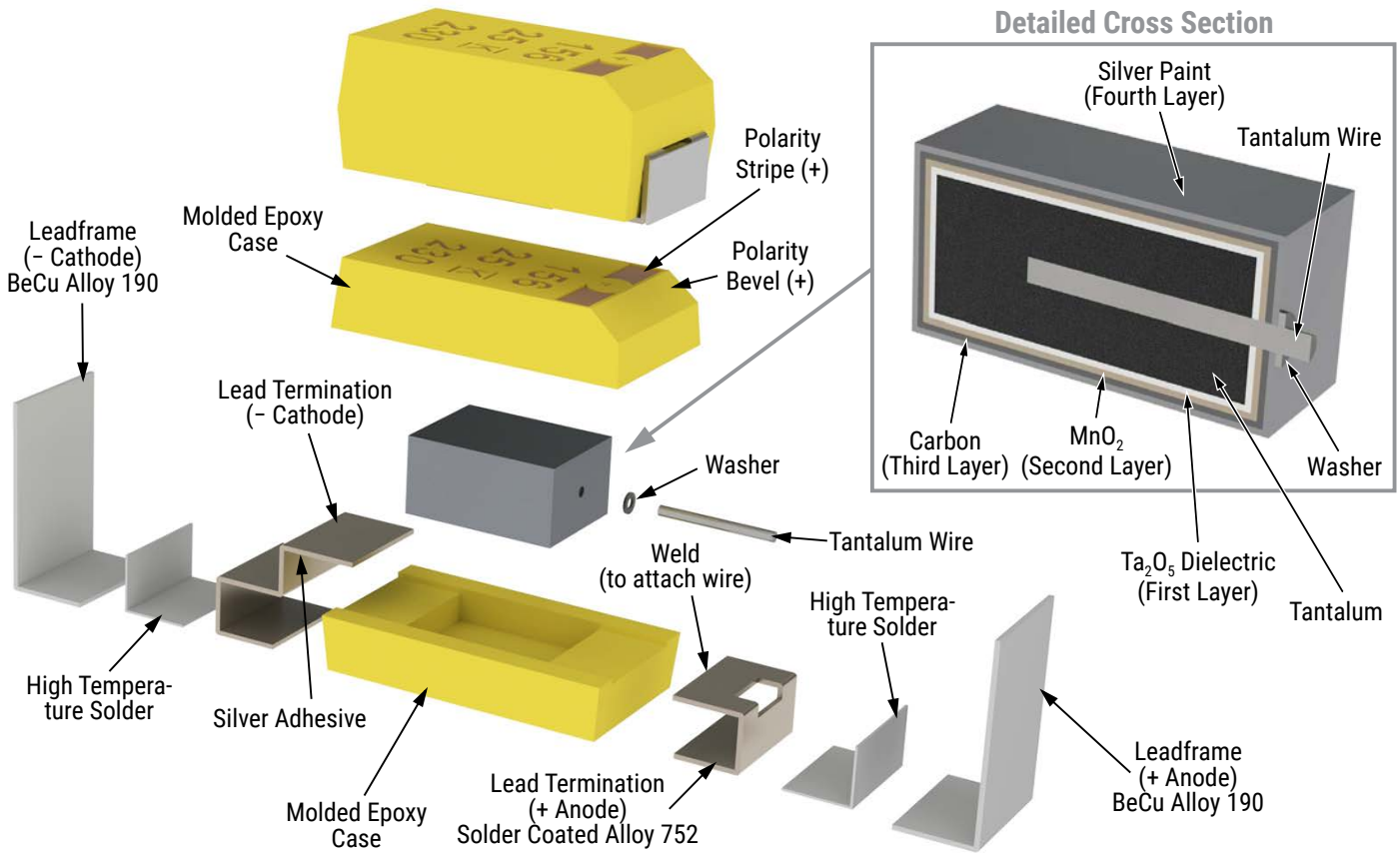

## Capacitor Marking

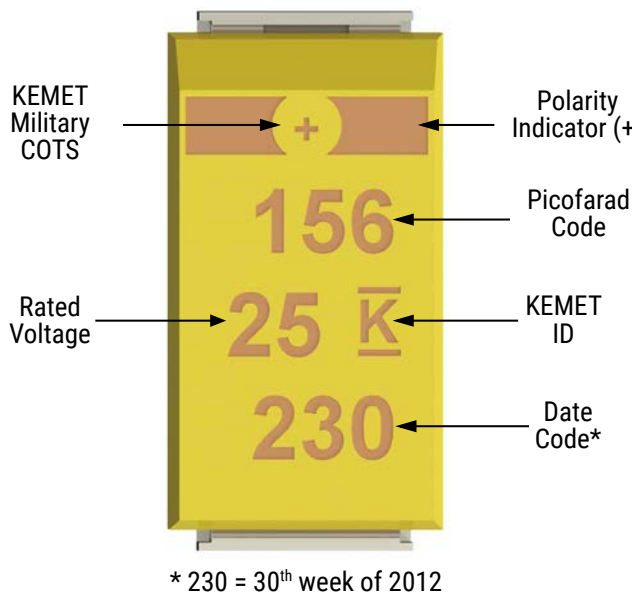

Date Code *	
1 <sup>st</sup> digit = Last number of Year	2 = 2012 3 = 2013 4 = 2014 5 = 2015 6 = 2016 7 = 2017
2 <sup>nd</sup> and 3 <sup>rd</sup> digit = Week of the Year	01 = 1 <sup>st</sup> week of the Year to 52 = 52 <sup>nd</sup> week of the Year

## KEMET Electronics Corporation Sales Offices

For a complete list of our global sales offices, please visit [www.kemet.com/sales](http://www.kemet.com/sales).

---

### Disclaimer

All product specifications, statements, information and data (collectively, the "Information") in this datasheet are subject to change. The customer is responsible for checking and verifying the extent to which the Information contained in this publication is applicable to an order at the time the order is placed. All Information given herein is believed to be accurate and reliable, but it is presented without guarantee, warranty, or responsibility of any kind, expressed or implied.

Statements of suitability for certain applications are based on KEMET Electronics Corporation's ("KEMET") knowledge of typical operating conditions for such applications, but are not intended to constitute – and KEMET specifically disclaims – any warranty concerning suitability for a specific customer application or use. The Information is intended for use only by customers who have the requisite experience and capability to determine the correct products for their application. Any technical advice inferred from this Information or otherwise provided by KEMET with reference to the use of KEMET's products is given gratis, and KEMET assumes no obligation or liability for the advice given or results obtained.

Although KEMET designs and manufactures its products to the most stringent quality and safety standards, given the current state of the art, isolated component failures may still occur. Accordingly, customer applications which require a high degree of reliability or safety should employ suitable designs or other safeguards (such as installation of protective circuitry or redundancies) in order to ensure that the failure of an electrical component does not result in a risk of personal injury or property damage.

Although all product-related warnings, cautions and notes must be observed, the customer should not assume that all safety measures are indicated or that other measures may not be required.

*KEMET is a registered trademark of KEMET Electronics Corporation.*

Компания «Life Electronics» занимается поставками электронных компонентов импортного и отечественного производства от производителей и со складов крупных дистрибьюторов Европы, Америки и Азии.

С конца 2013 года компания активно расширяет линейку поставок компонентов по направлению коаксиальный кабель, кварцевые генераторы и конденсаторы (керамические, пленочные, электролитические), за счёт заключения дистрибьюторских договоров

Мы предлагаем:

- Конкурентоспособные цены и скидки постоянным клиентам.
- Специальные условия для постоянных клиентов.
- Подбор аналогов.
- Поставку компонентов в любых объемах, удовлетворяющих вашим потребностям.
- Приемлемые сроки поставки, возможна ускоренная поставка.
- Доставку товара в любую точку России и стран СНГ.
- Комплексную поставку.
- Работу по проектам и поставку образцов.
- Формирование склада под заказчика.
- Сертификаты соответствия на поставляемую продукцию (по желанию клиента).
- Тестирование поставляемой продукции.
- Поставку компонентов, требующих военную и космическую приемку.
- Входной контроль качества.
- Наличие сертификата ISO.

В составе нашей компании организован Конструкторский отдел, призванный помогать разработчикам, и инженерам.

Конструкторский отдел помогает осуществить:

- Регистрацию проекта у производителя компонентов.
- Техническую поддержку проекта.
- Защиту от снятия компонента с производства.
- Оценку стоимости проекта по компонентам.
- Изготовление тестовой платы монтаж и пусконаладочные работы.



Тел: +7 (812) 336 43 04 (многоканальный)  
Email: [org@lifeelectronics.ru](mailto:org@lifeelectronics.ru)