

# FDG901D

## Slew Rate Control IC for P-Channel MOSFETs

### Features

- Three Programmable Slew Rates
- Reduces Inrush Current
- Minimizes EMI
- Normal Turn-Off Speed
- Low-Power CMOS Operates Over Wide Voltage Range
- Compact Industry Standard SC70-5 Surface Mount Package
- RoHS Compliant

### Applications

- Battery Load switch
- Power management



### General Description

The FDG901D is specifically designed to control the turn on of a P-Channel MOSFET in order to limit the inrush current in battery switching applications with high capacitance loads. During turn-on, the FDG901D drives the MOSFET's gate low with a regulated current source, thereby controlling the MOSFET's turn on. For turn-off, the IC pulls the MOSFET gate up quickly for efficient turn off.

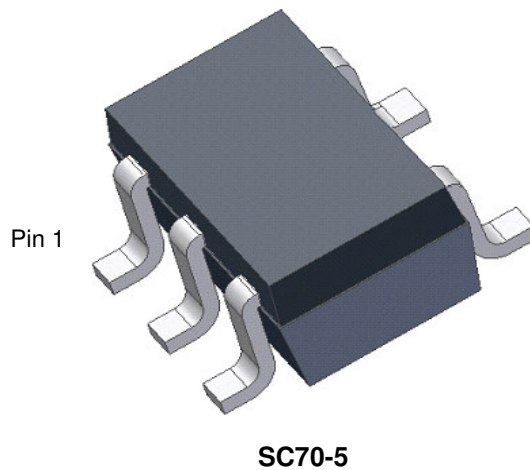

### Package Marking and Ordering Information

Device Marking	Device	Reel Size	Tape Width	Quantity
91	FDG901D	7"	8mm	3000 units

## Pin Configuration

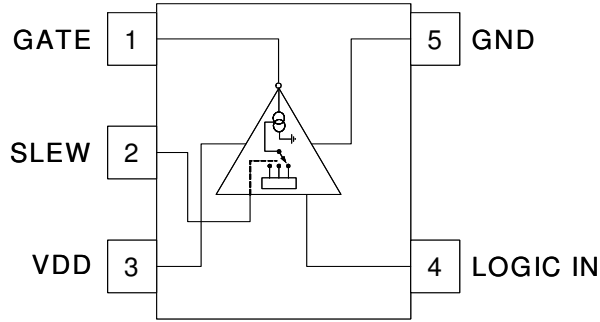

## Absolute Maximum Ratings

Parameter	Min.	Max.	Unit
Supply Voltage	-0.5	10	V
DC Input Voltage (Logic Inputs)	-0.7	9	V
Power Dissipation for Single Operation @ 85°C		150	mW
Operating and Storage Junction Temperature	-65	150	°C
Thermal Resistance, Junction to Ambient (note 1)		425	°C/W

## Recommended Operating Range

Parameter	Min.	Max.	Unit
Supply Voltage	2.7	6	V
Operating Junction Temperature	-40	150	°C

## Electrical Characteristics

$T_A = 25^\circ\text{C}$  unless otherwise noted

Parameter	Symbol	Conditions	Min.	Typ.	Max.	Units	
<b>Logic Levels</b>							
Logic High Input Voltage	$V_{IH}$	$V_{DD} = 2.7\text{V to } 6.0\text{V}$	2.55			V	
Logic Low Input Voltage	$V_{IL}$	$V_{DD} = 2.7\text{V to } 6.0\text{V}$			2.0	V	
<b>Off Characteristics - Slew Rate Control Driver</b>							
Supply Input Breakdown Voltage	$BV_{DG}$	$I_{DG} = 10\mu\text{A}, V_{IN} = 0\text{V}, V_{SLEW} = 0\text{V}$	9			V	
Slew Input Breakdown Voltage	$BV_{SLEW}$	$I_{SLEW} = 10\mu\text{A}, V_{IN} = 0\text{V}$	9			V	
Logic Input Breakdown Voltage	$BV_{IN}$	$I_{IN} = 10\mu\text{A}, V_{SLEW} = 0\text{V}$	9			V	
Supply Input Leakage Current	$IR_{DG}$	$V_{DG} = 8\text{V}, V_{IN} = 0\text{V}, V_{SLEW} = 0\text{V}$			100	nA	
Slew Input Leakage Current	$IR_{SLEW}$	$V_{SLEW} = 8\text{V}, V_{IN} = 0\text{V}$			100	nA	
Logic Input Leakage Current	$IR_{IN}$	$V_{IN} = 8\text{V}, V_{SLEW} = 0\text{V}$			100	nA	
<b>On Characteristics - Slew Rate Control Driver</b>							
Gate Current	$I_G$	$V_{IN} = 6\text{V}, V_{GATE} = 2\text{V}$	Slew Pin = Open		90	120	$\mu\text{A}$
			Slew Pin = GND		1	10	$\mu\text{A}$
			Slew Pin = $V_{DD}$		10	50	nA

Notes:  $R_{\theta JA}$  is the sum of the junction-to-case and case-to-ambient thermal resistance where the case thermal reference is defined as the solder mounting surface of the drain pins.  $R_{\theta JC}$  is guaranteed by design while  $R_{\theta CA}$  is determined by the user's board design.

### Electrical Characteristics Cont.

$T_A = 25^\circ\text{C}$  unless otherwise noted

Parameter	Symbol	Conditions	Min.	Typ.	Max.	Units
<b>P-Channel Switching Times</b> ( $V_{\text{SUPPLY}} = 5.5\text{V}$ , $V_{\text{DD}} = 5.5\text{V}$ , Logic IN = 5.5V, $C_{\text{LOAD}} = 510\text{pF}$ , Test Circuit)						
Delay On Time	$t_{\text{dON}}$	Slew Pin = Open		8.3		$\mu\text{s}$
		= GND		0.6		ms
		= $V_{\text{DD}}$		2.2		ms
$V_{\text{OUT}}$ Rise Time	$t_{\text{R}}$	= Open		28		$\mu\text{s}$
		= GND		1.8		ms
		= $V_{\text{DD}}$		11		ms
Output Slew Rate	dv/dt	= Open		162		V/ms
		= GND		26		V/ms
		= $V_{\text{DD}}$		0.3		V/ms

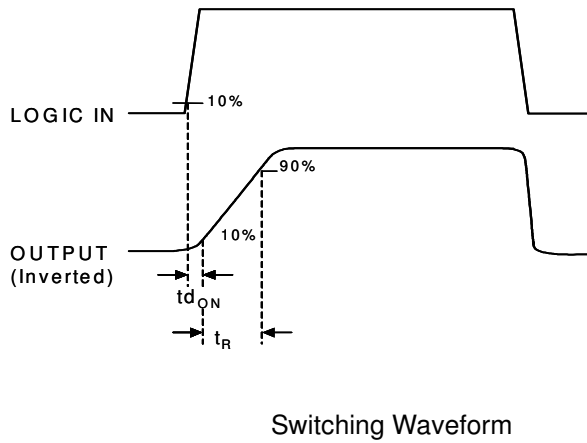
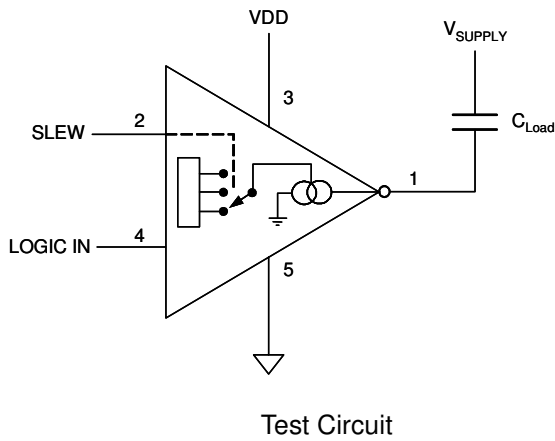

## Typical Characteristics

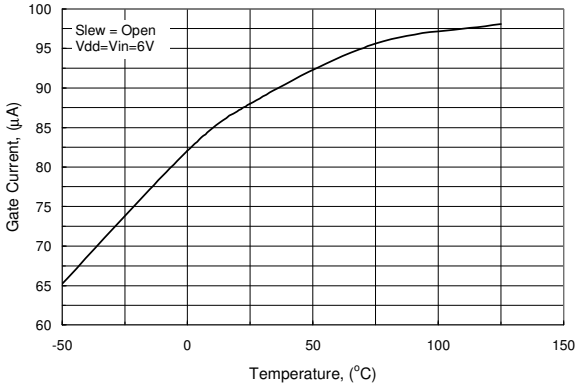

Figure 1. Gate Output Current vs. Temperature (SLEW = OPEN)

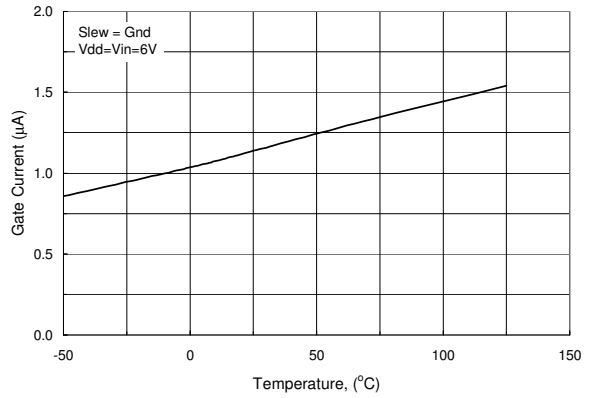

Figure 2. Gate Output Current vs. Temperature (SLEW = GROUND)

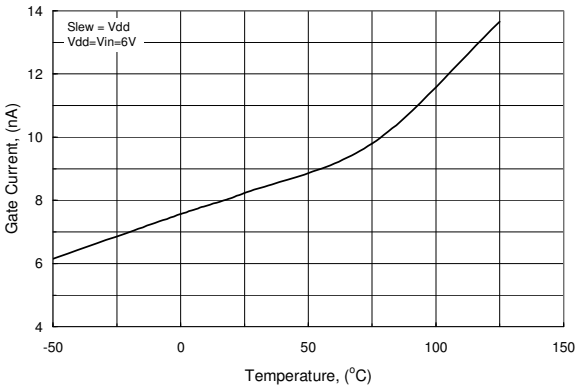

Figure 3. Gate Output Current vs. Temperature (SLEW = V<sub>DD</sub>)

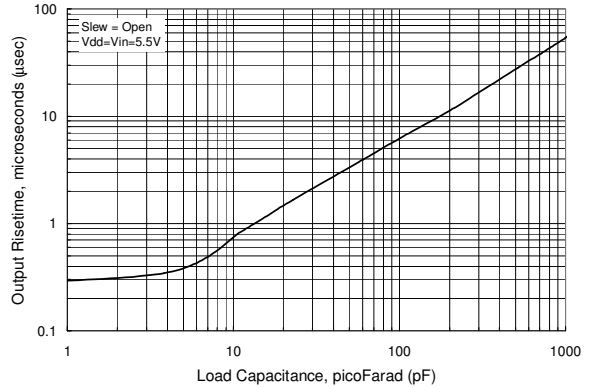

Figure 4.  $t_{RISE}$  vs. Load Capacitance (SLEW = OPEN)

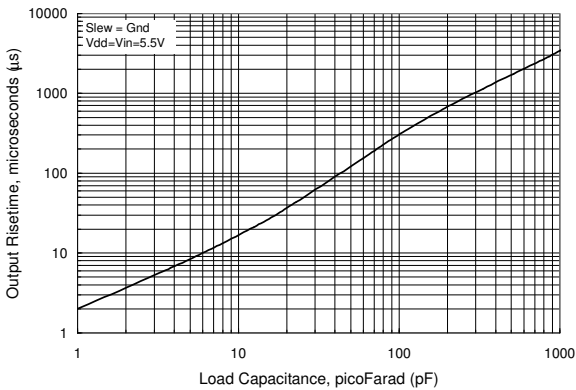

Figure 5.  $t_{RISE}$  vs. Load Capacitance (SLEW = GROUND)

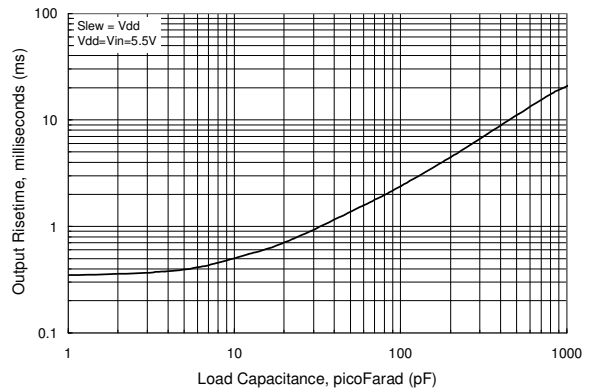

Figure 6.  $t_{RISE}$  vs. Load Capacitance (SLEW = V<sub>DD</sub>)

## Typical Characteristics

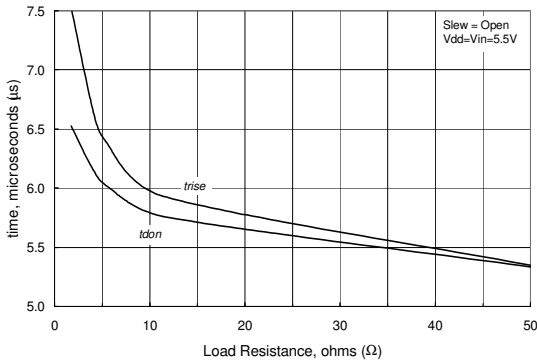

Figure 7. Switching Time vs. Load Resistance (SLEW = OPEN)

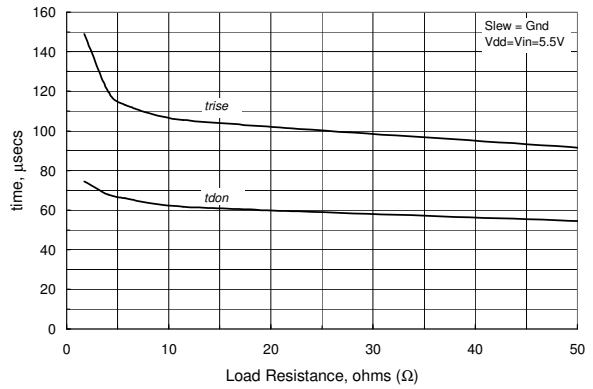

Figure 8. Switching Time vs. Load Resistance (SLEW = GROUND)

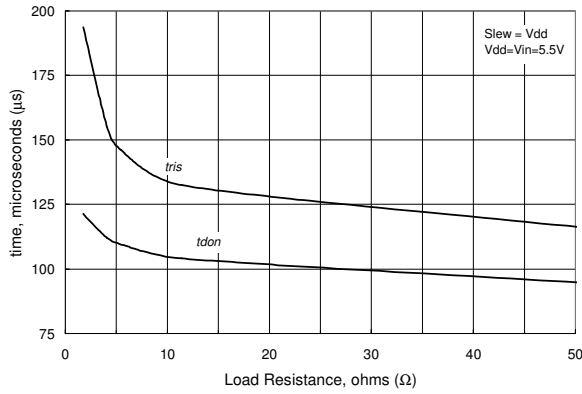

Figure 9. Switching Time vs. Load Resistance (SLEW =  $V_{DD}$ )

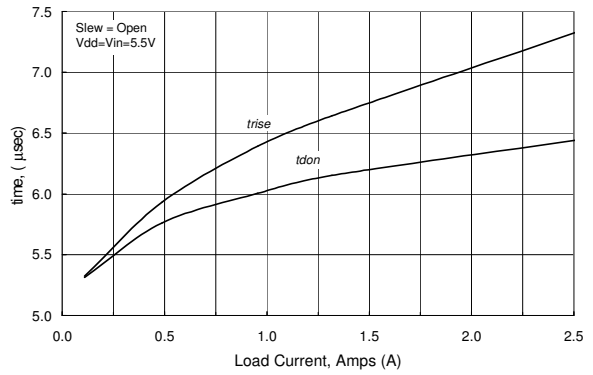

Figure 10. Switching Time vs. Load Current (SLEW = OPEN)

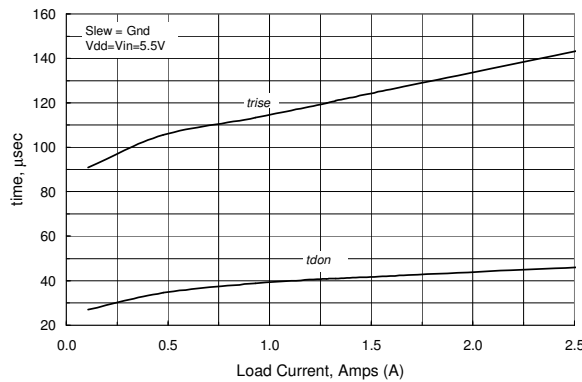

Figure 11. Switching Time vs. Load Current (SLEW = GROUND)

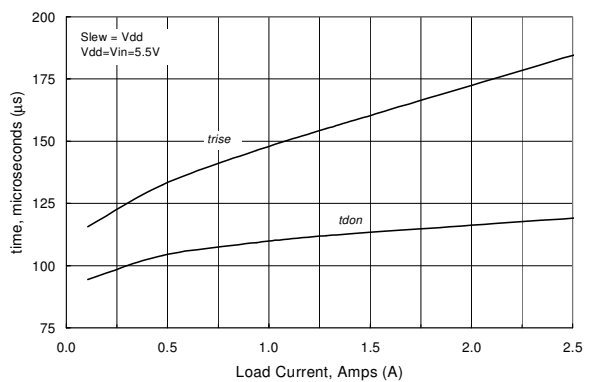
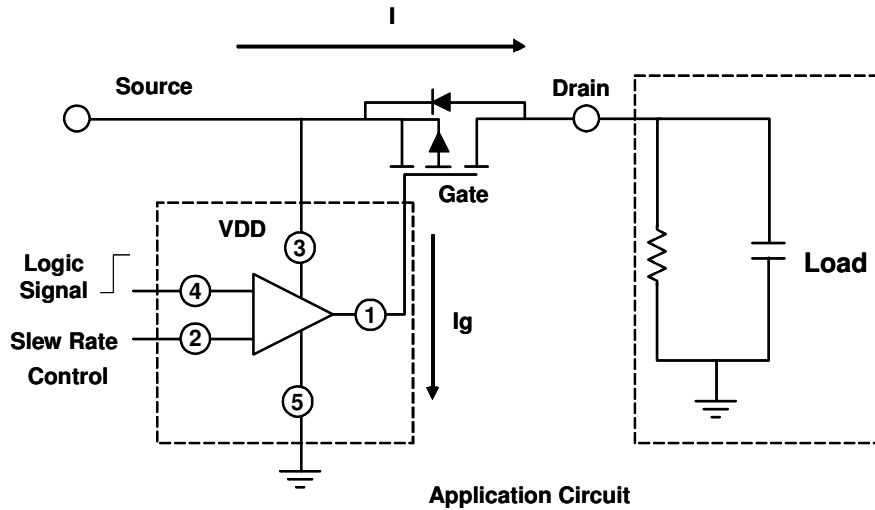

Figure 12. Switching Time vs. Load Current (SLEW =  $V_{DD}$ )

## Application Information

### Typical Application



Battery powered systems make extensive usage of load switching, turning the power to subsystems off, in order to extend battery life. Power MOSFETs are used to accomplish this task. In PDA's and Cell phones, these MOSFETs are usually low threshold P-Channels. Since the loads typically include bypass capacitor components (high capacitive component), a high inrush current can occur when the load is switched on. This inrush current can cause transients on the main power supply disturbing circuitry supplied by it.

The simplest method of limiting the inrush current is to control the slew rate of the MOSFET switch. This can be done with external R/C circuits, but this approach can occupy significant PCB area, and involves other compromises in performance. The slew rate control driver IC FDG901D is specifically designed to interface low voltage digital circuitry with power MOSFETs and reduce the rapid inrush current in load switch applications. The IC limits inrush current by controlling the current, which drives the gate of the P-Channel MOSFET switch.

The control input is a CMOS compatible input with a minimum high input voltage of 2.55V with a power rail voltage of 6V. Therefore, it is compatible with any CMOS logic voltages between 2.55V and 5V and under these conditions there is no additional configuration required.

The Slew Rate Control Driver (FDG901D) is designed to give a programmed choice of one of three steady  $dv/dt$  states on the output during turn-on. To change the  $dv/dt$  value, the user needs to use the Slew Rate Control Pin (Pin 2). To utilize the smallest current setting ( 10 nA) from the IC, a voltage equal to  $V_{DD}$  must be applied to the Slew Rate Control Pin 2. To use the next higher current setting ( ~1 $\mu$ A) a voltage equal to Ground must be applied to Pin 2. To achieve the highest current setting ( ~80 $\mu$ A) or obtain a faster switching speed, the Slew Rate Pin2 must be open (floating). A higher value of capacitance will result in a slower switching rate. To determine the switching times of each setting use the simple equation:

$$t = \frac{Q_g}{I_G}$$

where  $Q_g$  is the Gate charge in nC for a given MOSFET and  $I_G$  is the gate current controlled by the slew rate pin.

Below is a captured image from an oscilloscope depicting the device response. The FDG901D was connected to control an FDG258P P-Channel DMOS. The Slew Rate control pin was set to open (floating state).

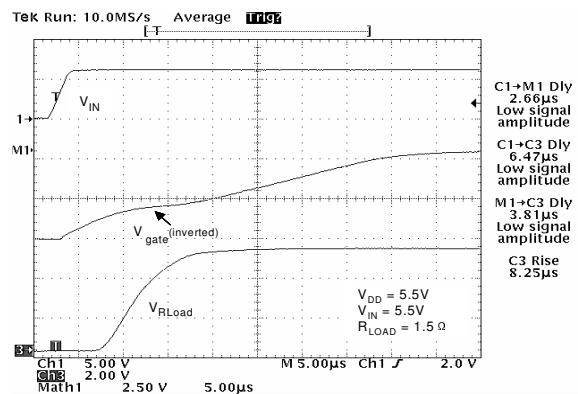

Circuit waveforms for an FDG901D controlling a P-Channel FDG258P MOFET

**Dimensional Outline and Pad Layout**

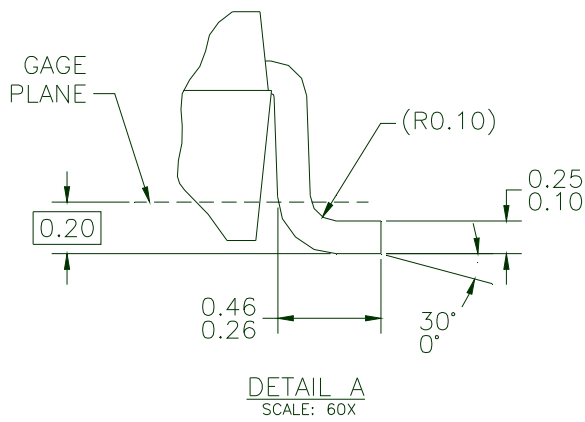
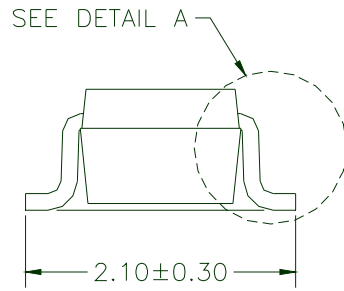
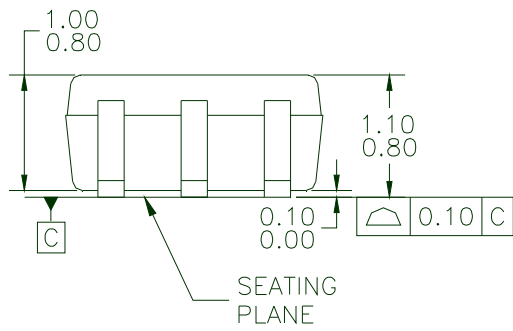
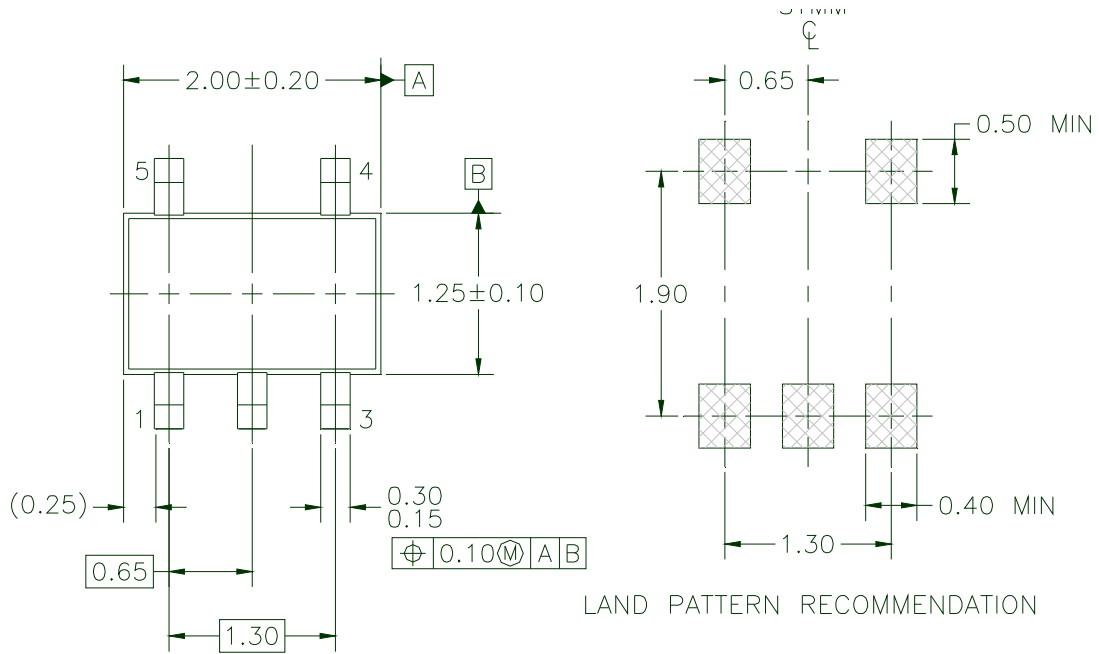

NOTES: UNLESS OTHERWISE SPECIFIED



- A) THIS PACKAGE CONFORMS TO EIAJ SC-88A, 1996.
- B) ALL DIMENSIONS ARE IN MILLIMETERS.
- C) DIMENSIONS DO NOT INCLUDE BURRS OR MOLD FLASH.

DETAIL A  
SCALE: 60X



## TRADEMARKS

The following includes registered and unregistered trademarks and service marks, owned by Fairchild Semiconductor and/or its global subsidiaries, and is not intended to be an exhaustive list of all such trademarks.

ACEx <sup>®</sup>	FPS <sup>™</sup>	PDP-SPM <sup>™</sup>	SupreMOS <sup>™</sup>
Build it Now <sup>™</sup>	FRFET <sup>®</sup>	Power220 <sup>®</sup>	SyncFET <sup>™</sup>
CorePLUS <sup>™</sup>	Global Power Resource <sup>SM</sup>	POWEREDGE <sup>®</sup>	SYSTEM <sup>®</sup>
CROSSVOLT <sup>™</sup>	Green FPS <sup>™</sup>	Power-SPM <sup>™</sup>	GENERAL
CTL <sup>™</sup>	Green FPS <sup>™</sup> e-Series <sup>™</sup>	PowerTrench <sup>®</sup>	The Power Franchise <sup>®</sup>
Current Transfer Logic <sup>™</sup>	GTO <sup>™</sup>	Programmable Active Droop <sup>™</sup>	power <sup>®</sup>
EcoSPARK <sup>®</sup>	i-Lo <sup>™</sup>	QFET <sup>®</sup>	the
EZSWITCH <sup>™</sup> *	IntelliMAX <sup>™</sup>	QS <sup>™</sup>	franchise
	ISOPLANAR <sup>™</sup>	QT Optoelectronics <sup>™</sup>	TinyBoost <sup>™</sup>
	MegaBuck <sup>™</sup>	Quiet Series <sup>™</sup>	TinyBuck <sup>™</sup>
Fairchild <sup>®</sup>	MICROCOUPLER <sup>™</sup>	RapidConfigure <sup>™</sup>	TinyLogic <sup>®</sup>
Fairchild Semiconductor <sup>®</sup>	MicroFET <sup>™</sup>	SMART START <sup>™</sup>	TINYOPTO <sup>™</sup>
FACT Quiet Series <sup>™</sup>	MicroPak <sup>™</sup>	SPM <sup>®</sup>	TinyPower <sup>™</sup>
FACT <sup>®</sup>	MillerDrive <sup>™</sup>	STEALTH <sup>™</sup>	TinyPWM <sup>™</sup>
FAST <sup>®</sup>	Motion-SPM <sup>™</sup>	SuperFET <sup>™</sup>	TinyWire <sup>™</sup>
FastvCore <sup>™</sup>	OPTOLOGIC <sup>®</sup>	SuperSOT <sup>™</sup> -3	µSerDes <sup>™</sup>
FlashWriter <sup>®</sup> *	OPTOPLANAR <sup>®</sup>	SuperSOT <sup>™</sup> -6	UHC <sup>®</sup>
		SuperSOT <sup>™</sup> -8	Ultra FRFET <sup>™</sup>
			UniFET <sup>™</sup>
			VCX <sup>™</sup>

\* EZSWITCH<sup>™</sup> and FlashWriter<sup>®</sup> are trademarks of System General Corporation, used under license by Fairchild Semiconductor.

## DISCLAIMER

FAIRCHILD SEMICONDUCTOR RESERVES THE RIGHT TO MAKE CHANGES WITHOUT FURTHER NOTICE TO ANY PRODUCTS HEREIN TO IMPROVE RELIABILITY, FUNCTION, OR DESIGN. FAIRCHILD DOES NOT ASSUME ANY LIABILITY ARISING OUT OF THE APPLICATION OR USE OF ANY PRODUCT OR CIRCUIT DESCRIBED HEREIN; NEITHER DOES IT CONVEY ANY LICENSE UNDER ITS PATENT RIGHTS, NOR THE RIGHTS OF OTHERS. THESE SPECIFICATIONS DO NOT EXPAND THE TERMS OF FAIRCHILD'S WORLDWIDE TERMS AND CONDITIONS, SPECIFICALLY THE WARRANTY THEREIN, WHICH COVERS THESE PRODUCTS.

## LIFE SUPPORT POLICY

FAIRCHILD'S PRODUCTS ARE NOT AUTHORIZED FOR USE AS CRITICAL COMPONENTS IN LIFE SUPPORT DEVICES OR SYSTEMS WITHOUT THE EXPRESS WRITTEN APPROVAL OF FAIRCHILD SEMICONDUCTOR CORPORATION.

As used herein:

1. Life support devices or systems are devices or systems which, (a) are intended for surgical implant into the body or (b) support or sustain life, and (c) whose failure to perform when properly used in accordance with instructions for use provided in the labeling, can be reasonably expected to result in a significant injury of the user.
2. A critical component in any component of a life support, device, or system whose failure to perform can be reasonably expected to cause the failure of the life support device or system, or to affect its safety or effectiveness.

## PRODUCT STATUS DEFINITIONS

### Definition of Terms

Datasheet Identification	Product Status	Definition
Advance Information	Formative or In Design	This datasheet contains the design specifications for product development. Specifications may change in any manner without notice.
Preliminary	First Production	This datasheet contains preliminary data; supplementary data will be published at a later date. Fairchild Semiconductor reserves the right to make changes at any time without notice to improve design.
No Identification Needed	Full Production	This datasheet contains final specifications. Fairchild Semiconductor reserves the right to make changes at any time without notice to improve the design.
Obsolete	Not In Production	This datasheet contains specifications on a product that has been discontinued by Fairchild Semiconductor. The datasheet is printed for reference information only.

Rev. I33



Компания «Life Electronics» занимается поставками электронных компонентов импортного и отечественного производства от производителей и со складов крупных дистрибьюторов Европы, Америки и Азии.

С конца 2013 года компания активно расширяет линейку поставок компонентов по направлению коаксиальный кабель, кварцевые генераторы и конденсаторы (керамические, пленочные, электролитические), за счёт заключения дистрибьюторских договоров

Мы предлагаем:

- Конкурентоспособные цены и скидки постоянным клиентам.
- Специальные условия для постоянных клиентов.
- Подбор аналогов.
- Поставку компонентов в любых объемах, удовлетворяющих вашим потребностям.
- Приемлемые сроки поставки, возможна ускоренная поставка.
- Доставку товара в любую точку России и стран СНГ.
- Комплексную поставку.
- Работу по проектам и поставку образцов.
- Формирование склада под заказчика.
- Сертификаты соответствия на поставляемую продукцию (по желанию клиента).
- Тестирование поставляемой продукции.
- Поставку компонентов, требующих военную и космическую приемку.
- Входной контроль качества.
- Наличие сертификата ISO.

В составе нашей компании организован Конструкторский отдел, призванный помогать разработчикам, и инженерам.

Конструкторский отдел помогает осуществить:

- Регистрацию проекта у производителя компонентов.
- Техническую поддержку проекта.
- Защиту от снятия компонента с производства.
- Оценку стоимости проекта по компонентам.
- Изготовление тестовой платы монтаж и пусконаладочные работы.



Тел: +7 (812) 336 43 04 (многоканальный)

Email: [org@lifeelectronics.ru](mailto:org@lifeelectronics.ru)