

## Main

Range of product	Interface for discrete signals
Product or component type	Slim electromechanical output interface module
Contacts type and composition	1 NO
[Uc] control circuit voltage	24 V
Control circuit type	DC
Width pitch dimension	0.47 in (12 mm)
Line Rated Current	<= 28 mA
Short-circuit protection	6.3 A external fuse fast blow (Ik <= 1 kA AC and Ik <= 100 A DC)
[Ith] conventional free air thermal current	5 A conforming to IEC 60947-1
Local signalling	Green mechanical indicator for position of contacts and 1 green LED control signal state
Sale per indivisible quantity	5

## Complementary

Control circuit voltage limits	28.8 V energization threshold: 16.9 V
Connections - terminals	Screw clamp terminal
Drop-out voltage	3.8 V
Holding current	2 mA
Power dissipation in W	0.64 W
Maximum switching voltage	150 V DC 250 V AC
System Voltage	<= 120 V DC conforming to IEC 60947-5-1 <= 230 V AC conforming to IEC 60947-5-1
Network frequency	50/60 Hz
[Ie] rated operational current	1 A AC-14 Ue: 230 V per 1000000 cycles conforming to IEC 60947-5-1 1 A AC-15 Ue: 230 V per 1000000 cycles conforming to IEC 60947-5-1 3 A AC-12 Ue: 230 V per 1000000 cycles conforming to IEC 60947-5-1 1.5 A DC-13 Ue: 24 V per 1000000 cycles conforming to IEC 60947-5-1 1.7 A DC-12 Ue: 24 V per 1000000 cycles conforming to IEC 60947-5-1
Minimum switching current	5 mA
Minimum switching voltage	5 V
Electrical reliability	<= 0.00000001
Operating time	<= 10 ms between energisation of coil and closing of NO contact DC <= 12 ms between de-energisation of coil and closing of NO contact DC
Contact bounce time	<= 5 ms
Operating rate in Hz	10 Hz at no-load 0.5 Hz at le
Mechanical durability	10000000 cycles
[Ui] rated insulation voltage	250 V conforming to VDE 0110 group C 300 V conforming to IEC 60947-1
Flame retardance	V0 conforming to UL 94
Cable cross section	0...0.01 in <sup>2</sup> (0.27...4 mm <sup>2</sup> ), 1 wire rigid 0...0 in <sup>2</sup> (0.34...2.5 mm <sup>2</sup> ), 1 or 2 wires flexible with cable end 0...0 in <sup>2</sup> (0.34...2.5 mm <sup>2</sup> ), 1 or 2 wires flexible with cable end 0...0 in <sup>2</sup> (0.6...2.5 mm <sup>2</sup> ), 1 or 2 wires flexible without cable end
Operating position	Any position
Installation category	II conforming to IEC 60947-1
Mounting support	Asymmetrical DIN rail Combination rail Symmetrical DIN rail
Product weight	0.09 lb(US) (0.041 kg)

The information provided in this documentation contains general descriptions and/or technical characteristics of the products contained herein. This documentation is not intended as a substitute for and is not to be used for determining suitability or reliability of these products for specific user applications. It is the duty of any such user or integrator to perform the appropriate and complete risk analysis, evaluation and testing of the products with respect to the relevant specific application or use thereof. Neither Schneider Electric Industries SAS nor any of its affiliates or subsidiaries shall be responsible or liable for misuse of the information contained herein.

## Environment

immunity to microbreaks	1 ms
dielectric strength	1000 V for 1 minute between open contacts 2500 V for 1 minute between wired interface and earth 4000 V for 1 minute between coil circuit and contact circuits
standards	IEC 60947-5-1
product certifications	BV CSA DNV LROS (Lloyds register of shipping) UL
IP degree of protection	IP20 conforming to IEC 60529
protective treatment	TC
fire resistance	1760 °F (960 °C) conforming to IEC 60695-2-1
shock resistance	30 gn 11 ms conforming to IEC 60068-2-27
vibration resistance	3 gn (f = 10...150 Hz) conforming to IEC 60068-2-6
electromagnetic compatibility	1.2/50 µs shock waves immunity test, 0.5 kV for U < 50 V conforming to IEC 60947-1 1.2/50 µs shock waves immunity test, 1.5 kV for U < 150 V conforming to IEC 60947-1 1.2/50 µs shock waves immunity test, 2.5 kV for U < 300 V conforming to IEC 60947-1 Electromagnetic field immunity test level 3, 10 V/m between 27...1000 MHz conforming to IEC 61000-4-3 Electromagnetic field immunity test level 3, 10 V/m between 27...1000 MHz conforming to IEC 61000-4-3 Electrostatic discharge immunity test level 3, 8 kV conforming to IEC 61000-4-2 Fast transients immunity test level 3, on input/output 1 kV conforming to IEC 61000-4-4 Fast transients immunity test level 3, on power supply 2 kV conforming to IEC 61000-4-4
ambient air temperature for operation	23...104 °F (-5...40 °C) unrestricted operation 23...131 °F (-5...55 °C) from 0.85...1.1 Us -13...131 °F (-25...55 °C) at Us -13...158 °F (-25...70 °C) at Us with 8 mm space between ABR2S1...
ambient air temperature for storage	-40...176 °F (-40...80 °C)
operating altitude	<= 9842.52 ft (3000 m)
pollution degree	2 conforming to IEC 60947-1

## Offer Sustainability

WARNING: This product can expose you to chemicals including:	WARNING: This product can expose you to chemicals including:
Lead and lead compounds, which is known to the State of California to cause cancer and birth defects or other reproductive harm.	Lead and lead compounds, which is known to the State of California to cause cancer and birth defects or other reproductive harm.
For more information go to <a href="http://www.p65warnings.ca.gov">www.p65warnings.ca.gov</a>	For more information go to <a href="http://www.p65warnings.ca.gov">www.p65warnings.ca.gov</a>

## Contractual warranty

Warranty period	18 months
-----------------	-----------

## Slim Electromechanical Interface Module

### Dimensions

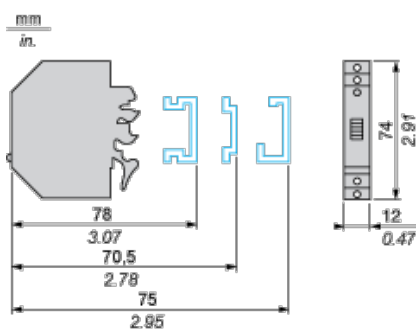

## Slim Electromechanical Interface Module

### Example of Application with PLC

Interfacing PLC discrete outputs

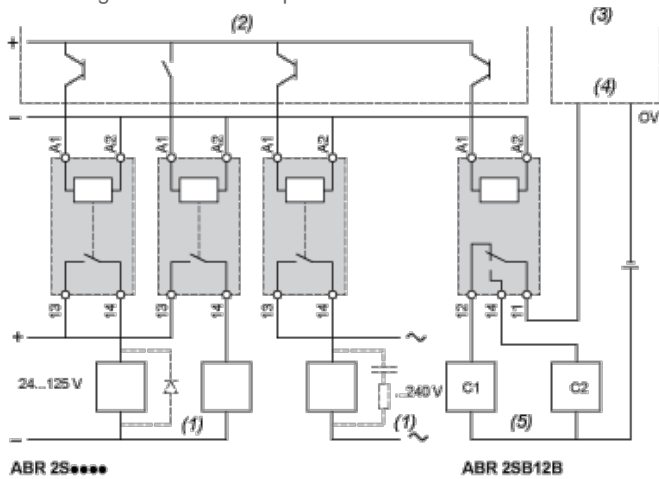

- (1) Essential on inductive loads (can be replaced with peak limiter)
- (2) PLC positive logic transistor (or relay) outputs
- (3) PLC analog inputs
- (4) Channel X
- (5) Analog sensors

## Slim Electromechanical Interface Module

### Circuit Diagram

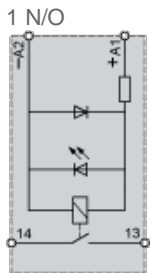

## Electrical Durability of Contacts

### AC Loads

Test conditions: in accordance with standard IEC 947-5-1 set up for rated control voltage.

AC-12 operating cycles in millions

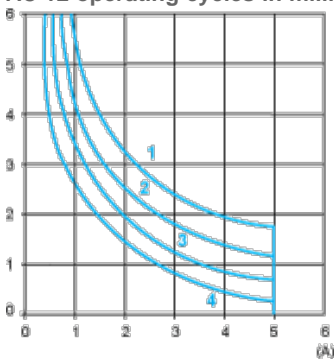

AC-12 Control of resistive loads and isolated solid state loads via optocoupler ( $\cos \phi \geq 0.9$ )

12

- (1) 24 V
- (2) 48 V
- (3) 115 V
- (4) 230 V

### AC-14 and AC-15 operating cycles in millions

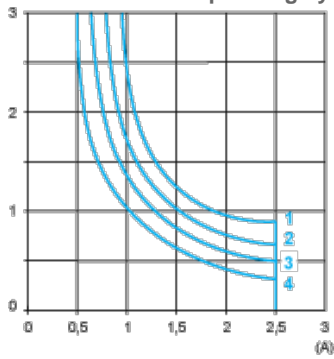

AC-14 Control of weak electro-magnetic loads of electro-magnets  $\leq 72$  VA (make:  $\cos \phi = 0.3$ , break:  $\cos \phi = 0.3$ )

AC-15 Control of electro-magnetic loads of electro-magnets  $> 72$  VA (make:  $\cos \phi = 0.7$ , break:  $\cos \phi = 0.4$ )

- (1) 24 V
- (2) 48 V
- (3) 115 V
- (4) 230 V

### DC Loads

Test conditions: in accordance with standard IEC 947-5-1 set up for rated control voltage.

### DC-12 operating cycles in millions

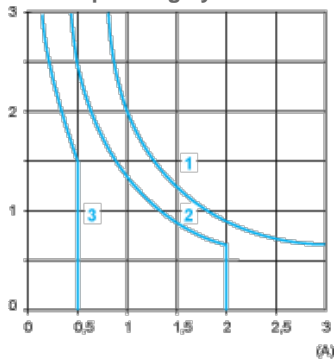

DC-12 Control of resistive loads and isolated solid state loads via optocoupler ( $L/R \leq 1$  ms)

- (1) 24 V
- (2) 48 V
- (3) 115 V

### DC-13 operating cycles in millions

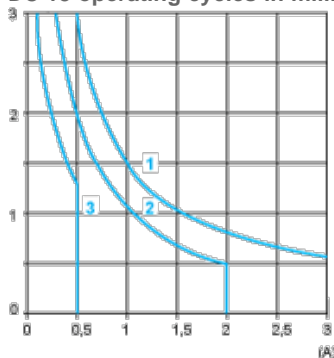

DC-13 Control of electro-magnets ( $L/R \leq 2 \times (U_e \times I_e)$  in ms, with  $U_e$ : rated operating voltage and  $I_e$ : rated operating current, with a load protection diode)

- (1) 24 V
- (2) 48 V
- (3) 115 V

Компания «Life Electronics» занимается поставками электронных компонентов импортного и отечественного производства от производителей и со складов крупных дистрибьюторов Европы, Америки и Азии.

С конца 2013 года компания активно расширяет линейку поставок компонентов по направлению коаксиальный кабель, кварцевые генераторы и конденсаторы (керамические, пленочные, электролитические), за счёт заключения дистрибьюторских договоров

Мы предлагаем:

- Конкурентоспособные цены и скидки постоянным клиентам.
- Специальные условия для постоянных клиентов.
- Подбор аналогов.
- Поставку компонентов в любых объемах, удовлетворяющих вашим потребностям.
- Приемлемые сроки поставки, возможна ускоренная поставка.
- Доставку товара в любую точку России и стран СНГ.
- Комплексную поставку.
- Работу по проектам и поставку образцов.
- Формирование склада под заказчика.
- Сертификаты соответствия на поставляемую продукцию (по желанию клиента).
- Тестирование поставляемой продукции.
- Поставку компонентов, требующих военную и космическую приемку.
- Входной контроль качества.
- Наличие сертификата ISO.

В составе нашей компании организован Конструкторский отдел, призванный помогать разработчикам, и инженерам.

Конструкторский отдел помогает осуществить:

- Регистрацию проекта у производителя компонентов.
- Техническую поддержку проекта.
- Защиту от снятия компонента с производства.
- Оценку стоимости проекта по компонентам.
- Изготовление тестовой платы монтаж и пусконаладочные работы.



Тел: +7 (812) 336 43 04 (многоканальный)

Email: [org@lifeelectronics.ru](mailto:org@lifeelectronics.ru)