

## High temperature 40 A SCRs

Datasheet - production data

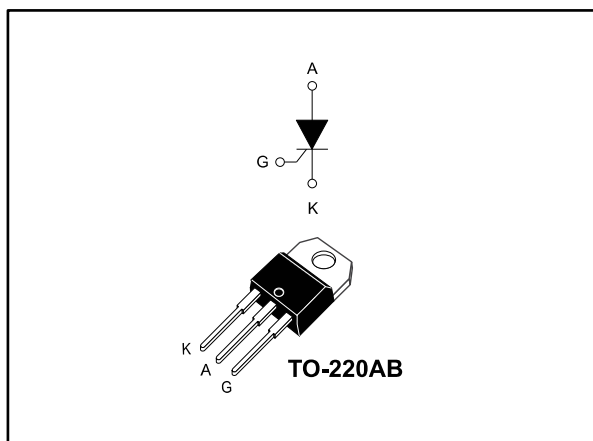

### Features

- High junction temperature:  $T_j = 150\text{ }^\circ\text{C}$
- High noise immunity  $dV/dt = 500\text{ V}/\mu\text{s}$  up to  $150\text{ }^\circ\text{C}$
- Gate triggering current  $I_{GT} = 15\text{ mA}$
- Peak off-state voltage  $600\text{ V } V_{DRM}/V_{RRM}$
- High turn on current rise  $dI/dt = 100\text{ A}/\mu\text{s}$
- ECOPACK<sup>®</sup>2 compliant component
- Insulated package TO-220AB:
  - Insulated voltage:  $2500\text{ V}_{RMS}$
- Complies with UL 1557 (File ref : E81734)

### Applications

- Motorbike voltage regulator circuits
- Inrush current limiting circuit
- Motor control circuits and starters
- Solid state relays

### Description

Thanks to its junction temperature  $T_j$  up to  $150\text{ }^\circ\text{C}$ , the device offers high thermal performances operation up to  $40\text{ A}$ . It is fully tab insulated thanks to the ceramic inside the TO-220AB package and allows a back to back configuration.

Its trade-off noise immunity ( $dV/dt = 500\text{ V}/\mu\text{s}$ ) versus its gate triggering current ( $I_{GT} = 15\text{ mA}$ ) and its turn-on current rise ( $dI/dt = 100\text{ A}/\mu\text{s}$ ) allows to design robust and compact control circuit for voltage regulator in motorbikes and industrial drives, overvoltage crowbar protection, motor control circuits in power tools and kitchen aids, inrush current limiting circuits.

**Table 1: Device summary**

Order code	Package	$V_{DRM}/V_{RRM}$	$I_{GT}$
TN4015H-6I	TO-220AB ins.	600 V	15 mA

# 1 Characteristics

**Table 2: Absolute maximum ratings (limiting values),  $T_j = 25\text{ °C}$  unless otherwise specified**

Symbol	Parameter		Value	Unit
$I_{T(RMS)}$	RMS on-state current (180 ° conduction angle)		$T_c = 82\text{ °C}$ 40	A
$I_{T(AV)}$	Average on-state current (180 ° conduction angle)		$T_c = 83\text{ °C}$ 25	A
			$T_c = 94\text{ °C}$ 22	
			$T_c = 101\text{ °C}$ 20	
$I_{TSM}$	Non repetitive surge peak on-state current		$t_p = 8.3\text{ ms}$ 394	A
			$t_p = 10\text{ ms}$ 360	
$I^2t$	$I^2t$ value for fusing		$t_p = 10\text{ ms}$ 648	$A^2s$
$di/dt$	Critical rate of rise of on-state current $I_G = 2 \times I_{GT}$ , $t_r \leq 100\text{ ns}$		$f = 60\text{ Hz}$ 100	$A/\mu s$
$V_{DRM}/V_{RRM}$	Repetitive peak off-state voltage		$T_j = 150\text{ °C}$ 600	V
$V_{DSM}/V_{RSM}$	Non repetitive surge peak off-state voltage		$t_p = 10\text{ ms}$ $V_{DRM}/V_{RRM} + 100$	V
$I_{GM}$	Peak gate current	$t_p = 20\text{ }\mu s$	$T_j = 150\text{ °C}$ 4	A
$P_{G(AV)}$	Average gate power dissipation		$T_j = 150\text{ °C}$ 1	W
$V_{RGM}$	Maximum peak reverse gate voltage		5	V
$T_{stg}$	Storage junction temperature range		-40 to +150	$^{\circ}C$
$T_j$	Maximum operating junction temperature		-40 to +150	$^{\circ}C$
$T_L$	Maximum lead temperature soldering during 10 s		260	$^{\circ}C$

**Table 3: Electrical characteristics ( $T_j = 25\text{ °C}$  unless otherwise specified)**

Symbol	Test Conditions		Value	Unit	
$I_{GT}$	$V_D = 12\text{ V}$ , $R_L = 33\text{ }\Omega$		Max.	15	mA
$V_{GT}$			Max.	1.3	V
$V_{GD}$	$V_D = V_{DRM}$ , $R_L = 3.3\text{ k}\Omega$	$T_j = 150\text{ °C}$	Min.	0.15	V
$I_H$	$I_T = 500\text{ mA}$ , gate open		Max.	60	mA
$I_L$	$I_G = 1.2 \times I_{GT}$		Max.	80	mA
$dV/dt$	$V_D = 402\text{ V}$ , gate open	$T_j = 150\text{ °C}$	Min.	500	$V/\mu s$
$t_{gt}$	$I_T = 80\text{ A}$ , $V_D = 600\text{ V}$ , $I_G = 100\text{ mA}$ , $(dI_G/dt)_{max} = 0.2\text{ A}/\mu s$		Typ.	1.9	$\mu s$
$t_q$	$V_D = 402\text{ V}$ , $I_T = 40\text{ A}$ , $V_R = 25\text{ V}$ , $dV_D/dt = 50\text{ V}/\mu s$ , $(dI_G/dt)_{max} = 30\text{ A}/\mu s$	$T_j = 150\text{ °C}$	Typ.	85	$\mu s$

Table 4: Static characteristics

Symbol	Test conditions			Value	Unit
$V_{TM}$	$I_{TM} = 80 \text{ A}$ , $t_p = 380 \text{ } \mu\text{s}$	$T_j = 25 \text{ }^\circ\text{C}$	Max.	1.6	V
$V_{TO}$	Threshold voltage	$T_j = 150 \text{ }^\circ\text{C}$	Max.	0.85	
$R_D$	Dynamic resistance	$T_j = 150 \text{ }^\circ\text{C}$	Max.	10	m $\Omega$
$I_{DRM}$ , $I_{RRM}$	$V_D = V_{DRM} = V_{RRM}$	$T_j = 25 \text{ }^\circ\text{C}$	Max.	10	$\mu\text{A}$
		$T_j = 150 \text{ }^\circ\text{C}$		6	mA

Table 5: Thermal parameters

Symbol	Parameter		Value	Unit
$R_{th(j-c)}$	Junction to case (DC)	Max.	1.8	$^\circ\text{C/W}$
$R_{th(j-a)}$	Junction to ambient (DC)	Typ.	60	

# 1.1 Characteristics (curves)

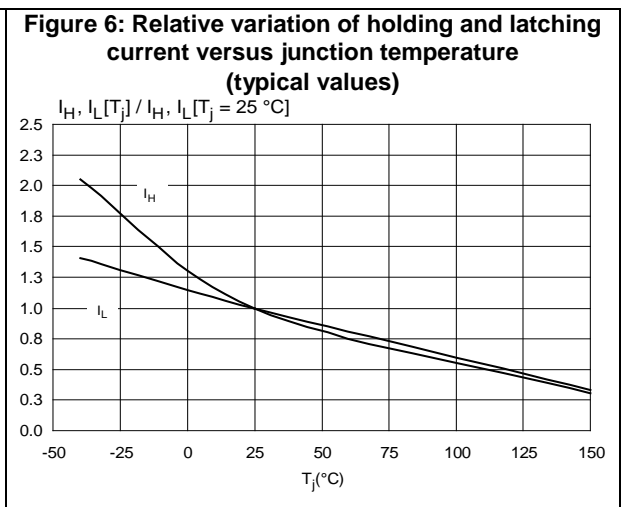
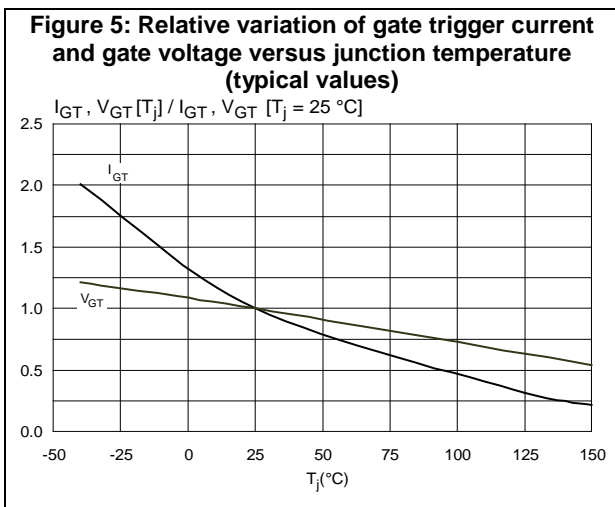
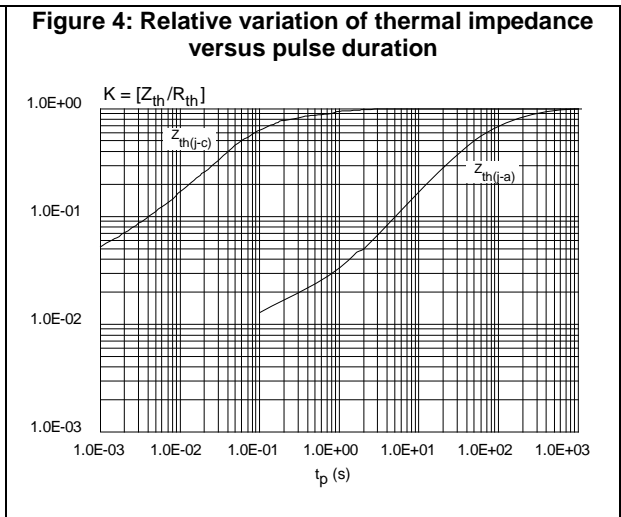
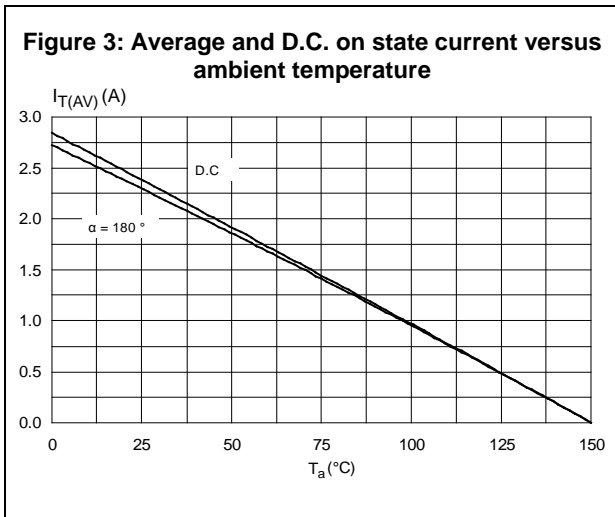
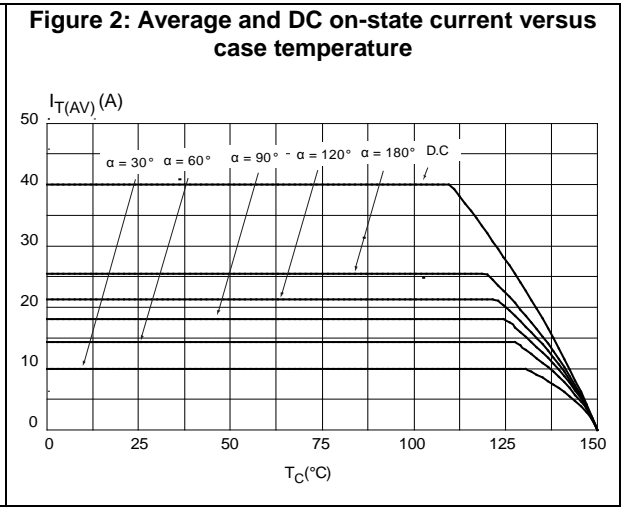
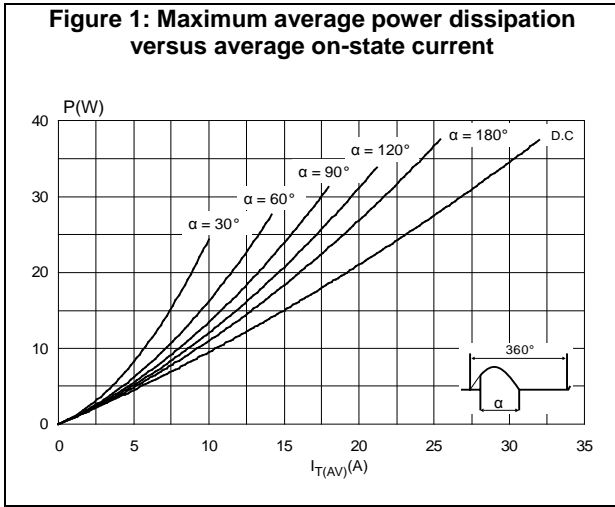

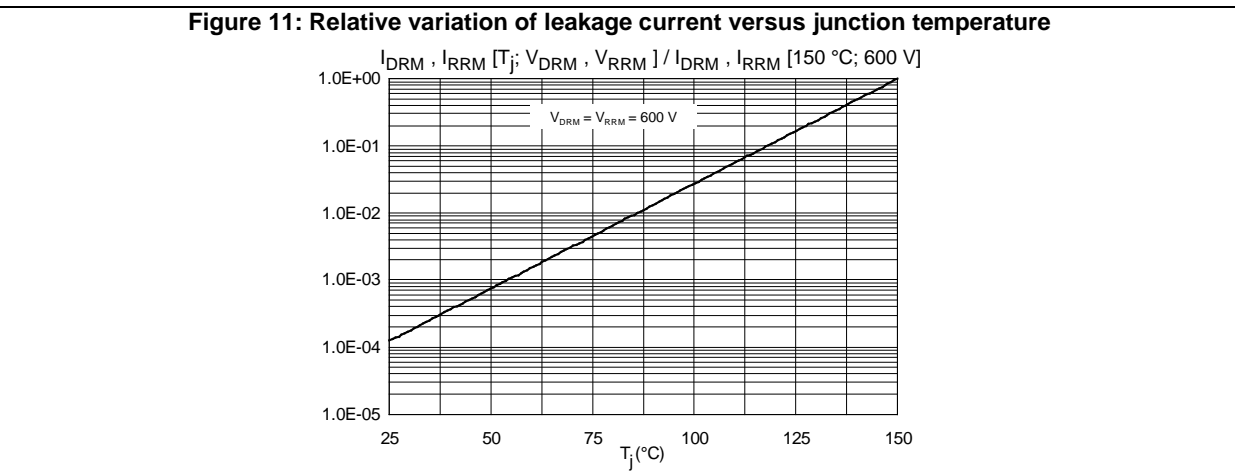
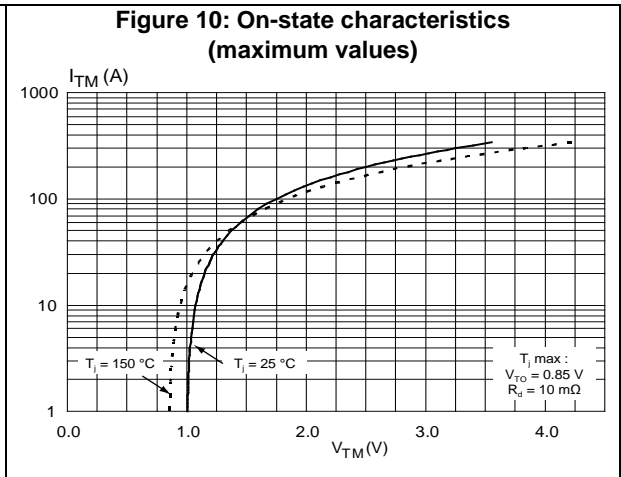
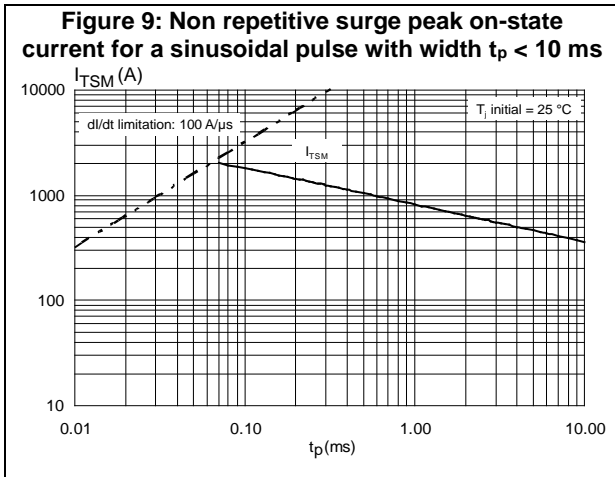
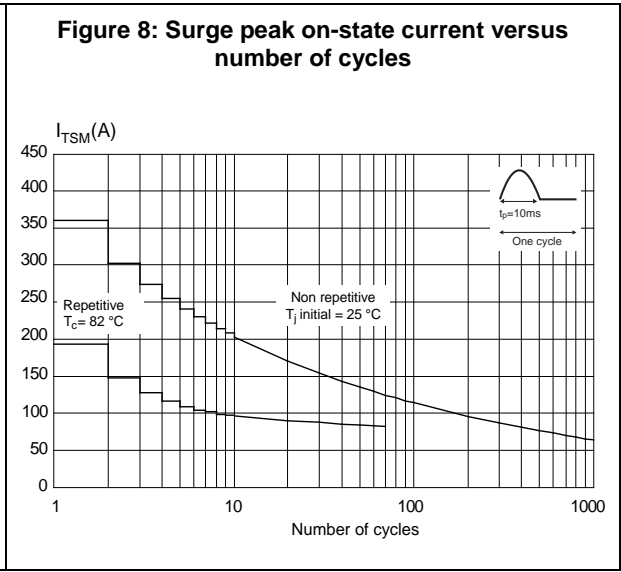
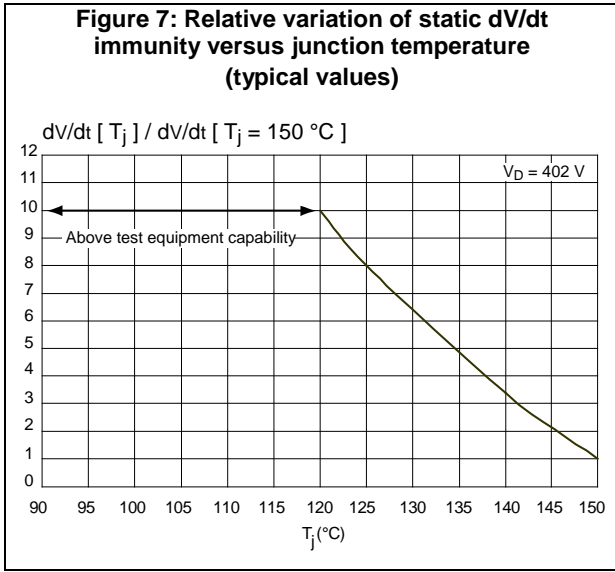

## 2 Package information

In order to meet environmental requirements, ST offers these devices in different grades of ECOPACK® packages, depending on their level of environmental compliance. ECOPACK® specifications, grade definitions and product status are available at: [www.st.com](http://www.st.com). ECOPACK® is an ST trademark.

- Epoxy meets UL94, V0
- Lead-free, halogen-free package

### 2.1 TO-220AB insulated package information

Figure 12: TO-220AB insulated package outline

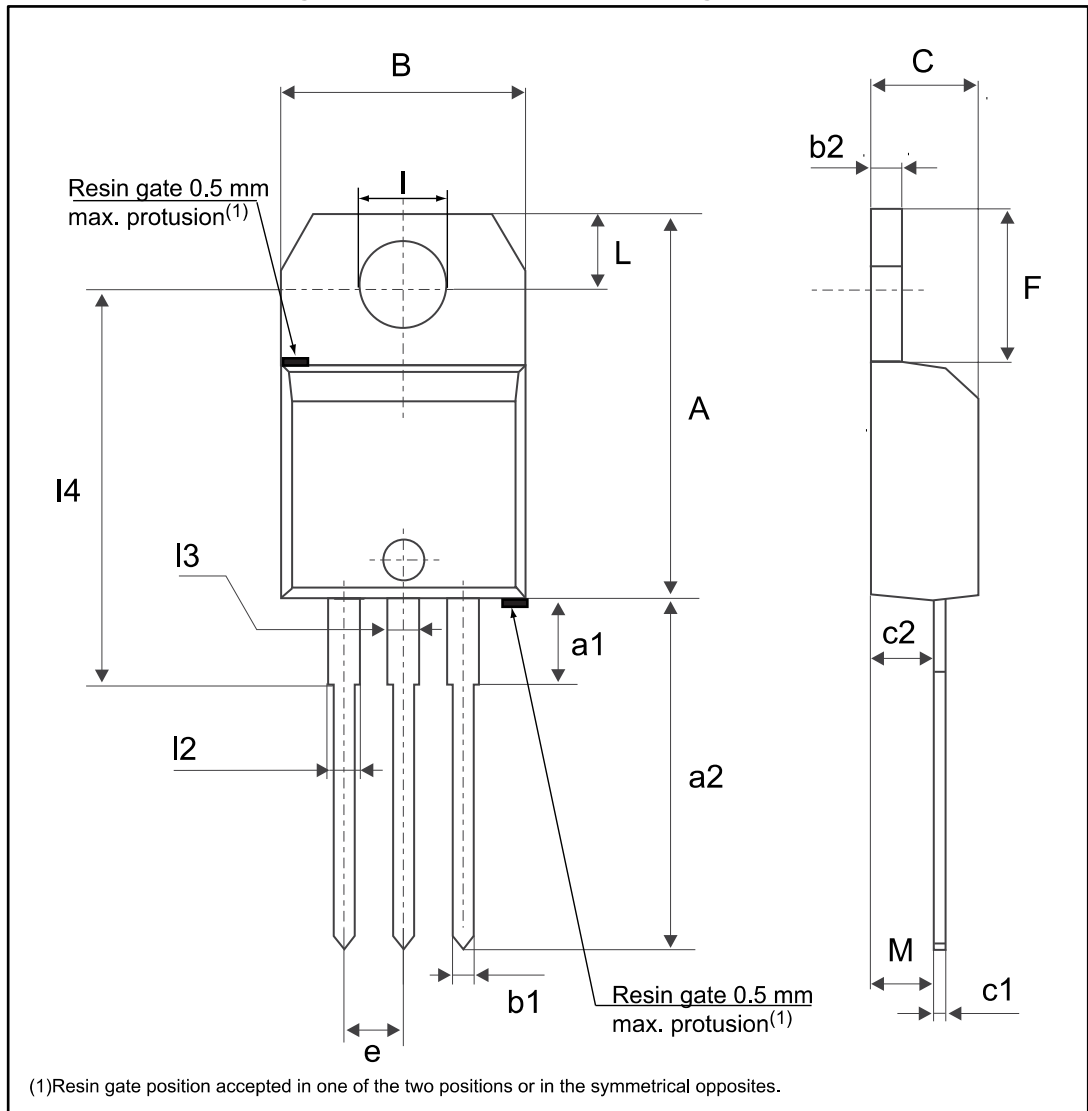

Table 6: TO-220AB insulated package mechanical data

Ref.	Dimensions					
	Millimeters			Inches		
	Min.	Typ.	Max.	Min.	Typ.	Max.
A	15.20		15.90	0.5984		0.6260
a1		3.75			0.1476	
a2	13.00		14.00	0.5118		0.5512
B	10.00		10.4	0.3937		0.4094
b1	0.61		0.88	0.0240		0.0346
b2	1.23		1.32	0.0484		0.0520
C	4.40		4.60	0.1732		0.1811
c1	0.49		0.70	0.0193		0.0276
c2	2.40		2.72	0.0945		0.1071
e	2.40		2.70	0.0945		0.1063
F	6.20		6.60	0.2441		0.2598
ØI	3.73		3.88	0.1469		0.1528
I4	15.80	16.40	16.8	0.6220	0.6457	0.6614
L	2.65		2.95	0.1043		0.1161
I2	1.14		1.70	0.0449		0.0669
I3	1.14		1.70	0.0449		0.0669
M		2.60			0.1024	

### 3 Ordering information

Figure 13: Ordering information scheme

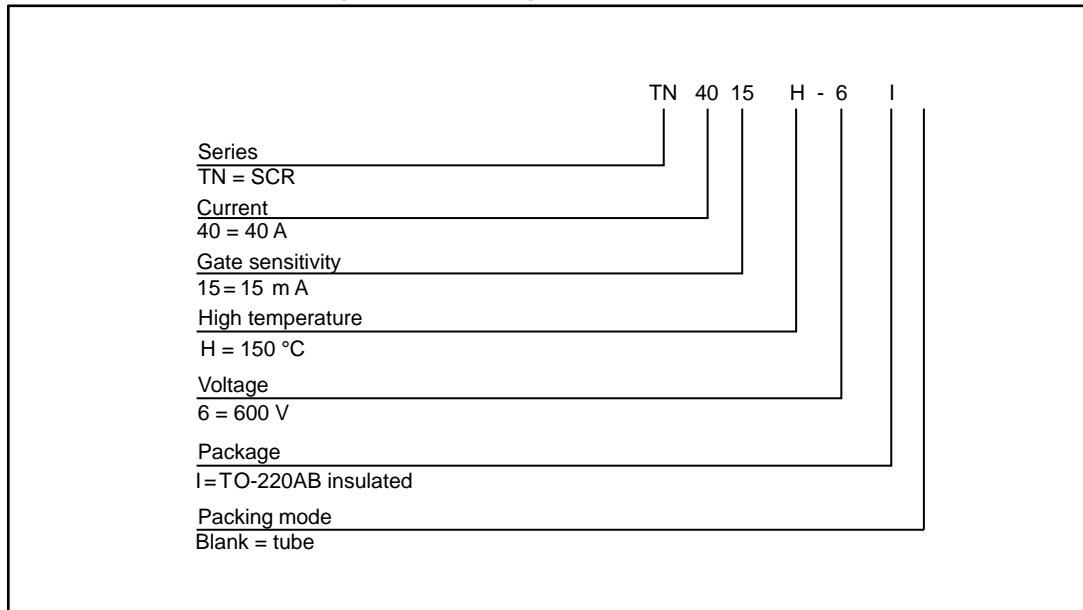

Table 7: Ordering information

Order code	Marking	Package	Weight	Base qty.	Delivery mode
TN4015H-6I	TN4015H6I	TO-220AB Ins.	2.3 g	50	Tube

### 4 Revision history

Table 8: Document revision history

Date	Revision	Changes
05-Oct-2016	1	Initial release.
25-Nov-2016	2	Updated cover image.



**IMPORTANT NOTICE – PLEASE READ CAREFULLY**

STMicroelectronics NV and its subsidiaries ("ST") reserve the right to make changes, corrections, enhancements, modifications, and improvements to ST products and/or to this document at any time without notice. Purchasers should obtain the latest relevant information on ST products before placing orders. ST products are sold pursuant to ST's terms and conditions of sale in place at the time of order acknowledgement.

Purchasers are solely responsible for the choice, selection, and use of ST products and ST assumes no liability for application assistance or the design of Purchasers' products.

No license, express or implied, to any intellectual property right is granted by ST herein.

Resale of ST products with provisions different from the information set forth herein shall void any warranty granted by ST for such product.

ST and the ST logo are trademarks of ST. All other product or service names are the property of their respective owners.

Information in this document supersedes and replaces information previously supplied in any prior versions of this document.

© 2016 STMicroelectronics – All rights reserved

Компания «Life Electronics» занимается поставками электронных компонентов импортного и отечественного производства от производителей и со складов крупных дистрибьюторов Европы, Америки и Азии.

С конца 2013 года компания активно расширяет линейку поставок компонентов по направлению коаксиальный кабель, кварцевые генераторы и конденсаторы (керамические, пленочные, электролитические), за счёт заключения дистрибьюторских договоров

Мы предлагаем:

- Конкурентоспособные цены и скидки постоянным клиентам.
- Специальные условия для постоянных клиентов.
- Подбор аналогов.
- Поставку компонентов в любых объемах, удовлетворяющих вашим потребностям.
- Приемлемые сроки поставки, возможна ускоренная поставка.
- Доставку товара в любую точку России и стран СНГ.
- Комплексную поставку.
- Работу по проектам и поставку образцов.
- Формирование склада под заказчика.
- Сертификаты соответствия на поставляемую продукцию (по желанию клиента).
- Тестирование поставляемой продукции.
- Поставку компонентов, требующих военную и космическую приемку.
- Входной контроль качества.
- Наличие сертификата ISO.

В составе нашей компании организован Конструкторский отдел, призванный помогать разработчикам, и инженерам.

Конструкторский отдел помогает осуществить:

- Регистрацию проекта у производителя компонентов.
- Техническую поддержку проекта.
- Защиту от снятия компонента с производства.
- Оценку стоимости проекта по компонентам.
- Изготовление тестовой платы монтаж и пусконаладочные работы.



Тел: +7 (812) 336 43 04 (многоканальный)

Email: [org@lifeelectronics.ru](mailto:org@lifeelectronics.ru)